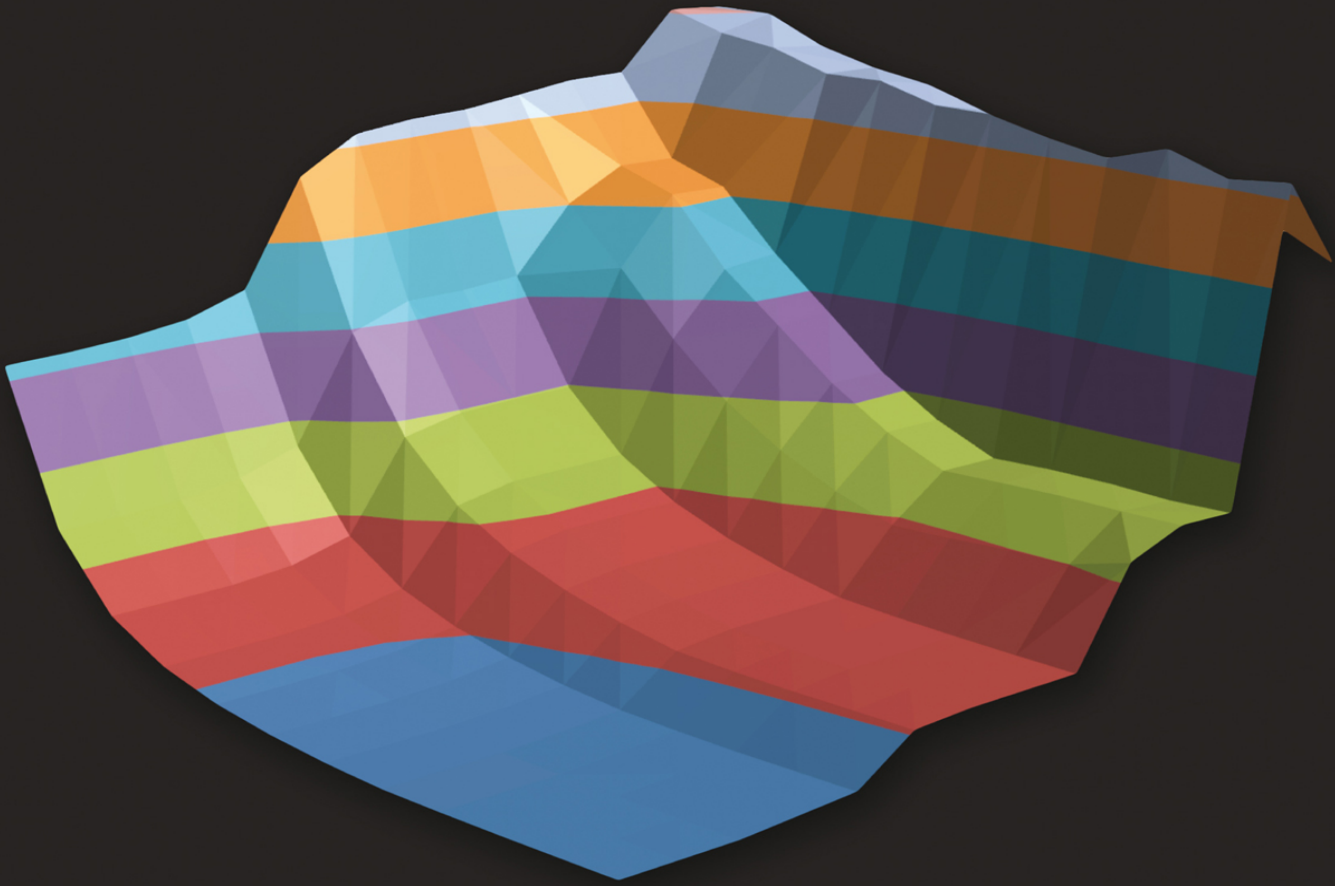


THIRD EDITION

# COMPUTER SYSTEMS

A PROGRAMMER'S PERSPECTIVE

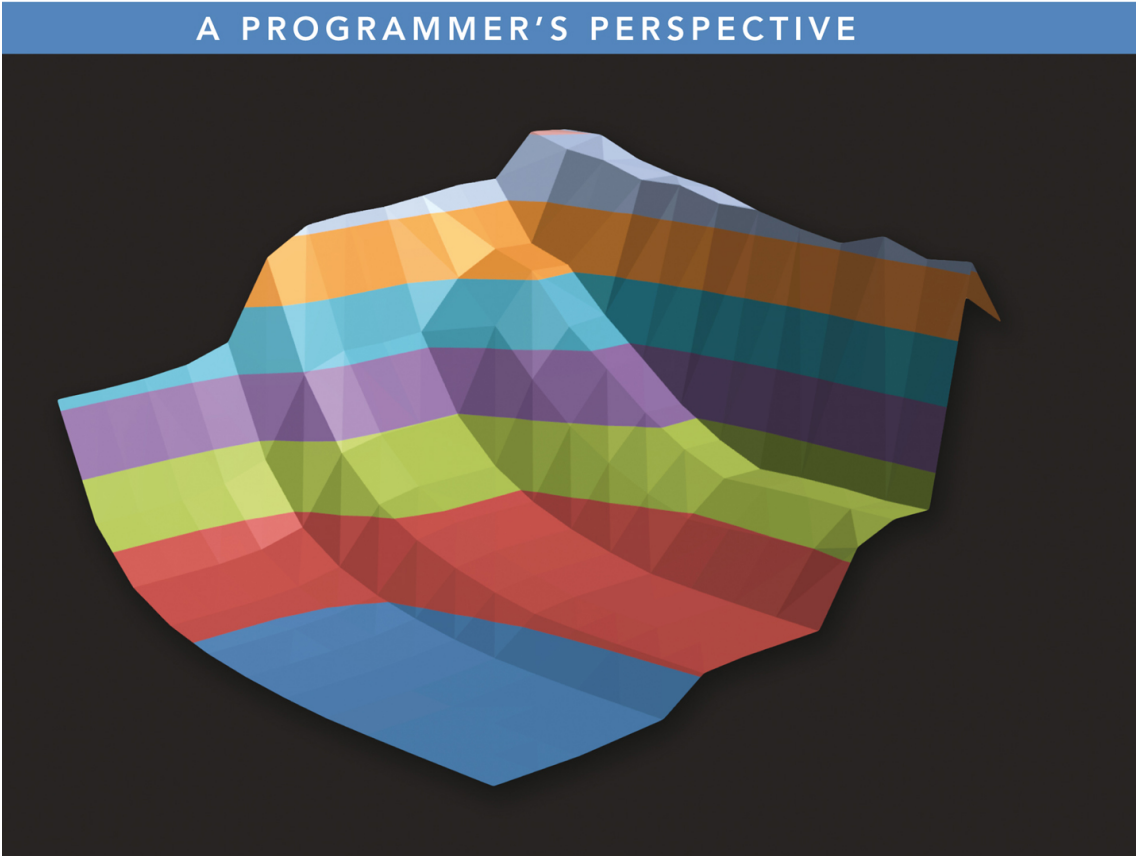


BRYANT • O'HALLARON

THIRD EDITION

# COMPUTER SYSTEMS

A PROGRAMMER'S PERSPECTIVE



BRYANT • O'HALLARON

[OceanofPDF.com](http://OceanofPDF.com)

# Computer Systems

*A Programmer's Perspective*

[OceanofPDF.com](http://OceanofPDF.com)

# Computer Systems

## *A Programmer's Perspective*

Third Edition

**Randal E. Bryant**

Carnegie Mellon University

**David R. O'Hallaron**

Carnegie Mellon University

**Pearson**

Boston Columbus Hoboken Indianapolis New York San  
Francisco Amsterdam Cape Town Dubai London Madrid  
Milan Munich Paris Montreal Toronto Delhi Mexico City  
Sao Paulo Sydney Hong Kong Seoul Singapore Taipei  
Tokyo

[OceanofPDF.com](http://OceanofPDF.com)

Vice President and Editorial Director: Marcia J. Horton

Executive Editor: Matt Goldstein

Editorial Assistant: Kelsey Loanes

VP of Marketing: Christy Lesko

Director of Field Marketing: Tim Galligan

Product Marketing Manager: Bram van Kempen

Field Marketing Manager: Demetrius Hall

Marketing Assistant: Jon Bryant

Director of Product Management: Erin Gregg

Team Lead Product Management: Scott Disanno

Program Manager: Joanne Manning

Procurement Manager: Mary Fischer

Senior Specialist, Program Planning and Support: Maura Zaldivar-Garcia

over Designer: Joyce Wells

Manager, Rights Management: Rachel Youdelman

Associate Project Manager, Rights Management: William J. Opaluch

Full-Service Project Management: Paul Anagnostopoulos, Windfall Software

Composition: Windfall Software

Printer/Binder: Courier Westford

Cover Printer: Courier Westford

Typeface: 10/12 Times 10, ITC Stone Sans

The graph on the front cover is a "memory mountain" that shows the measured read throughput of an Intel Core i7 processor as a function of spatial and temporal locality.

**Copyright © 2016, 2011, and 2003 by Randal E. Bryant and David R. O'Hallaron.** All Rights Reserved. Printed in the United States of America. This publication is protected by copyright, and permission should be obtained from the publisher prior to any prohibited reproduction, storage in a retrieval system, or transmission in any form or by any means, electronic, mechanical, photocopying, recording, or otherwise. For information regarding permissions, request forms and the appropriate contacts within the

Pearson Education Global Rights & Permissions department, please visit [www.pearsoned.com/permissions/](http://www.pearsoned.com/permissions/).

Many of the designations by manufacturers and seller to distinguish their products are claimed as trademarks. Where those designations appear in this book, and the publisher was aware of a trademark claim, the designations have been printed in initial caps or all caps.

The author and publisher of this book have used their best efforts in preparing this book. These efforts include the development, research, and testing of theories and programs to determine their effectiveness. The author and publisher make no warranty of any kind, expressed or implied, with regard to these programs or the documentation contained in this book. The author and publisher shall not be liable in any event for incidental or consequential damages with, or arising out of, the furnishing, performance, or use of these programs.

Pearson Education Ltd., *London*

Pearson Education Singapore, Pte. Ltd

Pearson Education Canada, Inc.

Pearson Education—Japan

Pearson Education Australia PTY, Limited

Pearson Education North Asia, Ltd., *Hong Kong*

Pearson Educación de México, S.A. de C.V.

Pearson Education Malaysia, Pte. Ltd.

Pearson Education, Inc., *Upper Saddle River, New Jersey*

### **Library of Congress Cataloging-in-Publication Data**

Bryant, Randal E.

Computer systems : a programmer's perspective / Randal E. Bryant, Carnegie Mellon University, David R. O'Hallaron, Carnegie Mellon University.—Third edition.

pages cm

Includes bibliographical references and index.

ISBN 978-0-13-409266-9—ISBN 0-13-409266-X

1. Computer systems. 2. Computers. 3. Telecommunication. 4. User interfaces (Computer systems) I. O'Hallaron, David R. (David Richard) II. Title.

QA76.5.B795 2016



005.3—  
dc23

2015000930

10 9 8 7 6 5 4 3 2 1



[www.pearsonhighered.com](http://www.pearsonhighered.com)

ISBN 10: 0-13-409266-X

ISBN 13: 978-0-13-409266-9

[OceanofPDF.com](http://OceanofPDF.com)

To the students and instructors of the 15–213 course at Carnegie Mellon University, for inspiring us to develop and refine the material for this book.

[OceanofPDF.com](http://OceanofPDF.com)

# MasteringEngineering<sup>®</sup>

For *Computer Systems: A Programmer's Perspective*, Third Edition

Mastering is Pearson's proven online Tutorial Homework program, newly available with the third edition of *Computer Systems: A Programmer's Perspective*. The Mastering platform allows you to integrate dynamic homework—with many problems taken directly from the Bryant/O'Hallaron textbook—with automatic grading. Mastering allows you to easily track the performance of your entire class on an assignment-by-assignment basis, or view the detailed work of an individual student.

For more information or a demonstration of the course, visit [www.MasteringEngineering.com](http://www.MasteringEngineering.com) or contact your local Pearson representative.

[OceanofPDF.com](http://OceanofPDF.com)

# Contents

Preface xix □

About the Authors xxxv □

**1 A Tour of Computer Systems 1 □**

**1.1 Information Is Bits + Context 3 □**

**1.2 Programs Are Translated by Other Programs into Different Forms 4 □**

**1.3 It Pays to Understand How Compilation Systems Work 6 □**

**1.4 Processors Read and Interpret Instructions Stored in Memory 7 □**

**1.4.1 Hardware Organization of a System 8 □**

**1.4.2 Running the `hello` Program 10 □**

**1.5 Caches Matter 11 □**

**1.6 Storage Devices Form a Hierarchy 14 □**

**1.7 The Operating System Manages the Hardware 14 □**

**1.7.1 Processes 15 □**

**1.7.2 Threads 17 □**

**1.7.3 Virtual Memory 18 □**

**1.7.4 Files 19** 

**1.8 Systems Communicate with Other Systems Using Networks 19** 

**1.9 Important Themes 22** 

**1.9.1 Amdahl's Law 22** 

**1.9.2 Concurrency and Parallelism 24** 

**1.9.3 The Importance of Abstractions in Computer Systems 26** 

**1.10 Summary 27** 

**Bibliographic Notes 28** 

**Solutions to Practice Problems 28** 

**Part I Program Structure and Execution** 

**2 Representing and Manipulating Information 31** 

**2.1 Information Storage 34** 

**2.1.1 Hexadecimal Notation 36** 

**2.1.2 Data Sizes 39** 

**2.1.3 Addressing and Byte Ordering 42** 

**2.1.4 Representing Strings 49** 

**2.1.5 Representing Code 49** 

**2.1.6 Introduction to Boolean Algebra 50** 

**2.1.7 Bit-Level Operations in C 54** 

**2.1.8 Logical Operations in C 56** 

**2.1.9 Shift Operations in C 57** 

**2.2 Integer Representations 59** 

**2.2.1 Integral Data Types 60** 

**2.2.2 Unsigned Encodings 62** 

**2.2.3 Two's-Complement Encodings 64** 

**2.2.4 Conversions between Signed and Unsigned 70** 

**2.2.5 Signed versus Unsigned in C 74** 

**2.2.6 Expanding the Bit Representation of a Number 76** 

**2.2.7 Truncating Numbers 81** 

**2.2.8 Advice on Signed versus Unsigned 83** 

**2.3 Integer Arithmetic 84** 

**2.3.1 Unsigned Addition 84** 

**2.3.2 Two's-Complement Addition 90** 

**2.3.3 Two's-Complement Negation 95** 

**2.3.4 Unsigned Multiplication 96** 

**2.3.5 Two's-Complement Multiplication 97** 

**2.3.6 Multiplying by Constants 101** 

**2.3.7 Dividing by Powers of 2 103** 

**2.3.8 Final Thoughts on Integer Arithmetic 107** 

**2.4 Floating Point 108** 

**2.4.1 Fractional Binary Numbers 109** 

**2.4.2 IEEE Floating-Point Representation 112** 

**2.4.3 Example Numbers 115** 

**2.4.4 Rounding 120** 

**2.4.5 Floating-Point Operations 122** 

**2.4.6 Floating Point in C 124** 

**2.5 Summary 126** 

**Bibliographic Notes 127** 

**Homework Problems 128** 

**Solutions to Practice Problems 143** 

**3 Machine-Level Representation of Programs 163** 



















**3.1 A Historical Perspective 166** 

**3.2 Program Encodings 169** 

**3.2.1 Machine-Level Code 170** 

**3.2.2 Code Examples 172** 

**3.2.3 Notes on Formatting 175** 

- 3.3 Data Formats 177** 
- 3.4 Accessing Information 179** 
  - 3.4.1 Operand Specifiers 180** 
  - 3.4.2 Data Movement Instructions 182** 
  - 3.4.3 Data Movement Example 186** 
  - 3.4.4 Pushing and Popping Stack Data 189** 
- 3.5 Arithmetic and Logical Operations 191** 
  - 3.5.1 Load Effective Address 191** 
  - 3.5.2 Unary and Binary Operations 194** 
  - 3.5.3 Shift Operations 194** 
  - 3.5.4 Discussion 196** 
  - 3.5.5 Special Arithmetic Operations 197** 
- 3.6 Control 200** 
  - 3.6.1 Condition Codes 201** 
  - 3.6.2 Accessing the Condition Codes 202** 
  - 3.6.3 Jump Instructions 205** 
  - 3.6.4 Jump Instruction Encodings 207** 
  - 3.6.5 Implementing Conditional Branches with Conditional Control 209** 



**3.6.6 Implementing Conditional Branches with Conditional Moves 214** 

**3.6.7 Loops 220** 

**3.6.8 Switch Statements 232** 

**3.7 Procedures 238** 

**3.7.1 The Run-Time Stack 239** 

**3.7.2 Control Transfer 241** 

**3.7.3 Data Transfer 245** 

**3.7.4 Local Storage on the Stack 248** 

**3.7.5 Local Storage in Registers 251** 

**3.7.6 Recursive Procedures 253** 

**3.8 Array Allocation and Access 255** 

**3.8.1 Basic Principles 255** 

**3.8.2 Pointer Arithmetic 257** 

**3.8.3 Nested Arrays 258** 

**3.8.4 Fixed-Size Arrays 260** 

**3.8.5 Variable-Size Arrays 262** 

**3.9 Heterogeneous Data Structures 265** 

**3.9.1 Structures 265** 

**3.9.2 Unions 269** 

**3.9.3 Data Alignment 273** 

**3.10 Combining Control and Data in Machine-Level Programs 276** 

**3.10.1 Understanding Pointers 277** 

**3.10.2 Life in the Real World: Using the GDB Debugger 279** 

**3.10.3 Out-of-Bounds Memory References and Buffer Overflow 279** 

**3.10.4 Thwarting Buffer Overflow Attacks 284** 

**3.10.5 Supporting Variable-Size Stack Frames 290** 

**3.11 Floating-Point Code 293** 

**3.11.1 Floating-Point Movement and Conversion Operations 296** 

**3.11.2 Floating-Point Code in Procedures 301** 

**3.11.3 Floating-Point Arithmetic Operations 302** 

**3.11.4 Defining and Using Floating-Point Constants 304** 

**3.11.5 Using Bitwise Operations in Floating-Point Code 305** 

**3.11.6 Floating-Point Comparison Operations 306** 

**3.11.7 Observations about Floating-Point Code 309** 

**3.12 Summary 309** 

**Bibliographic Notes 310** 

**Homework Problems 311** 

**Solutions to Practice Problems 325** 

**4 Processor Architecture 351** 

**4.1 The Y86-64 Instruction Set Architecture 355** 

**4.1.1 Programmer-Visible State 355** 

**4.1.2 Y86-64 Instructions 356** 

**4.1.3 Instruction Encoding 358** 

**4.1.4 Y86-64 Exceptions 363** 

**4.1.5 Y86-64 Programs 364** 

**4.1.6 Some Y86-64 Instruction Details 370** 




















**4.2 Logic Design and the Hardware Control Language**

**HCL 372** 

**4.2.1 Logic Gates 373** 

**4.2.2 Combinational Circuits and HCL Boolean Expressions 374** 

**4.2.3 Word-Level Combinational Circuits and HCL Integer Expressions 376** 

- 4.2.4 Set Membership 380 
- 4.2.5 Memory and Clocking 381 
- 4.3 Sequential Y86-64 Implementations 384 
  - 4.3.1 Organizing Processing into Stages 384 
  - 4.3.2 SEQ Hardware Structure 396 
  - 4.3.3 SEQ Timing 400 
  - 4.3.4 SEQ Stage Implementations 404 
- 4.4 General Principles of Pipelining 412 
  - 4.4.1 Computational Pipelines 412 
  - 4.4.2 A Detailed Look at Pipeline Operation 414 
  - 4.4.3 Limitations of Pipelining 416 
  - 4.4.4 Pipelining a System with Feedback 419 
- 4.5 Pipelined Y86-64 Implementations 421 
  - 4.5.1 SEQ+: Rearranging the Computation Stages 421 
  - 4.5.2 Inserting Pipeline Registers 422 
  - 4.5.3 Rearranging and Relabeling Signals 426 
  - 4.5.4 Next PC Prediction 427 
  - 4.5.5 Pipeline Hazards 429 
  - 4.5.6 Exception Handling 444 

**4.5.7 PIPE Stage Implementations 447** 

**4.5.8 Pipeline Control Logic 455** 

**4.5.9 Performance Analysis 464** 

**4.5.10 Unfinished Business 468** 

**4.6 Summary 470** 


**4.6.1 Y86-64 Simulators 472** 

**Bibliographic Notes 473** 

**Homework Problems 473** 

**Solutions to Practice Problems 480** 

**5 Optimizing Program Performance 495** 

**5.1 Capabilities and Limitations of Optimizing Compilers  
498** 

**5.2 Expressing Program Performance 502** 

**5.3 Program Example 504** 

**5.4 Eliminating Loop Inefficiencies 508** 

**5.5 Reducing Procedure Calls 512** 

**5.6 Eliminating Unneeded Memory References 514** 

**5.7 Understanding Modern Processors 517** 

**5.7.1 Overall Operation 518** 

**5.7.2 Functional Unit Performance 523** 

**5.7.3 An Abstract Model of Processor Operation 525** 

**5.8 Loop Unrolling 531** 

**5.9 Enhancing Parallelism 536** 

**5.9.1 Multiple Accumulators 536** 

**5.9.2 Reassociation Transformation 541** 

**5.10 Summary of Results for Optimizing Combining Code 547** 

**5.11 Some Limiting Factors 548** 

**5.11.1 Register Spilling 548** 

**5.11.2 Branch Prediction and Misprediction Penalties 549** 

**5.12 Understanding Memory Performance 553** 

**5.12.1 Load Performance 554** 

**5.12.2 Store Performance 555** 

**5.13 Life in the Real World: Performance Improvement Techniques 561** 

**5.14 Identifying and Eliminating Performance Bottlenecks 562** 

**5.14.1 Program Profiling 562** 

**5.14.2 Using a Profiler to Guide Optimization 565** 

**5.15 Summary 568** 

**Bibliographic Notes 569** 

**Homework Problems 570** 

**Solutions to Practice Problems 573** 

**6 The Memory Hierarchy 579** 

**6.1 Storage Technologies 581** 

**6.1.1 Random Access Memory 581** 

**6.1.2 Disk Storage 589** 

**6.1.3 Solid State Disks 600** 

**6.1.4 Storage Technology Trends 602** 

**6.2 Locality 604** 

**6.2.1 Locality of References to Program Data 606** 

**6.2.2 Locality of Instruction Fetches 607** 

**6.2.3 Summary of Locality 608** 

**6.3 The Memory Hierarchy 609** 

**6.3.1 Caching in the Memory Hierarchy 610** 

**6.3.2 Summary of Memory Hierarchy Concepts 614** 

**6.4 Cache Memories 614** 

**6.4.1 Generic Cache Memory Organization 615** 

**6.4.2 Direct-Mapped Caches 617** 

**6.4.3 Set Associative Caches 624** 

**6.4.4 Fully Associative Caches 626** 

**6.4.5 Issues with Writes 630** 

**6.4.6 Anatomy of a Real Cache Hierarchy 631** 

[OceanofPDF.com](http://OceanofPDF.com)



**6.4.7 Performance Impact of Cache Parameters 631** 

**6.5 Writing Cache-Friendly Code 633** 

**6.6 Putting It Together: The Impact of Caches on Program Performance 639** 

**6.6.1 The Memory Mountain 639** 

**6.6.2 Rearranging Loops to Increase Spatial Locality 643** 

**6.6.3 Exploiting Locality in Your Programs 647** 

**6.7 Summary 648** 

**Bibliographic Notes 648** 

**Homework Problems 649** 

**Solutions to Practice Problems 660** 

**Part II Running Programs on a System** 

**7 Linking 669** 

**7.1 Compiler Drivers 671** 

**7.2 Static Linking 672** 

**7.3 Object Files 673** 

**7.4 Relocatable Object Files 674** 

**7.5 Symbols and Symbol Tables 675** 

**7.6 Symbol Resolution 679** 

**7.6.1 How Linkers Resolve Duplicate Symbol Names 680** 

**7.6.2 Linking with Static Libraries 684** 

**7.6.3 How Linkers Use Static Libraries to Resolve References 688** 

**7.7 Relocation 689** 

**7.7.1 Relocation Entries 690** 

**7.7.2 Relocating Symbol References 691** 

**7.8 Executable Object Files 695** 

**7.9 Loading Executable Object Files 697** 

**7.10 Dynamic Linking with Shared Libraries 698** 

**7.11 Loading and Linking Shared Libraries from Applications 701** 

**7.12 Position-Independent Code (PIC) 704** 

**7.13 Library Interpositioning 707** 

**7.13.1 Compile-Time Interpositioning 708** 

**7.13.2 Link-Time Interpositioning 708** 

**7.13.3 Run-Time Interpositioning 710** 

**7.14 Tools for Manipulating Object Files 713** 

**7.15 Summary 713** 

[Bibliographic Notes 714](#) 

[Homework Problems 714](#) 

[Solutions to Practice Problems 717](#) 

**8 Exceptional Control Flow 721** 

**8.1 Exceptions 723** 

**8.1.1 Exception Handling 724** 

**8.1.2 Classes of Exceptions 726** 

**8.1.3 Exceptions in Linux/x86-64 Systems 729** 

**8.2 Processes 732** 

**8.2.1 Logical Control Flow 732** 

**8.2.2 Concurrent Flows 733** 

**8.2.3 Private Address Space 734** 

**8.2.4 User and Kernel Modes 734** 

**8.2.5 Context Switches 736** 

**8.3 System Call Error Handling 737** 

**8.4 Process Control 738** 

**8.4.1 Obtaining Process IDs 739** 

**8.4.2 Creating and Terminating Processes 739** 

**8.4.3 Reaping Child Processes 743** 

**8.4.4 Putting Processes to Sleep 749** 

**8.4.5 Loading and Running Programs 750** 

**8.4.6 Using `fork` and `execve` to Run Programs 753** 

**8.5 Signals 756** 

**8.5.1 Signal Terminology 758** 

**8.5.2 Sending Signals 759** 

**8.5.3 Receiving Signals 762** 

**8.5.4 Blocking and Unblocking Signals 764** 

**8.5.5 Writing Signal Handlers 766** 

**8.5.6 Synchronizing Flows to Avoid Nasty Concurrency Bugs 776** 

**8.5.7 Explicitly Waiting for Signals 778** 

**8.6 Nonlocal Jumps 781** 

**8.7 Tools for Manipulating Processes 786** 

**8.8 Summary 787** 

**Bibliographic Notes 787** 

**Homework Problems 788** 

**Solutions to Practice Problems 795** 

**9 Virtual Memory 801** 

**9.1 Physical and Virtual Addressing 803** 

**9.2 Address Spaces 804** 

**9.3 VM as a Tool for Caching 805** 

**9.3.1 DRAM Cache Organization 806** 

**9.3.2 Page Tables 806** 

**9.3.3 Page Hits 808** 

**9.3.4 Page Faults 808** 

**9.3.5 Allocating Pages 810** 

**9.3.6 Locality to the Rescue Again 810** 

**9.4 VM as a Tool for Memory Management 811** 


**9.5 VM as a Tool for Memory Protection 812** 

**9.6 Address Translation 813** 

**9.6.1 Integrating Caches and VM 817** 

**9.6.2 Speeding Up Address Translation with a TLB 817** 

**9.6.3 Multi-Level Page Tables 819** 

**9.6.4 Putting It Together: End-to-End Address Translation 821** 

**9.7 Case Study: The Intel Core i7/Linux Memory System 825** 

**9.7.1 Core i7 Address Translation 826** 

**9.7.2 Linux Virtual Memory System 828** 

## 9.8 Memory Mapping 833

### 9.8.1 Shared Objects Revisited 833

### 9.8.2 The `fork` Function Revisited 836

### 9.8.3 The `execve` Function Revisited 836

### 9.8.4 User-Level Memory Mapping with the `mmap` Function 837

## 9.9 Dynamic Memory Allocation 839

### 9.9.1 The `malloc` and `free` Functions 840

### 9.9.2 Why Dynamic Memory Allocation? 843

### 9.9.3 Allocator Requirements and Goals 844

### 9.9.4 Fragmentation 846

### 9.9.5 Implementation Issues 846

### 9.9.6 Implicit Free Lists 847

### 9.9.7 Placing Allocated Blocks 849

### 9.9.8 Splitting Free Blocks 849

### 9.9.9 Getting Additional Heap Memory 850

### 9.9.10 Coalescing Free Blocks 850

### 9.9.11 Coalescing with Boundary Tags 851

### 9.9.12 Putting It Together: Implementing a Simple Allocator 854

**9.9.13 Explicit Free Lists 862** 

**9.9.14 Segregated Free Lists 863** 

**9.10 Garbage Collection 865** 

**9.10.1 Garbage Collector Basics 866** 

**9.10.2 Mark&Sweep Garbage Collectors 867** 

**9.10.3 Conservative Mark&Sweep for C Programs 869** 

**9.11 Common Memory-Related Bugs in C Programs 870** 

**9.11.1 Dereferencing Bad Pointers 870** 

**9.11.2 Reading Uninitialized Memory 871** 

**9.11.3 Allowing Stack Buffer Overflows 871** 

**9.11.4 Assuming That Pointers and the Objects They Point to Are the Same Size 872** 

**9.11.5 Making Off-by-One Errors 872** 

**9.11.6 Referencing a Pointer Instead of the Object It Points To 873** 

**9.11.7 Misunderstanding Pointer Arithmetic 873** 

**9.11.8 Referencing Nonexistent Variables 874** 

**9.11.9 Referencing Data in Free Heap Blocks 874** 

**9.11.10 Introducing Memory Leaks 875** 

**9.12 Summary 875** 

[Bibliographic Notes 876](#) 

[Homework Problems 876](#) 

[Solutions to Practice Problems 880](#) 

## [Part III Interaction and Communication between Programs](#)

### [10 System-Level I/O 889](#)

[10.1 Unix I/O 890](#) 

[10.2 Files 891](#) 

[10.3 Opening and Closing Files 893](#) 

[10.4 Reading and Writing Files 895](#) 

[10.5 Robust Reading and Writing with the RIo Package 897](#) 

[10.5.1 RIo Unbuffered Input and Output Functions 897](#) 

[10.5.2 RIo Buffered Input Functions 898](#) 

[10.6 Reading File Metadata 903](#) 

[10.7 Reading Directory Contents 905](#) 

[10.8 Sharing Files 906](#) 

[10.9 I/O Redirection 909](#) 

[10.10 Standard I/O 911](#) 

[10.11 Putting It Together: Which I/O Functions Should I Use? 911](#) 

[10.12 Summary 913](#) 



**Bibliographic Notes 914** 

**Homework Problems 914** 

**Solutions to Practice Problems 915** 

**11 Network Programming 917** 

**11.1 The Client-Server Programming Model 918** 

**11.2 Networks 919** 

**11.3 The Global IP Internet 924** 

**11.3.1 IP Addresses 925** 

**11.3.2 Internet Domain Names 927** 

**11.3.3 Internet Connections 929** 

**11.4 The Sockets Interface 932** 

**11.4.1 Socket Address Structures 933** 

**11.4.2 The `socket` Function 934** 

**11.4.3 The `connect` Function 934** 

**11.4.4 The `bind` Function 935** 

**11.4.5 The `listen` Function 935** 

**11.4.6 The `accept` Function 936** 

**11.4.7 Host and Service Conversion 937** 

**11.4.8 Helper Functions for the Sockets Interface 942** 

**11.4.9 Example Echo Client and Server 944** 

**11.5 Web Servers 948** 

**11.5.1 Web Basics 948** 

**11.5.2 Web Content 949** 

**11.5.3 HTTP Transactions 950** 

**11.5.4 Serving Dynamic Content 953** 

**11.6 Putting It Together: The TINY Web Server 956** 

**11.7 Summary 964** 

**Bibliographic Notes 965** 

**Homework Problems 965** 

**Solutions to Practice Problems 966** 

**12 Concurrent Programming 971** 

**12.1 Concurrent Programming with Processes 973** 

**12.1.1 A Concurrent Server Based on Processes 974** 

**12.1.2 Pros and Cons of Processes 975** 

**12.2 Concurrent Programming with I/O Multiplexing 977** 

**12.2.1 A Concurrent Event-Driven Server Based on I/O Multiplexing 980** 

**12.2.2 Pros and Cons of I/O Multiplexing 985** 

- 12.3 Concurrent Programming with Threads 985** 
- 12.3.1 Thread Execution Model 986** 
- 12.3.2 Posix Threads 987** 
- 12.3.3 Creating Threads 988** 
- 12.3.4 Terminating Threads 988** 
- 12.3.5 Reaping Terminated Threads 989** 
- 12.3.6 Detaching Threads 989** 
- 12.3.7 Initializing Threads 990** 
- 12.3.8 A Concurrent Server Based on Threads 991** 
  
- 12.4 Shared Variables in Threaded Programs 992** 
- 12.4.1 Threads Memory Model 993** 
- 12.4.2 Mapping Variables to Memory 994** 
- 12.4.3 Shared Variables 995** 
  
- 12.5 Synchronizing Threads with Semaphores 995** 
- 12.5.1 Progress Graphs 999** 
- 12.5.2 Semaphores 1001** 
- 12.5.3 Using Semaphores for Mutual Exclusion 1002** 
- 12.5.4 Using Semaphores to Schedule Shared Resources 1004** 

**12.5.5 Putting It Together: A Concurrent Server Based on Prethreading 1008** 

**12.6 Using Threads for Parallelism 1013** 

**12.7 Other Concurrency Issues 1020** 

**12.7.1 Thread Safety 1020** 

**12.7.2 Reentrancy 1023** 

**12.7.3 Using Existing Library Functions in Threaded Programs 1024** 

**12.7.4 Races 1025** 

**12.7.5 Deadlocks 1027** 

**12.8 Summary 1030** 

**Bibliographic Notes 1030** 

**Homework Problems 1031** 

**Solutions to Practice Problems 1036** 

**A Error Handling 1041** 

**A.1 Error Handling in Unix Systems 1042** 

**A.2 Error-Handling Wrappers 1043** 

**References 1047** 

**Index 1053** 

[OceanofPDF.com](http://OceanofPDF.com)

# Preface

This book (known as CS:APP) is for computer scientists, computer engineers, and others who want to be able to write better programs by learning what is going on "under the hood" of a computer system.

Our aim is to explain the enduring concepts underlying all computer systems, and to show you the concrete ways that these ideas affect the correctness, performance, and utility of your application programs. Many systems books are written from a *builder's perspective*, describing how to implement the hardware or the systems software, including the operating system, compiler, and network interface. This book is written from a *programmer's perspective*, describing how application programmers can use their knowledge of a system to write better programs. Of course, learning what a system is supposed to do provides a good first step in learning how to build one, so this book also serves as a valuable introduction to those who go on to implement systems hardware and software. Most systems books also tend to focus on just one aspect of the system, for example, the hardware architecture, the operating system, the compiler, or the network. This book spans all of these aspects, with the unifying theme of a programmer's perspective.

If you study and learn the concepts in this book, you will be on your way to becoming the rare *power programmer* who knows how things work and how to fix them when they break. You will be able to write

programs that make better use of the capabilities provided by the operating system and systems software, that operate correctly across a wide range of operating conditions and run-time parameters, that run faster, and that avoid the flaws that make programs vulnerable to cyberattack. You will be prepared to delve deeper into advanced topics such as compilers, computer architecture, operating systems, embedded systems, networking, and cybersecurity.

# Assumptions about the Reader's Background

This book focuses on systems that execute x86-64 machine code. x86-64 is the latest in an evolutionary path followed by Intel and its competitors that started with the 8086 microprocessor in 1978. Due to the naming conventions used by Intel for its microprocessor line, this class of microprocessors is referred to colloquially as "x86." As semiconductor technology has evolved to allow more transistors to be integrated onto a single chip, these processors have progressed greatly in their computing power and their memory capacity. As part of this progression, they have gone from operating on 16-bit words, to 32-bit words with the introduction of IA32 processors, and most recently to 64-bit words with x86-64.

We consider how these machines execute C programs on Linux. Linux is one of a number of operating systems having their heritage in the Unix operating system developed originally by Bell Laboratories. Other members of this class



# New to C? Advice on the C programming language

To help readers whose background in C programming is weak (or nonexistent), we have also included these special notes to highlight features that are especially important in C. We assume you are familiar with C++ or Java.

of operating systems include Solaris, FreeBSD, and MacOS X. In recent years, these operating systems have maintained a high level of compatibility through the efforts of the Posix and Standard Unix Specification standardization efforts. Thus, the material in this book applies almost directly to these "Unix-like" operating systems.

The text contains numerous programming examples that have been compiled and run on Linux systems. We assume that you have access to such a machine, and are able to log in and do simple things such as listing files and changing directories. If your computer runs Microsoft Windows, we recommend that you install one of the many different virtual machine environments (such as VirtualBox or VMWare) that allow programs written for one operating system (the guest OS) to run under another (the host OS).

We also assume that you have some familiarity with C or C++. If your only prior experience is with Java, the transition will require more effort on your part, but we will help you. Java and C share similar syntax and control statements. However, there are aspects of C (particularly pointers, explicit dynamic memory allocation, and

formatted I/O) that do not exist in Java. Fortunately, C is a small language, and it is clearly and beautifully described in the classic "K&R" text by Brian Kernighan and Dennis Ritchie [61]. Regardless of your programming background, consider K&R an essential part of your personal systems library. If your prior experience is with an interpreted language, such as Python, Ruby, or Perl, you will definitely want to devote some time to learning C before you attempt to use this book.

Several of the early chapters in the book explore the interactions between C programs and their machine-language counterparts. The machine-language examples were all generated by the GNU `gcc` compiler running on x86-64 processors. We do not assume any prior experience with hardware, machine language, or assembly-language programming.

# How to Read the Book

Learning how computer systems work from a programmer's perspective is great fun, mainly because you can do it actively. Whenever you learn something new, you can try it out right away and see the result firsthand. In fact, we believe that the only way to learn systems is to *do* systems, either working concrete problems or writing and running programs on real systems.

This theme pervades the entire book. When a new concept is introduced, it is followed in the text by one or more *practice problems* that you should work

-----code/intro/hello.c

```
|  
1 #include <stdio.h>  
2  
3 int main()  
4 {  
5     printf("hello, world\n");  
6     return 0;  
7 }
```

-----code/intro/hello.c

**Figure 1 A typical code example.**


immediately to test your understanding. Solutions to the practice problems are at the end of each chapter. As you read, try to solve each problem on your own and then check the solution to make sure you are on the right track. Each chapter is followed by a set of *homework problems* of varying difficulty. Your instructor has the solutions to the homework problems in an instructor's manual. For each homework problem, we show a rating of the amount of effort we feel it will require:

- ◆ Should require just a few minutes. Little or no programming required.

◆◆ Might require up to 20 minutes. Often involves writing and testing some code. (Many of these are derived from problems we have given on exams.)

◆◆◆ Requires a significant effort, perhaps 1–2 hours. Generally involves writing and testing a significant amount of code.

◆◆◆◆ A lab assignment, requiring up to 10 hours of effort.

Each code example in the text was formatted directly, without any manual intervention, from a C program compiled with `gcc` and tested on a Linux system. Of course, your system may have a different version of `gcc`, or a different compiler altogether, so your compiler might generate different machine code; but the overall behavior should be the same. All of the source code is available from the CS:APP Web page ("CS:APP" being our shorthand for the book's title) at [csapp.cs.cmu.edu](http://csapp.cs.cmu.edu). In the text, the filenames of the source programs are documented in horizontal bars that surround the formatted code. For example, the program in [Figure 1](#)  can be found in the file `hello.c` in directory `code/intro/`. We encourage you to try running the example programs on your system as you encounter them.


To avoid having a book that is overwhelming, both in bulk and in content, we have created a number of *Web asides* containing material that supplements the main presentation of the book. These asides are referenced within the book with a notation of the form `CHAP:TOP`, where `CHAP` is a short encoding of the chapter subject, and `TOP` is a short code for the topic that is covered. For example, `Web`


Aside `DATA:BOOL` contains supplementary material on Boolean algebra for the presentation on data representations in [Chapter 2](#), while Web Aside `ARCH:VLOG` contains material describing processor designs using the Verilog hardware description language, supplementing the presentation of processor design in [Chapter 4](#). All of these Web asides are available from the CS:APP Web page.

[OceanofPDF.com](http://OceanofPDF.com)


# Book Overview

The CS:APP book consists of 12 chapters designed to capture the core ideas in computer systems. Here is an overview.

**Chapter 1** : **A Tour of Computer Systems.** This chapter introduces the major ideas and themes in computer systems by tracing the life cycle of a simple "hello, world" program.

**Chapter 2** : **Representing and Manipulating Information.** We cover computer arithmetic, emphasizing the properties of unsigned and two's-complement number representations that affect programmers. We consider how numbers are represented and therefore what range of values can be encoded for a given word size. We consider the effect of casting between signed and unsigned numbers. We cover the mathematical properties of arithmetic operations. Novice programmers are often surprised to learn that the (two's-complement) sum or product of two positive numbers can be negative. On the other hand, two's-complement arithmetic satisfies many of the algebraic properties of integer arithmetic, and hence a compiler can safely transform multiplication by a constant into a sequence of shifts and adds. We use the bit-level operations of C to demonstrate the principles and applications of Boolean algebra. We cover the IEEE floating-point format in terms of how it represents values and the mathematical properties of floating-point operations.

Having a solid understanding of computer arithmetic is critical to writing reliable programs. For example, programmers and compilers cannot replace the expression  $(x < y)$  with  $(x - y < 0)$ , due to the possibility of overflow. They cannot even replace it with the expression  $(-y < -x)$ , due to the asymmetric range of negative and positive numbers in the two's-complement representation. Arithmetic overflow is a common source of programming errors and security vulnerabilities, yet few other books cover the properties of computer arithmetic from a programmer's perspective.


**Chapter 3** : **Machine-Level Representation of Programs.** We teach you how to read the x86-64 machine code generated by a C compiler. We cover the basic instruction patterns generated for different control constructs, such as conditionals, loops, and switch statements. We cover the implementation of procedures, including stack allocation, register usage conventions, and parameter passing. We cover the way different data structures such as structures, unions, and arrays are allocated and accessed. We cover the instructions that implement both integer and floating-point arithmetic. We also use the machine-level view of programs as a way to understand common code security vulnerabilities, such as buffer overflow, and steps that the programmer,




## Aside What is an aside?


You will encounter asides of this form throughout the text. Asides are parenthetical remarks that give you some additional insight into the current topic. Asides serve a number of purposes. Some are little history lessons. For example, where did C, Linux, and the Internet come from? Other asides are meant to clarify ideas that students often find confusing. For example, what is the difference between a cache line, set, and block? Other asides give real-world examples, such as how a floating-point error crashed a French rocket or the geometric and operational parameters of a commercial disk drive. Finally, some asides are just fun stuff. For example, what is a "hoinky"?

grammer, the compiler, and the operating system can take to reduce these threats. Learning the concepts in this chapter helps you become a better programmer, because you will understand how programs are represented on a machine. One certain benefit is that you will develop a thorough and concrete understanding of pointers.


**Chapter 4** : **Processor Architecture.** This chapter covers basic combinational and sequential logic elements, and then shows how these elements can be combined in a datapath that executes a simplified subset of the x86-64 instruction set called "Y86-64." We begin with the design of a single-cycle datapath. This design is conceptually very simple, but it would not be very fast. We then introduce *pipelining*, where the different steps


required to process an instruction are implemented as separate stages. At any given time, each stage can work on a different instruction. Our five-stage processor pipeline is much more realistic. The control logic for the processor designs is described using a simple hardware description language called HCL. Hardware designs written in HCL can be compiled and linked into simulators provided with the textbook, and they can be used to generate Verilog descriptions suitable for synthesis into working hardware.

**Chapter 5** : **Optimizing Program Performance.** This chapter introduces a number of techniques for improving code performance, with the idea being that programmers learn to write their C code in such a way that a compiler can then generate efficient machine code. We start with transformations that reduce the work to be done by a program and hence should be standard practice when writing any program for any machine. We then progress to transformations that enhance the degree of instruction-level parallelism in the generated machine code, thereby improving their performance on modern "superscalar" processors. To motivate these transformations, we introduce a simple operational model of how modern out-of-order processors work, and show how to measure the potential performance of a program in terms of the critical paths through a graphical representation of a program. You will be surprised how much you can speed up a program by simple transformations of the C code.

**Chapter 6** : **The Memory Hierarchy.** The memory system is one of the most visible parts of a computer system to application


programmers. To this point, you have relied on a conceptual model of the memory system as a linear array with uniform access times. In practice, a memory system is a hierarchy of storage devices with different capacities, costs, and access times. We cover the different types of RAM and ROM memories and the geometry and organization of magnetic-disk and solid state drives. We describe how these storage devices are arranged in a hierarchy. We show how this hierarchy is made possible by locality of reference. We make these ideas concrete by introducing a unique view of a memory system as a "memory mountain" with ridges of temporal locality and slopes of spatial locality. Finally, we show you how to improve the performance of application programs by improving their temporal and spatial locality.

**Chapter 7** : **Linking.** This chapter covers both static and dynamic linking, including the ideas of relocatable and executable object files, symbol resolution, relocation, static libraries, shared object libraries, position-independent code, and library interpositioning. Linking is not covered in most systems texts, but we cover it for two reasons. First, some of the most confusing errors that programmers can encounter are related to glitches during linking, especially for large software packages. Second, the object files produced by linkers are tied to concepts such as loading, virtual memory, and memory mapping.


**Chapter 8** : **Exceptional Control Flow.** In this part of the presentation, we step beyond the single-program model by introducing the general concept of exceptional control flow (i.e.,


changes in control flow that are outside the normal branches and procedure calls). We cover examples of exceptional control flow that exist at all levels of the system, from low-level hardware exceptions and interrupts, to context switches between concurrent processes, to abrupt changes in control flow caused by the receipt of Linux signals, to the nonlocal jumps in C that break the stack discipline.

This is the part of the book where we introduce the fundamental idea of a *process*, an abstraction of an executing program. You will learn how processes work and how they can be created and manipulated from application programs. We show how application programmers can make use of multiple processes via Linux system calls. When you finish this chapter, you will be able to write a simple Linux shell with job control. It is also your first introduction to the nondeterministic behavior that arises with concurrent program execution.


**Chapter 9** : **Virtual Memory.** Our presentation of the virtual memory system seeks to give some understanding of how it works and its characteristics. We want you to know how it is that the different simultaneous processes can each use an identical range of addresses, sharing some pages but having individual copies of others. We also cover issues involved in managing and manipulating virtual memory. In particular, we cover the operation of storage allocators such as the standard-library `malloc` and `free` operations. Covering this material serves several purposes. It reinforces the concept that the virtual memory space is just an array of bytes that the program can subdivide into different

storage units. It helps you understand the effects of programs containing memory referencing errors such as storage leaks and invalid pointer references. Finally, many application programmers write their own storage allocators optimized toward the needs and characteristics of the application. This chapter, more than any other, demonstrates the benefit of covering both the hardware and the software aspects of computer systems in a unified way. Traditional computer architecture and operating systems texts present only part of the virtual memory story.

**Chapter 10** : **System-Level I/O.** We cover the basic concepts of Unix I/O such as files and descriptors. We describe how files are shared, how I/O redirection works, and how to access file metadata. We also develop a robust buffered I/O package that deals correctly with a curious behavior known as *short counts*, where the library function reads only part of the input data. We cover the C standard I/O library and its relationship to Linux I/O, focusing on limitations of standard I/O that make it unsuitable for network programming. In general, the topics covered in this chapter are building blocks for the next two chapters on network and concurrent programming.

**Chapter 11** : **Network Programming.** Networks are interesting I/O devices to program, tying together many of the ideas that we study earlier in the text, such as processes, signals, byte ordering, memory mapping, and dynamic storage allocation. Network programs also provide a compelling context for concurrency, which is the topic of the next chapter. This chapter is a thin slice through network programming that gets you to the



point where you can write a simple Web server. We cover the client-server model that underlies all network applications. We present a programmer's view of the Internet and show how to write Internet clients and servers using the sockets interface. Finally, we introduce HTTP and develop a simple iterative Web server.


**Chapter 12** : **Concurrent Programming.** This chapter introduces concurrent programming using Internet server design as the running motivational example. We compare and contrast the three basic mechanisms for writing concurrent programs—processes, I/O multiplexing, and threads—and show how to use them to build concurrent Internet servers. We cover basic principles of synchronization using *P* and *V* semaphore operations, thread safety and reentrancy, race conditions, and deadlocks. Writing concurrent code is essential for most server applications. We also describe the use of thread-level programming to express parallelism in an application program, enabling faster execution on multi-core processors. Getting all of the cores working on a single computational problem requires a careful coordination of the concurrent threads, both for correctness and to achieve high performance.

# New to This Edition


The first edition of this book was published with a copyright of 2003, while the second had a copyright of 2011. Considering the rapid evolution of computer technology, the book content has held up surprisingly well. Intel x86 machines running C programs under Linux (and related operating systems) has proved to be a combination that continues to encompass many systems today. However, changes in hardware technology, compilers, program library interfaces, and the experience of many instructors teaching the material have prompted a substantial revision.


The biggest overall change from the second edition is that we have switched our presentation from one based on a mix of IA32 and x86-64 to one based exclusively on x86-64. This shift in focus affected the contents of many of the chapters. Here is a summary of the significant changes.


**Chapter 1** : **A Tour of Computer Systems** We have moved the discussion of Amdahl's Law from **Chapter 5**  into this chapter.


**Chapter 2** : **Representing and Manipulating Information.** A consistent bit of feedback from readers and reviewers is that some of the material in this chapter can be a bit overwhelming. So we have tried to make the material more accessible by clarifying the points at which we delve into a more mathematical style of presentation. This enables readers to first skim over


mathematical details to get a high-level overview and then return for a more thorough reading.

**Chapter 3** : **Machine-Level Representation of Programs.** We have converted from the earlier presentation based on a mix of IA32 and x86-64 to one based entirely on x86-64. We have also updated for the style of code generated by more recent versions of gcc. The result is a substantial rewriting, including changing the order in which some of the concepts are presented. We also have included, for the first time, a presentation of the machine-level support for programs operating on floating-point data. We have created a Web aside describing IA32 machine code for legacy reasons.

**Chapter 4** : **Processor Architecture.** We have revised the earlier processor design, based on a 32-bit architecture, to one that supports 64-bit words and operations.


**Chapter 5** : **Optimizing Program Performance.** We have updated the material to reflect the performance capabilities of recent generations of x86-64 processors. With the introduction of more functional units and more sophisticated control logic, the model of program performance we developed based on a data-flow representation of programs has become a more reliable predictor of performance than it was before.


**Chapter 6** : **The Memory Hierarchy.** We have updated the material to reflect more recent technology.


**Chapter 7** : **Linking.** We have rewritten this chapter for x86-64, expanded the discussion of using the GOT and PLT to create





position-independent code, and added a new section on a powerful linking technique known as *library interpositioning*.

**Chapter 8** : **Exceptional Control Flow.** We have added a more rigorous treatment of signal handlers, including async-signal-safe functions, specific guidelines for writing signal handlers, and using `sigsuspend` to wait for handlers.

**Chapter 9** : **Virtual Memory.** This chapter has changed only slightly.

**Chapter 10** : **System-Level I/O.** We have added a new section on files and the file hierarchy, but otherwise, this chapter has changed only slightly.

**Chapter 11** : **Network Programming.** We have introduced techniques for protocol-independent and thread-safe network programming using the modern `getaddrinfo` and `getnameinfo` functions, which replace the obsolete and non-reentrant `gethostbyname` and `gethostbyaddr` functions.

**Chapter 12** : **Concurrent Programming.** We have increased our coverage of using thread-level parallelism to make programs run faster on multi-core machines.

In addition, we have added and revised a number of practice and homework problems throughout the text.

# Origins of the Book

This book stems from an introductory course that we developed at Carnegie Mellon University in the fall of 1998, called 15–213: Introduction to Computer Systems (ICS) [14]. The ICS course has been taught every semester since then. Over 400 students take the course each semester. The students range from sophomores to graduate students in a wide variety of majors. It is a required core course for all undergraduates in the CS and ECE departments at Carnegie Mellon, and it has become a prerequisite for most upper-level systems courses in CS and ECE.

The idea with ICS was to introduce students to computers in a different way. Few of our students would have the opportunity to build a computer system. On the other hand, most students, including all computer scientists and computer engineers, would be required to use and program computers on a daily basis. So we decided to teach about systems from the point of view of the programmer, using the following filter: we would cover a topic only if it affected the performance, correctness, or utility of user-level C programs.

For example, topics such as hardware adder and bus designs were out. Topics such as machine language were in; but instead of focusing on how to write assembly language by hand, we would look at how a C compiler translates C constructs into machine code, including pointers, loops, procedure calls, and switch statements.

Further, we would take a broader and more holistic view of the system as both hardware and systems software, covering such topics as linking, loading, processes, signals, performance optimization, virtual memory, I/O, and network and concurrent programming.

This approach allowed us to teach the ICS course in a way that is practical, concrete, hands-on, and exciting for the students. The response from our students and faculty colleagues was immediate and overwhelmingly positive, and we realized that others outside of CMU might benefit from using our approach. Hence this book, which we developed from the ICS lecture notes, and which we have now revised to reflect changes in technology and in how computer systems are implemented.

Via the multiple editions and multiple translations of this book, ICS and many variants have become part of the computer science and computer engineering curricula at hundreds of colleges and universities worldwide.

# For Instructors: Courses Based on the Book

Instructors can use the CS:APP book to teach a number of different types of systems courses. Five categories of these courses are illustrated in [Figure 2](#). The particular course depends on curriculum requirements, personal taste, and the backgrounds and abilities of the students. From left to right in the figure, the courses are characterized by an increasing emphasis on the programmer's perspective of a system. Here is a brief description.

**ORG.** A computer organization course with traditional topics covered in an un-traditional style. Traditional topics such as logic design, processor architecture, assembly language, and memory systems are covered. However, there is more emphasis on the impact for the programmer. For example, data representations are related back to the data types and operations of C programs, and the presentation on assembly code is based on machine code generated by a C compiler rather than handwritten assembly code.

**ORG+.** The ORG course with additional emphasis on the impact of hardware on the performance of application programs. Compared to ORG, students learn more about code optimization and about improving the memory performance of their C programs.

**ICS.** The baseline ICS course, designed to produce enlightened programmers who understand the impact of the hardware, operating system, and compilation system on the performance and correctness of their application programs. A significant difference from ORG+ is that low-level processor architecture is not covered. Instead, programmers work with a higher-level model of a modern out-of-order processor. The ICS course fits nicely into a 10-week quarter, and can also be stretched to a 15-week semester if covered at a more leisurely pace.

**ICS+.** The baseline ICS course with additional coverage of systems programming topics such as system-level I/O, network programming, and concurrent programming. This is the semester-long Carnegie Mellon course, which covers every chapter in CS:APP except low-level processor architecture.

**Figure 2 Five systems courses based on the CS:APP book.**

ICS+ is the 15–213 course from Carnegie Mellon. Notes: The **(c)** symbol denotes partial coverage of a chapter, as follows: (a) hardware only; (b) no dynamic storage allocation; (c) no dynamic linking; (d) no floating point.

**SP.** A systems programming course. This course is similar to ICS+, but it drops floating point and performance optimization, and it places more emphasis on systems programming, including process control, dynamic linking, system-level I/O, network programming, and concurrent programming. Instructors might want to supplement from other sources for advanced topics such as daemons, terminal control, and Unix IPC.

The main message of [Figure 2](#) is that the CS:APP book gives a lot of options to students and instructors. If you want your students to be exposed to lower-level processor architecture, then that option is available via the ORG and ORG+ courses. On the other hand, if you want to switch from your current computer organization course to an ICS or ICS+ course, but are wary of making such a drastic change all at once, then you can move toward ICS incrementally. You can start with ORG, which teaches the traditional topics in a nontraditional way. Once you are comfortable with that material, then you can move to ORG+, and eventually to ICS. If students have no experience in C (e.g., they have only programmed in Java), you could spend several weeks on C and then cover the material of ORG or ICS.

Finally, we note that the ORG+ and SP courses would make a nice two-term sequence (either quarters or semesters). Or you might consider offering ICS+ as one term of ICS and one term of SP.

# For Instructors: Classroom-Tested Laboratory Exercises


The ICS+ course at Carnegie Mellon receives very high evaluations from students. Median scores of 5.0/5.0 and means of 4.6/5.0 are typical for the student course evaluations. Students cite the fun, exciting, and relevant laboratory exercises as the primary reason. The labs are available from the CS:APP Web page. Here are examples of the labs that are provided with the book.

**Data Lab.** This lab requires students to implement simple logical and arithmetic functions, but using a highly restricted subset of C. For example, they must compute the absolute value of a number using only bit-level operations. This lab helps students understand the bit-level representations of C data types and the bit-level behavior of the operations on data.

**Binary Bomb Lab.** A *binary bomb* is a program provided to students as an object-code file. When run, it prompts the user to type in six different strings. If any of these are incorrect, the bomb "explodes," printing an error message and logging the event on a grading server. Students must "defuse" their own unique bombs by disassembling and reverse engineering the programs to determine what the six strings should be. The lab teaches students to understand assembly language and also forces them to learn how to use a debugger.



**Buffer Overflow Lab.** Students are required to modify the runtime behavior of a binary executable by exploiting a buffer overflow vulnerability. This lab teaches the students about the stack discipline and about the danger of writing code that is vulnerable to buffer overflow attacks.

**Architecture Lab.** Several of the homework problems of [Chapter 4](#)  can be combined into a lab assignment, where students modify the HCL description of a processor to add new instructions, change the branch prediction policy, or add or remove bypassing paths and register ports. The resulting processors can be simulated and run through automated tests that will detect most of the possible bugs. This lab lets students experience the exciting parts of processor design without requiring a complete background in logic design and hardware description languages.

**Performance Lab.** Students must optimize the performance of an application kernel function such as convolution or matrix transposition. This lab provides a very clear demonstration of the properties of cache memories and gives students experience with low-level program optimization.

**Cache Lab.** In this alternative to the performance lab, students write a general-purpose cache simulator, and then optimize a small matrix transpose kernel to minimize the number of misses on a simulated cache. We use the Valgrind tool to generate real address traces for the matrix transpose kernel.

**Shell Lab.** Students implement their own Unix shell program with job control, including the Ctrl+C and Ctrl+Z keystrokes and the `fg`, `bg`, and `jobs` commands. This is the student's first introduction to concurrency, and it gives them a clear idea of Unix process control, signals, and signal handling.

**Malloc Lab.** Students implement their own versions of `malloc`, `free`, and (optionally) `realloc`. This lab gives students a clear understanding of data layout and organization, and requires them to evaluate different trade-offs between space and time efficiency.

**Proxy Lab.** Students implement a concurrent Web proxy that sits between their browsers and the rest of the World Wide Web. This lab exposes the students to such topics as Web clients and servers, and ties together many of the concepts from the course, such as byte ordering, file I/O, process control, signals, signal handling, memory mapping, sockets, and concurrency. Students like being able to see their programs in action with real Web browsers and Web servers.

The CS:APP instructor's manual has a detailed discussion of the labs, as well as directions for downloading the support software.

# Acknowledgments for the Third Edition

It is a pleasure to acknowledge and thank those who have helped us produce this third edition of the CS:APP text.

We would like to thank our Carnegie Mellon colleagues who have taught the ICS course over the years and who have provided so much insightful feedback and encouragement: Guy Blelloch, Roger Dannenberg, David Eckhardt, Franz Franchetti, Greg Ganger, Seth Goldstein, Khaled Harras, Greg Kesden, Bruce Maggs, Todd Mowry, Andreas Nowatzyk, Frank Pfenning, Markus Pueschel, and Anthony Rowe. David Winters was very helpful in installing and configuring the reference Linux box.

Jason Fritts (St. Louis University) and Cindy Norris (Appalachian State) provided us with detailed and thoughtful reviews of the second edition. Yili Gong (Wuhan University) wrote the Chinese translation, maintained the errata page for the Chinese version, and contributed many bug reports. Godmar Back (Virginia Tech) helped us improve the text significantly by introducing us to the notions of async-signal safety and protocol-independent network programming.

Many thanks to our eagle-eyed readers who reported bugs in the second edition: Rami Ammari, Paul Anagnostopoulos, Lucas Bärenfänger, Godmar Back, Ji Bin, Sharbel Bousemaan, Richard

Callahan, Seth Chaiken, Cheng Chen, Libo Chen, Tao Du, Pascal Garcia, Yili Gong, Ronald Greenberg, Dorukhan Gülöz, Dong Han, Dominik Helm, Ronald Jones, Mustafa Kazdagli, Gordon Kindlmann, Sankar Krishnan, Kanak Kshetri, Junlin Lu, Qiangqiang Luo, Sebastian Luy, Lei Ma, Ashwin Nanjappa, Gregoire Paradis, Jonas Pfenninger, Karl Pichotta, David Ramsey, Kaustabh Roy, David Selvaraj, Sankar Shanmugam, Dominique Smulkowska, Dag Sørbrø, Michael Spear, Yu Tanaka, Steven Tricanowicz, Scott Wright, Waiki Wright, Han Xu, Zhengshan Yan, Firo Yang, Shuang Yang, John Ye, Taketo Yoshida, Yan Zhu, and Michael Zink.

Thanks also to our readers who have contributed to the labs, including God-mar Back (Virginia Tech), Taymon Beal (Worcester Polytechnic Institute), Aran Clauson (Western Washington University), Cary Gray (Wheaton College), Paul Haiduk (West Texas A&M University), Len Hamey (Macquarie University), Eddie Kohler (Harvard), Hugh Lauer (Worcester Polytechnic Institute), Robert Marmorstein (Longwood University), and James Riely (DePaul University).

Once again, Paul Anagnostopoulos of Windfall Software did a masterful job of typesetting the book and leading the production process. Many thanks to Paul and his stellar team: Richard Camp (copyediting), Jennifer McClain (proofreading), Laurel Muller (art production), and Ted Laux (indexing). Paul even spotted a bug in our description of the origins of the acronym BSS that had persisted undetected since the first edition!

Finally, we would like to thank our friends at Prentice Hall. Marcia Horton and our editor, Matt Goldstein, have been unflagging in their support and encouragement, and we are deeply grateful to them.

# Acknowledgments from the Second Edition

We are deeply grateful to the many people who have helped us produce this second edition of the CS:APP text.

First and foremost, we would like to recognize our colleagues who have taught the ICS course at Carnegie Mellon for their insightful feedback and encouragement: Guy Blelloch, Roger Dannenberg, David Eckhardt, Greg Ganger, Seth Goldstein, Greg Kesden, Bruce Maggs, Todd Mowry, Andreas Nowatzyk, Frank Pfenning, and Markus Pueschel.

Thanks also to our sharp-eyed readers who contributed reports to the errata page for the first edition: Daniel Amelang, Rui Baptista, Quarup Barreirinhas, Michael Bombyk, Jörg Brauer, Jordan Brough, Yixin Cao, James Carroll, Rui Carvalho, Hyung-Kee Choi, Al Davis, Grant Davis, Christian Dufour, Mao Fan, Tim Freeman, Inge Frick, Max Gebhardt, Jeff Goldblat, Thomas Gross, Anita Gupta, John Hampton, Hiep Hong, Greg Israelsen, Ronald Jones, Haudy Kazemi, Brian Kell, Constantine Kousoulis, Sacha Krakowiak, Arun Krishnaswamy, Martin Kulas, Michael Li, Zeyang Li, Ricky Liu, Mario Lo Conte, Dirk Maas, Devon Macey, Carl Marcinik, Will Marrero, Simone Martins, Tao Men, Mark Morrissey, Venkata Naidu, Bhas Nalabothula, Thomas Niemann, Eric Peskin, David Po, Anne Rogers, John Ross, Michael Scott, Seiki, Ray Shih, Darren Shultz,

Erik Silkensen, Suryanto, Emil Tarazi, Nawanan Theera-Ampornpunt, Joe Trdinich, Michael Trigoboff, James Troup, Martin Vopatek, Alan West, Betsy Wolff, Tim Wong, James Woodruff, Scott Wright, Jackie Xiao, Guanpeng Xu, Qing Xu, Caren Yang, Yin Yongsheng, Wang Yuanxuan, Steven Zhang, and Day Zhong. Special thanks to Inge Frick, who identified a subtle deep copy bug in our lock-and-copy example, and to Ricky Liu for his amazing proofreading skills.

Our Intel Labs colleagues Andrew Chien and Limor Fix were exceptionally supportive throughout the writing of the text. Steve Schlosser graciously provided some disk drive characterizations. Casey Helfrich and Michael Ryan installed and maintained our new Core i7 box. Michael Kozuch, Babu Pillai, and Jason Campbell provided valuable insight on memory system performance, multi-core systems, and the power wall. Phil Gibbons and Shimin Chen shared their considerable expertise on solid state disk designs.

We have been able to call on the talents of many, including Wen-Mei Hwu, Markus Pueschel, and Jiri Simsa, to provide both detailed comments and high-level advice. James Hoe helped us create a Verilog version of the Y86 processor and did all of the work needed to synthesize working hardware.

Many thanks to our colleagues who provided reviews of the draft manuscript: James Archibald (Brigham Young University), Richard Carver (George Mason University), Mirela Damian (Villanova University), Peter Dinda (Northwestern University), John Fiore

(Temple University), Jason Fritts (St. Louis University), John Greiner (Rice University), Brian Harvey (University of California, Berkeley), Don Heller (Penn State University), Wei Chung Hsu (University of Minnesota), Michelle Hugue (University of Maryland), Jeremy Johnson (Drexel University), Geoff Kuenning (Harvey Mudd College), Ricky Liu, Sam Madden (MIT), Fred Martin (University of Massachusetts, Lowell), Abraham Matta (Boston University), Markus Pueschel (Carnegie Mellon University), Norman Ramsey (Tufts University), Glenn Reinmann (UCLA), Michela Taufer (University of Delaware), and Craig Zilles (UIUC).

Paul Anagnostopoulos of Windfall Software did an outstanding job of typesetting the book and leading the production team. Many thanks to Paul and his superb team: Rick Camp (copyeditor), Joe Snowden (compositor), MaryEllen N. Oliver (proofreader), Laurel Muller (artist), and Ted Laux (indexer).

Finally, we would like to thank our friends at Prentice Hall. Marcia Horton has always been there for us. Our editor, Matt Goldstein, provided stellar leadership from beginning to end. We are profoundly grateful for their help, encouragement, and insights.



# Acknowledgments from the First Edition

We are deeply indebted to many friends and colleagues for their thoughtful criticisms and encouragement. A special thanks to our 15–213 students, whose infectious energy and enthusiasm spurred us on. Nick Carter and Vinny Furia generously provided their malloc package.

Guy Blelloch, Greg Kesden, Bruce Maggs, and Todd Mowry taught the course over multiple semesters, gave us encouragement, and helped improve the course material. Herb Derby provided early spiritual guidance and encouragement. Allan Fisher, Garth Gibson, Thomas Gross, Satya, Peter Steenkiste, and Hui Zhang encouraged us to develop the course from the start. A suggestion from Garth early on got the whole ball rolling, and this was picked up and refined with the help of a group led by Allan Fisher. Mark Stehlik and Peter Lee have been very supportive about building this material into the undergraduate curriculum. Greg Kesden provided helpful feedback on the impact of ICS on the OS course. Greg Ganger and Jiri Schindler graciously provided some disk drive characterizations and answered our questions on modern disks. Tom Stricker showed us the memory mountain. James Hoe provided useful ideas and feedback on how to present processor architecture.

A special group of students—Khalil Amiri, Angela Demke Brown, Chris Colohan, Jason Crawford, Peter Dinda, Julio Lopez, Bruce Lowekamp, Jeff Pierce, Sanjay Rao, Balaji Sarpeshkar, Blake Scholl, Sanjit Seshia, Greg Steffan, Tiankai Tu, Kip Walker, and Yinglian Xie—were instrumental in helping us develop the content of the course. In particular, Chris Colohan established a fun (and funny) tone that persists to this day, and invented the legendary "binary bomb" that has proven to be a great tool for teaching machine code and debugging concepts.

Chris Bauer, Alan Cox, Peter Dinda, Sandhya Dwarkadas, John Greiner, Don Heller, Bruce Jacob, Barry Johnson, Bruce Lowekamp, Greg Morrisett, Brian Noble, Bobbie Othmer, Bill Pugh, Michael Scott, Mark Smotherman, Greg Steffan, and Bob Wier took time that they did not have to read and advise us on early drafts of the book. A very special thanks to Al Davis (University of Utah), Peter Dinda (Northwestern University), John Greiner (Rice University), Wei Hsu (University of Minnesota), Bruce Lowekamp (College of William & Mary), Bobbie Othmer (University of Minnesota), Michael Scott (University of Rochester), and Bob Wier (Rocky Mountain College) for class testing the beta version. A special thanks to their students as well!

We would also like to thank our colleagues at Prentice Hall. Marcia Horton, Eric Frank, and Harold Stone have been unflagging in their support and vision. Harold also helped us present an accurate historical perspective on RISC and CISC processor architectures.

Jerry Ralya provided sharp insights and taught us a lot about good writing.

Finally, we would like to acknowledge the great technical writers Brian Kernighan and the late W. Richard Stevens, for showing us that technical books can be beautiful.

Thank you all.

**Randy Bryant**

**Dave O'Hallaron**

*Pittsburgh, Pennsylvania*

[OceanofPDF.com](http://OceanofPDF.com)

# About the Authors



**Randal E. Bryant** received his bachelor's degree from the University of Michigan in 1973 and then attended graduate school at the Massachusetts Institute of Technology, receiving his PhD degree in computer science in 1981. He spent three years as an assistant professor at the California Institute of Technology, and has been on the faculty at Carnegie Mellon since 1984. For five of those years he served as head of the Computer Science Department, and for ten of them he served as Dean of the School of Computer Science. He is currently a university professor of computer science. He also holds a courtesy appointment with the Department of Electrical and Computer Engineering.

Professor Bryant has taught courses in computer systems at both the undergraduate and graduate level for around 40 years. Over many years of teaching computer architecture courses, he began shifting the focus from how computers are designed to how programmers can write more efficient and reliable programs if they understand the system better. Together with Professor O'Hallaron, he developed the course 15–213, Introduction to Computer Systems, at Carnegie Mellon that is the basis for this book. He has

also taught courses in algorithms, programming, computer networking, distributed systems, and VLSI design.

Most of Professor Bryant's research concerns the design of software tools to help software and hardware designers verify the correctness of their systems. These include several types of simulators, as well as formal verification tools that prove the correctness of a design using mathematical methods. He has published over 150 technical papers. His research results are used by major computer manufacturers, including Intel, IBM, Fujitsu, and Microsoft. He has won several major awards for his research. These include two inventor recognition awards and a technical achievement award from the Semiconductor Research Corporation, the Kanellakis Theory and Practice Award from the Association for Computer Machinery (ACM), and the W. R. G. Baker Award, the Emmanuel Piore Award, the Phil Kaufman Award, and the A. Richard Newton Award from the Institute of Electrical and Electronics Engineers (IEEE). He is a fellow of both the ACM and the IEEE and a member of both the US National Academy of Engineering and the American Academy of Arts and Sciences.



**David R. O'Hallaron** is a professor of computer science and electrical and computer engineering at Carnegie Mellon University. He received his PhD from the University of Virginia. He served as the director of Intel Labs, Pittsburgh, from 2007 to 2010.

He has taught computer systems courses at the undergraduate and graduate levels for 20 years on such topics as computer architecture, introductory computer systems, parallel processor design, and Internet services. Together with Professor Bryant, he developed the course at Carnegie Mellon that led to this book. In 2004, he was awarded the Herbert Simon Award for Teaching Excellence by the CMU School of Computer Science, an award for which the winner is chosen based on a poll of the students.

Professor O'Hallaron works in the area of computer systems, with specific interests in software systems for scientific computing, data-intensive computing, and virtualization. The best-known example of his work is the Quake project, an endeavor involving a group of computer scientists, civil engineers, and seismologists who have developed the ability to predict the motion of the ground during strong earthquakes. In 2003, Professor O'Hallaron and the other

members of the Quake team won the Gordon Bell Prize, the top international prize in high-performance computing. His current work focuses on the notion of autograding, that is, programs that evaluate the quality of other programs.

[OceanofPDF.com](http://OceanofPDF.com)



---

# Chapter **1** A Tour of Computer Systems

---

**1.1 Information Is Bits + Context 3** 

**1.2 Programs Are Translated by Other Programs into Different Forms 4** 

**1.3 It Pays to Understand How Compilation Systems Work 6** 

**1.4 Processors Read and Interpret Instructions Stored in Memory 7** 

**1.5 Caches Matter 11** 

**1.6 Storage Devices Form a Hierarchy 14** 

**1.7 The Operating System Manages the Hardware 14** 

**1.8 Systems Communicate with Other Systems Using Networks 19** 

**1.9 Important Themes 22** 

**1.10 Summary 27** 

**Bibliographic Notes 28** 

**Solutions to Practice Problems 28** 

*A computer system consists of hardware and systems software that work together to run application programs. Specific implementations of systems change over time, but the underlying concepts do not. All computer systems have similar hardware and software components that perform similar functions. This book is written for programmers who want to get better at their craft by understanding how these components work and how they affect the correctness and performance of their programs.*

*You are poised for an exciting journey. If you dedicate yourself to learning the concepts in this book, then you will be on your way to becoming a rare "power programmer," enlightened by an understanding of the underlying computer system and its impact on your application programs.*

*You are going to learn practical skills such as how to avoid strange numerical errors caused by the way that computers represent numbers. You will learn how to optimize your C code by using clever tricks that exploit the designs of modern processors and memory systems. You will learn how the compiler implements*

*procedure calls and how to use this knowledge to avoid the security holes from buffer overflow vulnerabilities that plague network and Internet software. You will learn how to recognize and avoid the nasty errors during linking that confound the average programmer. You will learn how to write your own Unix shell, your own dynamic storage allocation package, and even your own Web server. You will learn the promises and pitfalls of concurrency, a topic of increasing importance as multiple processor cores are integrated onto single chips.*

*In their classic text on the C programming language [61], Kernighan and Ritchie introduce readers to C using the `hello` program shown in **Figure 1.1**. Although `hello` is a very simple program, every major part of the system must work in concert in order for it to run to completion. In a sense, the goal of this book is to help you understand what happens and why when you run `hello` on your system.*

*We begin our study of systems by tracing the lifetime of the `hello` program, from the time it is created by a programmer, until it runs on a system, prints its simple message, and*

*terminates. As we follow the lifetime of the program, we will briefly introduce the key concepts, terminology, and components that come into play. Later chapters will expand on these ideas.*

---

*code/intro/hello.c*

```
|  
1 #include <stdio.h>  
2  
3 int main()  
4 {  
5     printf("hello, world\n");  
6     return 0;  
7 }
```

---

*code/intro/hello.c*

**Figure 1.1** The `hello` program.

(Source: [60])


#	i	n	c	l	u	d	e
SP	<	s	t	d	i	o	.
35	105	110	99	108	117	100	101
32	60	115	116	100	105	111	46
h	>	\n	\n	i	n	t	SP
m	a	i	n	(	)	\n	{
104	62	10	10	105	110	116	32
109	97	105	110	40	41	10	123
\n	SP	SP	SP	SP	p	r	i
n	t	f	(	"	h	e	l
10	32	32	32	32	112	114	105
110	116	102	40	34	104	101	108
l	o	,	SP	w	o	r	l
d	\	n	"	)	;	\n	SP
108	111	44	32	119	111	114	108
100	92	110	34	41	59	10	32
SP	SP	SP	r	e	t	u	r
n	SP	0	;	\n	}	\n	
32	32	32	114	101	116	117	114
110	32	48	59	10	125	10	

**Figure 1.2 The ASCII text representation of**  
`hello.c.`

[OceanofPDF.com](http://OceanofPDF.com)

# 1.1 Information Is Bits + Context

Our `hello` program begins life as a *source program* (or *source file*) that the programmer creates with an editor and saves in a text file called `hello.c`. The source program is a sequence of bits, each with a value of 0 or 1, organized in 8-bit chunks called *bytes*. Each byte represents some text character in the program.

Most computer systems represent text characters using the ASCII standard that represents each character with a unique byte-size integer value.<sup>1</sup> For example, [Figure 1.2](#)  shows the ASCII representation of the `hello.c` program.

**1.** Other encoding methods are used to represent text in non-English languages. See the aside on page 50 for a discussion on this.

The `hello.c` program is stored in a file as a sequence of bytes. Each byte has an integer value that corresponds to some character. For example, the first byte has the integer value 35, which corresponds to the character ``#'`. The second byte has the integer value 105, which corresponds to the character `'i'`, and so on. Notice that each text line is terminated by the invisible *newline* character ``\n'`, which is represented by the integer value 10. Files such as `hello.c` that consist exclusively of ASCII characters are known as *text files*. All other files are known as *binary files*.



The representation of `hello.c` illustrates a fundamental idea: All information in a system—including disk files, programs stored in memory, user data stored in memory, and data transferred across a network—is represented as a bunch of bits. The only thing that distinguishes different data objects is the context in which we view them. For example, in different contexts, the same sequence of bytes might represent an integer, floating-point number, character string, or machine instruction.

As programmers, we need to understand machine representations of numbers because they are not the same as integers and real numbers. They are finite

# Aside Origins of the C programming language


C was developed from 1969 to 1973 by Dennis Ritchie of Bell Laboratories. The American National Standards Institute (ANSI) ratified the ANSI C standard in 1989, and this standardization later became the responsibility of the International Standards Organization (ISO). The standards define the C language and a set of library functions known as the *C standard library*. Kernighan and Ritchie describe ANSI C in their classic book, which is known affectionately as "K&R" [61]. In Ritchie's words [92], C is "quirky, flawed, and an enormous success." So why the success?

- **C was closely tied with the Unix operating system.** C was developed from the beginning as the system programming language for Unix. Most of the Unix kernel (the core part of the operating system), and all of its supporting tools and libraries, were written in C. As Unix became popular in universities in the late 1970s and early 1980s, many people were exposed to C and found that they liked it. Since Unix was written almost entirely in C, it could be easily ported to new machines, which created an even wider audience for both C and Unix.
- **C is a small, simple language.** The design was controlled by a single person, rather than a committee, and the result was a clean, consistent design with little baggage. The K&R book describes the complete language

and standard library, with numerous examples and exercises, in only 261 pages. The simplicity of C made it relatively easy to learn and to port to different computers.

- **C was designed for a practical purpose.** C was designed to implement the Unix operating system. Later, other people found that they could write the programs they wanted, without the language getting in the way.

C is the language of choice for system-level programming, and there is a huge installed base of application-level programs as well. However, it is not perfect for all programmers and all situations. C pointers are a common source of confusion and programming errors. C also lacks explicit support for useful abstractions such as classes, objects, and exceptions. Newer languages such as C++ and Java address these issues for application-level programs.

approximations that can behave in unexpected ways. This fundamental idea is explored in detail in [Chapter 2](#) .

# 1.2 Programs Are Translated by Other Programs into Different Forms

The `hello` program begins life as a high-level C program because it can be read and understood by human beings in that form. However, in order to run `hello.c` on the system, the individual C statements must be translated by other programs into a sequence of low-level *machine-language* instructions. These instructions are then packaged in a form called an *executable object program* and stored as a binary disk file. Object programs are also referred to as *executable object files*.

On a Unix system, the translation from source file to object file is performed by a *compiler driver*:

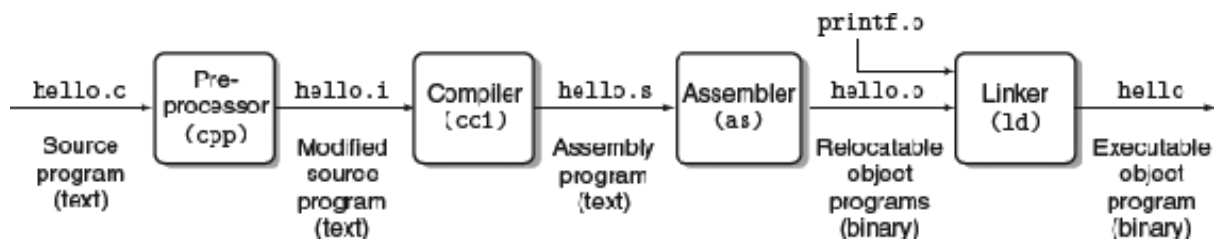


Figure 1.3 The compilation system.

```
linux> gcc -o hello hello.c
```

Here, the `gcc` compiler driver reads the source file `hello.c` and translates it into an executable object file `hello`. The translation is performed in the sequence of four phases shown in [Figure 1.3](#). The programs that perform the four phases (*preprocessor*, *compiler*, *assembler*, and *linker*) are known collectively as the *compilation system*.

- **Preprocessing phase.** The preprocessor (`cpp`) modifies the original C program according to directives that begin with the `#` character. For example, the `#include <stdio.h>` command in line 1 of `hello.c` tells the preprocessor to read the contents of the system header file `stdio.h` and insert it directly into the program text. The result is another C program, typically with the `.i` suffix.
- **Compilation phase.** The compiler (`cc1`) translates the text file `hello.i` into the text file `hello.s`, which contains an *assembly-language program*. This program includes the following definition of `function main`:

```
|
1  main:
2  subq    $8, %rsp
3  movl    $.LC0, %edi
4  call    puts
5  movl    $0, %eax
6  addq    $8, %rsp
7  ret
```

Each of lines 2-7 in this definition describes one low-level machine-language instruction in a textual form. Assembly language is useful because it provides a common output language for different compilers for different high-level languages. For example, C compilers and Fortran compilers both generate output files in the same assembly language.

- **Assembly phase.** Next, the assembler (`as`) translates `hello.s` into machine-language instructions, packages them in a form known as a *relocatable object program*, and stores the result in the object file `hello.o`. This file is a binary file containing 17 bytes to encode the instructions for function `main`. If we were to view `hello.o` with a text editor, it would appear to be gibberish.

## Aside The GNU project

Gcc is one of many useful tools developed by the GNU (short for GNU's Not Unix) project. The GNU project is a tax-exempt charity started by Richard Stallman in 1984, with the ambitious goal of developing a complete Unix-like system whose source code is unencumbered by restrictions on how it can be modified or distributed. The GNU project has developed an environment with all the major components of a Unix operating system, except for the kernel, which was developed separately by the Linux project. The GNU environment includes the `EMACS` editor, `GCC` compiler, `GDB` debugger, assembler, linker, utilities for manipulating binaries, and other components. The `GCC` compiler has grown to support many different languages, with the ability to generate code for many different machines. Supported languages include C, C++, Fortran, Java, Pascal, Objective-C, and Ada.

The GNU project is a remarkable achievement, and yet it is often overlooked. The modern open-source movement (commonly associated with Linux) owes its intellectual origins to the GNU project's notion of *free software* ("free" as in "free speech," not "free beer"). Further, Linux owes much of its popularity to the GNU tools, which provide the environment for the Linux kernel.

- **Linking phase.** Notice Notice that our `hello` program calls the `printf` function, which is part of the *standard C library* provided

by every C compiler. The `printf` function resides in a separate precompiled object file called `printf.o`, which must somehow be merged with our `hello.o` program. The linker (`ld`) handles this merging. The result is the `hello` file, which is an executable object file (or simply *executable*) that is ready to be loaded into memory and executed by the system.

[OceanofPDF.com](http://OceanofPDF.com)




# 1.3 It Pays to Understand How Compilation Systems Work

For simple programs such as `hello.c`, we can rely on the compilation system to produce correct and efficient machine code. However, there are some important reasons why programmers need to understand how compilation systems work:

- **Optimizing program performance.** Modern compilers are sophisticated tools that usually produce good code. As programmers, we do not need to know the inner workings of the compiler in order to write efficient code. However, in order to make good coding decisions in our C programs, we do need a basic understanding of machine-level code and how the compiler translates different C statements into machine code. For example, is a `switch` statement always more efficient than a sequence of `if-else` statements? How much overhead is incurred by a function call? Is a `while` loop more efficient than a `for` loop? Are pointer references more efficient than array indexes? Why does our loop run so much faster if we sum into a local variable instead of an argument that is passed by reference? How can a function run faster when we simply rearrange the parentheses in an arithmetic expression?

In [Chapter 3](#), we introduce x86-64, the machine language of recent generations of Linux, Macintosh, and Windows computers. We describe how compilers translate different C constructs into this language. In [Chapter 5](#), you will learn how to tune the performance of your C programs by making simple transformations to the C code that help the compiler do its job better. In [Chapter 6](#), you will learn about the hierarchical nature of the memory system, how C compilers store data arrays in memory, and how your C programs can exploit this knowledge to run more efficiently.

- **Understanding link-time errors.** In our experience, some of the most perplexing programming errors are related to the operation of the linker, especially when you are trying to build large software systems. For example, what does it mean when the linker reports that it cannot resolve a reference? What is the difference between a static variable and a global variable? What happens if you define two global variables in different C files with the same name? What is the difference between a static library and a dynamic library? Why does it matter what order we list libraries on the command line? And scariest of all, why do some linker-related errors not appear until run time? You will learn the answers to these kinds of questions in [Chapter 7](#).
- **Avoiding security holes.** For many years, *buffer overflow vulnerabilities* have accounted for many of the security holes in network and Internet servers. These vulnerabilities exist because too few programmers understand the need to carefully restrict the quantity and forms of data they accept from untrusted sources. A first step in learning secure programming is to understand the

consequences of the way data and control information are stored on the program stack. We cover the stack discipline and buffer overflow vulnerabilities in **Chapter 3**  as part of our study of assembly language. We will also learn about methods that can be used by the programmer, compiler, and operating system to reduce the threat of attack.

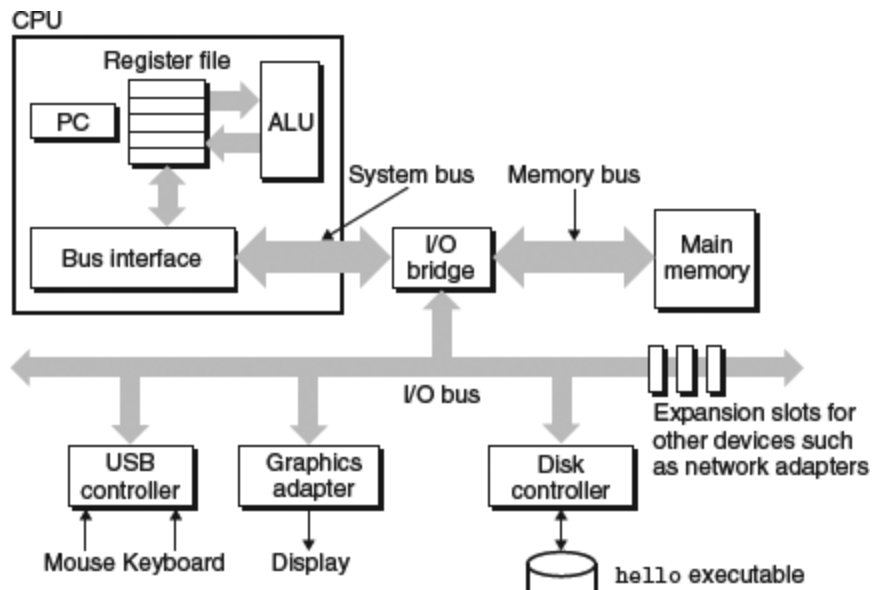
[OceanofPDF.com](http://OceanofPDF.com)

# 1.4 Processors Read and Interpret Instructions Stored in Memory

At this point, our `hello.c` source program has been translated by the compilation system into an executable object file called `hello` that is stored on disk. To run the executable file on a Unix system, we type its name to an application program known as a *shell*:

```
|  
linux> ./hello  
hello, world  
linux>
```

The shell is a command-line interpreter that prints a prompt, waits for you to type a command line, and then performs the command. If the first word of the command line does not correspond to a built-in shell command, then the shell



**Figure 1.4 Hardware organization of a typical system.**

CPU: central processing unit, ALU: arithmetic/logic unit, PC: program counter, USB: Universal Serial Bus.

assumes that it is the name of an executable file that it should load and run. So in this case, the shell loads and runs the `hello` program and then waits for it to terminate. The `hello` program prints its message to the screen and then terminates. The shell then prints a prompt and waits for the next input command line.

# 1.4.1 Hardware Organization of a System

To understand what happens to our `hello` program when we run it, we need to understand the hardware organization of a typical system, which is shown in [Figure 1.4](#). This particular picture is modeled after the family of recent Intel systems, but all systems have a similar look and feel. Don't worry about the complexity of this figure just now. We will get to its various details in stages throughout the course of the book.



## *Buses*

Running throughout the system is a collection of electrical conduits called *buses* that carry bytes of information back and forth between the components. Buses are typically designed to transfer fixed-size chunks of bytes known as *words*. The number of bytes in a word (the *word size*) is a fundamental system parameter that varies across systems. Most machines today have word sizes of either 4 bytes (32 bits) or 8 bytes (64 bits). In this book, we do not assume any fixed definition of word size. Instead, we will specify what we mean by a "word" in any context that requires this to be defined.

# I/O Devices


Input/output (I/O) devices are the system's connection to the external world. Our example system has four I/O devices: a keyboard and mouse for user input, a display for user output, and a disk drive (or simply disk) for long-term storage of data and programs. Initially, the executable `hello` program resides on the disk.

Each I/O device is connected to the I/O bus by either a *controller* or an *adapter*. The distinction between the two is mainly one of packaging. Controllers are chip sets in the device itself or on the system's main printed circuit board (often called the *motherboard*). An adapter is a card that plugs into a slot on the motherboard. Regardless, the purpose of each is to transfer information back and forth between the I/O bus and an I/O device.

**Chapter 6**  has more to say about how I/O devices such as disks work. In **Chapter 10** , you will learn how to use the Unix I/O interface to access devices from your application programs. We focus on the especially interesting class of devices known as networks, but the techniques generalize to other kinds of devices as well.

# Main Memory

The *main memory* is a temporary storage device that holds both a program and the data it manipulates while the processor is executing the program. Physically, main memory consists of a collection of *dynamic random access memory*(DRAM) chips. Logically, memory is organized as a linear array of bytes, each with its own unique address (array index) starting at zero. In general, each of the machine instructions that constitute a program can consist of a variable number of bytes. The sizes of data items that correspond to C program variables vary according to type. For example, on an x86-64 machine running Linux, data of type `short` require 2 bytes, types `int` and `float` 4 bytes, and types `long` and `double` 8 bytes.

**Chapter 6**  has more to say about how memory technologies such as DRAM chips work, and how they are combined to form main memory.



# Processor

The *central processing unit* (CPU), or simply *processor*, is the engine that interprets (or *executes*) instructions stored in main memory. At its core is a word-size storage device (or *register*) called the *program counter* (PC). At any point in time, the PC points at (contains the address of) some machine-language instruction in main memory.<sup>2</sup>

2. PC is also a commonly used acronym for "personal computer." However, the distinction between the two should be clear from the context.

From the time that power is applied to the system until the time that the power is shut off, a processor repeatedly executes the instruction pointed at by the program counter and updates the program counter to point to the next instruction. A processor *appears* to operate according to a very simple instruction execution model, defined by its *instruction set architecture*. In this model, instructions execute in strict sequence, and executing a single instruction involves performing a series of steps. The processor reads the instruction from memory pointed at by the program counter (PC), interprets the bits in the instruction, performs some simple operation dictated by the instruction, and then updates the PC to point to the next instruction, which may or may not be contiguous in memory to the instruction that was just executed.

There are only a few of these simple operations, and they revolve around main memory, the *register file*, and the *arithmetic/logic unit* (ALU). The register file is a small storage device that consists of a collection of word-size registers, each with its own unique name. The


ALU computes new data and address values. Here are some examples of the simple operations that the CPU might carry out at the request of an instruction:

- **Load:** Copy a byte or a word from main memory into a register, overwriting the previous contents of the register.
- **Store:** Copy a byte or a word from a register to a location in main memory, overwriting the previous contents of that location.
- **Operate:** Copy the contents of two registers to the ALU, perform an arithmetic operation on the two words, and store the result in a register, overwriting the previous contents of that register.
- **Jump:** Extract a word from the instruction itself and copy that word into the program counter (PC), overwriting the previous value of the PC.

We say that a processor appears to be a simple implementation of its instruction set architecture, but in fact modern processors use far more complex mechanisms to speed up program execution. Thus, we can distinguish the processor's instruction set architecture, describing the effect of each machine-code instruction, from its *microarchitecture*, describing how the processor is actually implemented. When we study machine code in [Chapter 3](#), we will consider the abstraction provided by the machine's instruction set architecture. [Chapter 4](#) has more to say about how processors are actually implemented. [Chapter 5](#) describes a model of how modern processors work that enables predicting and optimizing the performance of machine-language programs.

## 1.4.2 Running the `hello` Program

Given this simple view of a system's hardware organization and operation, we can begin to understand what happens when we run our example program. We must omit a lot of details here that will be filled in later, but for now we will be content with the big picture.

Initially, the shell program is executing its instructions, waiting for us to type a command. As we type the characters `./hello` at the keyboard, the shell program reads each one into a register and then stores it in memory, as shown in [Figure 1.5](#) .

When we hit the enter key on the keyboard, the shell knows that we have finished typing the command. The shell then loads the executable `hello` file by executing a sequence of instructions that copies the code and data in the `hello`

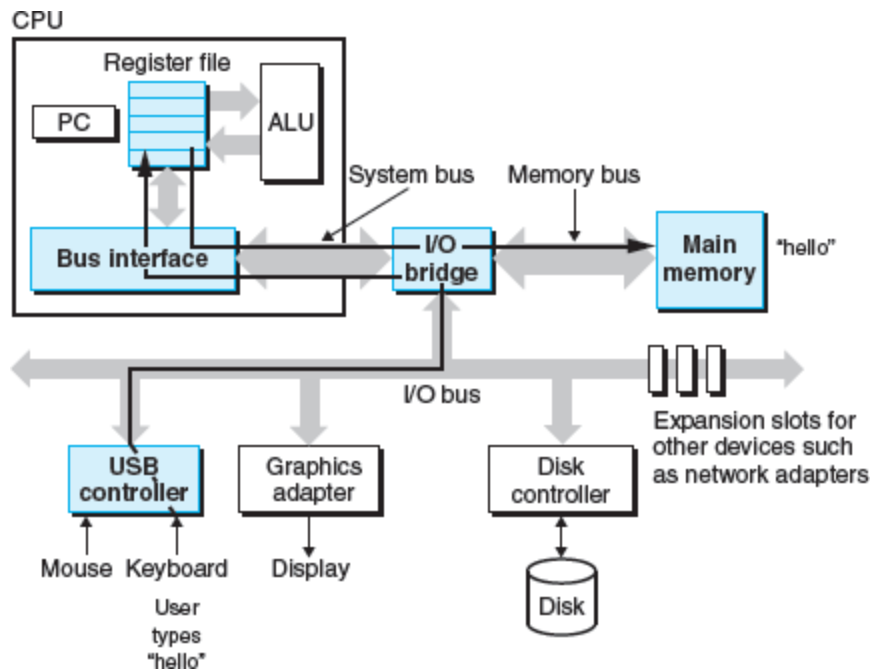


Figure 1.5 Reading the `hello` command from the keyboard.

object file from disk to main memory. The data includes the string of characters `hello, world\n` that will eventually be printed out.

Using a technique known as *direct memory access* (DMA, discussed in [Chapter 6](#)), the data travel directly from disk to main memory, without passing through the processor. This step is shown in [Figure 1.6](#).

Once the code and data in the `hello` object file are loaded into memory, the processor begins executing the machine-language instructions in the `hello` program's `main` routine. These instructions copy the bytes in the `hello, world\n` string from memory to the register file, and from there to the display device, where they are displayed on the screen. This step is shown in [Figure 1.7](#).

[OceanofPDF.com](http://OceanofPDF.com)

## 1.5 Caches Matter

An important lesson from this simple example is that a system spends a lot of time moving information from one place to another. The machine instructions in the `hello` program are originally stored on disk. When the program is loaded, they are copied to main memory. As the processor runs the program, instructions are copied from main memory into the processor. Similarly, the data string `hello, world\n`, originally on disk, is copied to main memory and then copied from main memory to the display device. From a programmer's perspective, much of this copying is overhead that slows down the "real work" of the program. Thus, a major goal for system designers is to make these copy operations run as fast as possible.

Because of physical laws, larger storage devices are slower than smaller storage devices. And faster devices are more expensive to build than their slower

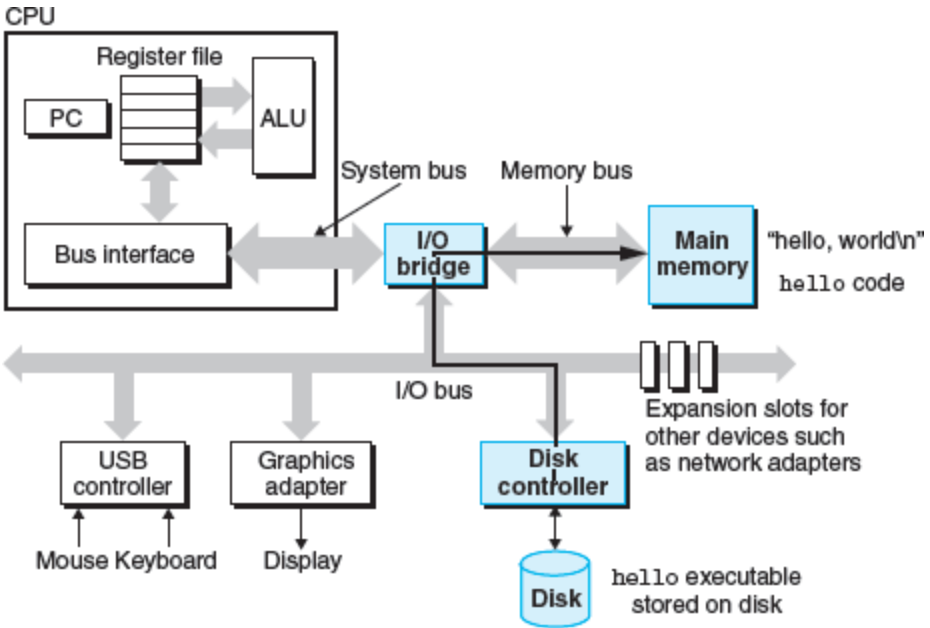


Figure 1.6 Loading the executable from disk into main memory.

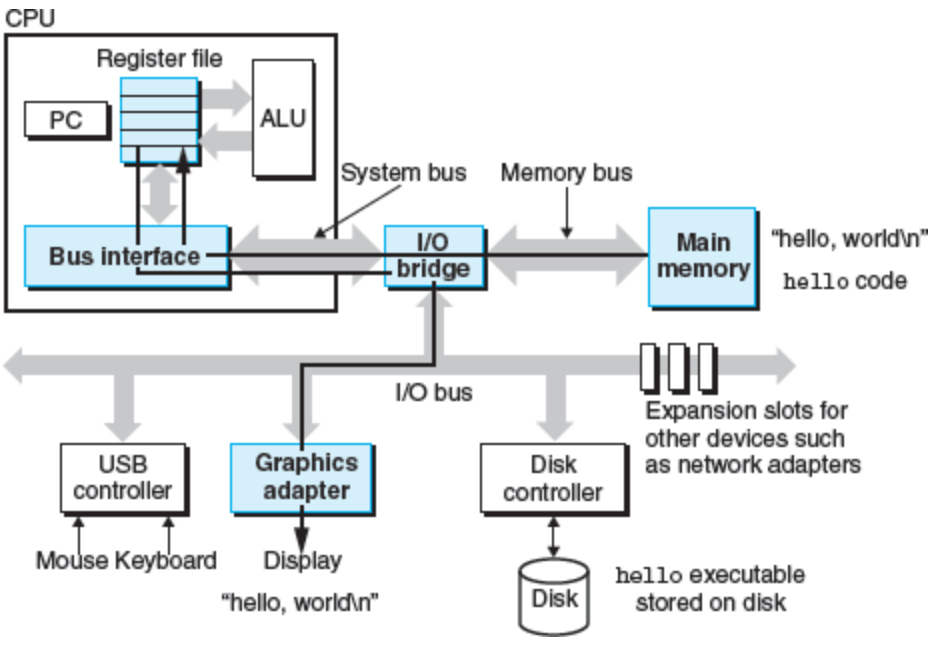
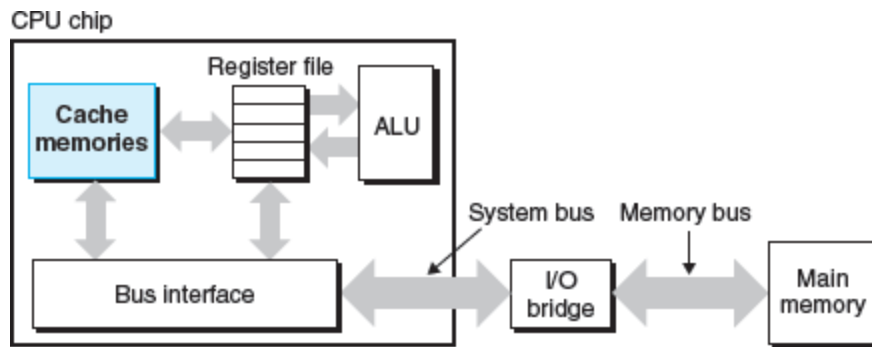


Figure 1.7 Writing the output string from memory to the display.



**Figure 1.8 Cache memories.**


counterparts. For example, the disk drive on a typical system might be 1,000 times larger than the main memory, but it might take the processor 10,000,000 times longer to read a word from disk than from memory.

Similarly, a typical register file stores only a few hundred bytes of information, as opposed to billions of bytes in the main memory. However, the processor can read data from the register file almost 100 times faster than from memory. Even more troublesome, as semiconductor technology progresses over the years, this *processor-memory gap* continues to increase. It is easier and cheaper to make processors run faster than it is to make main memory run faster.

To deal with the processor-memory gap, system designers include smaller, faster storage devices called *cache memories* (or simply caches) that serve as temporary staging areas for information that the processor is likely to need in the near future. [Figure 1.8](#) shows the cache memories in a typical system. An *L1 cache* on the processor chip holds tens of thousands of bytes and can be



accessed nearly as fast as the register file. A larger *L2 cache* with hundreds of thousands to millions of bytes is connected to the processor by a special bus. It might take 5 times longer for the processor to access the L2 cache than the L1 cache, but this is still 5 to 10 times faster than accessing the main memory. The L1 and L2 caches are implemented with a hardware technology known as *static random access memory* (SRAM). Newer and more powerful systems even have three levels of cache: L1, L2, and L3. The idea behind caching is that a system can get the effect of both a very large memory and a very fast one by exploiting *locality*, the tendency for programs to access data and code in localized regions. By setting up caches to hold data that are likely to be accessed often, we can perform most memory operations using the fast caches.

One of the most important lessons in this book is that application programmers who are aware of cache memories can exploit them to improve the performance of their programs by an order of magnitude. You will learn more about these important devices and how to exploit them in [Chapter 6](#) .

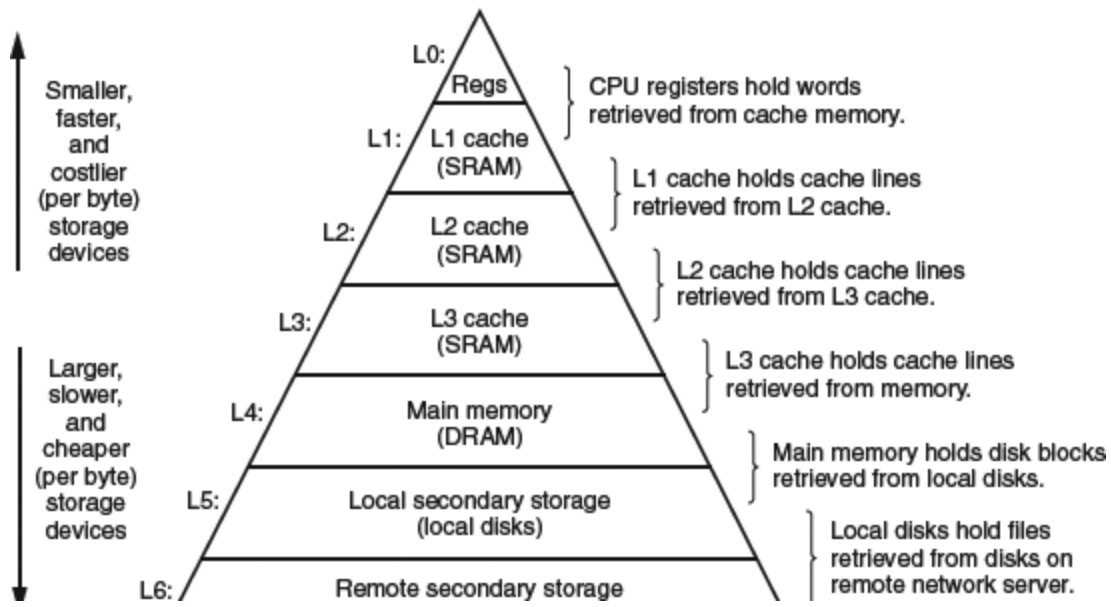



Figure 1.9 An example of a memory hierarchy.

## 1.6 Storage Devices Form a Hierarchy

This notion of inserting a smaller, faster storage device (e.g., cache memory) between the processor and a larger, slower device (e.g., main memory) turns out to be a general idea. In fact, the storage devices in every computer system are organized as a *memory hierarchy* similar to [Figure 1.9](#). As we move from the top of the hierarchy to the bottom, the devices become slower, larger, and less costly per byte. The register file occupies the top level in the hierarchy, which is known as level 0 or L0. We show three levels of caching L1 to L3, occupying memory hierarchy levels 1 to 3. Main memory occupies level 4, and so on.

The main idea of a memory hierarchy is that storage at one level serves as a cache for storage at the next lower level. Thus, the register file is a cache for the L1 cache. Caches L1 and L2 are caches for L2 and L3, respectively. The L3 cache is a cache for the main memory, which is a cache for the disk. On some networked systems with distributed file systems, the local disk serves as a cache for data stored on the disks of other systems.

Just as programmers can exploit knowledge of the different caches to improve performance, programmers can exploit their

understanding of the entire memory hierarchy. **Chapter 6**  will have much more to say about this.

[OceanofPDF.com](http://OceanofPDF.com)

# 1.7 The Operating System Manages the Hardware

Back to our `hello` example. When the shell loaded and ran the `hello` program, and when the `hello` program printed its message, neither program accessed the

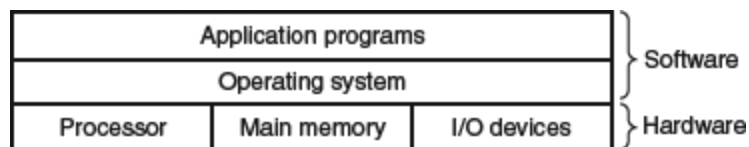


Figure 1.10 Layered view of a computer system.

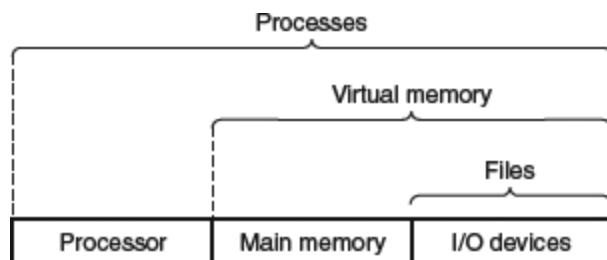



Figure 1.11 Abstractions provided by an operating system.

keyboard, display, disk, or main memory directly. Rather, they relied on the services provided by the *operating system*. We can think of the operating system as a layer of software interposed between the application program and the hardware, as shown in [Figure 1.10](#). All attempts by an application program to manipulate the hardware must go through the operating system.

The operating system has two primary purposes: (1) to protect the hardware from misuse by runaway applications and (2) to provide applications with simple and uniform mechanisms for manipulating complicated and often wildly different low-level hardware devices. The operating system achieves both goals via the fundamental abstractions shown in [Figure 1.11](#) : *processes*, *virtual memory*, and *files*. As this figure suggests, files are abstractions for I/O devices, virtual memory is an abstraction for both the main memory and disk I/O devices, and processes are abstractions for the processor, main memory, and I/O devices. We will discuss each in turn.

## 1.7.1 Processes

When a program such as `hello` runs on a modern system, the operating system provides the illusion that the program is the only one running on the system. The program appears to have exclusive use of both the processor, main memory, and I/O devices. The processor appears to execute the instructions in the program, one after the other, without interruption. And the code and data of the program appear to be the only objects in the system's memory. These illusions are provided by the notion of a process, one of the most important and successful ideas in computer science.

A *process* is the operating system's abstraction for a running program. Multiple processes can run concurrently on the same system, and each process appears to have exclusive use of the hardware. By *concurrently*, we mean that the instructions of one process are interleaved with the instructions of another process. In most systems, there are more processes to run than there are CPUs to run them.

# Aside Unix, Posix, and the Standard

## Unix Specification

The 1960s was an era of huge, complex operating systems, such as IBM's OS/360 and Honeywell's Multics systems. While OS/360 was one of the most successful software projects in history, Multics dragged on for years and never achieved wide-scale use. Bell Laboratories was an original partner in the Multics project but dropped out in 1969 because of concern over the complexity of the project and the lack of progress. In reaction to their unpleasant Multics experience, a group of Bell Labs researchers—Ken Thompson, Dennis Ritchie, Doug McIlroy, and Joe Ossanna—began work in 1969 on a simpler operating system for a Digital Equipment Corporation PDP-7 computer, written entirely in machine language. Many of the ideas in the new system, such as the hierarchical file system and the notion of a shell as a user-level process, were borrowed from Multics but implemented in a smaller, simpler package. In 1970, Brian Kernighan dubbed the new system "Unix" as a pun on the complexity of "Multics." The kernel was rewritten in C in 1973, and Unix was announced to the outside world in 1974 [93].

Because Bell Labs made the source code available to schools with generous terms, Unix developed a large following at universities. The most influential work was done at the University of California at Berkeley in the late 1970s and early 1980s, with Berkeley researchers adding virtual



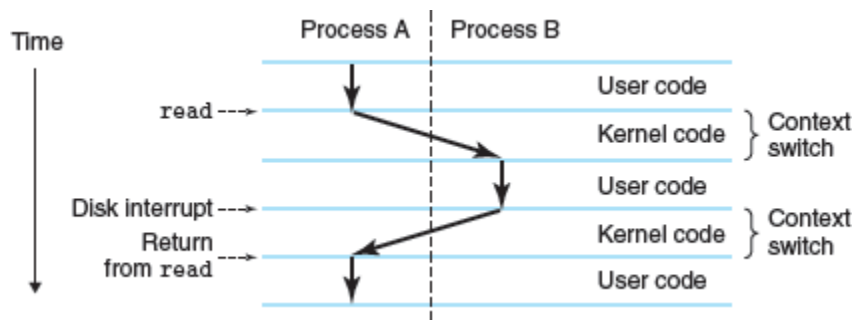
memory and the Internet protocols in a series of releases called Unix 4.xBSD (Berkeley Software Distributimn). Concurrently, Bell Labs was releasing their own versions, which became known as System V Unix. Versions from other vendors, such as the Sun Microsystems Solaris system, were derived from these original BSD and System V versions.

Trouble arose in the mid 1980s as Unix vendors tried to differentiate themselves by adding new and often incompatible features. To combat this trend, IEEE (Institute for Electrical and Electronics Engineers) sponsored an effort to standardize Unix, later dubbed "Posix" by Richard Stallman. The result was a family of standards, known as the Posix standards, that cover such issues as the C language interface for Unix system calls, shell programs and utilities, threads, and network programming. More recently, a separate standardization effort, known as the "Standard Unix Specification," has joined forces with Posix to create a single, unified standard for Unix systems. As a result of these standardization efforts, the differences between Unix versions have largely disappeared.

Traditional systems could only execute one program at a time, while newer *multi-core* processors can execute several programs simultaneously. In either case, a single CPU can appear to execute multiple processes concurrently by having the processor switch among them. The operating system performs this interleaving with a mechanism known as *context switching*. To simplify the rest of this discussion, we consider only a *uniprocessor system* containing a

single CPU. We will return to the discussion of *multiprocessor* systems in [Section 1.9.2](#).

The operating system keeps track of all the state information that the process needs in order to run. This state, which is known as the *context*, includes information such as the current values of the PC, the register file, and the contents of main memory. At any point in time, a uniprocessor system can only execute the code for a single process. When the operating system decides to transfer control from the current process to some new process, it performs a *context switch* by saving the context of the current process, restoring the context of the new process, and



**Figure 1.12** Process context switching.

then passing control to the new process. The new process picks up exactly where it left off. [Figure 1.12](#) shows the basic idea for our example `hello` scenario.

There are two concurrent processes in our example scenario: the shell process and the `hello` process. Initially, the shell process is running alone, waiting for input on the command line. When we ask it

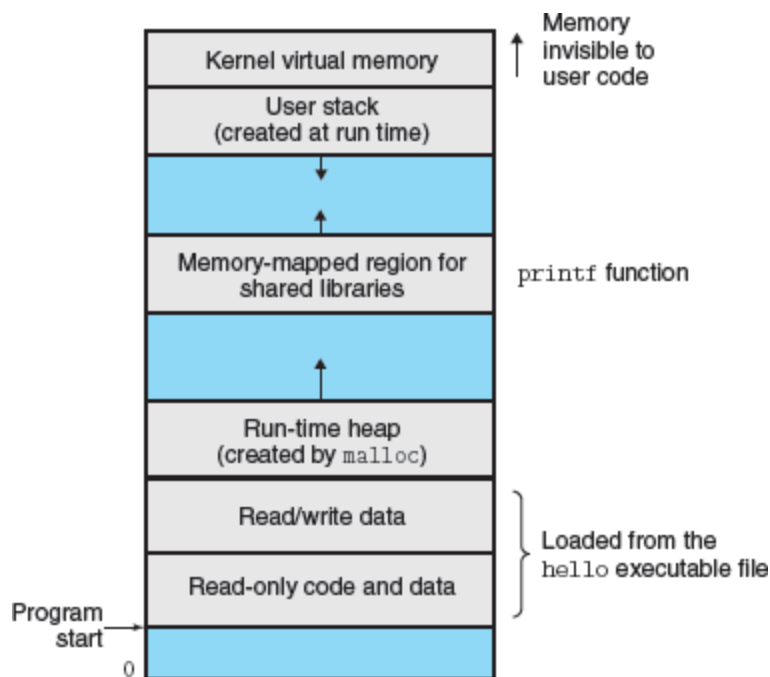
to run the `hello` program, the shell carries out our request by invoking a special function known as a *system call* that passes control to the operating system. The operating system saves the shell's context, creates a new `hello` process and its context, and then passes control to the new `hello` process. After `hello` terminates, the operating system restores the context of the shell process and passes control back to it, where it waits for the next command-line input.

As [Figure 1.12](#) indicates, the transition from one process to another is managed by the operating system *kernel*. The kernel is the portion of the operating system code that is always resident in memory. When an application program requires some action by the operating system, such as to read or write a file, it executes a special *system call* instruction, transferring control to the kernel. The kernel then performs the requested operation and returns back to the application program. Note that the kernel is not a separate process. Instead, it is a collection of code and data structures that the system uses to manage all the processes.

Implementing the process abstraction requires close cooperation between both the low-level hardware and the operating system software. We will explore how this works, and how applications can create and control their own processes, in [Chapter 8](#).



## 1.7.2 Threads

Although we normally think of a process as having a single control flow, in modern systems a process can actually consist of multiple execution units, called *threads*, each running in the context of the process and sharing the same code and global data. Threads are an increasingly important programming model because of the requirement for concurrency in network servers, because it is easier to share data between multiple threads than between multiple processes, and because threads are typically more efficient than processes. Multi-threading is also one way to make programs run faster when multiple processors are available, as we will discuss in



**Figure 1.13** Process virtual address space.

(The regions are not drawn to scale.)




**Section 1.9.2** . You will learn the basic concepts of concurrency, including how to write threaded programs, in **Chapter 12** .

## 1.7.3 Virtual Memory

*Virtual memory* is an abstraction that provides each process with the illusion that it has exclusive use of the main memory. Each process has the same uniform view of memory, which is known as its *virtual address space*. The virtual address space for Linux processes is shown in [Figure 1.13](#). (Other Unix systems use a similar layout.) In Linux, the topmost region of the address space is reserved for code and data in the operating system that is common to all processes. The lower region of the address space holds the code and data defined by the user's process. Note that addresses in the figure increase from the bottom to the top.

The virtual address space seen by each process consists of a number of well-defined areas, each with a specific purpose. You will learn more about these areas later in the book, but it will be helpful to look briefly at each, starting with the lowest addresses and working our way up:

- **Program code and data.** Code begins at the same fixed address for all processes, followed by data locations that correspond to global C variables. The code and data areas are initialized directly from the contents of an executable object file—in our case, the `hello` executable. You will learn more about this part of the address space when we study linking and loading in [Chapter 7](#).

- **Heap.** The code and data areas are followed immediately by the run-time *heap*. Unlike the code and data areas, which are fixed in size once the process begins running, the heap expands and contracts dynamically at run time as a result of calls to C standard library routines such as `malloc` and `free`. We will study heaps in detail when we learn about managing virtual memory in [Chapter 9](#) .
- **Shared libraries.** Near the middle of the address space is an area that holds the code and data for *shared libraries* such as the C standard library and the math library. The notion of a shared library is a powerful but somewhat difficult concept. You will learn how they work when we study dynamic linking in [Chapter 7](#) .
- **Stack.** At the top of the user's virtual address space is the *user stack* that the compiler uses to implement function calls. Like the heap, the user stack expands and contracts dynamically during the execution of the program. In particular, each time we call a function, the stack grows. Each time we return from a function, it contracts. You will learn how the compiler uses the stack in [Chapter 3](#) .
- **Kernel virtual memory.** The top region of the address space is reserved for the kernel. Application programs are not allowed to read or write the contents of this area or to directly call functions defined in the kernel code. Instead, they must invoke the kernel to perform these operations.

For virtual memory to work, a sophisticated interaction is required between the hardware and the operating system software, including a hardware translation of every address generated by the processor.

The basic idea is to store the contents of a process's virtual memory on disk and then use the main memory as a cache for the disk.

[Chapter 9](#) explains how this works and why it is so important to the operation of modern systems.

## 1.7.4 Files

A *file* is a sequence of bytes, nothing more and nothing less. Every I/O device, including disks, keyboards, displays, and even networks, is modeled as a file. All input and output in the system is performed by reading and writing files, using a small set of system calls known as *Unix I/O*.

This simple and elegant notion of a file is nonetheless very powerful because it provides applications with a uniform view of all the varied I/O devices that might be contained in the system. For example, application programmers who manipulate the contents of a disk file are blissfully unaware of the specific disk technology. Further, the same program will run on different systems that use different disk technologies. You will learn about Unix I/O in [Chapter 10](#).



## 1.8 Systems Communicate with Other Systems Using Networks

Up to this point in our tour of systems, we have treated a system as an isolated collection of hardware and software. In practice, modern systems are often linked to other systems by networks. From the point of view of an individual system, the

## Aside The Linux project

In August 1991, a Finnish graduate student named Linus Torvalds modestly announced a new Unix-like operating system kernel:

|  
From: torvalds@klaava.Helsinki.FI (Linus Benedict  
Torvalds)  
Newsgroups: comp.os.minix  
Subject: What would you like to see most in minix?  
Summary: small poll for my new operating system  
Date: 25 Aug 91 20:57:08 GMT

Hello everybody out there using minix -  
I'm doing a (free) operating system (just a hobby, won't  
be big and professional like gnu) for 386(486) AT clones.  
This has been brewing since April, and is starting to get  
ready. I'd like any feedback on things people  
like/dislike in minix, as my OS resembles it somewhat  
(same physical layout of the file-system (due to  
practical reasons) among other things).


I've currently ported bash(1.08) and gcc(1.40), and  
things seem to work. This implies that I'll get something  
practical within a few months, and I'd like to know what  
features most people would want. Any suggestions are  
welcome, but I won't promise I'll implement them :-)

Linus (torvalds@kruuna.helsinki.fi)

As Torvalds indicates, his starting point for creating Linux was Minix, an operating system developed by Andrew S.

Tanenbaum for educational purposes [113].

The rest, as they say, is history. Linux has evolved into a technical and cultural phenomenon. By combining forces with the GNU project, the Linux project has developed a complete, Posix-compliant version of the Unix operating system, including the kernel and all of the supporting infrastructure. Linux is available on a wide array of computers, from handheld devices to mainframe computers. A group at IBM has even ported Linux to a wristwatch!

network can be viewed as just another I/O device, as shown in **Figure 1.14** . When the system copies a sequence of bytes from main memory to the network adapter, the data flow across the network to another machine, instead of, say, to a local disk drive. Similarly, the system can read data sent from other machines and copy these data to its main memory.

With the advent of global networks such as the Internet, copying information from one machine to another has become one of the most important uses of computer systems. For example, applications such as email, instant messaging, the World Wide Web, FTP, and telnet are all based on the ability to copy information over a network.

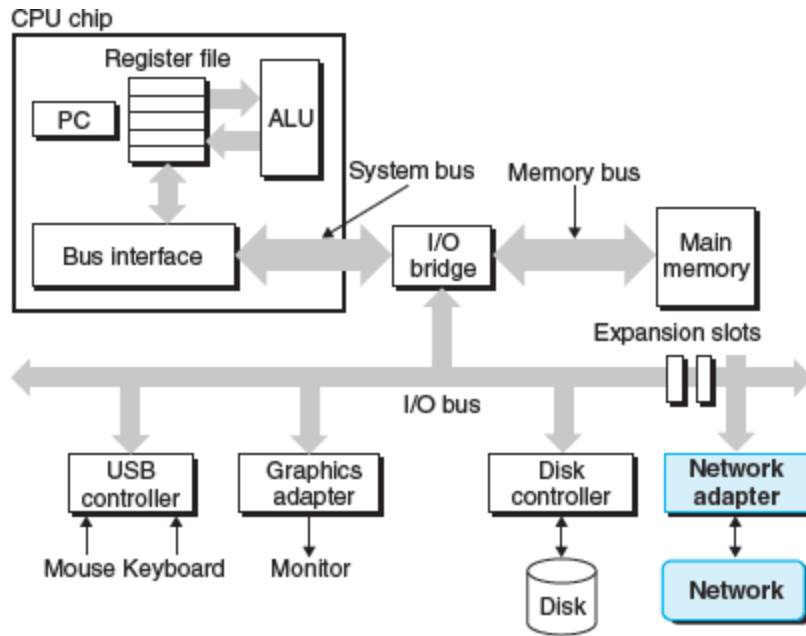


Figure 1.14 A network is another I/O device.

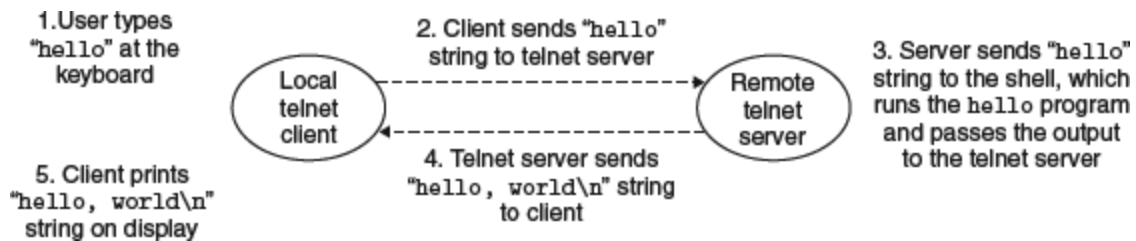


Figure 1.15 Using telnet to run `hello` remotely over a network.

Returning to our `hello` example, we could use the familiar telnet application to run `hello` on a remote machine. Suppose we use a telnet *client* running on our local machine to connect to a telnet *server* on a remote machine. After we log in to the remote machine and run a shell, the remote shell is waiting to receive an input command. From this point, running the `hello` program remotely involves the five basic steps shown in [Figure 1.15](#).

After we type in the `hello` string to the telnet client and hit the enter key, the client sends the string to the telnet server. After the telnet server receives the string from the network, it passes it along to the remote shell program. Next, the remote shell runs the `hello` program and passes the output line back to the telnet server. Finally, the telnet server forwards the output string across the network to the telnet client, which prints the output string on our local terminal.

This type of exchange between clients and servers is typical of all network applications. In [Chapter 11](#) you will learn how to build network applications and apply this knowledge to build a simple Web server.

[OceanofPDF.com](http://OceanofPDF.com)

## 1.9 Important Themes

This concludes our initial whirlwind tour of systems. An important idea to take away from this discussion is that a system is more than just hardware. It is a collection of intertwined hardware and systems software that must cooperate in order to achieve the ultimate goal of running application programs. The rest of this book will fill in some details about the hardware and the software, and it will show how, by knowing these details, you can write programs that are faster, more reliable, and more secure.

To close out this chapter, we highlight several important concepts that cut across all aspects of computer systems. We will discuss the importance of these concepts at multiple places within the book.

## 1.9.1 Amdahl's Law

Gene Amdahl, one of the early pioneers in computing, made a simple but insightful observation about the effectiveness of improving the performance of one part of a system. This observation has come to be known as *Amdahl's law*. The main idea is that when we speed up one part of a system, the effect on the overall system performance depends on both how significant this part was and how much it sped up. Consider a system in which executing some application requires time  $T_{old}$ . Suppose some part of the system requires a fraction  $\alpha$  of this time, and that we improve its performance by a factor of  $k$ . That is, the component originally required time  $\alpha T_{old}$ , and it now requires time  $(\alpha T_{old})/k$ . The overall execution time would thus be

$$\begin{aligned} T_{new} &= (1 - \alpha)T_{old} + (\alpha T_{old})/k \\ &= T_{old}[(1 - \alpha) + \alpha/k] \end{aligned}$$

From this, we can compute the speedup  $S = T_{old}/T_{new}$  as

$$S = \frac{1}{(1 - \alpha) + \alpha/k} \tag{1.1}$$

As an example, consider the case where a part of the system that initially consumed 60% of the time ( $\alpha = 0.6$ ) is sped up by a factor of 3 ( $k = 3$ ). Then we get a speedup of  $1/[0.4 + 0.6/3] = 1.67\times$ . Even though we made a substantial improvement to a major part of the



system, our net speedup was significantly less than the speedup for the one part. This is the major insight of Amdahl's law—to significantly speed up the entire system, we must improve the speed of a very large fraction of the overall system.

## *Practice Problem 1.1 (solution page **28**)*

Suppose you work as a truck driver, and you have been hired to carry a load of potatoes from Boise, Idaho, to Minneapolis, Minnesota, a total distance of 2,500 kilometers. You estimate you can average 100 km/hr driving within the speed limits, requiring a total of 25 hours for the trip.

# Aside Expressing relative performance

The best way to express a performance improvement is as a ratio of the form  $T_{\text{old}}/T_{\text{new}}$ , where  $T_{\text{old}}$  is the time required for the original version and  $T_{\text{new}}$  is the time required by the modified version. This will be a number greater than 1.0 if any real improvement occurred. We use the suffix 'x' to indicate such a ratio, where the factor "2.2x" is expressed verbally as "2.2 times."

The more traditional way of expressing relative change as a percentage works well when the change is small, but its definition is ambiguous. Should it be  $100 \cdot (T_{\text{old}} - T_{\text{new}})/T_{\text{new}}$ , or possibly  $100 \cdot (T_{\text{old}} - T_{\text{new}})/T_{\text{old}}$ , or something else? In addition, it is less instructive for large changes. Saying that "performance improved by 120%" is more difficult to comprehend than simply saying that the performance improved by 2.2x.

- A. You hear on the news that Montana has just abolished its speed limit, which constitutes 1,500 km of the trip. Your truck can travel at 150 km/hr. What will be your speedup for the trip?
- B. You can buy a new turbocharger for your truck at [www.fasttrucks.com](http://www.fasttrucks.com). They stock a variety of models, but the faster you want to go, the more it will cost. How fast must you

travel through Montana to get an overall speedup for your trip of 1.67×?

## *Practice Problem 1.2 (solution page 28)*

The marketing department at your company has promised your customers that the next software release will show a 2× performance improvement. You have been assigned the task of delivering on that promise. You have determined that only 80% of the system can be improved. How much (i.e., what value of  $k$ ) would you need to improve this part to meet the overall performance target?

One interesting special case of Amdahl's law is to consider the effect of setting  $k$  to  $\infty$ . That is, we are able to take some part of the system and speed it up to the point at which it takes a negligible amount of time. We then get

$$S_{\infty} = \frac{1}{(1 - \alpha)} \quad (1.2)$$

So, for example, if we can speed up 60% of the system to the point where it requires close to no time, our net speedup will still only be  $1/0.4 = 2.5\times$ .

Amdahl's law describes a general principle for improving any process. In addition to its application to speeding up computer systems, it can guide a company trying to reduce the cost of


manufacturing razor blades, or a student trying to improve his or her grade point average. Perhaps it is most meaningful in the world of computers, where we routinely improve performance by factors of 2 or more. Such high factors can only be achieved by optimizing large parts of a system.

## 1.9.2 Concurrency and Parallelism

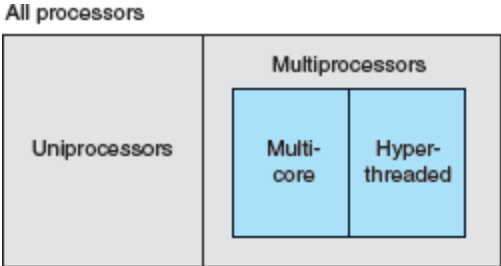
Throughout the history of digital computers, two demands have been constant forces in driving improvements: we want them to do more, and we want them to run faster. Both of these factors improve when the processor does more things at once. We use the term *concurrency* to refer to the general concept of a system with multiple, simultaneous activities, and the term *parallelism* to refer to the use of concurrency to make a system run faster. Parallelism can be exploited at multiple levels of abstraction in a computer system. We highlight three levels here, working from the highest to the lowest level in the system hierarchy.

## *Thread-Level Concurrency*

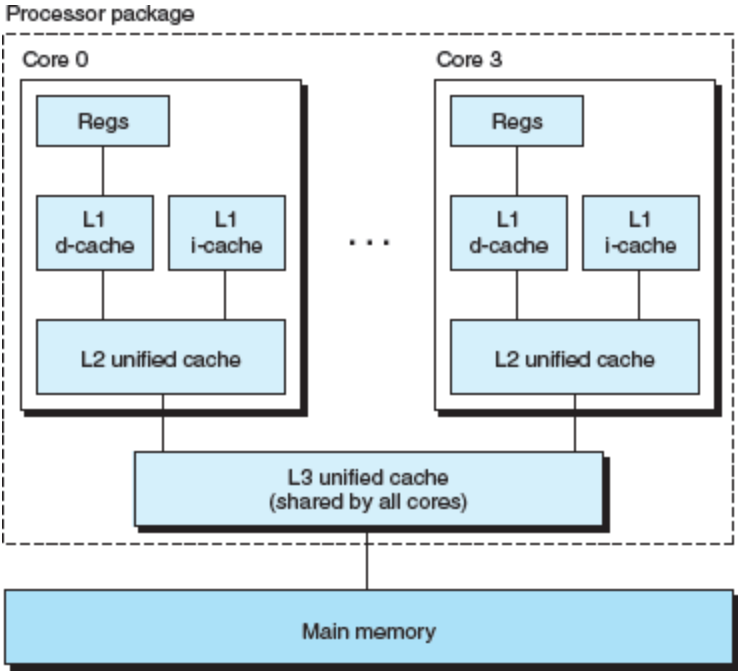
Building on the process abstraction, we are able to devise systems where multiple programs execute at the same time, leading to *concurrency*. With threads, we can even have multiple control flows executing within a single process. Support for concurrent execution has been found in computer systems since the advent of time-sharing in the early 1960s. Traditionally, this concurrent execution was only *simulated*, by having a single computer rapidly switch among its executing processes, much as a juggler keeps multiple balls flying through the air. This form of concurrency allows multiple users to interact with a system at the same time, such as when many people want to get pages from a single Web server. It also allows a single user to engage in multiple tasks concurrently, such as having a Web browser in one window, a word processor in another, and streaming music playing at the same time. Until recently, most actual computing was done by a single processor, even if that processor had to switch among multiple tasks. This configuration is known as a *uniprocessor system*.

When we construct a system consisting of multiple processors all under the control of a single operating system kernel, we have a *multiprocessor system*. Such systems have been available for large-scale computing since the 1980s, but they have more recently become commonplace with the advent of *multi-core* processors and *hyperthreading*. **Figure 1.16**  shows a taxonomy of these different processor types.

Multi-core processors have several CPUs (referred to as "cores") integrated onto a single integrated-circuit chip. [Figure 1.17](#) illustrates the organization of a



**Figure 1.16 Categorizing different processor configurations.** Multiprocessors are becoming prevalent with the advent of multi-core processors and hyperthreading.




**Figure 1.17 Multi-core processor organization.** Four processor cores are integrated onto a single chip.

typical multi-core processor, where the chip has four CPU cores, each with its own L1 and L2 caches, and with each L1 cache split into two parts—one to hold recently fetched instructions and one to hold data. The cores share higher levels of cache as well as the interface to main memory. Industry experts predict that they will be able to have dozens, and ultimately hundreds, of cores on a single chip.

Hyperthreading, sometimes called *simultaneous multi-threading*, is a technique that allows a single CPU to execute multiple flows of control. It involves having multiple copies of some of the CPU hardware, such as program counters and register files, while having only single copies of other parts of the hardware, such as the units that perform floating-point arithmetic. Whereas a conventional processor requires around 20,000 clock cycles to shift between different threads, a hyper threaded processor decides which of its threads to execute on a cycle-by-cycle basis. It enables the CPU to take better advantage of its processing resources. For example, if one thread must wait for some data to be loaded into a cache, the CPU can proceed with the execution of a different thread. As an example, the Intel Core i7 processor can have each core executing two threads, and so a four-core system can actually execute eight threads in parallel.

The use of multiprocessing can improve system performance in two ways. First, it reduces the need to simulate concurrency when performing multiple tasks. As mentioned, even a personal computer being used by a single person is expected to perform many activities



concurrently. Second, it can run a single application program faster, but only if that program is expressed in terms of multiple threads that can effectively execute in parallel. Thus, although the principles of concurrency have been formulated and studied for over 50 years, the advent of multi-core and hyperthreaded systems has greatly increased the desire to find ways to write application programs that can exploit the thread-level parallelism available with the hardware. **Chapter 12**  will look much more deeply into concurrency and its use to provide a sharing of processing resources and to enable more parallelism in program execution.


# *Instruction-Level Parallelism*

At a much lower level of abstraction, modern processors can execute multiple instructions at one time, a property known as *instruction-level parallelism*. For example, early microprocessors, such as the 1978-vintage Intel 8086, required multiple (typically 3-10) clock cycles to execute a single instruction. More recent processors can sustain execution rates of 2-4 instructions per clock cycle. Any given instruction requires much longer from start to finish, perhaps 20 cycles or more, but the processor uses a number of clever tricks to process as many as 100 instructions at a time. In [Chapter 4](#), we will explore the use of *pipelining*, where the actions required to execute an instruction are partitioned into different steps and the processor hardware is organized as a series of stages, each performing one of these steps. The stages can operate in parallel, working on different parts of different instructions. We will see that a fairly simple hardware design can sustain an execution rate close to 1 instruction per clock cycle.

Processors that can sustain execution rates faster than 1 instruction per cycle are known as *superscalar* processors. Most modern processors support superscalar operation. In [Chapter 5](#), we will describe a high-level model of such processors. We will see that application programmers can use this model to understand the performance of their programs. They can then write programs such that the generated code achieves higher degrees of instruction-level parallelism and therefore runs faster.

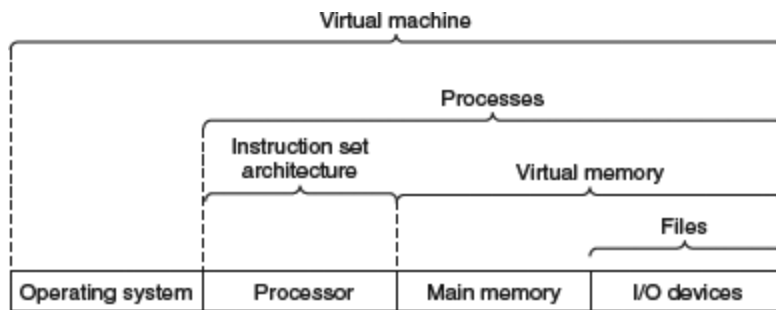
# *Single-Instruction, Multiple-Data (SIMD) Parallelism*

At the lowest level, many modern processors have special hardware that allows a single instruction to cause multiple operations to be performed in parallel, a mode known as *single-instruction, multiple-data*(SIMD) parallelism. For example, recent generations of Intel and AMD processors have instructions that can add 8 pairs of single-precision floating-point numbers (C data type `float`) in parallel.

These SIMD instructions are provided mostly to speed up applications that process image, sound, and video data. Although some compilers attempt to automatically extract SIMD parallelism from C programs, a more reliable method is to write programs using special *vector* data types supported in compilers such as GCC. We describe this style of programming in Web Aside `OPT:SIMD`, as a supplement to the more general presentation on program optimization found in [Chapter 5](#) .

# 1.9.3 The Importance of Abstractions in Computer Systems

The use of *abstractions* is one of the most important concepts in computer science. For example, one aspect of good programming practice is to formulate a simple application program interface (API) for a set of functions that allow programmers to use the code without having to delve into its inner workings. Different programming



**Figure 1.18 Some abstractions provided by a computer system.** A major theme in computer systems is to provide abstract representations at different levels to hide the complexity of the actual implementations.

languages provide different forms and levels of support for abstraction, such as Java class declarations and C function prototypes.

We have already been introduced to several of the abstractions seen in computer systems, as indicated in [Figure 1.18](#). On the processor side, the *instruction set architecture* provides an abstraction of the actual processor hardware. With this abstraction, a machine-code program behaves as if it were executed on a processor that performs just one instruction at a time. The underlying hardware is far more elaborate, executing multiple instructions in parallel, but always in a way that is consistent with the simple, sequential model. By keeping the same execution model, different processor implementations can execute the same machine code while offering a range of cost and performance.

On the operating system side, we have introduced three abstractions: *files* as an abstraction of I/O devices, *virtual memory* as an abstraction of program memory, and *processes* as an abstraction of a running program. To these abstractions we add a new one: the *virtual machine*, providing an abstraction of the entire computer, including the operating system, the processor, and the programs. The idea of a virtual machine was introduced by IBM in the 1960s, but it has become more prominent recently as a way to manage computers that must be able to run programs designed for multiple operating systems (such as Microsoft Windows, Mac OS X, and Linux) or different versions of the same operating system.

We will return to these abstractions in subsequent sections of the book.

## 1.10 Summary

A computer system consists of hardware and systems software that cooperate to run application programs. Information inside the computer is represented as groups of bits that are interpreted in different ways, depending on the context. Programs are translated by other programs into different forms, beginning as ASCII text and then translated by compilers and linkers into binary executable files.

Processors read and interpret binary instructions that are stored in main memory. Since computers spend most of their time copying data between memory, I/O devices, and the CPU registers, the storage devices in a system are arranged in a hierarchy, with the CPU registers at the top, followed by multiple levels of hardware cache memories, DRAM main memory, and disk storage. Storage devices that are higher in the hierarchy are faster and more costly per bit than those lower in the hierarchy. Storage devices that are higher in the hierarchy serve as caches for devices that are lower in the hierarchy. Programmers can optimize the performance of their C programs by understanding and exploiting the memory hierarchy.

The operating system kernel serves as an intermediary between the application and the hardware. It provides three fundamental abstractions: (1) Files are abstractions for I/O devices. (2) Virtual memory is an abstraction for both main memory and disks. (3)

Processes are abstractions for the processor, main memory, and I/O devices.

Finally, networks provide ways for computer systems to communicate with one another. From the viewpoint of a particular system, the network is just another I/O device.

[OceanofPDF.com](http://OceanofPDF.com)

# Bibliographic Notes

Ritchie has written interesting firsthand accounts of the early days of C and `Unix` [91, 92]. Ritchie and Thompson presented the first published account of `Unix` [93]. Silberschatz, Galvin, and Gagne [102] provide a comprehensive history of the different flavors of Unix. The GNU ([www.gnu.org](http://www.gnu.org)) and Linux ([www.linux.org](http://www.linux.org)) Web pages have loads of current and historical information. The Posix standards are available online at ([www.unix.org](http://www.unix.org)).

[OceanofPDF.com](http://OceanofPDF.com)



# Solutions to Practice Problems

## Solution to Problem 1.1 (page 22)

This problem illustrates that Amdahl's law applies to more than just computer systems.

- A. In terms of [Equation 1.1 !\[\]\(38441ceaa711016e0bf2ad46ad394ff4\_img.jpg\)](#), we have  $\alpha = 0.6$  and  $k = 1.5$ . More directly, traveling the 1,500 kilometers through Montana will require 10 hours, and the rest of the trip also requires 10 hours. This will give a speedup of  $25/(10 + 10) = 1.25\times$ .
- B. In terms of [Equation 1.1 !\[\]\(6e027340d4263908f264926b1ad81c5e\_img.jpg\)](#), we have  $\alpha = 0.6$ , and we require  $S = 1.67$ , from which we can solve for  $k$ . More directly, to speed up the trip by  $1.67\times$ , we must decrease the overall time to 15 hours. The parts outside of Montana will still require 10 hours, so we must drive through Montana in 5 hours. This requires traveling at 300 km/hr, which is pretty fast for a truck!

# Solution to Problem 1.2 (page 23)

Amdahl's law is best understood by working through some examples. This one requires you to look at [Equation 1.1](#) from an unusual perspective.

This problem is a simple application of the equation. You are given  $S = 2$  and  $\alpha = 0.8$ , and you must then solve for  $k$ :

$$\begin{aligned}2 &= \frac{1}{(1-0.8)+0.8/k} \\0.4 + 1.6/k &= 1.0 \\k &= 2.67\end{aligned}$$

[OceanofPDF.com](http://OceanofPDF.com)

# Part I Program Structure and Execution

Our exploration of computer systems starts by studying the computer itself, comprising a processor and a memory subsystem. At the core, we require ways to represent basic data types, such as approximations to integer and real arithmetic. From there, we can consider how machine-level instructions manipulate data and how a compiler translates C programs into these instructions. Next, we study several methods of implementing a processor to gain a better understanding of how hardware resources are used to execute instructions. Once we understand compilers and machine-level code, we can examine how to maximize program performance by writing C programs that, when compiled, achieve the maximum possible performance. We conclude with the design of the memory subsystem, one of the most complex components of a modern computer system.

This part of the book will give you a deep understanding of how application programs are represented and executed. You will gain skills that help you write programs that are secure, reliable, and make the best use of the computing resources.

---

# Chapter 2 Representing and Manipulating Information

---

**2.1 Information Storage 34** 

**2.2 Integer Representations 59** 

**2.3 Integer Arithmetic 84** 

**2.4 Floating Point 108** 

**2.5 Summary 126** 

**Bibliographic Notes 127** 

**Homework Problems 128** 

**Solutions to Practice Problems 143** 

*Modern computers store and process information represented as two-valued signals. These lowly binary digits, or bits, form the basis of the digital revolution. The familiar decimal, or base-10, representation has been in use for over 1,000 years, having been developed in India, improved by Arab mathematicians in the 12th century, and brought to the West in the 13th century by the Italian mathematician Leonardo Pisano (ca. 1170 to ca. 1250), better known as Fibonacci. Using decimal notation is natural for 10-fingered humans, but binary values work better when building machines that store and process information. Two-valued signals can readily be represented, stored, and transmitted—for example, as the presence or absence of a hole in a punched card, as a high or low voltage on a wire, or as a magnetic domain oriented clockwise or counterclockwise. The electronic circuitry for storing and performing computations on two-valued signals is very simple and reliable, enabling manufacturers to integrate millions, or even billions, of such circuits on a single silicon chip.*

*In isolation, a single bit is not very useful. When we group bits together and apply some interpretation that gives meaning to the different*

*possible bit patterns, however, we can represent the elements of any finite set. For example, using a binary number system, we can use groups of bits to encode nonnegative numbers. By using a standard character code, we can encode the letters and symbols in a document. We cover both of these encodings in this chapter, as well as encodings to represent negative numbers and to approximate real numbers.*

*We consider the three most important representations of numbers. Unsigned encodings are based on traditional binary notation, representing numbers greater than or equal to 0. Two's-complement encodings are the most common way to represent signed integers, that is, numbers that may be either positive or negative. Floating-point encodings are a base-2 version of scientific notation for representing real numbers. Computers implement arithmetic operations, such as addition and multiplication, with these different representations, similar to the corresponding operations on integers and real numbers.*

*Computer representations use a limited number of bits to encode a number, and hence some operations can overflow when the results are too large to be represented. This can lead to some surprising results. For example, on most of today's computers (those using a 32-bit representation for data type int), computing the expression*

```
200 * 300 * 400 * 500
```

*yields –884,901,888. This runs counter to the properties of integer arithmetic—computing the product of a set of positive numbers has yielded a negative result.*

*On the other hand, integer computer arithmetic satisfies many of the familiar properties of true integer arithmetic. For example, multiplication is associative and commutative, so that computing any of the following C expressions yields –884,901,888:*



```
(500 * 400) * (300 * 200)
```

```
((500 * 400) * 300) * 200
```

```
((200 * 500) * 300) * 400
```

```
400 * (200 * (300 * 500))
```

*The computer might not generate the expected result, but at least it is consistent!*

*Floating-point arithmetic has altogether different mathematical properties. The product of a set of positive numbers will always be positive, although overflow will yield the special value  $+\infty$ . Floating-point arithmetic is not associative due to the finite precision of the representation. For example, the C expression `(3.14+1e20)-1e20` will evaluate to 0.0 on most machines, while `3.14+(1e20-1e20)` will evaluate to 3.14. The different mathematical properties of integer versus floating-point arithmetic stem from the difference in how they handle the finiteness of their representations—integer representations can encode a comparatively small range of values, but do so precisely, while floating-point*

*representations can encode a wide range of values, but only approximately.*

*By studying the actual number representations, we can understand the ranges of values that can be represented and the properties of the different arithmetic operations. This understanding is critical to writing programs that work correctly over the full range of numeric values and that are portable across different combinations of machine, operating system, and compiler. As we will describe, a number of computer security vulnerabilities have arisen due to some of the subtleties of computer arithmetic. Whereas in an earlier era program bugs would only inconvenience people when they happened to be triggered, there are now legions of hackers who try to exploit any bug they can find to obtain unauthorized access to other people's systems. This puts a higher level of obligation on programmers to understand how their programs work and how they can be made to behave in undesirable ways.*

*Computers use several different binary representations to encode numeric values. You will need to be familiar with these*

representations as you progress into machine-level programming in [Chapter 3](#). We describe these encodings in this chapter and show you how to reason about number representations.

We derive several ways to perform arithmetic operations by directly manipulating the bit-level representations of numbers. Understanding these techniques will be important for understanding the machine-level code generated by compilers in their attempt to optimize the performance of arithmetic expression evaluation.

Our treatment of this material is based on a core set of mathematical principles. We start with the basic definitions of the encodings and then derive such properties as the range of representable numbers, their bit-level representations, and the properties of the arithmetic operations. We believe it is important for you to examine the material from this abstract viewpoint, because programmers need to have a clear understanding of how computer arithmetic relates to the more familiar integer and real arithmetic.

*The C++ programming language is built upon C, using the exact same numeric representations and operations. Everything said in this chapter about C also holds for C++. The Java language definition, on the other hand, created a new set of standards for numeric representations and operations. Whereas the C standards are designed to allow a wide range of implementations, the Java standard is quite specific on the formats and encodings of data. We highlight the representations and operations supported by Java at several places in the chapter.*

# *Aside How to read this chapter*

*In this chapter, we examine the fundamental properties of how numbers and other forms of data are represented on a computer and the properties of the operations that computers perform on these data. This requires us to delve into the language of mathematics, writing formulas and equations and showing derivations of important properties.*

*To help you navigate this exposition, we have structured the presentation to first state a property as a principle in mathematical notation. We then illustrate this principle with examples and an informal discussion. We recommend that you go back and forth between the statement of the principle and the examples and discussion until you have a solid intuition for what is being said and what is important about the property. For more complex properties, we also provide a derivation, structured much like a mathematical proof. You should try to*

*understand these derivations eventually, but you could skip over them on first reading.*

*We also encourage you to work on the practice problems as you proceed through the presentation. The practice problems engage you in active learning, helping you put thoughts into action. With these as background, you will find it much easier to go back and follow the derivations. Be assured, as well, that the mathematical skills required to understand this material are within reach of someone with a good grasp of high school algebra.*

[OceanofPDF.com](http://OceanofPDF.com)

## 2.1 Information Storage

Rather than accessing individual bits in memory, most computers use blocks of 8 bits, or *bytes*, as the smallest addressable unit of memory. A machine-level program views memory as a very large array of bytes, referred to as *virtual memory*. Every byte of memory is identified by a unique number, known as its *address*, and the set of all possible addresses is known as the *virtual address space*. As indicated by its name, this virtual address space is just a conceptual image presented to the machine-level program. The actual implementation (presented in [Chapter 9](#)) uses a combination of dynamic random access memory (DRAM), flash memory, disk storage, special hardware, and operating system software to provide the program with what appears to be a monolithic byte array.

In subsequent chapters, we will cover how the compiler and run-time system partitions this memory space into more manageable units to store the different *program objects*, that is, program data, instructions, and control information. Various mechanisms are used to allocate and manage the storage for different parts of the program. This management is all performed within the virtual address space. For example, the value of a pointer in C—whether it points to an integer, a structure, or some other program object—is the virtual address of the first byte of some block of storage. The C compiler also associates *type* information with each pointer, so that it can generate different machine-level code to access the value stored

at the location designated by the pointer depending on the type of that value. Although the C compiler maintains this type information, the actual machine-level program it generates has no information about data types. It simply treats each program object as a block of bytes and the program itself as a sequence of bytes.



# Aside The evolution of the C programming language

As was described in an aside on page 4, the C programming language was first developed by Dennis Ritchie of Bell Laboratories for use with the Unix operating system (also developed at Bell Labs). At the time, most system programs, such as operating systems, had to be written largely in assembly code in order to have access to the low-level representations of different data types. For example, it was not feasible to write a memory allocator, such as is provided by the `malloc` library function, in other high-level languages of that era.

The original Bell Labs version of C was documented in the first edition of the book by Brian Kernighan and Dennis Ritchie [60]. Over time, C has evolved through the efforts of several standardization groups. The first major revision of the original Bell Labs C led to the ANSI C standard in 1989, by a group working under the auspices of the American National Standards Institute. ANSI C was a major departure from Bell Labs C, especially in the way functions are declared. ANSI C is described in the second edition of Kernighan and Ritchie's book [61], which is still considered one of the best references on C.

The International Standards Organization took over responsibility for standardizing the C language, adopting a

version that was substantially the same as ANSI C in 1990 and hence is referred to as “ISO C90.”

This same organization sponsored an updating of the language in 1999, yielding “ISO C99.” Among other things, this version introduced some new data types and provided support for text strings requiring characters not found in the English language. A more recent standard was approved in 2011, and hence is named “ISO C11,” again adding more data types and features. Most of these recent additions have been *backward compatible*, meaning that programs written according to the earlier standard (at least as far back as ISO C90) will have the same behavior when compiled according to the newer standards.

The GNU Compiler Collection (`gcc`) can compile programs according to the conventions of several different versions of the C language, based on different command-line options, as shown in [Figure 2.1](#). For example, to compile program `prog.c` according to ISO C11, we could give the command line

```
linux> gcc -std=c11 prog.c
```

The options `-ansi` and `-std=c89` have identical effect—the code is compiled according to the ANSI or ISO C90 standard. (C90 is sometimes referred to as “C89,” since its

standardization effort began in 1989.) The option `-std=c99` causes the compiler to follow the ISO C99 convention.

As of the writing of this book, when no option is specified, the program will be compiled according to a version of C based on ISO C90, but including some features of C99, some of C11, some of C++, and others specific to `gcc`. The GNU project is developing a version that combines ISO C11, plus other features, that can be specified with command-line option `-std=gnu11`. (Currently, this implementation is incomplete.) This will become the default version.

**Figure 2.1** Specifying different versions of C to `gcc`.

## New to C? The role of pointers in C

Pointers are a central feature of C. They provide the mechanism for referencing elements of data structures, including arrays. Just like a variable, a pointer has two aspects: its *value* and its *type*. The value indicates the location of some object, while its type indicates what kind of object (e.g., integer or floating-point number) is stored at that location.

Truly understanding pointers requires examining their representation and implementation at the machine level. This will be a major focus in [Chapter 3](#), culminating in an in-depth presentation in [Section 3.10.1](#).

## 2.1.1 Hexadecimal Notation

A single byte consists of 8 bits. In binary notation, its value ranges from  $00000000_2$  to  $11111111_2$ . When viewed as a decimal integer, its value ranges from  $0_{10}$  to  $255_{10}$ . Neither notation is very convenient for describing bit patterns. Binary notation is too verbose, while with decimal notation it is tedious to convert to and from bit patterns. Instead, we write bit patterns as base-16, or *hexadecimal* numbers. Hexadecimal (or simply “hex”) uses digits ‘0’ through ‘9’ along with characters ‘A’ through ‘F’ to represent 16 possible values. [Figure 2.2](#) shows the decimal and binary values associated with the 16 hexadecimal digits. Written in hexadecimal, the value of a single byte can range from  $00_{16}$  to  $FF_{16}$ .

In C, numeric constants starting with `0x` or `0X` are interpreted as being in hexadecimal. The characters ‘A’ through ‘F’ may be written in either upper- or lowercase. For example, we could write the number  $FA1D37B_{16}$  as `0xFA1D37B`, as `0xfa1d37b`, or even mixing upper- and lower case (e.g., `0xFa1D37b`). We will use the C notation for representing hexadecimal values in this book.

A common task in working with machine-level programs is to manually convert between decimal, binary, and hexadecimal representations of bit patterns. Converting between binary and hexadecimal is straightforward, since it can be performed one hexadecimal digit at a time. Digits can be converted by referring to a chart such as that shown in [Figure 2.2](#). One simple trick for doing

the conversion in your head is to memorize the decimal equivalents of hex digits **A**, **C**, and **F**.

### Figure 2.2 Hexadecimal notation.

Each hex digit encodes one of 16 values.

The hex values **B**, **D**, and **E** can be translated to decimal by computing their values relative to the first three.

For example, suppose you are given the number **0x173A4C**. You can convert this to binary format by expanding each hexadecimal digit, as follows:

This gives the binary representation 000101110011101001001100.

Conversely, given a binary number 1111001010110110110011, you convert it to hexadecimal by first splitting it into groups of 4 bits each. Note, however, that if the total number of bits is not a multiple of 4, you should make the *leftmost* group be the one with fewer than 4 bits, effectively padding the number with leading zeros. Then you translate each group of bits into the corresponding hexadecimal digit:

## Practice Problem 2.1 (solution page 143)

Perform the following number conversions:

- A. `0x39A7F8` to binary
- B. binary 1100100101111011 to hexadecimal
- C. `0xD5E4C` to binary
- D. binary 1001101110011110110101 to hexadecimal

When a value  $x$  is a power of 2, that is,  $x = 2^n$  for some nonnegative integer  $n$ , we can readily write  $x$  in hexadecimal form by remembering that the binary representation of  $x$  is simply 1 followed by  $n$  zeros. The hexadecimal digit 0 represents 4 binary zeros. So, for  $n$  written in the form  $i + 4j$ , where  $0 \leq i \leq 3$ , we can write  $x$  with a leading hex digit of 1 ( $i = 0$ ), 2 ( $i = 1$ ), 4 ( $i = 2$ ), or 8 ( $i = 3$ ), followed by  $j$  hexadecimal `0s`. As an example, for  $x = 2,048 = 2^{11}$ , we have  $n = 11 = 3 + 4 \cdot 2$ , giving hexadecimal representation `0x800`.

## Practice Problem 2.2 (solution page 143)

Fill in the blank entries in the following table, giving the decimal and hexadecimal representations of different powers of 2:

Converting between decimal and hexadecimal representations requires using multiplication or division to handle the general case. To convert a decimal number  $x$  to hexadecimal, we can repeatedly divide  $x$  by 16, giving a quotient  $q$  and a remainder  $r$ , such that  $x = q \cdot 16 + r$ . We then use the hexadecimal digit representing  $r$  as the least significant digit and generate the remaining digits by repeating the process on  $q$ . As an example, consider the conversion of decimal 314,156:314,156

$$314,156:314,156 = 19,634 \cdot 16 + 12 \quad (\text{C})$$

$$19,634 = 1,227 \cdot 16 + 2 \quad (\text{2})$$

$$1,227 = 76 \cdot 16 + 11 \quad (\text{B})$$

$$76 = 4 \cdot 16 + 12 \quad (\text{C})$$

$$4 = 0 \cdot 16 + 4 \quad (\text{4})$$

From this we can read off the hexadecimal representation as

`0x4CB2C`.

Conversely, to convert a hexadecimal number to decimal, we can multiply each of the hexadecimal digits by the appropriate power of 16. For example, given the number `0x7AF`, we compute its decimal equivalent as  $7 \cdot 16^2 + 10 \cdot 16 + 15 = 7 \cdot 256 + 10 \cdot 16 + 15 = 1,792 + 160 + 15 = 1,967$ .

## Practice Problem 2.3 (solution page [144](#))

A single byte can be represented by 2 hexadecimal digits. Fill in the missing entries in the following table, giving the decimal, binary, and hexadecimal values of different byte patterns:

### Aside Converting between decimal and hexadecimal

For converting larger values between decimal and hexadecimal, it is best to let a computer or calculator do the work. There are numerous tools that can do this. One simple way is to use any of the standard search engines, with queries such as

Convert `0xabcd` to decimal

or

123 in hex



## Practice Problem 2.4 (solution page [144](#))

Without converting the numbers to decimal or binary, try to solve the following arithmetic problems, giving the answers in hexadecimal. *Hint:* Just modify the methods you use for performing decimal addition and subtraction to use base 16.

A.  $0x503c + 0x8 =$  \_\_\_\_\_

B.  $0x503c - 0x40 =$  \_\_\_\_\_

C.  $0x503c + 64 =$  \_\_\_\_\_

D.  $0x50ea - 0x503c =$  \_\_\_\_\_

## 2.1.2 Data Sizes

Every computer has a *word size*, indicating the nominal size of pointer data. Since a virtual address is encoded by such a word, the most important system parameter determined by the word size is the maximum size of the virtual address space. That is, for a machine with a  $w$ -bit word size, the virtual addresses can range from 0 to  $2^w - 1$ , giving the program access to at most  $2^w$  bytes.

In recent years, there has been a widespread shift from machines with 32-bit word sizes to those with word sizes of 64 bits. This occurred first for high-end machines designed for large-scale scientific and database applications, followed by desktop and laptop machines, and most recently for the processors found in smartphones. A 32-bit word size limits the virtual address space to 4 gigabytes (written 4 GB), that is, just over  $4 \times 10^9$  bytes. Scaling up to a 64-bit word size leads to a virtual address space of 16 *exabytes*, or around  $1.84 \times 10^{19}$  bytes.

Most 64-bit machines can also run programs compiled for use on 32-bit machines, a form of backward compatibility. So, for example, when a program `prog.c` is compiled with the directive

```
linux> gcc -m32 prog.c
```

then this program will run correctly on either a 32-bit or a 64-bit machine. On the other hand, a program compiled with the directive

```
linux> gcc -m64 prog.c
```

will only run on a 64-bit machine. We will therefore refer to programs as being either “32-bit programs” or “64-bit programs,” since the distinction lies in how a program is compiled, rather than the type of machine on which it runs.

Computers and compilers support multiple data formats using different ways to encode data, such as integers and floating point, as well as different lengths. For example, many machines have instructions for manipulating single bytes, as well as integers represented as 2-, 4-, and 8-byte quantities. They also support floating-point numbers represented as 4- and 8-byte quantities.

The C language supports multiple data formats for both integer and floating-point data. [Figure 2.3](#) shows the number of bytes typically allocated for different C data types. (We discuss the relation between what is guaranteed by the C standard versus what is typical in [Section 2.2](#).) The exact numbers of bytes for some data types depends on how the program is compiled. We show sizes for typical 32-bit and 64-bit programs. Integer data can be either *signed*, able to represent negative, zero, and positive values, or *unsigned*, only allowing nonnegative values. Data type `char` represents a single

byte. Although the name `char` derives from the fact that it is used to store a single character in a text string, it can also be used to store integer values. Data types `short`, `int`, and `long` are intended to provide a range of

### Figure 2.3 Typical sizes (in bytes) of basic C data types.

The number of bytes allocated varies with how the program is compiled. This chart shows the values typical of 32-bit and 64-bit programs.

## New to C? Declaring pointers

For any data type  $T$ , the declaration

```
T *p;
```

indicates that `p` is a pointer variable, pointing to an object of type  $T$ . For example,

```
char *p;
```

is the declaration of a pointer to an object of type `char`.

sizes. Even when compiled for 64-bit systems, data type `int` is usually just 4 bytes. Data type `long` commonly has 4 bytes in 32-bit

programs and 8 bytes in 64-bit programs.

To avoid the vagaries of relying on “typical” sizes and different compiler settings, ISO C99 introduced a class of data types where the data sizes are fixed regardless of compiler and machine settings. Among these are data types `int32_t` and `int64_t`, having exactly 4 and 8 bytes, respectively. Using fixed-size integer types is the best way for programmers to have close control over data representations.

Most of the data types encode signed values, unless prefixed by the keyword `unsigned` or using the specific unsigned declaration for fixed-size data types. The exception to this is data type `char`.

Although most compilers and machines treat these as signed data, the C standard does not guarantee this. Instead, as indicated by the square brackets, the programmer should use the declaration `signed char` to guarantee a 1-byte signed value. In many contexts, however, the program's behavior is insensitive to whether data type `char` is signed or unsigned.

The C language allows a variety of ways to order the keywords and to include or omit optional keywords. As examples, all of the following declarations have identical meaning:

```
|  
| unsigned long  
| unsigned long int  
| long unsigned  
| long unsigned int
```

We will consistently use the forms found in [Figure 2.3](#).

[Figure 2.3](#) also shows that a pointer (e.g., a variable declared as being of type `char *`) uses the full word size of the program. Most machines also support two different floating-point formats: single precision, declared in C as `float`, and double precision, declared in C as `double`. These formats use 4 and 8 bytes, respectively.

Programmers should strive to make their programs portable across different machines and compilers. One aspect of portability is to make the program insensitive to the exact sizes of the different data types. The C standards set lower bounds on the numeric ranges of the different data types, as will be covered later, but there are no upper bounds (except with the fixed-size types). With 32-bit machines and 32-bit programs being the dominant combination from around 1980 until around 2010, many programs have been written assuming the allocations listed for 32-bit programs in [Figure 2.3](#). With the transition to 64-bit machines, many hidden word size dependencies have arisen as bugs in migrating these programs to new machines. For example, many programmers historically assumed that an object declared as type `int` could be used to store

a pointer. This works fine for most 32-bit programs, but it leads to problems for 64-bit programs.

## 2.1.3 Addressing and Byte Ordering

For program objects that span multiple bytes, we must establish two conventions: what the address of the object will be, and how we will order the bytes in memory. In virtually all machines, a multi-byte object is stored as a contiguous sequence of bytes, with the address of the object given by the smallest address of the bytes used. For example, suppose a variable `x` of type `int` has address `0x100`; that is, the value of the address expression `&x` is `0x100`. Then (assuming data type `int` has a 32-bit representation) the 4 bytes of `x` would be stored in memory locations `0x100`, `0x101`, `0x102`, and `0x103`.

For ordering the bytes representing an object, there are two common conventions. Consider a  $w$ -bit integer having a bit representation  $[x_{w-1}, x_{w-2}, \dots, x_1, x_0]$ , where  $x_{w-1}$  is the most significant bit and  $x_0$  is the least. Assuming  $w$  is a multiple of 8, these bits can be grouped as bytes, with the most significant byte having bits  $[x_{w-1}, x_{w-2}, \dots, x_{w-8}]$ , the least significant byte having bits  $[x_7, x_6, \dots, x_0]$ , and the other bytes having bits from the middle. Some machines choose to store the object in memory ordered from least significant byte to most, while other machines store them from most to least. The former convention—where the least significant byte comes first—is referred to as *little endian*. The latter convention—where the most significant byte comes first—is referred to as *big endian*.



Suppose the variable `x` of type `int` and at address `0x100` has a hexadecimal value of `0x01234567`. The ordering of the bytes within the address range `0x100` through `0x103` depends on the type of machine:

Big endian

	0x100	0x101	0x102	0x103	
...	01	23	45	67	...

Little endian

	0x100	0x101	0x102	0x103	
...	67	45	23	01	...

Note that in the word `0x01234567` the high-order byte has hexadecimal value `0x01`, while the low-order byte has value `0x67`.

Most Intel-compatible machines operate exclusively in little-endian mode. On the other hand, most machines from IBM and Oracle (arising from their acquisition

## Aside Origin of “endian”

Here is how Jonathan Swift, writing in 1726, described the history of the controversy between big and little endians:

. . . Lilliput and Blefuscu . . . have, as I was going to tell you, been engaged in a most obstinate war for six-and-thirty moons past. It began upon the following occasion. It is allowed on all hands, that the primitive way of breaking eggs, before we eat them, was upon the larger end; but his present majesty's grandfather, while he was a boy, going to eat an egg, and breaking it according to the ancient practice, happened to cut one of his fingers. Whereupon the emperor his father published an edict, commanding all his subjects, upon great penalties, to break the smaller end of their eggs. The people so highly resented this law, that our histories tell us, there have been six rebellions raised on that account; wherein one emperor lost his life, and another his crown. These civil commotions were constantly fomented by the monarchs of Blefuscu; and when they were quelled, the exiles always fled for refuge to that empire. It is computed that eleven thousand persons have at several times suffered death, rather than submit to break their eggs at the smaller end. Many hundred large volumes have been published upon this controversy: but the books of the Big-endians have been long forbidden, and the whole party rendered incapable by law of holding employments.

*(Jonathan Swift. Gulliver's Travels, Benjamin Motte, 1726.)*

In his day, Swift was satirizing the continued conflicts between England (Lilliput) and France (Blefuscu). Danny Cohen, an early pioneer in networking protocols, first applied these terms to refer to byte ordering [24], and the terminology has been widely adopted.

of Sun Microsystems in 2010) operate in big-endian mode. Note that we said “most.” The conventions do not split precisely along corporate boundaries. For example, both IBM and Oracle manufacture machines that use Intel-compatible processors and hence are little endian. Many recent microprocessor chips are *bi-endian*, meaning that they can be configured to operate as either little- or big-endian machines. In practice, however, byte ordering becomes fixed once a particular operating system is chosen. For example, ARM microprocessors, used in many cell phones, have hardware that can operate in either little- or big-endian mode, but the two most common operating systems for these chips—Android (from Google) and IOS (from Apple) —operate only in little-endian mode.

People get surprisingly emotional about which byte ordering is the proper one. In fact, the terms “little endian” and “big endian” come from the book *Gulliver's Travels* by Jonathan Swift, where two warring factions could not agree as to how a soft-boiled egg should be opened—by the little end or by the big. Just like the egg issue, there is no technological reason to choose one byte ordering convention over the other, and hence the arguments degenerate into bickering about sociopolitical issues. As long as one of the conventions is selected and adhered to consistently, the choice is arbitrary.

For most application programmers, the byte orderings used by their machines are totally invisible; programs compiled for either class of machine give identical results. At times, however, byte ordering becomes an issue. The first is when binary data are communicated

over a network between different machines. A common problem is for data produced by a little-endian machine to be sent to a big-endian machine, or vice versa, leading to the bytes within the words being in reverse order for the receiving program. To avoid such problems, code written for networking applications must follow established conventions for byte ordering to make sure the sending machine converts its internal representation to the network standard, while the receiving machine converts the network standard to its internal representation. We will see examples of these conversions in [Chapter 11](#).


A second case where byte ordering becomes important is when looking at the byte sequences representing integer data. This occurs often when inspecting machine-level programs. As an example, the following line occurs in a file that gives a text representation of the machine-level code for an Intel x86–64 processor:

```
4004d3: 01 05 43 0b 20 00      add
%eax,0x200b43(%rip)
```

This line was generated by a *disassembler*, a tool that determines the instruction sequence represented by an executable program file. We will learn more about disassemblers and how to interpret lines such as this in [Chapter 3](#). For now, we simply note that this line states that the hexadecimal byte sequence `01 05 43 0b 20 00` is the byte-level representation of an instruction that adds a word of data to

the value stored at an address computed by adding `0x200b43` to the current value of the *program counter*, the address of the next instruction to be executed. If we take the final 4 bytes of the sequence `43 0b 20 00` and write them in reverse order, we have `00 20 0b 43`. Dropping the leading 0, we have the value `0x200b43`, the numeric value written on the right. Having bytes appear in reverse order is a common occurrence when reading machine-level program representations generated for little-endian machines such as this one. The natural way to write a byte sequence is to have the lowest-numbered byte on the left and the highest on the right, but this is contrary to the normal way of writing numbers with the most significant digit on the left and the least on the right.

A third case where byte ordering becomes visible is when programs are written that circumvent the normal type system. In the C language, this can be done using a *cast* or a *union* to allow an object to be referenced according to a different data type from which it was created. Such coding tricks are strongly discouraged for most application programming, but they can be quite useful and even necessary for system-level programming.

**Figure 2.4**  shows C code that uses casting to access and print the byte representations of different program objects. We use `typedef` to define data type `byte_pointer` as a pointer to an object of type `unsigned char`. Such a byte pointer references a sequence of bytes where each byte is considered to be a nonnegative integer. The first routine `show_bytes` is given the address of a sequence of bytes, indicated by a byte pointer, and a byte count. The byte count

is specified as having data type `size_t`, the preferred data type for expressing the sizes of data structures. It prints the individual bytes in hexadecimal. The C formatting directive `%.2x` indicates that an integer should be printed in hexadecimal with at least 2 digits.

```

1 #include <stdio.h>
2
3 typedef unsigned char *byte_pointer;
4
5 void show_bytes(byte_pointer start, size_t len) {
6     int i;
7     for (i = 0; i < len; i++)
8         printf(" %.2x", start[i]);
9     printf("\n");
10 }
11
12 void show_int(int x) {
13     show_bytes((byte_pointer) &x, sizeof(int));
14 }
15
16 void show_float(float x) {
17     show_bytes((byte_pointer) &, sizeof(float));
18 }
19
20 void show_pointer(void *x) {
21     show_bytes((byte_pointer) &, sizeof(void *));
22 }

```

**Figure 2.4** Code to print the byte representation of program objects.

This code uses casting to circumvent the type system. Similar functions are easily defined for other data types.

Procedures `show_int`, `show_float`, and `show_pointer` demonstrate how to use procedure `show_bytes` to print the byte representations of C program objects of type `int`, `float`, and `void *`, respectively. Observe that they simply pass `show_bytes` a pointer `&x` to their argument `x`, casting the pointer to be of type `unsigned char *`. This cast indicates to the compiler that the program should consider the pointer to be to a sequence of bytes rather than to an object of the original data type. This pointer will then be to the lowest byte address occupied by the object.

These procedures use the C `sizeof operator` to determine the number of bytes used by the object. In general, the expression `sizeof(T)` returns the number of bytes required to store an object of type `T`. Using `sizeof` rather than a fixed value is one step toward writing code that is portable across different machine types.

We ran the code shown in [Figure 2.5](#) on several different machines, giving the results shown in [Figure 2.6](#). The following machines were used:



```
|  
1 void test_show_bytes(int val) {  
2     int ival = val;  
3     float fval = (float) ival;  
4     int *pval = &ival;  
5     show_int(ival);  
6     show_float(fval);  
7     show_pointer(pval);  
8 }
```

**Figure 2.5 Byte representation examples.**

This code prints the byte representations of sample data objects.

## Figure 2.6 Byte representations of different data values.


Results for `int` and `float` are identical, except for byte ordering. Pointer values are machine dependent.

Our argument 12,345 has hexadecimal representation `0x00003039`. For the `int` data, we get identical results for all machines, except for the byte ordering. In particular, we can see that the least significant byte value of `0x39` is printed first for Linux 32, Windows, and Linux 64, indicating little-endian machines, and last for Sun, indicating a big-endian machine. Similarly, the bytes of the `float` data are identical, except for the byte ordering. On the other hand, the pointer values are completely different. The different machine/operating system configurations use different conventions for storage allocation. One feature to note is that the Linux 32, Windows, and Sun machines use 4-byte addresses, while the Linux 64 machine uses 8-byte addresses.

# New to C? Naming data types with

## `typedef`

The `typedef` declaration in C provides a way of giving a name to a data type. This can be a great help in improving code readability, since deeply nested type declarations can be difficult to decipher.

The syntax for `typedef` is exactly like that of declaring a variable, except that it uses a type name rather than a variable name. Thus, the declaration of `byte_pointer` in [Figure 2.4](#)  has the same form as the declaration of a variable of type `unsigned char *`.

For example, the declaration

```
typedef int *int_pointer;  
int_pointer ip;
```

defines type `int_pointerto` be a pointer to an int, and declares a variable `ip` of this type. Alternatively, we could declare this variable directly as

```
int *ip;
```

## New to C? Formatted printing with

### `printf`

The `printf` function (along with its cousins `fprintf` and `sprintf`) provides a way to print information with considerable control over the formatting details. The first argument is a *format string*, while any remaining arguments are values to be printed. Within the format string, each character sequence starting with `'%'` indicates how to format the next argument. Typical examples include `'%d'` to print a decimal integer, `'%f'` to print a floating-point number, and `'%c'` to print a character having the character code given by the argument.

Specifying the formatting of fixed-size data types, such as `int_32t`, is a bit more involved, as is described in the aside on page [67](#).

Observe that although the floating-point and the integer data both encode the numeric value 12,345, they have very different byte patterns: `0x00003039` for the integer and `0x4640E400` for floating point. In general, these two formats use different encoding schemes. If we expand these hexadecimal patterns into binary form and shift them

appropriately, we find a sequence of 13 matching bits, indicated by a sequence of asterisks, as follows:

```
    0  0  0  0  3  0  3  9
000000000000000000011000000111001
                *****
          4  6  4  0  E  4  0  0
01000110010000001110010000000000
```

This is not coincidental. We will return to this example when we study floating-point formats.

## New to C? Pointers and arrays

In function `show_bytes` ([Figure 2.4](#)), we see the close connection between pointers and arrays, as will be discussed in detail in [Section 3.8](#). We see that this function has an argument `start` of type `byte_pointer` (which has been defined to be a pointer to `unsigned char`), but we see the array reference `start[i]` on line 8. In C, we can dereference a pointer with array notation, and we can reference array elements with pointer notation. In this example, the reference `start[i]` indicates that we want to read the byte that is `i` positions beyond the location pointed to by `start`.

# New to C? Pointer creation and dereferencing

In lines 13, 17, and 21 of [Figure 2.4](#) we see uses of two operations that give C (and therefore C++) its distinctive character. The C “address of” operator `&` creates a pointer. On all three lines, the expression `&x` creates a pointer to the location holding the object indicated by variable `x`. The type of this pointer depends on the type of `x`, and hence these three pointers are of type `int *`, `float *`, and `void **`, respectively. (Data type `void *` is a special kind of pointer with no associated type information.)

The cast operator converts from one data type to another. Thus, the cast `(byte_pointer) &x` indicates that whatever type the pointer `&x` had before, the program will now reference a pointer to data of type `unsigned char`. The casts shown here do not change the actual pointer; they simply direct the compiler to refer to the data being pointed to according to the new data type.

## Aside Generating an ASCII table

You can display a table showing the ASCII character code by executing the command `man ascii.`

### *Practice Problem 2.5 (solution page **144**)*

Consider the following three calls to `show_bytes`:

```
|
int val = 0x87654321;
byte_pointer valp = (byte_pointer) &val;
show_bytes(valp, 1); /* A. */
show_bytes(valp, 2); /* B. */
show_bytes(valp, 3); /* C. */
```

Indicate the values that will be printed by each call on a little-endian machine and on a big-endian machine:

- A. Little endian: \_\_\_\_\_ Big endian: \_\_\_\_\_
- B. Little endian: \_\_\_\_\_ Big endian: \_\_\_\_\_
- C. Little endian: \_\_\_\_\_ Big endian: \_\_\_\_\_

## *Practice Problem 2.6 (solution page 145)*

Using `show_int` and `show_float`, we determine that the integer 3510593 has hexadecimal representation `0x00359141`, while the floating-point number 3510593.0 has hexadecimal representation `0x4A564504`.

- A. Write the binary representations of these two hexadecimal values.
- B. Shift these two strings relative to one another to maximize the number of matching bits. How many bits match?
- C. What parts of the strings do not match?



## 2.1.4 Representing Strings

A string in C is encoded by an array of characters terminated by the null (having value 0) character. Each character is represented by some standard encoding, with the most common being the ASCII character code. Thus, if we run our routine `show_bytes` with arguments `"12345"` and `6` (to include the terminating character), we get the result `31 32 33 34 35 00`. Observe that the ASCII code for decimal digit  $x$  happens to be `0x3x`, and that the terminating byte has the hex representation `0x00`. This same result would be obtained on any system using ASCII as its character code, independent of the byte ordering and word size conventions. As a consequence, text data are more platform independent than binary data.

### *Practice Problem 2.7 (solution page [145](#))*

What would be printed as a result of the following call to

`show_bytes?`

```
|  
const char *s = "abcdef";  
show_bytes((byte_pointer) s, strlen(s));
```

Note that letters `'a'` through `'z'` have ASCII codes `0x61` through `0x7A`.

## 2.1.5 Representing Code

Consider the following C function:

```
|  
1 int sum(int x, int y) {  
2     return x + y;  
3 }
```

When compiled on our sample machines, we generate machine code having the following byte representations:

# Aside The Unicode standard for text encoding


The ASCII character set is suitable for encoding English-language documents, but it does not have much in the way of special characters, such as the French 'ç'. It is wholly unsuited for encoding documents in languages such as Greek, Russian, and Chinese. Over the years, a variety of methods have been developed to encode text for different languages. The Unicode Consortium has devised the most comprehensive and widely accepted standard for encoding text. The current Unicode standard (version 7.0) has a repertoire of over 100,000 characters supporting a wide range of languages, including the ancient languages of Egypt and Babylon. To their credit, the Unicode Technical Committee rejected a proposal to include a standard writing for Klingon, a fictional civilization from the television series *Star Trek*.

The base encoding, known as the “Universal Character Set” of Unicode, uses a 32-bit representation of characters. This would seem to require every string of text to consist of 4 bytes per character. However, alternative codings are possible where common characters require just 1 or 2 bytes, while less common ones require more. In particular, the UTF-8 representation encodes each character as a sequence of bytes, such that the standard ASCII characters use the same single-byte encodings as they have in ASCII, implying that all

ASCII byte sequences have the same meaning in UTF-8 as they do in ASCII.

The Java programming language uses Unicode in its representations of strings. Program libraries are also available for C to support Unicode.

Here we find that the instruction codings are different. Different machine types use different and incompatible instructions and encodings. Even identical processors running different operating systems have differences in their coding conventions and hence are not binary compatible. Binary code is seldom portable across different combinations of machine and operating system.

A fundamental concept of computer systems is that a program, from the perspective of the machine, is simply a sequence of bytes. The machine has no information about the original source program, except perhaps some auxiliary tables maintained to aid in debugging. We will see this more clearly when we study machine-level programming in [Chapter 3](#) .

## 2.1.6 Introduction to Boolean Algebra

Since binary values are at the core of how computers encode, store, and manipulate information, a rich body of mathematical knowledge has evolved around the study of the values 0 and 1. This started with the work of George Boole (1815–1864) around 1850 and thus is known as *Boolean algebra*. Boole observed that by encoding logic values `TRUE` and `FALSE` as binary values 1 and 0, he could formulate an algebra that captures the basic principles of logical reasoning.

The simplest Boolean algebra is defined over the two-element set {0, 1}. [Figure 2.7](#) defines several operations in this algebra. Our symbols for representing these operations are chosen to match those used by the C bit-level operations,

$\sim$		$\&$	0	1	$ $	0	1	$\wedge$	0	1
<hr/>		<hr/>	0	1	<hr/>	0	1	<hr/>	0	1
0	1	0	0	0	0	0	1	0	0	1
1	0	1	0	1	1	1	1	1	1	0

**Figure 2.7 Operations of Boolean algebra.**

Binary values 1 and 0 encode logic values `TRUE` and `FALSE`, while operations  $\sim$ ,  $\&$ ,  $|$ , and  $\wedge$  encode logical operations `NOT`, `AND`, `OR`, and `EXCLUSIVE-OR`, respectively.

as will be discussed later. The Boolean operation  $\sim$  corresponds to the logical operation `NOT`, denoted by the symbol  $\neg$ . That is, we say

that  $\neg P$  is true when  $P$  is not true, and vice versa. Correspondingly,  $\sim p$  equals 1 when  $p$  equals 0, and vice versa. Boolean operation  $\&$  corresponds to the logical operation AND, denoted by the symbol  $\wedge$ . We say that  $P \wedge Q$  holds when both  $P$  is true and  $Q$  is true. Correspondingly,  $p \& q$  equals 1 only when  $p = 1$  and  $q = 1$ . Boolean operation  $|$  corresponds to the logical operation OR, denoted by the symbol  $\vee$ . We say that  $P \vee Q$  holds when either  $P$  is true or  $Q$  is true. Correspondingly,  $p | q$  equals 1 when either  $p = 1$  or  $q = 1$ . Boolean operation  $\wedge$  corresponds to the logical operation EXCLUSIVE-OR, denoted by the symbol  $\oplus$ . We say that  $P \oplus Q$  holds when either  $P$  is true or  $Q$  is true, but not both. Correspondingly,  $p \wedge q$  equals 1 when either  $p = 1$  and  $q = 0$ , or  $p = 0$  and  $q = 1$ .

Claude Shannon (1916–2001), who later founded the field of information theory, first made the connection between Boolean algebra and digital logic. In his 1937 master's thesis, he showed that Boolean algebra could be applied to the design and analysis of networks of electromechanical relays. Although computer technology has advanced considerably since, Boolean algebra still plays a central role in the design and analysis of digital systems.

We can extend the four Boolean operations to also operate on *bit vectors*, strings of zeros and ones of some fixed length  $w$ . We define the operations over bit vectors according to their applications to the matching elements of the arguments. Let  $a$  and  $b$  denote the bit vectors  $[a_{w-1}, a_{w-2}, \dots, a_0]$  and  $[b_{w-1}, b_{w-2}, \dots, b_0]$ , respectively. We define  $a \& b$  to also be a bit vector of length  $w$ ,

where the  $i$ th element equals  $a_i \& b_i$ , for  $0 \leq i < w$ . The operations  $|$ ,  $\wedge$ , and  $\sim$  are extended to bit vectors in a similar fashion.

As examples, consider the case where  $w = 4$ , and with arguments  $a = [0110]$  and  $b = [1100]$ . Then the four operations  $a \& b$ ,  $a | b$ ,  $a \wedge b$ , and  $\sim b$  yield

$$\begin{array}{cccc}
 & 0110 & 0110 & 0110 \\
 \& & | & \wedge & \sim \\
 & 1100 & 1100 & 1100 & 1100 \\
 & \overline{0100} & \overline{1110} & \overline{1010} & \overline{0011}
 \end{array}$$

## *Practice Problem 2.8 (solution page [145](#))*

Fill in the following table showing the results of evaluating Boolean operations on bit vectors.



# Web Aside DATA:BOOL More on Boolean algebra and Boolean rings

The Boolean operations `|`, `&`, and `~` operating on bit vectors of length  $w$  form a *Boolean algebra*, for any integer  $w > 0$ . The simplest is the case where  $w = 1$  and there are just two elements, but for the more general case there are  $2^w$  bit vectors of length  $w$ .

Boolean algebra has many of the same properties as arithmetic over integers. For example, just as multiplication distributes over addition, written  $a \cdot (b + c) = (a \cdot b) + (a \cdot c)$ , Boolean operation `&` distributes over `|`, written  $a \& (b | c) = (a \& b) | (a \& c)$ . In addition, however, Boolean operation `|` distributes over `&`, and so we can write  $a | (b \& c) = (a | b) \& (a | c)$ , whereas we cannot say that  $a + (b \cdot c) = (a + b) \cdot (a + c)$  holds for all integers.

When we consider operations `^`, `&`, and `~` operating on bit vectors of length  $w$ , we get a different mathematical form, known as a *Boolean ring*. Boolean rings have many properties in common with integer arithmetic. For example, one property of integer arithmetic is that every value  $x$  has an *additive inverse*  $-x$ , such that  $x + -x = 0$ . A similar property holds for Boolean rings, where `^` is the “addition” operation, but in this case

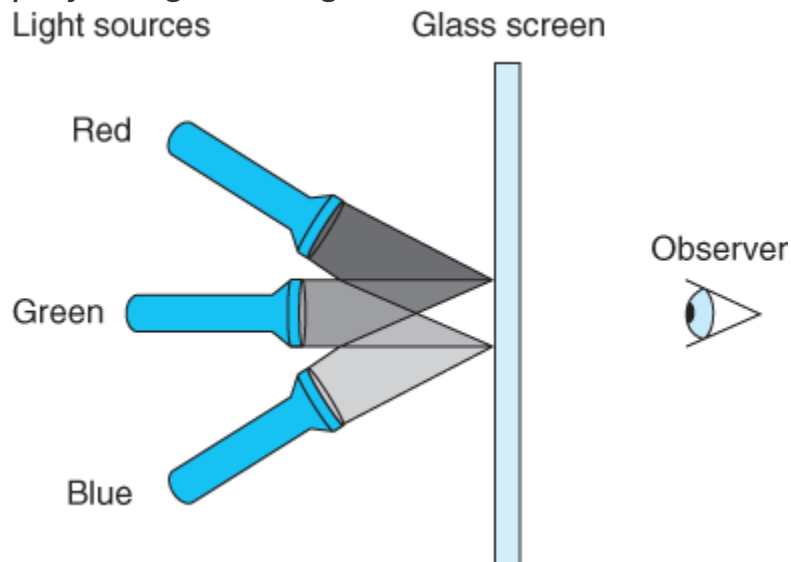
each element is its own additive inverse. That is,  $a \wedge a = 0$  for any value  $a$ , where we use 0 here to represent a bit vector of all zeros. We can see this holds for single bits, since  $0 \wedge 0 = 1 \wedge 1 = 0$ , and it extends to bit vectors as well. This property holds even when we rearrange terms and combine them in a different order, and so  $(a \wedge b) \wedge a = b$ . This property leads to some interesting results and clever tricks, as we will explore in [Problem 2.10](#).

One useful application of bit vectors is to represent finite sets. We can encode any subset  $A \subseteq \{0, 1, \dots, w - 1\}$  with a bit vector  $[a_{w-1}, \dots, a_1, a_0]$ , where  $a_i = 1$  if and only if  $i \in A$ . For example, recalling that we write  $a_{w-1}$  on the left and  $a_0$  on the right, bit vector  $a = [01101001]$  encodes the set  $A = \{0, 3, 5, 6\}$ , while bit vector  $b = [01010101]$  encodes the set  $B = \{0, 2, 4, 6\}$ . With this way of encoding sets, Boolean operations  $|$  and  $\&$  correspond to set union and intersection, respectively, and  $\sim$  corresponds to set complement. Continuing our earlier example, the operation  $a \& b$  yields bit vector  $[01000001]$ , while  $A \cap B = \{0, 6\}$ .

We will see the encoding of sets by bit vectors in a number of practical applications. For example, in [Chapter 8](#), we will see that there are a number of different *signals* that can interrupt the execution of a program. We can selectively enable or disable different signals by specifying a bit-vector mask, where a 1 in bit position  $i$  indicates that signal  $i$  is enabled and a 0 indicates that it is disabled. Thus, the mask represents the set of enabled signals.

## Practice Problem 2.9 (solution page 146)

Computers generate color pictures on a video screen or liquid crystal display by mixing three different colors of light: red, green, and blue. Imagine a simple scheme, with three different lights, each of which can be turned on or off, projecting onto a glass screen:



We can then create eight different colors based on the absence (0) or presence (1) of light sources  $R$ ,  $G$ , and  $B$ :

Each of these colors can be represented as a bit vector of length 3, and we can apply Boolean operations to them.

A. The complement of a color is formed by turning off the lights that are on and turning on the lights that are off. What would be the complement of each of the eight colors listed above?

B. Describe the effect of applying Boolean operations on the following colors:

Blue | Green = \_\_\_\_\_

Yellow & Cyan = \_\_\_\_\_

Red ^ Magenta = \_\_\_\_\_

## 2.1.7 Bit-Level Operations in C

One useful feature of C is that it supports bitwise Boolean operations. In fact, the symbols we have used for the Boolean operations are exactly those used by C: `|` for OR, `&` for AND, `~` for NOT, and `^` for EXCLUSIVE-OR. These can be applied to any “integral” data type, including all of those listed in [Figure 2.3](#). Here are some examples of expression evaluation for data type `char`:

As our examples show, the best way to determine the effect of a bit-level expression is to expand the hexadecimal arguments to their binary representations, perform the operations in binary, and then convert back to hexadecimal.

## Practice Problem 2.10 (solution page 146)

As an application of the property that  $a \wedge a = 0$  for any bit vector  $a$ , consider the following program:

```
1 void inplace_swap(int *x, int *y) {  
2     *y = *x ^ *y;    /* Step 1 */  
3     *x = *x ^ *y;    /* Step 2 */  
4     *y = *x ^ *y;    /* Step 3 */  
5 }
```

As the name implies, we claim that the effect of this procedure is to swap the values stored at the locations denoted by pointer variables `x` and `y`. Note that unlike the usual technique for swapping two values, we do not need a third location to temporarily store one value while we are moving the other. There is no performance advantage to this way of swapping; it is merely an intellectual amusement.

Starting with values  $a$  and  $b$  in the locations pointed to by `x` and `y`, respectively, fill in the table that follows, giving the values stored at the two locations after each step of the procedure. Use the properties of  $\wedge$  to show that the desired effect is achieved. Recall that every element is its own additive inverse (that is,  $a \wedge a = 0$ ).

## Practice Problem 2.11 (solution page 146)

Armed with the function `inplace_swap` from [Problem 2.10](#), you decide to write code that will reverse the elements of an array by swapping elements from opposite ends of the array, working toward the middle.

You arrive at the following function:

```
1 void reverse_array(int a[], int cnt) {  
2     int first, last;  
3     for (first = 0, last = cnt-1;  
4         first <= last;  
5         first++, last-)  
6         inplace_swap(&a[first], &a[last]);  
7 }
```

When you apply your function to an array containing elements 1, 2, 3, and 4, you find the array now has, as expected, elements 4, 3, 2, and 1. When you try it on an array with elements 1, 2, 3, 4, and 5, however, you are surprised to see that the array now has elements 5, 4, 0, 2, and 1. In fact, you discover that the code always works correctly on arrays of even length, but it sets the middle element to 0 whenever the array has odd length.

- A. For an array of odd length `cnt = 2k + 1`, what are the values of variables `first` and `last` in the final iteration of function `reverse_array`?
- B. Why does this call to function `inplace_swap` set the array element to 0?
- C. What simple modification to the code for `reverse_array` would eliminate this problem?

One common use of bit-level operations is to implement *masking* operations, where a mask is a bit pattern that indicates a selected set of bits within a word. As an example, the mask `0xFF` (having ones for the least significant 8 bits) indicates the low-order byte of a word. The bit-level operation `x & 0xFF` yields a value consisting of the least significant byte of `x`, but with all other bytes set to 0. For example, with `x = 0x89ABCDEF`, the expression would yield `0x000000EF`. The expression `~0` will yield a mask of all ones, regardless of the size of the data representation. The same mask can be written `0xFFFFFFFF` when data type `int` is 32 bits, but it would not be as portable.



## Practice Problem 2.12 (solution page 146)

Write C expressions, in terms of variable `x`, for the following values. Your code should work for any word size  $w \geq 8$ . For reference, we show the result of evaluating the expressions for `x = 0x87654321`, with  $w = 32$ .

- A. The least significant byte of `x`, with all other bits set to 0. `[0x00000021]`
- B. All but the least significant byte of `x` complemented, with the least significant byte left unchanged. `[0x789ABC21]`
- C. The least significant byte set to all ones, and all other bytes of `x` left unchanged. `[0x876543FF]`

## Practice Problem 2.13 (solution page 147)

The Digital Equipment VAX computer was a very popular machine from the late 1970s until the late 1980s. Rather than instructions for Boolean operations `AND` and `OR`, it had instructions `bis` (bit set) and `bic` (bit clear). Both instructions take a data word `x` and a mask word `m`. They generate a result `z` consisting of the bits of `x` modified according to the bits of `m`. With `bis`, the modification involves setting `z` to 1 at each bit position where `m` is 1. With `bic`, the modification involves setting `z` to 0 at each bit position where `m` is 1. To see how these operations relate to the C bit-level operations, assume we have functions `bis` and `bic` implementing the bit set and bit clear operations, and that we want to use these to implement functions computing bitwise operations `|` and `^`, without using any other C operations. Fill in the missing code below. *Hint:* Write C expressions for the operations `bis` and `bic`.

```
|
/* Declarations of functions implementing operations bis
and bic */
int bis(int x, int m);
int bic(int x, int m);

/* Compute x|y using only calls to functions bis and bic
*/
int bool_or(int x, int y) {
    int result = _____;
    return result;
}

/* Compute x^y using only calls to functions bis and bic
*/
int bool_xor(int x, int y) {
    int result = _____;
    return result;
}
```

## 2.1.8 Logical Operations in C

C also provides a set of *logical* operators `||`, `&&`, and `!`, which correspond to the OR, AND, and NOT operations of logic. These can easily be confused with the bit-level operations, but their behavior is quite different. The logical operations treat any nonzero argument as representing `TRUE` and argument 0 as representing `FALSE`. They return either 1 or 0, indicating a result of either `TRUE` OR `FALSE`, respectively. Here are some examples of expression evaluation:

Observe that a bitwise operation will have behavior matching that of its logical counterpart only in the special case in which the arguments are restricted to 0 or 1.

A second important distinction between the logical operators `&&` and `||` versus their bit-level counterparts `&` and `|` is that the logical operators do not evaluate their second argument if the result of the expression can be determined by evaluating the first argument. Thus, for example, the expression `a && 5/a` will never cause a division by zero, and the expression `p && *p++` will never cause the dereferencing of a null pointer.

## *Practice Problem 2.14 (solution page 147)*

Suppose that `x` and `y` have byte values `0x66` and `0x39`, respectively. Fill in the following table indicating the byte values of the different C expressions:

## *Practice Problem 2.15 (solution page 148)*

Using only bit-level and logical operations, write a C expression that is equivalent to `x == y`. In other words, it will return 1 when `x` and `y` are equal and 0 otherwise.

## 2.1.9 Shift Operations in C

C also provides a set of *shift* operations for shifting bit patterns to the left and to the right. For an operand `x` having bit representation  $[x_{w-1}, x_{w-2}, \dots, x_0]$ , the C expression `x << k` yields a value with bit representation  $[x_{w-k-1}, x_{w-k-2}, \dots, x_0, 0, \dots, 0]$ . That is, `x` is shifted  $k$  bits to the left, dropping off the  $k$  most significant bits and filling the right end with  $k$  zeros. The shift amount should be a value between 0 and  $w - 1$ . Shift operations associate from left to right, so `x << j << k` is equivalent to `(x << j) << k`.

There is a corresponding right shift operation, written in C as `x >> k`, but it has a slightly subtle behavior. Generally, machines support two forms of right shift:

**Logical** . A logical right shift fills the left end with  $k$  zeros, giving a result  $[0, \dots, 0, x_{w-1}, x_{w-2}, \dots, x_k]$ .

**Arithmetic**. An arithmetic right shift fills the left end with  $k$  repetitions of the most significant bit, giving a result  $[x_{w-1}, \dots, x_{w-1}, x_{w-1}, x_{w-2}, \dots, x_k]$ . This convention might seem peculiar, but as we will see, it is useful for operating on signed integer data.

As examples, the following table shows the effect of applying the different shift operations to two different values of an 8-bit argument  $x$ :

The italicized digits indicate the values that fill the right (left shift) or left (right shift) ends. Observe that all but one entry involves filling with zeros. The exception is the case of shifting [10010101] right arithmetically. Since its most significant bit is 1, this will be used as the fill value.

The C standards do not precisely define which type of right shift should be used with signed numbers—either arithmetic or logical shifts may be used. This unfortunately means that any code assuming one form or the other will potentially encounter portability problems. In practice, however, almost all compiler/machine combinations use arithmetic right shifts for signed data, and many programmers assume this to be the case. For unsigned data, on the other hand, right shifts must be logical.

In contrast to C, Java has a precise definition of how right shifts should be performed. The expression `x >> k` shifts `x` arithmetically by `k` positions, while `x >>> k` shifts it logically.

## *Practice Problem 2.16 (solution page 148)*

Fill in the table below showing the effects of the different shift operations on single-byte quantities. The best way to think about shift operations is to work with binary representations. Convert the initial values to binary, perform the shifts, and then convert back to hexadecimal. Each of the answers should be 8 binary digits or 2 hexadecimal digits.



## Aside Shifting by $k$ , for large values of $k$

For a data type consisting of  $w$  bits, what should be the effect of shifting by some value  $k \geq w$ ? For example, what should be the effect of computing the following expressions, assuming data type `int` has  $w = 32$ :

```
int lval = 0xFEDCBA98 << 32;  
int aval = 0xFEDCBA98 >> 36;  
unsigned uval = 0xFEDCBA98u >> 40;
```

The C standards carefully avoid stating what should be done in such a case. On many machines, the shift instructions consider only the lower  $\log_2 w$  bits of the shift amount when shifting a  $w$ -bit value, and so the shift amount is computed as  $k \bmod w$ . For example, with  $w = 32$ , the above three shifts would be computed as if they were by amounts 0, 4, and 8, respectively, giving results

```
lval    0xFEDCBA98  
aval    0xFFEDCBA9  
uval    0x00FEDCBA
```

This behavior is not guaranteed for C programs, however, and so shift amounts should be kept less than the word size.

Java, on the other hand, specifically requires that shift amounts should be computed in the modular fashion we have shown.


## Aside Operator precedence issues with shift operations

It might be tempting to write the expression `1<<2 + 3<<4`, intending it to mean `(1<<2) + (3<<4)`. However, in C the former expression is equivalent to `1 << (2+3) << 4`, since addition (and subtraction) have higher precedence than shifts. The left-to-right associativity rule then causes this to be parenthesized as `(1 << (2+3)) << 4`, giving value 512, rather than the intended 52.

Getting the precedence wrong in C expressions is a common source of program errors, and often these are difficult to spot by inspection. When in doubt, put in parentheses!

## 2.2 Integer Representations

In this section, we describe two different ways bits can be used to encode integers—one that can only represent nonnegative numbers, and one that can represent negative, zero, and positive numbers. We will see later that they are strongly related both in their mathematical properties and their machine-level implementations. We also investigate the effect of expanding or shrinking an encoded integer to fit a representation with a different length.

**Figure 2.8**  lists the mathematical terminology we introduce to precisely define and characterize how computers encode and operate on integer data. This

**Figure 2.8 Terminology for integer data and arithmetic operations.**

The subscript  $w$  denotes the number of bits in the data representation. The “Page” column indicates the page on which the term is defined.

terminology will be introduced over the course of the presentation. The figure is included here as a reference.

## 2.2.1 Integral Data Types

C supports a variety of *integral* data types—ones that represent finite ranges of integers. These are shown in [Figures 2.9](#) and [2.10](#), along with the ranges of values they can have for “typical” 32- and 64-bit programs. Each type can specify a size with keyword `char`, `short`, `long`, as well as an indication of whether the represented numbers are all nonnegative (declared as `unsigned`), or possibly negative (the default.) As we saw in [Figure 2.3](#), the number of bytes allocated for the different sizes varies according to whether the program is compiled for 32 or 64 bits. Based on the byte allocations, the different sizes allow different ranges of values to be represented. The only machine-dependent range indicated is for size designator `long`. Most 64-bit programs use an 8-byte representation, giving a much wider range of values than the 4-byte representation used with 32-bit programs.

One important feature to note in [Figures 2.9](#) and [2.10](#) is that the ranges are not symmetric—the range of negative numbers extends one further than the range of positive numbers. We will see why this happens when we consider how negative numbers are represented.

**Figure 2.9 Typical ranges for C integral data types for 32-bit programs.**

### Figure 2.10 Typical ranges for C integral data types for 64-bit programs.

The C standards define minimum ranges of values that each data type must be able to represent. As shown in [Figure 2.11](#), their ranges are the same or smaller than the typical implementations shown in [Figures 2.9](#) and [2.10](#). In particular, with the exception of the fixed-size data types, we see that they require only a

## New to C? Signed and unsigned numbers in C, C++, and Java

Both C and C++ support signed (the default) and unsigned numbers. Java supports only signed numbers.

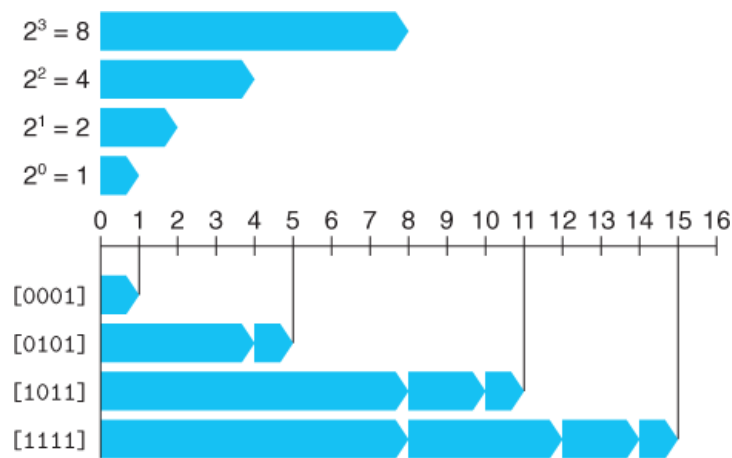
### Figure 2.11 Guaranteed ranges for C integral data types.

The C standards require that the data types have at least these ranges of values.

symmetric range of positive and negative numbers. We also see that data type `int` could be implemented with 2-byte numbers, although this is mostly a throwback to the days of 16-bit machines. We also see that size long can be implemented with 4-byte numbers, and it typically is for 32-bit programs. The fixed-size data types guarantee that the ranges of values will be exactly those given by the typical numbers of [Figure 2.9](#), including the asymmetry between negative and positive.

## 2.2.2 Unsigned Encodings

Let us consider an integer data type of  $w$  bits. We write a bit vector as either  $\vec{x}$ , to denote the entire vector, or as  $[x_{w-1}, x_{w-2}, \dots, x_0]$  to denote the individual bits within the vector. Treating  $\vec{x}$  as a number written in binary notation, we obtain the *unsigned* interpretation of  $\vec{x}$ . In this encoding, each bit  $x_i$  has value 0 or 1, with the latter case indicating that value  $2^i$  should be included as part of the numeric value. We can express this interpretation as a function  $B2U_w$  (for “binary to unsigned,” length  $w$ ):



**Figure 2.12 Unsigned number examples for**

$w = 4$ . When bit  $i$  in the binary representation has value 1, it contributes  $2^i$  to the value.



## Principle:

Definition of unsigned encoding

For vector  $\vec{x} = [x_{w-1}, x_{w-2}, \dots, x_0]$  :

$$B2U_w(\vec{x}) \doteq \sum_{i=0}^{w-1} x_i 2^i \quad (2.1)$$

In this equation, the notation  $\doteq$  means that the left-hand side is defined to be equal to the right-hand side. The function  $B2U_w$  maps strings of zeros and ones of length  $w$  to nonnegative integers. As examples, [Figure 2.12](#) shows the mapping, given by  $B2U$ , from bit vectors to integers for the following cases:

$$\begin{aligned} B2U_4([0001]) &= 0 \cdot 2^3 + 0 \cdot 2^2 + 0 \cdot 2^1 + 1 \cdot 2^0 = 0 + 0 + 0 + 1 = 1 \\ B2U_4([0101]) &= 0 \cdot 2^3 + 1 \cdot 2^2 + 0 \cdot 2^1 + 1 \cdot 2^0 = 0 + 4 + 0 + 1 = 5 \\ B2U_4([1011]) &= 1 \cdot 2^3 + 0 \cdot 2^2 + 1 \cdot 2^1 + 1 \cdot 2^0 = 8 + 0 + 2 + 1 = 11 \\ B2U_4([1111]) &= 1 \cdot 2^3 + 1 \cdot 2^2 + 1 \cdot 2^1 + 1 \cdot 2^0 = 8 + 4 + 2 + 1 = 15 \end{aligned} \quad (2.2)$$

In the figure, we represent each bit position  $i$  by a rightward-pointing blue bar of length  $2^i$ . The numeric value associated with a bit vector then equals the sum of the lengths of the bars for which the corresponding bit values are 1.

Let us consider the range of values that can be represented using  $w$  bits. The least value is given by bit vector  $[00 \dots 0]$  having integer value 0, and the greatest value is given by bit vector  $[11 \dots 1]$  having integer value  $UMax_w \doteq \sum_{i=0}^{w-1} 2^i = 2^w - 1$ . Using the 4-bit case as an example, we have  $UMax_4 = B2U_4([1111]) = 2^4 - 1 = 15$ . Thus, the function  $B2U_w$  can be defined as a mapping  $B2U_w : \{0, 1\}^w \rightarrow \{0, \dots, UMax_w\}$ .

The unsigned binary representation has the important property that every number between 0 and  $2^w - 1$  has a unique encoding as a  $w$ -bit value. For example, there is only

one representation of decimal value 11 as an unsigned 4-bit number—namely, [1011]. We highlight this as a mathematical principle, which we first state and then explain.

### **Principle:**

Uniqueness of unsigned encoding

Function  $B2U_w$  is a bijection.

The mathematical term *bijection* refers to a function  $f$  that goes two ways: it maps a value  $x$  to a value  $y$  where  $y = f(x)$ , but it can also operate in reverse, since for every  $y$ , there is a unique value  $x$  such that  $f(x) = y$ . This is given by the *inverse* function  $f^{-1}$ , where, for our example,  $x = f^{-1}(y)$ . The function  $B2U_w$  maps each bit vector of length  $w$  to a unique number between 0 and  $2^w - 1$ , and it has an inverse, which we call  $U2B_w$  (for “unsigned to binary”), that maps each number in the range 0 to  $2^w - 1$  to a unique pattern of  $w$  bits.

## 2.2.3 Two's-Complement Encodings

For many applications, we wish to represent negative values as well. The most common computer representation of signed numbers is known as *two's-complement* form. This is defined by interpreting the most significant bit of the word to have negative weight. We express this interpretation as a function  $B2T_w$  (for “binary to two's complement” length  $w$ ):

### Principle:

Definition of two's-complement encoding

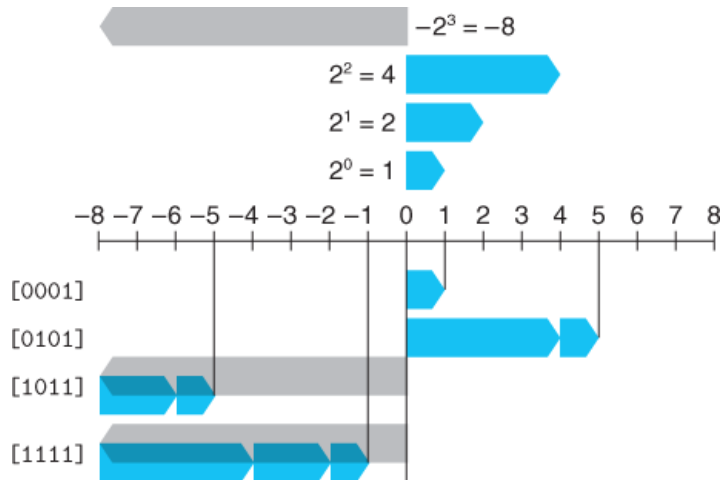
For vector  $\vec{x} = [x_{w-1}, x_{w-2}, \dots, x_0]$ :

$$B2T_w(\vec{x}) = -x_{w-1}2^{w-1} + \sum_{i=0}^{w-2} x_i 2^i \quad (2.3)$$

The most significant bit  $x_{w-1}$  is also called the *sign bit*. Its “weight” is  $-2^{w-1}$ , the negation of its weight in an unsigned representation. When the sign bit is set to 1, the represented value is negative, and when set to 0, the value is nonnegative. As examples, [Figure 2.13](#) shows the mapping, given by  $B2T$ , from bit vectors to integers for the following cases:

$$\begin{aligned} B2T_4([0001]) &= -0 \cdot 2^3 + 0 \cdot 2^2 + 0 \cdot 2^1 + 1 \cdot 2^0 = 0 + 0 + 0 + 1 = 1 \\ B2T_4([0101]) &= -0 \cdot 2^3 + 1 \cdot 2^2 + 0 \cdot 2^1 + 1 \cdot 2^0 = 0 + 4 + 0 + 1 = 5 \\ B2T_4([1011]) &= -1 \cdot 2^3 + 0 \cdot 2^2 + 1 \cdot 2^1 + 1 \cdot 2^0 = -8 + 0 + 2 + 1 = -5 \\ B2T_4([1111]) &= -1 \cdot 2^3 + 1 \cdot 2^2 + 1 \cdot 2^1 + 1 \cdot 2^0 = -8 + 4 + 2 + 1 = -1 \end{aligned} \quad (2.4)$$

In the figure, we indicate that the sign bit has negative weight by showing it as a leftward-pointing gray bar. The numeric value associated with a bit vector is then given by the combination of the possible leftward-pointing gray bar and the rightward-pointing blue bars.



**Figure 2.13** Two's-complement number examples for

$w = 4$ . Bit 3 serves as a sign bit; when set to 1, it contributes  $-2^3 = -8$  to the value. This weighting is shown as a leftward-pointing gray bar.

We see that the bit patterns are identical for [Figures 2.12](#) and [2.13](#) (as well as for [Equations 2.2](#) and [2.4](#)), but the values differ when the most significant bit is 1, since in one case it has weight  $+8$ , and in the other case it has weight  $-8$ .

Let us consider the range of values that can be represented as a  $w$ -bit two's-complement number. The least representable value is given by bit vector  $[10 \dots 0]$  (set the bit with negative weight but clear all others), having integer value  $TMin_w \doteq -2^{w-1}$ . The greatest value is given by bit vector  $[01 \dots 1]$  (clear the bit with negative weight but set all others), having integer value  $TMax_w \doteq \sum_{i=0}^{w-2} 2^i = 2^{w-1} - 1$ . Using the 4-bit case as an example, we have  $TMin_4 = B2T_4([1000]) = -2^3 = -8$  and  $TMax_4 = B2T_4([0111]) = 2^2 + 2^1 + 2^0 = 4 + 2 + 1 = 7$ .

We can see that  $B2T_w$  is a mapping of bit patterns of length  $w$  to numbers between  $TMin_w$  and  $TMax_w$ , written as  $B2T_w : \{0, 1\}^w \rightarrow \{TMin_w, \dots, TMax_w\}$ . As we saw with the unsigned representation, every number within the representable range has a unique encoding as a  $w$ -bit two's-complement number. This leads to a principle for two's-complement numbers similar to that for unsigned numbers:

## Principle:

Uniqueness of two's-complement encoding

Function  $B2T_w$  is a bijection.

We define function  $T2B_w$  (for “two's complement to binary”) to be the inverse of  $B2T_w$ . That is, for a number  $x$ , such that  $TMin_w \leq x \leq TMax_w$ ,  $T2B_w(x)$  is the (unique)  $w$ -bit pattern that encodes  $x$ .

## Practice Problem 2.17 (solution page 148)

Assuming  $w = 4$ , we can assign a numeric value to each possible hexadecimal digit, assuming either an unsigned or a two's-complement interpretation. Fill in the following table according to these interpretations by writing out the nonzero powers of 2 in the summations shown in [Equations 2.1](#) and [2.3](#):

[Figure 2.14](#) shows the bit patterns and numeric values for several important numbers for different word sizes. The first three give the ranges of representable integers in terms of the values of  $UMax_w$ ,  $TMin_w$ , and  $TMax_w$ . We will refer to these three special values often in the ensuing discussion. We will drop the subscript  $w$  and refer to the values  $UMax$ ,  $TMin$ , and  $TMax$  when  $w$  can be inferred from context or is not central to the discussion.

A few points are worth highlighting about these numbers. First, as observed in [Figures 2.9](#) and [2.10](#), the two's-complement range is asymmetric:  $|TMin| = |TMax| + 1$ ; that is, there is no positive counterpart to  $TMin$ . As we shall see, this leads to some peculiar properties of two's-complement arithmetic and can be the source of subtle program bugs. This asymmetry arises because half the bit patterns (those with the sign bit set to 1) represent negative numbers, while half (those with the sign bit set to 0) represent nonnegative numbers. Since 0 is nonnegative, this means that it can represent one less positive number than negative. Second, the maximum unsigned value is just over twice the maximum two's-complement value:  $UMax = 2TMax + 1$ . All of the bit patterns that

denote negative numbers in two's-complement notation become positive values in an unsigned representation.

**Figure 2.14 Important numbers.**

Both numeric values and hexadecimal representations are shown.

## Aside More on fixed-size integer types

For some programs, it is essential that data types be encoded using representations with specific sizes. For example, when writing programs to enable a machine to communicate over the Internet according to a standard protocol, it is important to have data types compatible with those specified by the protocol. We have seen that some C data types, especially `long`, have different ranges on different machines, and in fact the C standards only specify the minimum ranges for any data type, not the exact ranges. Although we can choose data types that will be compatible with standard representations on most machines, there is no guarantee of portability.

We have already encountered the 32- and 64-bit versions of fixed-size integer types ([Figure 2.3](#)); they are part of a larger class of data types. The ISO C99 standard introduces this class of integer types in the file `stdint.h`. This file defines a set of data types with declarations of the form `intN_t` and `uintN_t`, specifying  $N$ -bit signed and unsigned integers, for different values of  $N$ . The exact values of  $N$  are implementation dependent, but most compilers allow values of 8, 16, 32, and 64. Thus, we can unambiguously declare an unsigned 16-bit variable by giving it type `uint16_t`, and a signed variable of 32 bits as `int32_t`.

Along with these data types are a set of macros defining the minimum and maximum values for each value of  $N$ . These have names of the form `INTN_MIN`, `INTN_MAX`, and `UINTN_MAX`.

Formatted printing with fixed-width types requires use of macros that expand into format strings in a system-dependent manner. So, for example, the values of variables  $x$  and  $y$  of type `int32_t` and `uint64_t` can be printed by the following call to `printf`:

```
printf("x = %" PRId32 ", y = %" PRIu64 "\n", x, y);
```

When compiled as a 64-bit program, macro `PRId32` expands to the string `"d"`, while `PRIu64` expands to the pair of strings `"l" "u"`. When the C preprocessor encounters a sequence of string constants separated only by spaces (or other

whitespace characters), it concatenates them together. Thus, the above call to `printf` becomes

```
printf("x = %d, y = %lu\n", x, y);
```

Using the macros ensures that a correct format string will be generated regardless of how the code is compiled.

**Figure 2.14** also shows the representations of constants  $-1$  and  $0$ . Note that  $-1$  has the same bit representation as  $UMax$ —a string of all ones. Numeric value  $0$  is represented as a string of all zeros in both representations.

The C standards do not require signed integers to be represented in two's-complement form, but nearly all machines do so. Programmers who are concerned with maximizing portability across all possible machines should not assume any particular range of representable values, beyond the ranges indicated in **Figure 2.11**, nor should they assume any particular representation of signed numbers. On the other hand, many programs are written assuming a two's-complement representation of signed numbers, and the "typical" ranges shown in **Figures 2.9** and **2.10**, and these programs are portable across a broad range of machines and compilers. The file `<limits.h>` in the C library defines a set of constants



## Aside Alternative representations of signed numbers

There are two other standard representations for signed numbers:

**Ones' complement.** This is the same as two's complement, except that the most significant bit has weight  $-(2^{w-1} - 1)$  rather than  $-2^{w-1}$ :

$$B2O_w(\vec{x}) \doteq -x_{w-1}(2^{w-1} - 1) + \sum_{i=0}^{w-2} x_i 2^i$$

**Sign-magnitude.** The most significant bit is a sign bit that determines whether the remaining bits should be given negative or positive weight:

$$B2S_w(\vec{x}) \doteq (-1)^{x_{w-1}} \left( \sum_{i=0}^{w-2} x_i 2^i \right)$$

Both of these representations have the curious property that there are two different encodings of the number 0. For both representations,  $[00 \dots 0]$  is interpreted as  $+0$ . The value  $-0$  can be represented in sign-magnitude form as  $[10 \dots 0]$  and in ones' complement as  $[11 \dots 1]$ . Although machines based on ones'-complement representations were built in the past, almost all modern machines use two's complement. We will see that sign-magnitude encoding is used with floating-point numbers.

Note the different position of apostrophes: *two's* complement versus *ones'* complement. The term "two's complement" arises from the fact that for nonnegative  $x$  we compute a  $w$ -bit representation of  $-x$  as  $2^w - x$  (a single two.) The term "ones' complement" comes from the property that we can compute  $-x$  in this notation as  $[111 \dots 1] - x$  (multiple ones).

delimiting the ranges of the different integer data types for the particular machine on which the compiler is running. For example, it defines constants `INT_MAX`, `INT_MIN`, and `UINT_MAX` describing the ranges of signed and unsigned integers. For a two's-complement machine in which data type `int` has  $w$  bits, these constants correspond to the values of  $TMax_w$ ,  $TMin_w$ , and  $UMax_w$ .

The Java standard is quite specific about integer data type ranges and representations. It requires a two's-complement representation with the exact ranges shown for the 64-bit case ([Figure 2.10](#)). In Java, the single-byte data type is called `byte` instead of `char`. These detailed requirements are intended to enable Java programs to behave identically regardless of the machines or operating systems running them.

To get a better understanding of the two's-complement representation, consider the following code example:

```
1 short x = 12345;
2 short mx = -x;
3
4 show_bytes((byte_pointer) &x, sizeof(short));
5 show_bytes((byte_pointer) &mx, sizeof(short));
```

**Figure 2.15 Two's-complement representations of 12,345 and –12,345, and unsigned representation of 53,191.**

Note that the latter two have identical bit representations.

When run on a big-endian machine, this code prints `30 39` and `cf c7`, indicating that `x` has hexadecimal representation `0x3039`, while `mx` has hexadecimal representation `0xcfc7`. Expanding these into binary, we get bit patterns `[001100000111001]` for `x` and `[110011111000111]` for `mx`. As [Figure 2.15](#) shows, [Equation 2.3](#) yields values 12,345 and –12,345 for these two bit patterns.

## *Practice Problem 2.18 (solution page 149)*

In [Chapter 3](#), we will look at listings generated by a *disassembler*, a program that converts an executable program file back to a more readable ASCII form. These files contain many hexadecimal numbers, typically representing values in two's-complement form. Being able to recognize these numbers and understand their significance (for example, whether they are negative or positive) is an important skill.

For the lines labeled A–I (on the right) in the following listing, convert the hexadecimal values (in 32-bit two's-complement form) shown to the right of the instruction names (`sub`, `mov`, and `add`) into their decimal equivalents:

## 2.2.4 Conversions between Signed and Unsigned

C allows casting between different numeric data types. For example, suppose variable `x` is declared as `int` and `u` as unsigned. The expression `(unsigned) x` converts the value of `x` to an unsigned value, and `(int) u` converts the value of `u` to a signed integer. What should be the effect of casting signed value to unsigned, or vice versa? From a mathematical perspective, one can imagine several different conventions. Clearly, we want to preserve any value that can be represented in both forms. On the other hand, converting a negative value to unsigned might yield zero. Converting an unsigned value that is too large to be represented in two's-complement form might yield *TMax*. For most implementations of C, however, the answer to this question is based on a bit-level perspective, rather than on a numeric one.

For example, consider the following code:

```
1 short      int      v = -12345;
2 unsigned short uv = (unsigned short) v;
3 printf("v = %d, uv = %u\n", v, uv);
```

When run on a two's-complement machine, it generates the following output:

```
v = -12345, uv = 53191
```

What we see here is that the effect of casting is to keep the bit values identical but change how these bits are interpreted. We saw in [Figure 2.15](#) that the 16-bit two's-complement representation of  $-12,345$  is identical to the 16-bit unsigned representation of  $53,191$ . Casting from `short` to `unsigned short` changed the numeric value, but not the bit representation.

Similarly, consider the following code:

```
1 unsigned u = 4294967295u; /* UMax */
2 int tu = (int) u;
3 printf("u = %u, tu = %d\n", u, tu);
```

When run on a two's-complement machine, it generates the following output:

```
u = 4294967295, tu = -1
```

We can see from [Figure 2.14](#) that, for a 32-bit word size, the bit patterns representing 4,294,967,295 ( $UMax_{32}$ ) in unsigned form and  $-1$  in two's-complement form are identical. In casting from `unsigned` to `int`, the underlying bit representation stays the same.

This is a general rule for how most C implementations handle conversions between signed and unsigned numbers with the same word size—the numeric values might change, but the bit patterns do not. Let us capture this idea in a more mathematical form. We defined functions  $U2B_w$  and  $T2B_w$  that map numbers to their bit representations in either unsigned or two's-complement form. That is, given an integer  $x$  in the range  $0 \leq x < UMax_w$ , the function  $U2B_w(x)$  gives the unique  $w$ -bit unsigned representation of  $x$ . Similarly, when  $x$  is in the range  $TMin_w \leq x \leq TMax_w$ , the function  $T2B_w(x)$  gives the unique  $w$ -bit two's-complement representation of  $x$ .

Now define the function  $T2U_w$  as  $T2U_w(x) \doteq B2U_w(T2B_w(x))$ . This function takes a number between  $TMin_w$  and  $TMax_w$  and yields a number between 0 and  $UMax_w$ , where the two numbers have identical bit representations, except that the argument has a two's-complement representation while the result is unsigned. Similarly, for  $x$  between 0 and  $UMax_w$ , the function  $U2T_w$ , defined as  $U2T_w \doteq B2T_w(U2B_w(x))$ , yields the number having the same two's-complement representation as the unsigned representation of  $x$ .

Pursuing our earlier examples, we see from [Figure 2.15](#) that  $T2U_{16}(-12,345) = 53,191$ , and that  $U2T_{16}(53,191) = -12,345$ . That is, the 16-bit pattern written in hexadecimal as

`0xCFC7` is both the two's-complement representation of  $-12,345$  and the unsigned representation of  $53,191$ . Note also that  $12,345 + 53,191 = 65,536 = 2^{16}$ . This property generalizes to a relationship between the two numeric values (two's complement and unsigned) represented by a given bit pattern. Similarly, from [Figure 2.14](#), we see that  $T2U_{32}(-1) = 4,294,967,295$ , and  $U2T_{32}(4,294,967,295) = -1$ . That is,  $UMax$  has the same bit representation in unsigned form as does  $-1$  in two's-complement form. We can also see the relationship between these two numbers:  $1 + UMax_w = 2^w$ .

We see, then, that function  $T2U$  describes the conversion of a two's-complement number to its unsigned counterpart, while  $U2T$  converts in the opposite direction. These describe the effect of casting between these data types in most C implementations.

## Practice Problem 2.19 (solution page [149](#))

Using the table you filled in when solving [Problem 2.17](#), fill in the following table describing the function  $T2U_4$ :

The relationship we have seen, via several examples, between the two's-complement and unsigned values for a given bit pattern can be expressed as a property of the function  $T2U$ :

### Principle:

Conversion from two's complement to unsigned

For  $x$  such that  $TMin_w \leq x \leq TMax_w$ :

$$T2U_w(x) = \begin{cases} x + 2^w, & x < 0 \\ x, & x \geq 0 \end{cases} \quad (2.5)$$

For example, we saw that  $T2U_{16}(-12,345) = -12,345 + 2^{16} = 53,191$ , and also that  $T2U_w(-1) = -1 + 2^w = UMax_w$ .

This property can be derived by comparing [Equations 2.1](#) and [2.3](#).

## Derivation:

Conversion from two's complement to unsigned

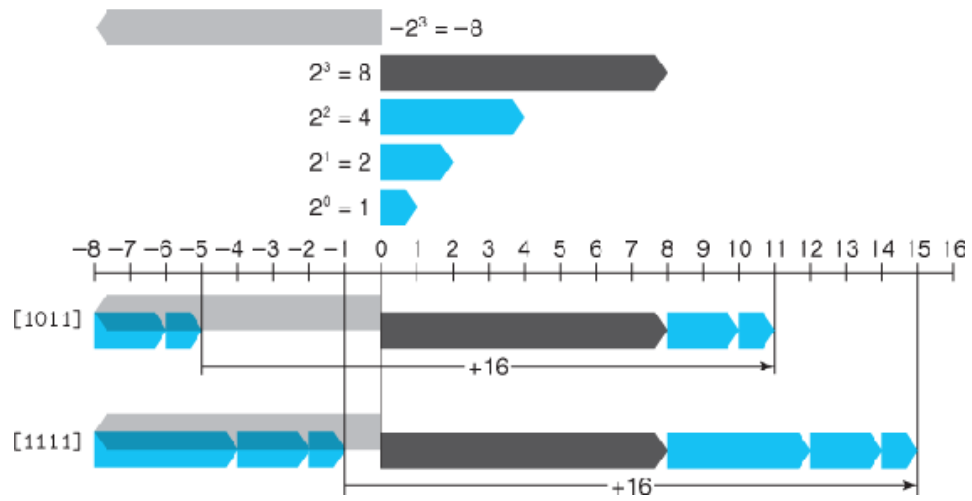
Comparing [Equations 2.1](#) and [2.3](#), we can see that for bit pattern  $\vec{x}$ , if we compute the difference  $B2U_w(\vec{x}) - B2T_w(\vec{x})$ , the weighted sums for bits from 0 to  $w-2$  will cancel each other, leaving a value

$B2U_w(\vec{x}) - B2T_w(\vec{x}) = x_{w-1}(2^{w-1} - -2^{w-1}) = x_{w-1}2^w$ . This gives a relationship  $B2U_w(\vec{x}) = B2T_w(\vec{x}) + x_{w-1}2^w$ . We therefore have

$$B2U_w(T2B_w(x)) = T2U_w(x) = x + x_{w-1}2^w \quad (2.6)$$

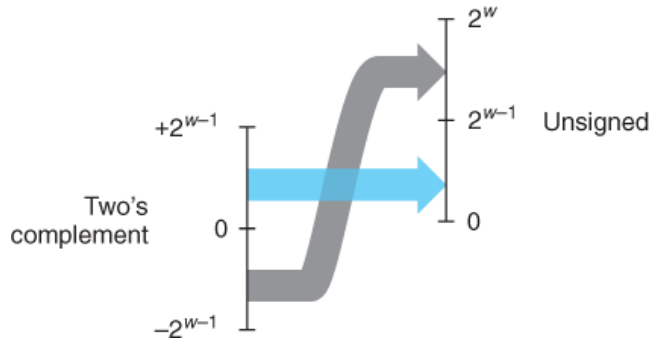
In a two's-complement representation of  $x$ , bit  $x_{w-1}$  determines whether or not  $x$  is negative, giving the two cases of [Equation 2.5](#).

As examples, [Figure 2.16](#) compares how functions  $B2U$  and  $B2T$  assign values to bit patterns for  $w = 4$ . For the two's-complement case, the most significant bit serves as the sign bit, which we diagram as a leftward-pointing gray bar. For the unsigned case, this bit has positive weight, which we show as a rightward-pointing black bar. In going from two's complement to unsigned, the most significant bit changes its weight from  $-8$  to  $+8$ . As a consequence, the values that are negative in a two's-complement representation increase by  $2^4 = 16$  with an unsigned representation. Thus,  $-5$  becomes  $+11$ , and  $-1$  becomes  $+15$ .





**Figure 2.16 Comparing unsigned and two's-complement representations for  $w = 4$ .** The weight of the most significant bit is  $-8$  for two's complement and  $+8$  for unsigned, yielding a net difference of 16.



**Figure 2.17 Conversion from two's complement to unsigned.** Function  $T2U$  converts negative numbers to large positive numbers.

**Figure 2.17** illustrates the general behavior of function  $T2U$ . As it shows, when mapping a signed number to its unsigned counterpart, negative numbers are converted to large positive numbers, while nonnegative numbers remain unchanged.

### Practice Problem 2.20 (solution page 149)

Explain how **Equation 2.5** applies to the entries in the table you generated when solving **Problem 2.19**.

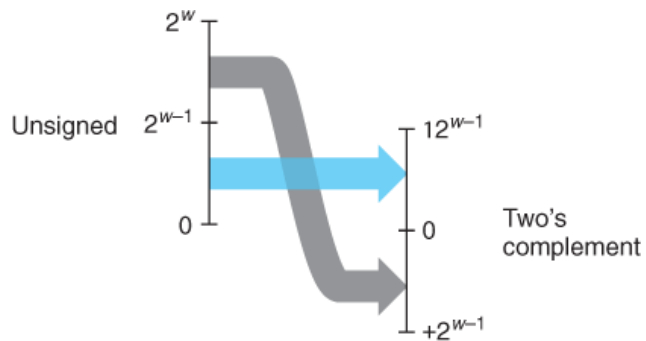
Going in the other direction, we can state the relationship between an unsigned number  $u$  and its signed counterpart  $U2T_w(u)$ :

## Principle:

Unsigned to two's-complement conversion

For  $u$  such that  $0 \leq u \leq UMax_w$ :

$$U2T_w(u) = \begin{cases} u, & u \leq TMax_w \\ u - 2^w, & u > TMax_w \end{cases} \quad (2.7)$$



**Figure 2.18 Conversion from unsigned to two's complement.**

Function  $U2T$  converts numbers greater than  $TMax_w = 2^{w-1} - 1$  to negative values.

This principle can be justified as follows:

## Derivation:

Unsigned to two's-complement conversion

Let  $\vec{u} = U2B_w(u)$ . This bit vector will also be the two's-complement representation of  $U2T_w(u)$ . [Equations 2.1](#) and [2.3](#) can be combined to give

$$U2T_w(u) = -u_{w-1}2^w + u \quad (2.8)$$

In the unsigned representation of  $u$ , bit  $u_{w-1}$  determines whether or not  $u$  is greater than  $TMax_w = 2^{w-1} - 1$ , giving the two cases of [Equation 2.7](#).

The behavior of function  $U2T$  is illustrated in [Figure 2.18](#). For small ( $\leq TMax_w$ ) numbers, the conversion from unsigned to signed preserves the numeric value. Large ( $> TMax_w$ ) numbers are converted to negative values.

To summarize, we considered the effects of converting in both directions between unsigned and two's-complement representations. For values  $x$  in the range  $0 \leq x \leq TMax_w$ , we have  $T2U_w(x) = x$  and  $U2T_w(x) = x$ . That is, numbers in this range have identical unsigned and two's-complement representations. For values outside of this range, the conversions either add or subtract  $2^w$ . For example, we have

$T2U_w(-1) = -1 + 2^w = UMax_w$ —the negative number closest to zero maps to the largest unsigned number. At the other extreme, one can see that

$T2U_w(TMin_w) = -2_w - 1 + 2^w = 2^{w-1} = TMax_w + 1$ —the most negative number maps to an unsigned number just outside the range of positive two's-complement numbers. Using the example of [Figure 2.15](#), we can see that

$$T2U_{16}(-12,345) = 65,536 + -12,345 = 53,191.$$

## 2.2.5 Signed versus Unsigned in C

As indicated in [Figures 2.9](#) and [2.10](#), C supports both signed and unsigned arithmetic for all of its integer data types. Although the C standard does not specify a particular representation of signed numbers, almost all machines use two's complement. Generally, most numbers are signed by default. For example, when declaring a constant such as `12345` or `0x1A2B`, the value is considered signed. Adding character `'U'` or `'u'` as a suffix creates an unsigned constant; for example, `12345U` or `0x1A2Bu`.

C allows conversion between unsigned and signed. Although the C standard does not specify precisely how this conversion should be made, most systems follow the rule that the underlying bit representation does not change. This rule has the effect of applying the function  $U2T_w$  when converting from unsigned to signed, and  $T2U_w$  when converting from signed to unsigned, where  $w$  is the number of bits for the data type.

Conversions can happen due to explicit casting, such as in the following code:

```
|  
1 int tx, ty;  
2 unsigned ux, uy;  
3  
4 tx = (int) ux;  
5 uy = (unsigned) ty;
```

Alternatively, they can happen implicitly when an expression of one type is assigned to a variable of another, as in the following code:

```
|  
1 int tx, ty;  
2 unsigned ux, uy;  
3  
4 tx = ux; /* Cast to signed */  
5 uy = ty; /* Cast to unsigned */
```

When printing numeric values with `printf`, the directives `%d`, `%u`, and `%x` are used to print a number as a signed decimal, an unsigned decimal, and in hexadecimal format, respectively. Note that `printf` does not make use of any type information, and so it is possible to print a value of type `int` with directive `%u` and a value of type `unsigned` with directive `%d`. For example, consider the following code:

```
1 int x = -1;
2 unsigned u = 2147483648; /* 2 to the 31st */
3
4 printf("x = %u = %d\n", x, x);
5 printf("u = %u = %d\n", u, u);
```

When compiled as a 32-bit program, it prints the following:

```
x = 4294967295 = -1
u = 2147483648 = -2147483648
```

In both cases, `printf` prints the word first as if it represented an unsigned number and second as if it represented a signed number. We can see the conversion routines in action:

$$T2U_{32}(-1) = UMax_{32} = 2^{32} - 1 \text{ and}$$
$$U2T_{32}(2^{31}) = 2^{31} - 2^{32} = -2^{31} = TMin_{32}.$$

Some possibly nonintuitive behavior arises due to C's handling of expressions containing combinations of signed and unsigned quantities. When an operation is performed where one operand is signed and the other is unsigned, C implicitly casts the signed argument to unsigned and performs the operations

### Figure 2.19 Effects of C promotion rules.

Nonintuitive cases are marked by ‘\*’. When either operand of a comparison is unsigned, the other operand is implicitly cast to unsigned. See Web Aside `DATA:TMIN` for why we write  $TMin_{32}$  as `-2,147,483,647-1`.

assuming the numbers are nonnegative. As we will see, this convention makes little difference for standard arithmetic operations, but it leads to nonintuitive results for relational operators such as `<` and `>`. Figure 2.19 shows some sample relational expressions and their resulting evaluations, when data type `int` has a 32-bit, two's-complement representation. Consider the comparison `-1 < 0U`. Since the second operand is unsigned, the first one is implicitly cast to unsigned, and hence the expression is equivalent to the comparison `4294967295U < 0U` (recall that  $T2U_w(-1) = UMax_w$ ), which of course is false. The other cases can be understood by similar analyses.

### Practice Problem 2.21 (solution page 149)

Assuming the expressions are evaluated when executing a 32-bit program on a machine that uses two's-complement arithmetic, fill in the following table describing the effect of casting and relational operations, in the style of Figure 2.19:

## 2.2.6 Expanding the Bit Representation of a Number

One common operation is to convert between integers having different word sizes while retaining the same numeric value. Of course, this may not be possible when the destination data type is too small to represent the desired value. Converting from a smaller to a larger data type, however, should always be possible.

### Web Aside DATA:TMIN Writing *TMin* in C

In [Figure 2.19](#) and in [Problem 2.21](#), we carefully wrote the value of  $TMin_{32}$  as `-2,147,483,647-1`. Why not simply write it as either `-2,147,483,648` or `0x80000000?` Looking at the C header file `limits.h`, we see that they use a similar method as we have to write  $TMin_{32}$  and  $TMax_{32}$ :

```
/* Minimum and maximum values a 'signed int' can hold. */
#define INT_MAX 2147483647
#define INT_MIN (-INT_MAX - 1)
```

Unfortunately, a curious interaction between the asymmetry of the two's-complement representation and the conversion rules of C forces us to write  $TMin_{32}$  in this unusual way. Although understanding this issue requires us to delve into one of the murkier corners of the C language standards, it will help us appreciate some of the subtleties of integer data types and representations.

To convert an unsigned number to a larger data type, we can simply add leading zeros to the representation; this operation is known as *zero extension*, expressed by the following principle:

## Principle:

Expansion of an unsigned number by zero extension

Define bit vectors  $\vec{u} = [u_{w-1}, u_{w-1}, \dots, u_0]$  of width  $w$  and  $\vec{u'} = [0, \dots, 0, u_{w-1}, u_{w-2}, \dots, u_0]$  of width  $w'$ , where  $w' > w$ . Then  $B2U_w(\vec{u}) = B2U_{w'}(\vec{u'})$ .

This principle can be seen to follow directly from the definition of the unsigned encoding, given by [Equation 2.1](#).

For converting a two's-complement number to a larger data type, the rule is to perform a *sign extension*, adding copies of the most significant bit to the representation, expressed by the following principle. We show the sign bit  $x_{w-1}$  in blue to highlight its role in sign extension.

## Principle:

Expansion of a two's-complement number by sign extension

Define bit vectors  $\vec{x} = [x_{w-1}, x_{w-2}, \dots, x_0]$  of width  $w$  and  $\vec{x'} = [x_{w-1}, \dots, x_{w-1}, x_{w-1}, x_{w-2}, \dots, x_0]$  of width  $w'$ , where  $w' > w$ . Then  $B2T_w(\vec{x}) = B2T_{w'}(\vec{x'})$ .

As an example, consider the following code:



```

1 short sx = -12345;      /* -12345 */
2 unsigned short usx = sx; /* 53191 */
3 int x = sx;             /* -12345 */
4 unsigned ux = usx;      /* 53191 */
5
6 printf("sx = %d:\t", sx);
7 show_bytes((byte_pointer) "sx, sizeof(short));
8 printf("usx = %u:\t", usx);
9 show_bytes((byte_pointer) "usx, sizeof(unsigned short));
10 printf("x = %d:\t", x);
11 show_bytes((byte_pointer) &x, sizeof(int));
12 printf("ux = %u:\t", ux);
13 show_bytes((byte_pointer) &ux, sizeof(unsigned));

```

When run as a 32-bit program on a big-endian machine that uses a two's-complement representation, this code prints the output

```

sx = -12345:    cf c7
usx = 53191:    cf c7
x = -12345:    ff ff cf c7
ux = 53191:    00 00 cf c7

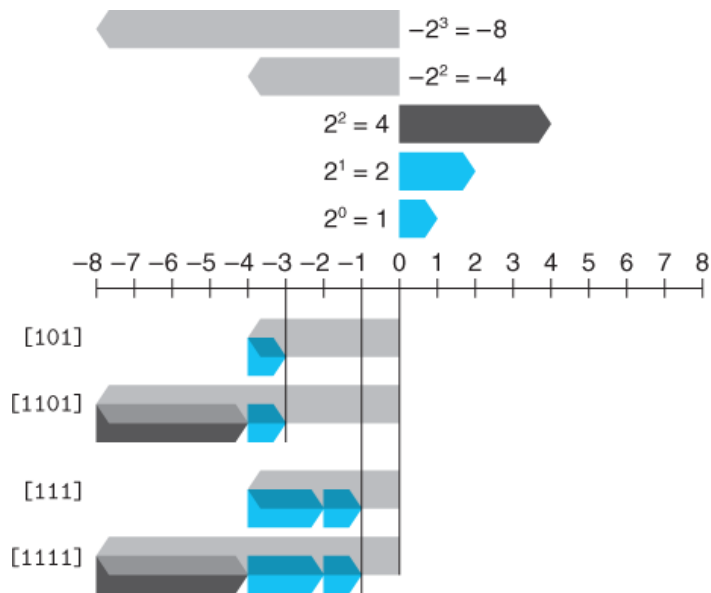
```

We see that, although the two's-complement representation of  $-12,345$  and the unsigned representation of  $53,191$  are identical for a 16-bit word size, they differ for a 32-bit word size. In particular,  $-12,345$  has hexadecimal representation `0xFFFFCFC7`, while  $53,191$  has hexadecimal representation `0x0000CFC7`. The former has been sign extended—16 copies of the most significant bit 1, having hexadecimal representation `0xFFFF`, have been added as leading bits. The latter has been extended with 16 leading zeros, having hexadecimal representation `0x0000`.

As an illustration, [Figure 2.20](#) shows the result of expanding from word size  $w = 3$  to  $w = 4$  by sign extension. Bit vector `[101]` represents the value  $-4 + 1 = -3$ . Applying sign extension gives bit vector `[1101]` representing the value  $-8 + 4 + 1 = -3$ . We can see that,

for  $w = 4$ , the combined value of the two most significant bits,  $-8 + 4 = -4$ , matches the value of the sign bit for  $w = 3$ . Similarly, bit vectors **[111]** and [1111] both represent the value  $-1$ .

With this as intuition, we can now show that sign extension preserves the value of a two's-complement number.



**Figure 2.20** Examples of sign extension from  $w = 3$  to  $w = 4$ .

For  $w = 4$ , the combined weight of the upper 2 bits is  $-8 + 4 = -4$ , matching that of the sign bit for  $w = 3$ .

## Derivation:

Expansion of a two's-complement number by sign extension Let  $w' = w + k$ .

What we want to prove is that

$$B2T_{w+k}(\underbrace{[x_{w-1}, \dots, x_{w-1}]_{k \text{ times}}, x_{w-2}, \dots, x_0]) = B2T_w([x_{w-1}, x_{w-2}, \dots, x_0])$$

The proof follows by induction on  $k$ . That is, if we can prove that sign extending by 1 bit preserves the numeric value, then this property will hold when sign extending by an arbitrary number of bits. Thus, the task reduces to proving that

$$B2T_{w+1}([x_{w-1}, x_{w-1}, x_{w-2}, \dots, x_0]) = B2T_w([x_{w-1}, x_{w-2}, \dots, x_0])$$

Expanding the left-hand expression with [Equation 2.3](#) gives the following:

$$\begin{aligned} B2T_{w+1}([x_{w-1}, x_{w-1}, x_{w-2}, \dots, x_0]) &= -x_{w-1}2^w + \sum_{i=0}^{w-1} x_i 2^i \\ &= -x_{w-1}2^w + x_{w-1}2^{w-1} + \sum_{i=0}^{w-2} x_i 2^i \\ &= -x_{w-1}(2^w - 2^{w-1}) + \sum_{i=0}^{w-2} x_i 2^i \\ &= -x_{w-1}2^{w-1} + \sum_{i=0}^{w-2} x_i 2^i \\ &= B2T_w([x_{w-1}, x_{w-2}, \dots, x_0]) \end{aligned}$$

The key property we exploit is that  $2^w - 2^{w-1} = 2^{w-1}$ . Thus, the combined effect of adding a bit of weight  $-2^w$  and of converting the bit having weight  $-2^{w-1}$  to be one with weight  $2^{w-1}$  is to preserve the original numeric value.

## Practice Problem 2.22 (solution page 150)

Show that each of the following bit vectors is a two's-complement representation of  $-5$  by applying [Equation 2.3](#):

- A. [1011]
- B. [11011]
- C. [111011]

Observe that the second and third bit vectors can be derived from the first by sign extension.

One point worth making is that the relative order of conversion from one data size to another and between unsigned and signed can affect the behavior of a program. Consider the following code:

```
1 short sx = -12345; /* -12345 */
2 unsigned uy = sx; /* Mystery! */
3
4 printf("uy = %u:\t", uy);
5 show_bytes((byte_pointer) &uy, sizeof(unsigned));
```

When run on a big-endian machine, this code causes the following output to be printed:

```
uy = 4294954951: ff ff cf c7
```

This shows that, when converting from `short` to `unsigned`, the program first changes the size and then the type. That is, `(unsigned) sx` is equivalent to `(unsigned) (int) sx`, evaluating to 4,294,954,951, not `(unsigned) (unsigned short) sx`, which evaluates to 53,191. Indeed, this convention is required by the C standards.

## Practice Problem 2.23 (solution page [150](#))

Consider the following C functions:

```
|
int fun1(unsigned word) {
    return (int) ((word << 24) >> 24);
}

int fun2(unsigned word) {
    return ((int) word << 24) >> 24;
}
```

Assume these are executed as a 32-bit program on a machine that uses two's-complement arithmetic. Assume also that right shifts of signed values are performed arithmetically, while right shifts of unsigned values are performed logically.

- A. Fill in the following table showing the effect of these functions for several example arguments. You will find it more convenient to work with a hexadecimal representation. Just remember that hex digits 8 through F have their most significant bits equal to 1.
- B. Describe in words the useful computation each of these functions performs.

## 2.2.7 Truncating Numbers

Suppose that, rather than extending a value with extra bits, we reduce the number of bits representing a number. This occurs, for example, in the following code:

```
1 int x = 53191;
2 short sx = (short) x; /* -12345 */
3 int y = sx; /* -12345 */
```

Casting `x` to be `short` will truncate a 32-bit `int` to a 16-bit `short`. As we saw before, this 16-bit pattern is the two's-complement representation of  $-12,345$ . When casting this back to `int`, sign extension will set the high-order 16 bits to ones, yielding the 32-bit two's-complement representation of  $-12,345$ .

When truncating a  $w$ -bit number  $\vec{x} = [x_{w-1}, x_{w-2}, \dots, x_0]$  to a  $k$ -bit number, we drop the high-order  $w - k$  bits, giving a bit vector  $\vec{x}' = [x_{k-1}, x_{k-2}, \dots, x_0]$ . Truncating a number can alter its value—a form of overflow. For an unsigned number, we can readily characterize the numeric value that will result.

### Principle:

Truncation of an unsigned number

Let  $\vec{x}$  be the bit vector  $[x_{w-1}, x_{w-2}, \dots, x_0]$ , and let  $\vec{x}'$  be the result of truncating it to  $k$  bits:  $\vec{x}' = [x_{k-1}, x_{k-2}, \dots, x_0]$ . Let  $x = B2U_w(\vec{x})$  and  $x' = B2U_k(\vec{x}')$ . Then  $x' = x \bmod 2^k$ .

The intuition behind this principle is simply that all of the bits that were truncated have weights of the form  $2^i$ , where  $i \geq k$ , and therefore each of these weights reduces to zero under the modulus operation. This is formalized by the following derivation:

## Derivation:

Truncation of an unsigned number

Applying the modulus operation to [Equation 2.1](#) yields

$$\begin{aligned} B2U_w([x_{w-1}, x_{w-2}, \dots, x_0]) \bmod 2^k &= \left[ \sum_{i=0}^{w-1} x_i 2^i \right] \bmod 2^k \\ &= \left[ \sum_{i=0}^{k-1} x_i 2^i \right] \bmod 2^k \\ &= \sum_{i=0}^{k-1} x_i 2^i \\ &= B2U_k([x_{k-1}, x_{k-2}, \dots, x_0]) \end{aligned}$$

In this derivation, we make use of the property that  $2^i \bmod 2^k = 0$  for any  $i \geq k$ .

A similar property holds for truncating a two's-complement number, except that it then converts the most significant bit into a sign bit:

## Principle:

Truncation of a two's-complement number

Let  $\vec{x}$  be the bit vector  $[x_{w-1}, x_{w-2}, \dots, x_0]$ , and let  $\vec{x}'$  be the result of truncating it to  $k$  bits:  $\vec{x}' = [x_{k-1}, x_{k-2}, \dots, x_0]$ . Let  $x = B2T_w(\vec{x})$  and  $x' = B2T_k(\vec{x}')$ . Then  $x' = U2T_k(x \bmod 2^k)$ .

In this formulation,  $x \bmod 2^k$  will be a number between 0 and  $2^k - 1$ . Applying function  $U2T_k$  to it will have the effect of converting the most significant bit  $x_{k-1}$  from having weight  $2^{k-1}$  to having weight  $-2^{k-1}$ . We can see this with the example of converting value  $x = 53,191$  from *int* to *short*. Since  $2^{16} = 65,536 \geq x$ , we have  $x \bmod 2^{16} = x$ . But when we convert this number to a 16-bit two's-complement number, we get  $x' = 53,191 - 65,536 = -12,345$ .

## Derivation:

Truncation of a two's-complement number

Using a similar argument to the one we used for truncation of an unsigned number shows that

$$B2T_w([x_{w-1}, x_{w-2}, \dots, x_0]) \bmod 2^k = B2U_k([x_{k-1}, x_{k-2}, \dots, x_0])$$

That is,  $x \bmod 2^k$  can be represented by an unsigned number having bit-level representation  $[x_{k-1}, x_{k-2}, \dots, x_0]$ . Converting this to a two's-complement number gives  $x' = U2T_k(x \bmod 2^k)$ .



Summarizing, the effect of truncation for unsigned numbers is

$$B2U_k([x_{k-1}, x_{k-2}, \dots, x_0]) = B2U_w([x_{w-1}, x_{w-2}, \dots, x_0]) \bmod 2^k \quad (2.9)$$

while the effect for two's-complement numbers is

$$B2T_k([x_{k-1}, x_{k-2}, \dots, x_0]) = B2U_w(B2U_w([x_{w-1}, x_{w-2}, \dots, x_0]) \bmod 2^k) \quad (2.10)$$

### *Practice Problem 2.24 (solution page [150](#))*

Suppose we truncate a 4-bit value (represented by hex digits [0](#) through [F](#)) to a 3-bit value (represented as hex digits [0](#) through [7](#).) Fill in the table below showing the effect of this truncation for some cases, in terms of the unsigned and two's-complement interpretations of those bit patterns.

Explain how [Equations 2.9](#) and [2.10](#) apply to these cases.

## 2.2.8 Advice on Signed versus Unsigned

As we have seen, the implicit casting of signed to unsigned leads to some nonintuitive behavior. Nonintuitive features often lead to program bugs, and ones involving the nuances of implicit casting can be especially difficult to see. Since the casting takes place without any clear indication in the code, programmers often overlook its effects.

The following two practice problems illustrate some of the subtle errors that can arise due to implicit casting and the unsigned data type.

### *Practice Problem 2.25 (solution page [151](#))*

Consider the following code that attempts to sum the elements of an array `a`, where the number of elements is given by parameter `length`:

```
1  /* WARNING: This is buggy code */
2  float sum_elements(float a[], unsigned length) {
3      int i;
4      float result = 0;
5
6      for (i = 0; i <= length-1; i++)
7          result += a[i];
8      return result;
9  }
```

When run with argument `length` equal to 0, this code should return 0.0. Instead, it encounters a memory error. Explain why this happens. Show how this code can be corrected.

## Practice Problem 2.26 (solution page [151](#))

You are given the assignment of writing a function that determines whether one string is longer than another. You decide to make use of the string library function `strlen` having the following declaration:

```
|  
/* Prototype for library function strlen */  
size_t strlen(const char *s);
```

Here is your first attempt at the function:

```
|  
/* Determine whether string s is longer than string t */  
/* WARNING: This function is buggy */  
int strlonger(char *s, char *t) {  
    return strlen(s) - strlen(t) > 0;  
}
```

When you test this on some sample data, things do not seem to work quite right. You investigate further and determine that, when compiled as a 32-bit program, data type `size_t` is defined (via `typedef`) in header file `stdio.h` to be `unsigned`.

- For what cases will this function produce an incorrect result?
- Explain how this incorrect result comes about.
- Show how to fix the code so that it will work reliably.

We have seen multiple ways in which the subtle features of unsigned arithmetic, and especially the implicit conversion of signed to unsigned, can lead to errors or vulnerabilities. One way to avoid such bugs is to never use unsigned numbers. In fact, few languages other than C support unsigned integers. Apparently, these other language designers viewed them as more trouble than they are worth. For example, Java supports only signed integers, and it requires that they be implemented with two's-complement arithmetic. The normal right shift operator `>>` is guaranteed to perform an arithmetic shift. The special operator `>>>` is defined to perform a logical right shift.

Unsigned values are very useful when we want to think of words as just collections of bits with no numeric interpretation. This occurs, for example, when packing a word with *flags*


describing various Boolean conditions. Addresses are naturally unsigned, so systems programmers find unsigned types to be helpful. Unsigned values are also useful when implementing mathematical packages for modular arithmetic and for multiprecision arithmetic, in which numbers are represented by arrays of words.

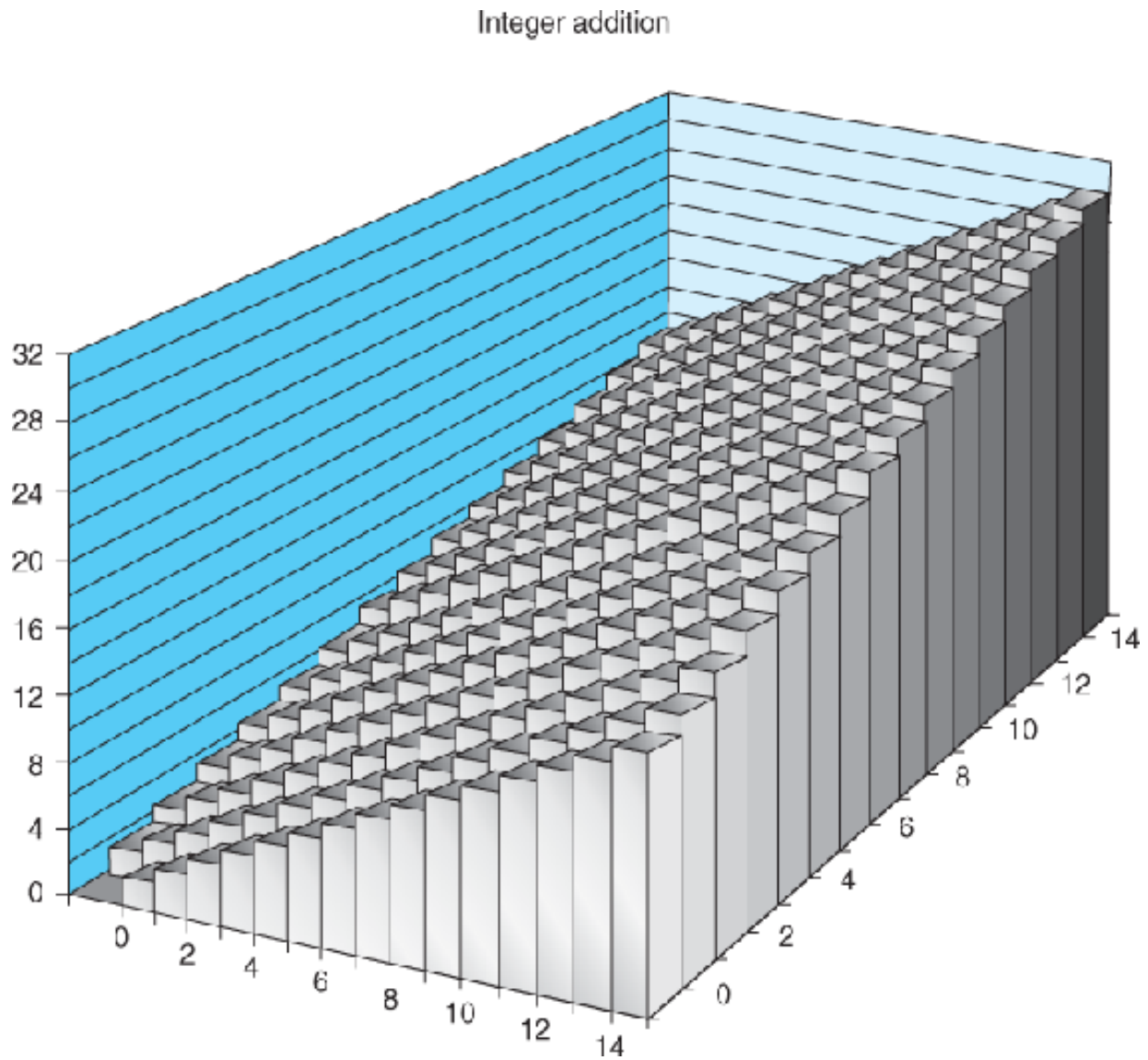
[OceanofPDF.com](http://OceanofPDF.com)

## 2.3 Integer Arithmetic

Many beginning programmers are surprised to find that adding two positive numbers can yield a negative result, and that the comparison `x < y` can yield a different result than the comparison `x-y < 0`. These properties are artifacts of the finite nature of computer arithmetic. Understanding the nuances of computer arithmetic can help programmers write more reliable code.

## 2.3.1 Unsigned Addition

Consider two nonnegative integers  $x$  and  $y$ , such that  $0 \leq x, y < 2^w$ . Each of these values can be represented by a  $w$ -bit unsigned number. If we compute their sum, however, we have a possible range  $0 \leq x + y \leq 2^{w+1} - 2$ . Representing this sum could require  $w + 1$  bits. For example, [Figure 2.21](#)  shows a plot of the function  $x + y$  when  $x$  and  $y$  have 4-bit representations. The arguments (shown on the horizontal axes) range from 0 to 15, but the sum ranges from 0 to 30. The shape of the function is a sloping plane (the function is linear in both dimensions). If we were to maintain the sum as a  $(w + 1)$ -bit number and add it to another value, we may require  $w + 2$  bits, and so on. This continued “word size



**Figure 2.21 Integer addition.**

With a 4-bit word size, the sum could require 5 bits.

inflation” means we cannot place any bound on the word size required to fully represent the results of arithmetic operations. Some programming languages, such as Lisp, actually support *arbitrary size* arithmetic to allow integers of any size (within the memory limits of the computer, of course.) More commonly, programming languages support fixed-size arithmetic, and hence operations such as “addition” and “multiplication” differ from their counterpart operations over integers.

Let us define the operation  $+_w^u$  for arguments  $x$  and  $y$ , where  $0 \leq x, y < 2^w$ , as the result of truncating the integer sum  $x + y$  to be  $w$  bits long and then viewing the result as an unsigned number. This can be characterized as a form of modular arithmetic, computing the sum modulo  $2^w$  by simply discarding any bits with weight greater than  $2^{w-1}$  in the bit-level representation of  $x + y$ . For example, consider a 4-bit number representation with  $x = 9$  and  $y = 12$ , having bit representations [1001] and [1100], respectively. Their sum is 21, having a 5-bit representation [10101]. But if we discard the high-order bit, we get [0101], that is, decimal value 5. This matches the value  $21 \bmod 16 = 5$ .



# Aside Security vulnerability in

## `getpeername`

In 2002, programmers involved in the FreeBSD open-source operating systems project realized that their implementation of the `getpeername` library function had a security vulnerability. A simplified version of their code went something like this:

```

1      /*
2      * Illustration of code vulnerability similar to that
found in
3      * FreeBSD's implementation of getpeername()
4      */
5
6      /* Declaration of library function memcpy */
7      void *memcpy(void *dest, void *src, size_t n);
8
9      /* Kernel memory region holding user-accessible data */
10     #define KSIZE 1024
11     char kbuf[KSIZE];
12
13     /* Copy at most maxlen bytes from kernel region to user
buffer */
14     int copy_from_kernel(void *user_dest, int maxlen) {
15         /* Byte count len is minimum of buffer size and
maxlen */
16         int len = KSIZE < maxlen ? KSIZE : maxlen;
17         memcpy(user_dest, kbuf, len);
18         return len;
19     }

```

In this code, we show the prototype for library function `memcpy` on line 7, which is designed to copy a specified number of bytes `n` from one region of memory to another.

The function `copy_from_kernel`, starting at line 14, is designed to copy some of the data maintained by the operating system kernel to a

designated region of memory accessible to the user. Most of the data structures maintained by the kernel should not be readable by a user, since they may contain sensitive information about other users and about other jobs running on the system, but the region shown as `kbuf` was intended to be one that the user could read. The parameter `maxlen` is intended to be the length of the buffer allocated by the user and indicated by argument `user_dest`. The computation at line 16 then makes sure that no more bytes are copied than are available in either the source or the destination buffer.

Suppose, however, that some malicious programmer writes code that calls `copy_from_kernel` with a negative value of `maxlen`. Then the minimum computation on line 16 will compute this value for `len`, which will then be passed as the parameter `n` to `memcpy`. Note, however, that parameter `n` is declared as having data type `size_t`. This data type is declared (via `typedef`) in the library file `stdio.h`. Typically, it is defined to be `unsigned` for 32-bit programs and `unsigned long` for 64-bit programs. Since argument `n` is unsigned, `memcpy` will treat it as a very large positive number and attempt to copy that many bytes from the kernel region to the user's buffer. Copying that many bytes (at least  $2^{31}$ ) will not actually work, because the program will encounter invalid addresses in the process, but the program could read regions of the kernel memory for which it is not authorized.

We can see that this problem arises due to the mismatch between data types: in one place the length parameter is signed; in another place it is unsigned. Such mismatches can be a source of bugs and, as this example shows, can even lead to security vulnerabilities. Fortunately, there were no reported cases where a programmer had exploited the vulnerability in FreeBSD. They issued a security

advisory “FreeBSD-SA-02:38.signed-error” advising system administrators on how to apply a patch that would remove the vulnerability. The bug can be fixed by declaring parameter `maxlen` to `copy_from_kernel` to be of type `size_t`, to be consistent with parameter `n` of `memcpy`. We should also declare local variable `len` and the return value to be of type `size_t`.

We can characterize operation  $+_w^u$  as follows:

## Principle:

Unsigned addition

For  $x$  and  $y$  such that  $0 \leq x, y < 2^w$ :

$$x +_w^u y = \begin{cases} x + y, & x + y < 2^w \text{ Normal} \\ x + y - 2^w, & 2^w \leq x + y < 2^{w+1} \text{ Overflow} \end{cases} \quad (2.11)$$

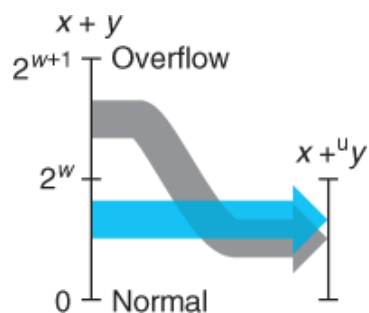
The two cases of [Equation 2.11](#) are illustrated in [Figure 2.22](#), showing the sum  $x + y$  on the left mapping to the unsigned  $w$ -bit sum  $x +_w^u y$  on the right. The normal case preserves the value of  $x + y$ , while the overflow case has the effect of decrementing this sum by  $2^w$ .

## Derivation:

### Unsigned addition

In general, we can see that if  $x + y < 2^w$ , the leading bit in the  $(w + 1)$ -bit representation of the sum will equal 0, and hence discarding it will not change the numeric value. On the other hand, if  $2^w \leq x + y < 2^{w+1}$ , the leading bit in the  $(w + 1)$ -bit representation of the sum will equal 1, and hence discarding it is equivalent to subtracting  $2^w$  from the sum.

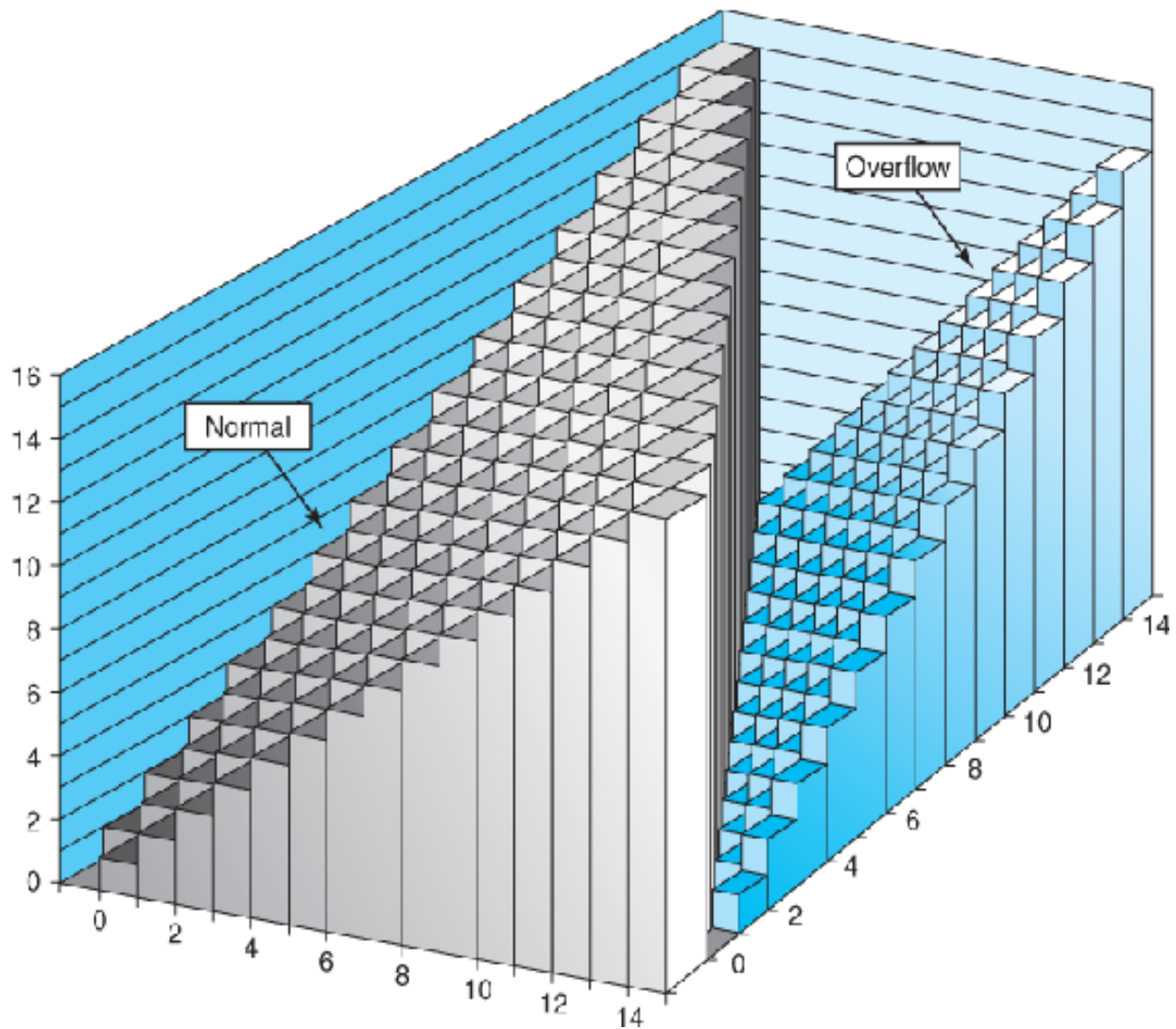
An arithmetic operation is said to *overflow* when the full integer result cannot fit within the word size limits of the data type. As [Equation 2.11](#) indicates, overflow



**Figure 2.22 Relation between integer addition and unsigned addition.**

When  $x + y$  is greater than  $2^w - 1$ , the sum overflows.

Unsigned addition (4-bit word)



**Figure 2.23** Unsigned addition.

With a 4-bit word size, addition is performed modulo 16.

occurs when the two operands sum to  $2^w$  or more. [Figure 2.23](#) shows a plot of the unsigned addition function for word size  $w = 4$ . The sum is computed modulo  $2^4 = 16$ . When  $x + y < 16$ , there is no overflow, and  $x +_4^u y$  is simply  $x + y$ . This is shown as the region forming a sloping plane labeled "Normal." When  $x + y \geq 16$ , the addition overflows, having the effect

of decrementing the sum by 16. This is shown as the region forming a sloping plane labeled “Overflow.”

When executing C programs, overflows are not signaled as errors. At times, however, we might wish to determine whether or not overflow has occurred.

## Principle:

Detecting overflow of unsigned addition

For  $x$  and  $y$  in the range  $0 \leq x, y \leq UMax_w$ , let  $s \doteq x +_w^u y$ . Then the computation of  $s$  overflowed if and only if  $s < x$  (or equivalently,  $s < y$ ).

As an illustration, in our earlier example, we saw that  $9 +_4^u 12 = 5$ . We can see that overflow occurred, since  $5 < 9$ .

## Derivation:

Detecting overflow of unsigned addition

Observe that  $x + y \geq x$ , and hence if  $s$  did not overflow, we will surely have  $s \geq x$ . On the other hand, if  $s$  did overflow, we have  $s = x + y - 2^w$ . Given that  $y < 2^w$ , we have  $y - 2^w < 0$ , and hence  $s = x + (y - 2^w) < x$ .

## Practice Problem 2.27 (solution page [152](#))

Write a function with the following prototype:

```
/* Determine whether arguments can be added without overflow */  
int uadd_ok(unsigned x, unsigned y);
```

This function should return 1 if arguments `x` and `y` can be added without causing overflow.

Modular addition forms a mathematical structure known as an *abelian group*, named after the Norwegian mathematician Niels Henrik Abel (1802–1829). That is, it is commutative (that's where the “abelian” part comes in) and associative; it has an identity element 0, and every element has an additive inverse. Let us consider the set of  $w$ -bit unsigned numbers with addition operation  $+_w^u$ . For every value  $x$ , there must be some value  $-_w^u x$  such that



$-^u_w x + ^u_w x = 0$ . This additive inverse operation can be characterized as follows:

## Principle:

Unsigned negation

For any number  $x$  such that  $0 \leq x < 2^w$ , its  $w$ -bit unsigned negation  $-^u_w x$  is given by the following:

$$-^u_w x = \begin{cases} x, & x = 0 \\ 2^w - x, & x > 0 \end{cases} \quad (2.12)$$

This result can readily be derived by case analysis:

## Derivation:

Unsigned negation

When  $x = 0$ , the additive inverse is clearly 0. For  $x > 0$ , consider the value  $2^w - x$ . Observe that this number is in the range  $0 < 2^w - x < 2^w$ . We can also see that  $(x + 2^w - x) \bmod 2^w = 2^w \bmod 2^w = 0$ . Hence it is the inverse of  $x$  under  $+_w^u$ .

### *Practice Problem 2.28 (solution page [152](#))*

We can represent a bit pattern of length  $w = 4$  with a single hex digit. For an unsigned interpretation of these digits, use [Equation 2.12](#) to fill in the following table giving the values and the bit representations (in hex) of the unsigned additive inverses of the digits shown.

## 2.3.2 Two's-Complement Addition

With two's-complement addition, we must decide what to do when the result is either too large (positive) or too small (negative) to represent. Given integer values  $x$  and  $y$  in the range  $-2^{w-1} \leq x, y \leq 2^{w-1} - 1$ , their sum is in the range  $-2^w \leq x + y \leq 2^{w-1} - 2$ , potentially requiring  $w + 1$  bits to represent exactly. As before, we avoid ever-expanding data sizes by truncating the representation to  $w$  bits. The result is not as familiar mathematically as modular addition, however. Let us define  $x +_w^t y$  to be the result of truncating the integer sum  $x + y$  to be  $w$  bits long and then viewing the result as a two's-complement number.

### Principle:

Two's-complement addition

For integer values  $x$  and  $y$  in the range

$$-2^{w-1} \leq x, y \leq 2^{w-1} - 1 :$$

$$x +_w^t y = \begin{cases} x + y - 2^w, & 2^{w-1} \leq x + y & \text{Positive overflow} \\ x + y, & -2^{w-1} \leq x + y < 2^{w-1} & \text{Normal} \\ x + y + 2^w, & x + y < -2^{w-1} & \text{Negative overflow} \end{cases}$$

This principle is illustrated in [Figure 2.24](#)

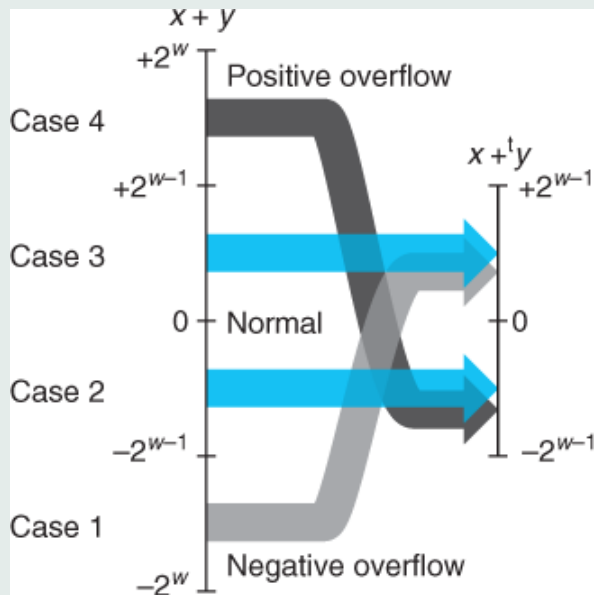
on the right. (The labels “Case 1” to “Case 4” in this figure are for the case analysis of the formal derivation of the principle.) When the sum  $x + y$  exceeds  $TMax_w$  (Case 4), we say that *positive overflow* has occurred. In this case, the effect of truncation is to subtract  $2^w$  from the sum. When the sum  $x + y$  is less than  $TMin_w$  (Case 1), we say that *negative overflow* has occurred. In this case, the effect of truncation is to add  $2^w$  to the sum.

The  $w$ -bit two's-complement sum of two numbers has the exact same bit-level representation as the unsigned sum. In fact, most computers use the same machine instruction to perform either unsigned or signed addition.

## Derivation:

### Two's-complement addition

Since two's-complement addition has the exact same bit-level representation as unsigned addition, we can characterize the operation  $+_w^t$  as one of converting its arguments to unsigned, performing unsigned addition, and then converting back to two's complement:



**Figure 2.24 Relation between integer and two's-complement addition.**

When  $x + y$  is less than  $-2^{w-1}$ , there is a negative overflow. When it is greater than or equal to  $2^{w-1}$ , there is a positive overflow.

$$x +_w^t y = U2T_w (T2U_w (x) +_w^u T2U_w (y))$$

By [Equation 2.6](#), we can write  $T2U_w(x)$  as  $x_{w-1}2^w$  and  $T2U_w(y)$  as  $y_{w-1}2^w + y$ . Using the property that  $+_w^u$  is simply addition modulo  $2^w$ , along with the properties of modular addition, we then have

$$\begin{aligned} x +_w^t y &= U2T_w(T2U_w(x) +_w^u T2U_w(y)) \\ &= U2T_w[(x_{w-1}2^w + x + y_{w-1}2^w + y) \bmod 2^w] \\ &= U2T_w[(x + y) \bmod 2^w] \end{aligned}$$

The terms  $x_{w-1}2^w$  and  $y_{w-1}2^w$  drop out since they equal 0 modulo  $2^w$ .

To better understand this quantity, let us define  $z$  as the integer sum  $z \doteq x + y$ ,  $z'$  as  $z' \doteq z \bmod 2^w$ , and  $z''$  as  $z'' \doteq U2T_w(z')$ . The value  $z''$  is equal to  $x +_w^t y$ . We can divide the analysis into four cases as illustrated in [Figure 2.24](#):

1.  $-2^w \leq z < -2^w - 1$ . Then we will have  $z' = z + 2^w$ . This gives  $0 \leq z' < -2^{w-1} + 2^w = 2^{w-1}$ . Examining [Equation 2.7](#), we see that  $z'$  is in the range such that  $z'' = z'$ . This is the case of negative overflow. We have added two negative numbers  $x$  and  $y$  (that's the only way we can have  $z < -2^{w-1}$ ) and obtained a nonnegative result  $z'' = x + y + 2^w$ .
2.  $-2^{w-1} \leq z < 0$ . Then we will again have  $z' = z + 2^w$ , giving  $-2^{w-1} + 2^w = 2^{w-1} \leq z' < 2^w$ . Examining [Equation 2.7](#), we see that  $z'$  is in such a range that  $z'' = z' - 2^w$ , and therefore  $z'' = z' - 2^w = z + 2^w - 2^w = z$ . That is, our two's-complement sum  $z''$  equals the integer sum  $x + y$ .

3.  $0 \leq z < 2^{w-1}$ . Then we will have  $z' = z$ , giving  $0 \leq z' < 2^{w-1}$ , and hence  $z'' = z' = z$ . Again, the two's-complement sum  $z''$  equals the integer sum  $x + y$ .
4.  $2^{w-1} \leq z < 2^w$ . We will again have  $z' = z$ , giving  $2^{w-1} \leq z' < 2^w$ . But in this range we have  $z'' = z' - 2^w$ , giving  $z'' = x + y - 2^w$ . This is the case of positive overflow. We have added two positive numbers  $x$  and  $y$  (that's the only way we can have  $z \geq 2^{w-1}$ ) and obtained a negative result  $z'' = x + y - 2^w$ .


**Figure 2.25 Two's-complement addition examples.**

The bit-level representation of the 4-bit two's-complement sum can be obtained by performing binary addition of the operands and truncating the result to 4 bits.

As illustrations of two's-complement addition, [Figure 2.25](#) shows some examples when  $w = 4$ . Each example is labeled by the case to which it corresponds in the derivation of [Equation 2.13](#). Note that  $2^4 = 16$ , and hence negative overflow yields a result 16 more than the integer sum, and positive overflow yields a result 16 less. We include bit-level representations of the operands and the result. Observe that the result can be obtained by performing binary addition of the operands and truncating the result to 4 bits.

[Figure 2.26](#) illustrates two's-complement addition for word size  $w = 4$ . The operands range between  $-8$  and  $7$ . When  $x + y < -8$ , two's-complement addition has a negative overflow, causing the sum to be incremented by 16. When  $-8 \leq x + y < 8$ , the addition yields  $x + y$ . When  $x + y \geq 8$ , the addition


has a positive overflow, causing the sum to be decremented by 16. Each of these three ranges forms a sloping plane in the figure.

**Equation 2.13**  also lets us identify the cases where overflow has occurred:

## Principle:

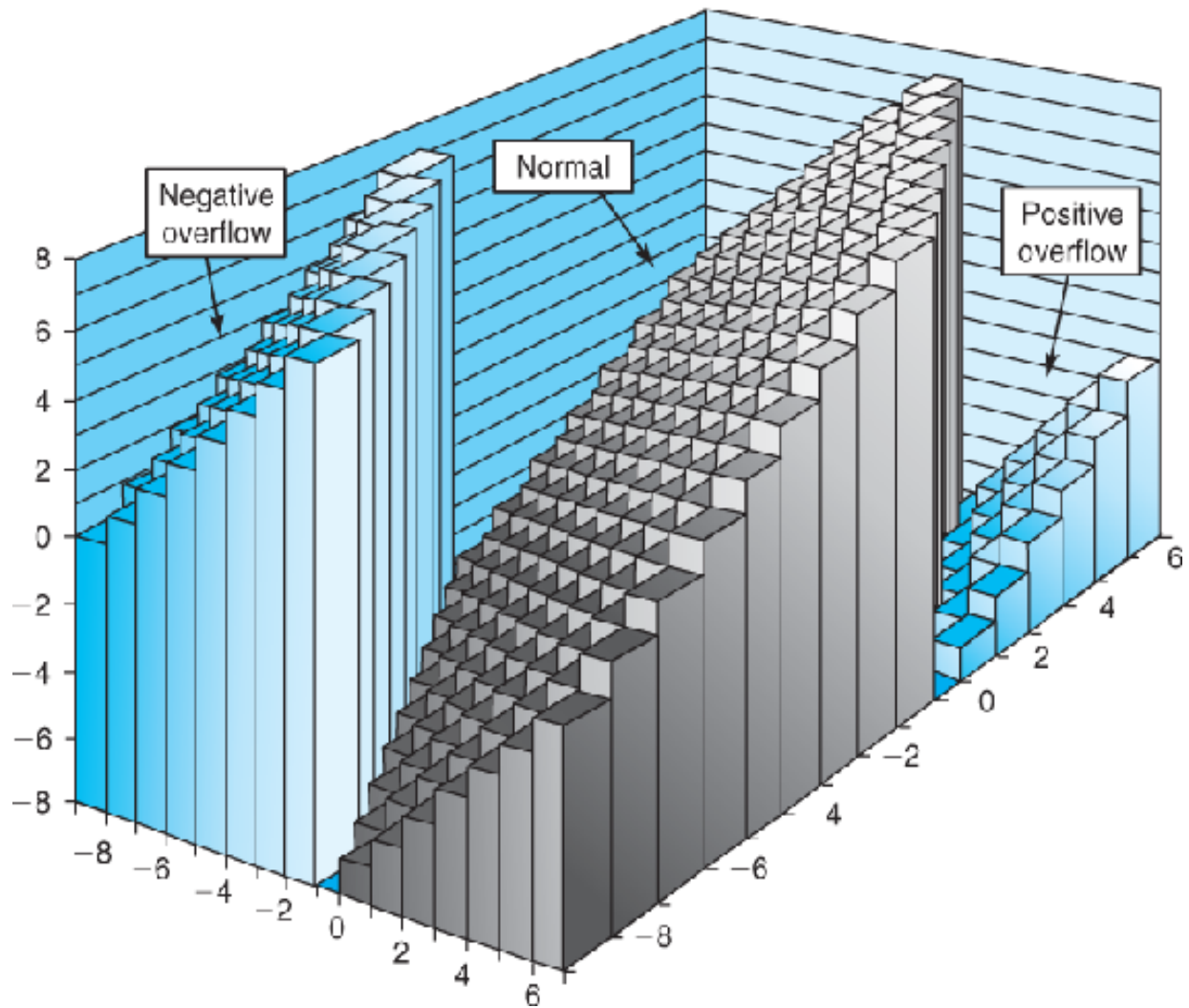
Detecting overflow in two's-complement addition

For  $x$  and  $y$  in the range  $TMin_w < x, y \leq TMax_w$ , let  $s \doteq x +_w^t y$ . Then the computation of  $s$  has had positive overflow if and only if  $x > 0$  and  $y > 0$  but  $s \leq 0$ . The computation has had negative overflow if and only if  $x < 0$  and  $y < 0$  but  $s \geq 0$ .

**Figure 2.25**  shows several illustrations of this principle for  $w = 4$ . The first entry shows a case of negative overflow, where two negative numbers sum to a positive one. The final entry shows a case of positive overflow, where two positive numbers sum to a negative one.



Two's-complement addition (4-bit word)



**Figure 2.26** Two's-complement addition.

With a 4-bit word size, addition can have a negative overflow when  $x + y < -8$  and a positive overflow when  $x + y \geq 8$ .

## Derivation:

Detecting overflow of two's-complement addition

Let us first do the analysis for positive overflow. If both  $x > 0$  and  $y > 0$  but  $s \leq 0$ , then clearly positive overflow has occurred. Conversely, positive overflow requires (1) that  $x > 0$  and  $y > 0$  (otherwise,  $x + y < TMax_w$ ), and (2)  $s \leq 0$  (from [Equation 2.13](#).) A similar set of arguments holds for negative overflow.

## *Practice Problem 2.29 (solution page [152](#))*

Fill in the following table in the style of [Figure 2.25](#). Give the integer values of the 5-bit arguments, the values of both their integer and two's-complement sums, the bit-level representation of the two's-complement sum, and the case from the derivation of [Equation 2.13](#).

## Practice Problem 2.30 (solution page [153](#))

Write a function with the following prototype:

```
/* Determine whether arguments can be added without overflow */
int tadd_ok(int x, int y);
```

This function should return 1 if arguments `x` and `y` can be added without causing overflow.

## Practice Problem 2.31 (solution page [153](#))

Your coworker gets impatient with your analysis of the overflow conditions for two's-complement addition and presents you with the following implementation of `tadd_ok`:

```
/* Determine whether arguments can be added without overflow */
/* WARNING: This code is buggy. */
int tadd_ok(int x, int y) {
    int sum = x+y;
    return (sum-x == y) && (sum-y == x);
}
```

You look at the code and laugh. Explain why.

## Practice Problem 2.32 (solution page [153](#))

You are assigned the task of writing code for a function `tsub_ok`, with arguments `x` and `y`, that will return 1 if computing `x-y` does not cause overflow. Having just written the code for [Problem 2.30](#), you write the following:

```
/* Determine whether arguments can be subtracted without overflow
*/

/* WARNING: This code is buggy. */
int tsub_ok(int x, int y) {
    return tadd_ok(x, -y);
}
```

For what values of `x` and `y` will this function give incorrect results? Writing a correct version of this function is left as an exercise ([Problem 2.74](#)).

## 2.3.3 Two's-Complement Negation

We can see that every number  $x$  in the range  $TMin_w \leq x \leq TMax_w$  has an additive inverse under  $-^t_w$ , which we denote  $-^t_w x$  as follows:

### Principle:

Two's-complement negation

For  $x$  in the range  $TMin_w \leq x \leq TMax_w$ , its two's-complement negation  $-^t_w x$  is given by the formula

$$-^t_w x = \begin{cases} TMin_w, & x = TMin_w \\ -x & x > TMin_w \end{cases} \quad (2.15)$$

That is, for  $w$ -bit, two's-complement addition,  $TMin_w$  is its own additive in-verse, while any other value  $x$  has  $-x$  as its additive inverse.

## Derivation:

Two's-complement negation


Observe that

$TMin_w + TMin_w = -2^w - 1 + -2^{w-1} = -2^w$ . This would cause negative overflow, and hence

$TMin_w + {}^t_w TMin_w = -2^w + 2^w = 0$ . For values of  $x$  such that  $x > TMin_w$ , the value  $-x$  can also be represented as a  $w$ -bit, two's-complement number, and their sum will be  $-x + x = 0$ .

## *Practice Problem 2.33 (solution page [153](#))*

We can represent a bit pattern of length  $w = 4$  with a single hex digit. For a two's-complement interpretation of these digits, fill in the following table to determine the additive inverses of the digits shown:

What do you observe about the bit patterns generated by two's-complement and unsigned ([Problem 2.28](#) ) negation?

# Web Aside DATA:TNEG it-level representation of two's-complement negation

There are several clever ways to determine the two's-complement negation of a value represented at the bit level. The following two techniques are both useful, such as when one encounters the value `0xfffffffffa` when debugging a program, and they lend insight into the nature of the two's-complement representation.

One technique for performing two's-complement negation at the bit level is to complement the bits and then increment the result. In C, we can state that for any integer value  $x$ , computing the expressions `-x` and `~x + 1` will give identical results.

Here are some examples with a 4-bit word size:

For our earlier example, we know that the complement of `0xf` is `0x0` and the complement of `0xa` is `0x5`, and so `0xfffffffffa` is the two's-complement representation of  $-6$ .

A second way to perform two's-complement negation of a number  $x$  is based on splitting the bit vector into two parts. Let  $k$  be the position of the rightmost 1, so the bit-level representation of  $x$  has the form  $[x_{w-1}, x_{w-2}, \dots, x_{k+1}, 1, 0, \dots, 0]$ . (This is possible as long as  $x \neq 0$ .) The negation is then written in binary form as  $[\sim x_{w-1}, \sim x_{w-2}, \dots, \sim x_{k+1}, 1, 0, \dots, 0]$ . That is, we complement each bit to the left of bit position  $k$ .

We illustrate this idea with some 4-bit numbers, where we highlight the rightmost pattern 1, 0, ..., 0 in italics:



## 2.3.4 Unsigned Multiplication

Integers  $x$  and  $y$  in the range  $0 \leq x, y \leq 2^w - 1$  can be represented as  $w$ -bit unsigned numbers, but their product  $x \cdot y$  can range between 0 and  $(2^w - 1)^2 = 2^{2w} - 2^{w+1} + 1$ . This could require as many as  $2w$  bits to represent. Instead, unsigned multiplication in C is defined to yield the  $w$ -bit value given by the low-order  $w$  bits of the  $2w$ -bit integer product. Let us denote this value as  $x *_w^u y$ .

Truncating an unsigned number to  $w$  bits is equivalent to computing its value modulo  $2^w$ , giving the following:

### Principle:

Unsigned multiplication

For  $x$  and  $y$  such that  $0 \leq x, y \leq UMax_w$ :

$$x *_w^u y = (x \cdot y) \bmod 2^w \quad (2.16)$$

## 2.3.5 Two's-Complement Multiplication

Integers  $x$  and  $y$  in the range  $-2^{w-1} \leq x, y \leq 2^{w-1} - 1$  can be represented as  $w$ -bit two's-complement numbers, but their product  $x \cdot y$  can range between  $-2^{w-1} \cdot (2^{w-1} - 1) = -2^{2w-2} + 2^{w-1}$  and  $-2^{w-1} \cdot -2^{w-1} = 2^{2w-2}$ . This could require as many as  $2w$  bits to represent in two's-complement form. Instead, signed multiplication in C generally is performed by truncating the  $2w$ -bit product to  $w$  bits. We denote this value as  $x *_w^t y$ . Truncating a two's-complement number to  $w$  bits is equivalent to first computing its value modulo  $2^w$  and then converting from unsigned to two's complement, giving the following:

### Principle:

Two's-complement multiplication

For  $x$  and  $y$  such that  $TMin_w \leq x, y \leq TMax_w$ :

$$x *_w^t y = U2T_w ((x \cdot y) \bmod 2^w) \quad (2.17)$$

We claim that the bit-level representation of the product operation is identical for both unsigned and two's-complement multiplication, as stated by the following principle:

## Principle:

Bit-level equivalence of unsigned and two's-complement multiplication

Let  $\vec{x}$  and  $\vec{y}$  be bit vectors of length  $w$ . Define integers  $x$  and  $y$  as the values represented by these bits in two's-complement form:

$x = B2T_w(\vec{x})$  and  $y = B2T_w(\vec{y})$ . Define nonnegative integers  $x'$

and  $y'$  as the values represented by these bits in unsigned form:

$x' = B2U_w(\vec{x})$  and  $y' = B2U_w(\vec{y})$ . Then

$$T2B_w(x *_w^t y) = U2B_w(x' *_w^u y')$$

As illustrations, [Figure 2.27](#) shows the results of multiplying different 3-bit numbers. For each pair of bit-level operands, we perform both unsigned and two's-complement multiplication, yielding 6-bit products, and then truncate these to 3 bits. The unsigned truncated product always equals  $x \cdot y \bmod 8$ . The bit-level representations of both truncated products are identical for both unsigned and two's-complement multiplication, even though the full 6-bit representations differ.

**Figure 2.27 Three-bit unsigned and two's-complement multiplication examples.** Although the bit-level representations of the full products may differ, those of the truncated products are identical.

## Derivation:

Bit-level equivalence of unsigned and two's-complement multiplication

From [Equation 2.6](#), we have  $x' = x + x_{w-1}2^w$  and  $y' = y + y_{w-1}2^w$ . Computing the product of these values modulo  $2^w$  gives the following:

$$\begin{aligned} (x' \cdot y') \bmod 2^w &= [(x + x_{w-1}2^w) \cdot (y + y_{w-1}2^w)] \bmod 2^w \quad (2.18) \\ &= [x \cdot y + (x_{w-1}y + y_{w-1}x)2^w + x_{w-1}2^{2w}] \bmod 2^w \\ &= (x \cdot y) \bmod 2^w \end{aligned}$$

The terms with weight  $2^w$  and  $2^{2w}$  drop out due to the modulus operator.

By [Equation 2.17](#), we have  $x *_w^t y = U2T_w((x \cdot y) \bmod 2^w)$ .

We can apply the operation  $T2U_w$  to both sides to get

$$T2U_w(x *_w^t y) = T2U_w(U2T_w((x \cdot y) \bmod 2^w)) = (x \cdot y) \bmod 2^w$$

Combining this result with [Equations 2.16](#) and [2.18](#) shows that

$T2U_w(x *_w^t y) = (x' \cdot y') \bmod 2^w = x' *_w^u y'$ . We can then apply  $U2B_w$  to both sides to get

$$U2B_w(T2U_w(x *_w^t y)) = T2B_w(x *_w^t y) = U2B_w(x' *_w^u y')$$

## Practice Problem 2.34 (solution page 153)

Fill in the following table showing the results of multiplying different 3-bit numbers, in the style of [Figure 2.27](#):

## Practice Problem 2.35 (solution page 154)

You are given the assignment to develop code for a function `tmult_ok` that will determine whether two arguments can be multiplied without causing overflow. Here is your solution:


```
/* Determine whether arguments can be multiplied without overflow */
int tmult_ok(int x, int y) {
    int p = x*y;
    /* Either x is zero, or dividing p by x gives y */
    return !x || p/x == y;
}
```

You test this code for a number of values of `x` and `y`, and it seems to work properly. Your coworker challenges you, saying, “If I can’t use subtraction to test whether addition has overflowed (see [Problem 2.31](#)), then how can you use division to test whether multiplication has overflowed?”

Devise a mathematical justification of your approach, along the following lines. First, argue that the case  $x = 0$  is handled correctly. Otherwise, consider  $w$ -bit numbers  $x$  ( $x \neq 0$ ),  $y$ ,  $p$ , and  $q$ , where  $p$  is the result of performing two’s-complement multiplication on  $x$  and  $y$ , and  $q$  is the result of dividing  $p$  by  $x$ .

1. Show that  $x \cdot y$ , the integer product of  $x$  and  $y$ , can be written in the form  $x \cdot y = p + t2^w$ , where  $t \neq 0$  if and only if the computation of  $p$  overflows.
2. Show that  $p$  can be written in the form  $p = x \cdot q + r$ , where  $|r| < |x|$ .
3. Show that  $q = y$  if and only if  $r = t = 0$ .

## *Practice Problem 2.36 (solution page **154**)*

For the case where data type `int` has 32 bits, devise a version of `tmult_ok` (**Problem 2.35** ) that uses the 64-bit precision of data type `int64_t`, without using division.

## *Practice Problem 2.37 (solution page [155](#))*

You are given the task of patching the vulnerability in the XDR code shown in the aside on page 100 for the case where both data types `int` and `size_t` are 32 bits. You decide to eliminate the possibility of the multiplication overflowing by computing the number of bytes to allocate using data type `uint64_t`. You replace the original call to `malloc` (line 9) as follows:

# Aside Security vulnerability in the XDR library

In 2002, it was discovered that code supplied by Sun Microsystems to implement the XDR library, a widely used facility for sharing data structures between programs, had a security vulnerability arising from the fact that multiplication can overflow without any notice being given to the program. Code similar to that containing the vulnerability is shown below:



```

1 /* Illustration of code vulnerability similar to that found in
2 * Sun's XDR library.
3 */
4 void* copy_elements(void *ele_src[], int ele_cnt, size_t
ele_size) {
5     /*
6     * Allocate buffer for ele_cnt objects, each of ele_size
bytes
7     * and copy from locations designated by ele_src
8     */
9     void *result = malloc(ele_cnt * ele_size);
10    if (result == NULL)
11        /* malloc failed */
12        return NULL;
13    void *next = result;
14    int i;
15    for (i = 0; i < ele_cnt; i++) {
16        /* Copy object i to destination */
17        memcpy(next, ele_src[i], ele_size);
18        /* Move pointer to next memory region */
19        next += ele_size;
20    }
21    return result;
22 }

```

The function `copy_elements` is designed to copy `ele_cnt` data structures, each consisting of `ele_size` bytes into a buffer allocated by the function on line 9. The number of bytes required is computed as `ele_cnt * ele_size`.

Imagine, however, that a malicious programmer calls this function with `ele_cnt` being 1,048,577 ( $2^{20} + 1$ ) and `ele_size` being 4,096 ( $2^{12}$ ) with the program compiled for 32 bits. Then the multiplication on line 9 will

overflow, causing only 4096 bytes to be allocated, rather than the 4,294,971,392 bytes required to hold that much data. The loop starting at line 15 will attempt to copy all of those bytes, overrunning the end of the allocated buffer, and therefore corrupting other data structures. This could cause the program to crash or otherwise misbehave. The Sun code was used by almost every operating system, and in such widely used programs as Internet Explorer and the Kerberos authentication system. The Computer Emergency Response Team (CERT), an organization run by the Carnegie Mellon Software Engineering Institute to track security vulnerabilities and breaches, issued advisory “CA-2002-25,” and many companies rushed to patch their code. Fortunately, there were no reported security breaches caused by this vulnerability.

A similar vulnerability existed in many implementations of the library function `calloc`. These have since been patched. Unfortunately, many programmers call allocation functions, such as `malloc`, using arithmetic expressions as arguments, without checking these expressions for overflow. Writing a reliable version of `calloc` is left as an exercise (**Problem 2.76** [□](#).)

```
uint64_t asize =
    ele_cnt * (uint64_t) ele_size;
void *result = malloc(asize);
```

Recall that the argument to `malloc` has type `size_t`.

- A. Does your code provide any improvement over the original?
- B. How would you change the code to eliminate the vulnerability?

## 2.3.6 Multiplying by Constants

Historically, the integer multiply instruction on many machines was fairly slow, requiring 10 or more clock cycles, whereas other integer operations—such as addition, subtraction, bit-level operations, and shifting—required only 1 clock cycle. Even on the Intel Core i7 Haswell we use as our reference machine, integer multiply requires 3 clock cycles. As a consequence, one important optimization used by compilers is to attempt to replace multiplications by constant factors with combinations of shift and addition operations. We will first consider the case of multiplying by a power of 2, and then we will generalize this to arbitrary constants.

### Principle:

Multiplication by a power of 2

Let  $x$  be the unsigned integer represented by bit pattern  $[x_{w-1}, x_{w-2}, \dots, x_0]$ . Then for any  $k \geq 0$ , the  $w + k$ -bit unsigned representation of  $x2^k$  is given by  $[x_{w-1}, x_{w-2}, \dots, x_0, 0, \dots, 0]$ , where  $k$  zeros have been added to the right.

So, for example, 11 can be represented for  $w = 4$  as [1011]. Shifting this left by  $k = 2$  yields the 6-bit vector [101100], which encodes the unsigned number  $11 \cdot 4 = 44$ .

## Derivation:

Multiplication by a power of 2

This property can be derived using [Equation 2.1](#):

$$\begin{aligned} B2U_{w+k}([x_{w-1}, x_{w-2}, \dots, x_0, 0, \dots, 0]) &= \sum_{i=0}^{w-1} x_i 2^{i+k} \\ &= \left[ \sum_{i=0}^{w-1} x_i 2^i \right] \cdot 2^k \\ &= x 2^k \end{aligned}$$

When shifting left by  $k$  for a fixed word size, the high-order  $k$  bits are discarded, yielding

$$[x_{w-k-1}, x_{w-k-2}, \dots, x_0, 0, \dots, 0]$$

but this is also the case when performing multiplication on fixed-size words. We can therefore see that shifting a value left is equivalent to performing unsigned multiplication by a power of 2:

## Principle:

Unsigned multiplication by a power of 2

For C variables `x` and `k` with unsigned values  $x$  and  $k$ , such that  $0 \leq k < w$ , the C expression `x << k` yields the value  $x \overset{*u}{w} 2^k$ .

Since the bit-level operation of fixed-size two's-complement arithmetic is equivalent to that for unsigned arithmetic, we can make a similar statement about the relationship between left shifts and multiplication by a power of 2 for two's-complement arithmetic:

## Principle:

Two's-complement multiplication by a power of 2

For C variables `x` and `k` with two's-complement value  $x$  and unsigned value  $k$ , such that  $0 \leq k < w$ , the C expression `x << k` yields the value  $x \overset{*t}{w} 2^k$ .

Note that multiplying by a power of 2 can cause overflow with either unsigned or two's-complement arithmetic. Our result shows that even then we will get the same effect by shifting. Returning to our earlier example, we shifted the 4-bit pattern [1011] (numeric value 11) left by two positions to get [101100] (numeric value 44). Truncating this to 4 bits gives [1100] (numeric value 12 = 44 mod 16).

Given that integer multiplication is more costly than shifting and adding, many C compilers try to remove many cases where an integer is being multiplied by a constant with combinations of shifting, adding, and subtracting. For example, suppose a program contains the expression  $x * 14$ . Recognizing that  $14 = 2^3 + 2^2 + 2^1$ , the compiler can rewrite the multiplication as  $(x \ll 3) + (x \ll 2) + (x \ll 1)$ , replacing one multiplication with three shifts and two additions. The two computations will yield the same result, regardless of whether  $x$  is unsigned or two's complement, and even if the multiplication would cause an overflow. Even better, the compiler can also use the property  $14 = 2^4 - 2^1$  to rewrite the multiplication as  $(x \ll 4) - (x \ll 1)$ , requiring only two shifts and a subtraction.

## Practice Problem 2.38 (solution page 155)

As we will see in [Chapter 3](#), the `LEA` instruction can perform computations of the form  $(a \ll k) + b$ , where  $k$  is either 0, 1, 2, or 3, and  $b$  is either 0 or some program value. The compiler often uses this instruction to perform multiplications by constant factors. For example, we can compute  $3 * a$  as  $(a \ll 1) + a$ .

Considering cases where  $b$  is either 0 or equal to  $a$ , and all possible values of  $k$ , what multiples of  $a$  can be computed with a single `LEA` instruction?

Generalizing from our example, consider the task of generating code for the expression  $x * K$ , for some constant  $K$ . The compiler can express the binary representation of  $K$  as an alternating sequence of zeros and ones:

$$[(0 \dots 0) (1 \dots 1) (0 \dots 0) \cdots (1 \dots 1)]$$

For example, 14 can be written as  $[(0 \dots 0)(111)(0)]$ . Consider a run of ones from bit position  $n$  down to bit position  $m$  ( $n \geq m$ ). (For the case of 14, we have  $n = 3$  and  $m = 1$ .) We can compute the effect of these bits on the product using either of two different forms:

Form A:  $(x \ll n) + (x \ll (n - 1)) + \dots + (x \ll m)$

Form B:  $(x \ll (n + 1)) - (x \ll m)$

By adding together the results for each run, we are able to compute  $x * K$  without any multiplications. Of course, the trade-off between using combinations of shifting, adding, and subtracting versus a single multiplication instruction depends on the relative speeds of these instructions, and these can be highly machine dependent. Most compilers only perform this optimization when a small number of shifts, adds, and subtractions suffice.

### *Practice Problem 2.39 (solution page [156](#))*

How could we modify the expression for form B for the case where bit position  $n$  is the most significant bit?

### *Practice Problem 2.40 (solution page [156](#))*

For each of the following values of  $K$ , find ways to express  $x * K$  using only the specified number of operations, where we consider both additions and subtractions to have comparable cost. You may need to use some tricks beyond the simple form A and B rules we have considered so far.

### *Practice Problem 2.41 (solution page [156](#))*

For a run of ones starting at bit position  $n$  down to bit position  $m$  ( $n \geq m$ ), we saw that we can generate two forms of code, A and B. How should the compiler decide which form to use?

## 2.3.7 Dividing by Powers of 2

Integer division on most machines is even slower than integer multiplication—requiring 30 or more clock cycles. Dividing by a power of 2 can also be performed

### Figure 2.28 Dividing unsigned numbers by powers of 2.

The examples illustrate how performing a logical right shift by  $k$  has the same effect as dividing by  $2^k$  and then rounding toward zero.

using shift operations, but we use a right shift rather than a left shift. The two different right shifts—logical and arithmetic—serve this purpose for unsigned and two's-complement numbers, respectively.

Integer division always rounds toward zero. To define this precisely, let us introduce some notation. For any real number  $a$ , define  $\lfloor a \rfloor$  to be the unique integer  $a'$  such that  $a' \leq a < a' + 1$ . As examples,  $\lfloor 3.14 \rfloor = 3$ ,  $\lfloor -3.14 \rfloor = -4$ , and  $\lfloor 3 \rfloor = 3$ . Similarly, define  $\lceil a \rceil$  to be the unique integer  $a'$  such that  $a' - 1 < a \leq a'$ . As examples,  $\lceil 3.14 \rceil = 4$ ,  $\lceil -3.14 \rceil = -3$ , and  $\lceil 3 \rceil = 3$ . For  $x \geq 0$  and  $y > 0$ , integer division should yield  $\lfloor x/y \rfloor$ , while for  $x < 0$  and  $y > 0$ , it should yield  $\lceil x/y \rceil$ . That is, it should round down a positive result but round up a negative one.


The case for using shifts with unsigned arithmetic is straightforward, in part because right shifting is guaranteed to be performed logically for unsigned values.



## Principle:

Unsigned division by a power of 2

For C variables `x` and `k` with unsigned values  $x$  and  $k$ , such that  $0 \leq k < w$ , the C expression `x >> k` yields the value  $\lfloor x/2^k \rfloor$ .

As examples, [Figure 2.28](#)  shows the effects of performing logical right shifts on a 16-bit representation of 12,340 to perform division by 1, 2, 16, and 256. The zeros shifted in from the left are shown in italics. We also show the result we would obtain if we did these divisions with real arithmetic. These examples show that the result of shifting consistently rounds toward zero, as is the convention for integer division.

## Derivation:

Unsigned division by a power of 2

Let  $x$  be the unsigned integer represented by bit pattern  $[x_{w-1}, x_{w-2}, \dots, x_0]$ , and let  $k$  be in the range  $0 \leq k < w$ . Let  $x'$  be the unsigned number with  $w - k$ -bit representation  $[x_{w-1}, x_{w-2}, \dots, x_k]$ , and let  $x''$  be the unsigned number with  $k$ -bit representation  $[x_{k-1}, \dots, x_0]$ . We can therefore see that  $x = 2^k x' + x''$ , and that  $0 \leq x'' < 2^k$ . It therefore follows that  $\lfloor x/2^k \rfloor = x'$ .

Performing a logical right shift of bit vector  $[x_{w-1}, x_{w-2}, \dots, x_0]$  by  $k$  yields the bit vector

$$[0, \dots, 0, x_{w-1}, x_{w-2}, \dots, x_k]$$

### Figure 2.29 Applying arithmetic right shift.

The examples illustrate that arithmetic right shift is similar to division by a power of 2, except that it rounds down rather than toward zero.

This bit vector has numeric value  $x'$ , which we have seen is the value that would result by computing the expression `x >> k`.

The case for dividing by a power of 2 with two's-complement arithmetic is slightly more complex. First, the shifting should be performed using an *arithmetic* right shift, to ensure that negative values remain negative. Let us investigate what value such a right shift would produce.

## Principle:

Two's-complement division by a power of 2, rounding down

Let C variables `x` and `k` have two's-complement value  $x$  and unsigned value  $k$ , respectively, such that  $0 \leq k < w$ . The C expression `x >> k`, when the shift is performed arithmetically, yields the value  $\lfloor x/2^k \rfloor$ .

For  $x \geq 0$ , variable `x` has 0 as the most significant bit, and so the effect of an arithmetic shift is the same as for a logical right shift. Thus, an arithmetic right shift by  $k$  is the same as division by  $2^k$  for a nonnegative number. As an example of a negative number, [Figure 2.29](#) shows the effect of applying arithmetic right shift to a 16-bit representation of  $-12,340$  for different shift amounts. For the case when no rounding is required ( $k = 1$ ), the result will be  $x/2^k$ . When rounding is required, shifting causes the result to be rounded downward. For example, the shifting right by four has the effect of rounding  $-771.25$  down to  $-772$ . We will need to adjust our strategy to handle division for negative values of  $x$ .

## Derivation:

Two's-complement division by a power of 2, rounding down

Let  $x$  be the two's-complement integer represented by bit pattern  $[x_{w-1}, x_{w-2}, \dots, x_0]$ , and let  $k$  be in the range  $0 \leq k < w$ . Let  $x'$  be the two's-complement number represented by the  $w - k$  bits  $[x_{w-1}, x_{w-2}, \dots, x_k]$ , and let  $x''$  be the *unsigned* number represented by the low-order  $k$  bits  $[x_{k-1}, \dots, x_0]$ . By a similar analysis as the unsigned case, we have  $x = 2^k x' + x''$  and  $0 \leq x'' < 2^k$ , giving  $x' = \lfloor x/2^k \rfloor$ . Furthermore, observe that shifting bit vector  $[x_{w-1}, x_{w-2}, \dots, x_0]$  right *arithmetically* by  $k$  yields the bit vector

$$[x_{w-1}, \dots, x_{w-1}, x_{w-1}, x_{w-2}, \dots, x_k]$$

which is the sign extension from  $w - k$  bits to  $w$  bits of  $[x_{w-1}, x_{w-2}, \dots, x_k]$ . Thus, this shifted bit vector is the two's-complement representation of  $\lfloor x/2^k \rfloor$ .

### Figure 2.30 Dividing two's-complement numbers by powers of 2.


By adding a bias before the right shift, the result is rounded toward zero.

We can correct for the improper rounding that occurs when a negative number is shifted right by “biasing” the value before shifting.

## Principle:

Two's-complement division by a power of 2, rounding up

Let C variables `x` and `k` have two's-complement value  $x$  and unsigned value  $k$ , respectively, such that  $0 \leq k < w$ . The C expression `(x + (1 << k) - 1) >> k`, when the shift is performed arithmetically, yields the value  $\lceil x/2^k \rceil$ .

**Figure 2.30**  demonstrates how adding the appropriate bias before performing the arithmetic right shift causes the result to be correctly rounded. In the third column, we show the result of adding the bias value to  $-12,340$ , with the lower  $k$  bits (those that will be shifted off to the right) shown in italics. We can see that the bits to the left of these may or may not be incremented. For the case where no rounding is required ( $k = 1$ ), adding the bias only affects bits that are shifted off. For the cases where rounding is required, adding the bias causes the upper bits to be incremented, so that the result will be rounded toward zero.

The biasing technique exploits the property that  $\lceil x/y \rceil = \lfloor (x + y - 1)/y \rfloor$  for integers  $x$  and  $y$  such that  $y > 0$ . As examples, when  $x = -30$  and  $y = 4$ , we have  $x + y - 1 = -27$  and  $\lceil -30/4 \rceil = -7 = \lfloor -27/4 \rfloor$ . When  $x = -32$  and  $y = 4$ , we have  $x + y - 1 = -29$  and  $\lceil -32/4 \rceil = -8 = \lfloor -29/4 \rfloor$ .

## Derivation:

Two's-complement division by a power of 2, rounding up

To see that  $\lceil x/y \rceil = \lfloor (x + y - 1)/y \rfloor$ , suppose that  $x = qy + r$ , where  $0 \leq r < y$ , giving  $(x + y - 1)/y = q + (r + y - 1)/y$ , and so  $\lfloor (x + y - 1)/y \rfloor = q + \lfloor (r + y - 1)/y \rfloor$ . The latter term will equal 0 when  $r = 0$  and 1 when  $r > 0$ . That is, by adding a bias of  $y - 1$  to  $x$  and then rounding the division downward, we will get  $q$  when  $y$  divides  $x$  and  $q + 1$  otherwise.

Returning to the case where  $y = 2^k$ , the C expression `x + (1 << k) - 1` yields the value  $x + 2^k - 1$ . Shifting this right arithmetically by  $k$  therefore yields  $\lceil x/2^k \rceil$ .

These analyses show that for a two's-complement machine using arithmetic right shifts, the C expression

```
(x < 0 ? x + (1 << k) - 1 : x) >> k
```

will compute the value  $\lceil x/2^k \rceil$ .

## Practice Problem 2.42 (solution page [156](#))

Write a function `div16` that returns the value `x/16` for integer argument `x`.

Your function should not use division, modulus, multiplication, any conditionals (`if` or `?:`), any comparison operators (e.g., `<`, `>`, or `==`), or any loops. You may assume that data type `int` is 32 bits long and uses a two's-complement representation, and that right shifts are performed arithmetically.

We now see that division by a power of 2 can be implemented using logical or arithmetic right shifts. This is precisely the reason the two types of right shifts are available on most machines. Unfortunately, this approach does not generalize to division by arbitrary constants. Unlike multiplication, we cannot express division by arbitrary constants  $K$  in terms of division by powers of 2.

## Practice Problem 2.43 (solution page 157)

In the following code, we have omitted the definitions of constants `M` and `N`:

```
|
#define M          /* Mystery number 1 */
#define N          /* Mystery number 2 */
int arith(int x, int y) {
    int result = 0;
    result = x*M + y/N; /* M and N are mystery numbers. */
    return result;
}
```

We compiled this code for particular values of `M` and `N`. The compiler optimized the multiplication and division using the methods we have discussed. The following is a translation of the generated machine code back into C:

```
|
/* Translation of assembly code for arith */
int optarith(int x, int y) {
    int t = x;
    x <<= 5;
    x -= t;
    if (y < 0) y += 7;
    y >>= 3; /* Arithmetic shift */
    return x+y;
}
```

What are the values of `M` and `N`?



## 2.3.8 Final Thoughts on Integer Arithmetic

As we have seen, the “integer” arithmetic performed by computers is really a form of modular arithmetic. The finite word size used to represent numbers limits the range of possible values, and the resulting operations can overflow. We have also seen that the two's-complement representation provides a clever way to represent both negative and positive values, while using the same bit-level implementations as are used to perform unsigned arithmetic—operations such as addition, subtraction, multiplication, and even division have either identical or very similar bit-level behaviors, whether the operands are in unsigned or two's-complement form.

We have seen that some of the conventions in the C language can yield some surprising results, and these can be sources of bugs that are hard to recognize or understand. We have especially seen that the unsigned data type, while conceptually straightforward, can lead to behaviors that even experienced programmers do not expect. We have also seen that this data type can arise in unexpected ways—for example, when writing integer constants and when invoking library routines.

## Practice Problem 2.44 (solution page 157)

Assume data type `int` is 32 bits long and uses a two's-complement representation for signed values. Right shifts are performed arithmetically for signed values and logically for unsigned values. The variables are declared and initialized as follows:

```
int x = foo(); /* Arbitrary value */
int y = bar(); /* Arbitrary value */

unsigned ux = x;
unsigned uy = y;
```

For each of the following C expressions, either (1) argue that it is true (evaluates to 1) for all values of `x` and `y`, or (2) give values of `x` and `y` for which it is false (evaluates to 0):

- A. `(x > 0) || (x-1 < 0)`
- B. `(x & 7) != 7 || (x << 29 < 0)`
- C. `(x * x) >= 0`
- D. `x < 0 || -x <= 0`
- E. `x > 0 || -x >= 0`
- F. `x+y == uy+ux`
- G. `x*~y + uy*ux == -x`

## 2.4 Floating Point

A floating-point representation encodes rational numbers of the form  $V = x \times 2^y$ . It is useful for performing computations involving very large numbers ( $|V| \gg 0$ ),

### Aside The IEEE

The Institute of Electrical and Electronics Engineers (IEEE—pronounced “eye-triple-ee”) is a professional society that encompasses all of electronic and computer technology. It publishes journals, sponsors conferences, and sets up committees to define standards on topics ranging from power transmission to software engineering. Another example of an IEEE standard is the 802.11 standard for wireless networking.

numbers very close to 0 ( $|V| \ll 1$ ), and more generally as an approximation to real arithmetic.

Up until the 1980s, every computer manufacturer devised its own conventions for how floating-point numbers were represented and the details of the operations performed on them. In addition, they often did not worry too much about the accuracy of the operations, viewing speed and ease of implementation as being more critical than numerical precision.

All of this changed around 1985 with the advent of IEEE Standard 754, a carefully crafted standard for representing floating-point numbers and the operations performed on them. This effort started in 1976 under Intel's sponsorship with the design of the 8087, a chip that provided floating-point support for the 8086 processor. Intel hired William Kahan, a professor at the University of California, Berkeley, as a consultant to help design a floating-point standard for its future processors. They allowed Kahan to join forces with a committee generating an industry-wide standard under the auspices of the Institute of Electrical and Electronics Engineers (IEEE). The committee ultimately adopted a standard close to the one Kahan had devised for Intel. Nowadays, virtually all computers support

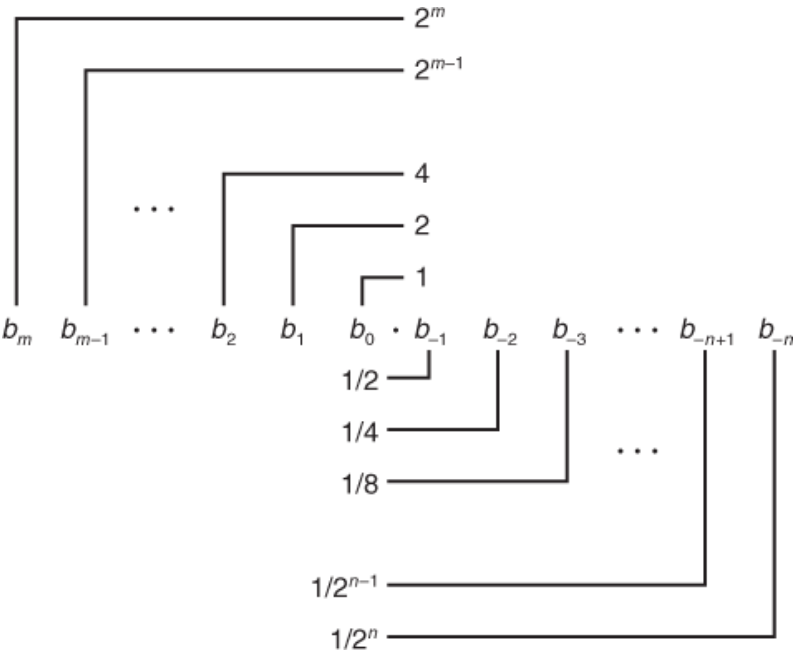
what has become known as *IEEE floating point*. This has greatly improved the portability of scientific application programs across different machines.

In this section, we will see how numbers are represented in the IEEE floating-point format. We will also explore issues of *rounding*, when a number cannot be represented exactly in the format and hence must be adjusted upward or downward. We will then explore the mathematical properties of addition, multiplication, and relational operators. Many programmers consider floating point to be at best uninteresting and at worst arcane and incomprehensible. We will see that since the IEEE format is based on a small and consistent set of principles, it is really quite elegant and understandable.

# 2.4.1 Fractional Binary Numbers

A first step in understanding floating-point numbers is to consider binary numbers having fractional values. Let us first examine the more familiar decimal notation. Decimal notation uses a representation of the form

$$d_m d_{m-1} \dots d_1 d_0 . d_{-1} d_{-2} \dots d_{-n}$$



**Figure 2.31 Fractional binary representation.**

Digits to the left of the binary point have weights of the form  $2^i$ , while those to the right have weights of the form  $1/2^i$ .

where each decimal digit  $d_i$  ranges between 0 and 9. This notation represents a value  $d$  defined as

$$d = \sum_{i=-n}^m 10^i \times d_i$$

The weighting of the digits is defined relative to the decimal point symbol ('.'), meaning that digits to the left are weighted by nonnegative powers of 10, giving integral values, while digits to the right are weighted by negative powers of 10, giving fractional values. For example,  $12.34_{10}$  represents the number  $1 \times 10^1 + 2 \times 10^0 + 3 \times 10^{-1} + 4 \times 10^{-2} = 12 \frac{34}{100}$ .

By analogy, consider a notation of the form

$$b_m b_{m-1} \dots b_1 b_0 . b_{-1} b_{-2} \dots b_{-n+1} b_{-n}$$

where each binary digit, or bit,  $b_i$  ranges between 0 and 1, as is illustrated in [Figure 2.31](#). This notation represents a number  $b$  defined as

$$b = \sum_{i=-n}^m 2^i \times b_i \tag{2.19}$$

The symbol '.' now becomes a *binary point*, with bits on the left being weighted by nonnegative powers of 2, and those on the right being weighted by negative powers of 2. For example,  $101.11_2$  represents the number

$$1 \times 2^2 + 0 \times 2^1 + 1 \times 2^0 + 1 \times 2^{-1} + 1 \times 2^{-2} = 4 + 0 + 1 + \frac{1}{2} + \frac{1}{4} = 5 \frac{3}{4}$$

One can readily see from [Equation 2.19](#) that shifting the binary point one position to the left has the effect of dividing the number by 2. For example, while  $101.11_2$  represents the number  $5 \frac{3}{4}$ ,  $10.111_2$  represents the number  $2 + 0 + \frac{1}{2} + \frac{1}{4} + \frac{1}{8} = 2 \frac{7}{8}$ . Similarly, shifting the binary point one position to the right has the effect of multiplying the number by 2. For example,  $1011.1_2$  represents the number  $8 + 0 + 2 + 1 + \frac{1}{2} = 11 \frac{1}{2}$ .

Note that numbers of the form  $0.11 \dots 1_2$  represent numbers just below 1. For example,  $0.111111_2$  represents  $\frac{63}{64}$ . We will use the shorthand notation  $1.0 - \epsilon$  to represent such values.

Assuming we consider only finite-length encodings, decimal notation cannot represent numbers such as  $\frac{1}{3}$  and  $\frac{5}{7}$  exactly. Similarly, fractional binary notation can only represent numbers that can be written  $x \times 2^y$ . Other values can only be approximated. For example, the number  $\frac{1}{5}$  can be represented exactly as the fractional decimal number 0.20. As a fractional binary number, however, we cannot represent it exactly and instead must approximate it with increasing accuracy by lengthening the binary representation:

### *Practice Problem 2.45 (solution page [157](#))*

Fill in the missing information in the following table:

## Practice Problem 2.46 (solution page 158)

The imprecision of floating-point arithmetic can have disastrous effects. On February 25, 1991, during the first Gulf War, an American Patriot Missile battery in Dharan, Saudi Arabia, failed to intercept an incoming Iraqi Scud missile. The Scud struck an American Army barracks and killed 28 soldiers. The US General Accounting Office (GAO) conducted a detailed analysis of the failure [76] and determined that the underlying cause was an imprecision in a numeric calculation. In this exercise, you will reproduce part of the GAO's analysis.

The Patriot system contains an internal clock, implemented as a counter that is incremented every 0.1 seconds. To determine the time in seconds, the program would multiply the value of this counter by a 24-bit quantity that was a fractional binary approximation to  $\frac{1}{10}$ . In particular, the binary representation of  $\frac{1}{10}$  is the nonterminating sequence  $0.000110011[0011]\dots_2$ , where the portion in brackets is repeated indefinitely. The program approximated 0.1, as a value  $x$ , by considering just the first 23 bits of the sequence to the right of the binary point:  $x = 0.00011001100110011001100$ . (See [Problem 2.51](#) for a discussion of how they could have approximated 0.1 more precisely.)

- A. What is the binary representation of  $0.1 - x$ ?
- B. What is the approximate decimal value of  $0.1 - x$ ?
- C. The clock starts at 0 when the system is first powered up and keeps counting up from there. In this case, the system had been running for around 100 hours. What was the difference between the actual time and the time computed by the software?
- D. The system predicts where an incoming missile will appear based on its velocity and the time of the last radar detection. Given that a Scud travels at around 2,000 meters per second, how far off was its prediction?

Normally, a slight error in the absolute time reported by a clock reading would not affect a tracking computation. Instead, it should depend on the relative time between two successive readings. The problem was that the



Patriot software had been upgraded to use a more accurate function for reading time, but not all of the function calls had been replaced by the new code. As a result, the tracking software used the accurate time for one reading and the inaccurate time for the other [103].

## 2.4.2 IEEE Floating-Point Representation

Positional notation such as considered in the previous section would not be efficient for representing very large numbers. For example, the representation of  $5 \times 2^{100}$  would consist of the bit pattern 101 followed by 100 zeros. Instead, we would like to represent numbers in a form  $x \times 2^y$  by giving the values of  $x$  and  $y$ .

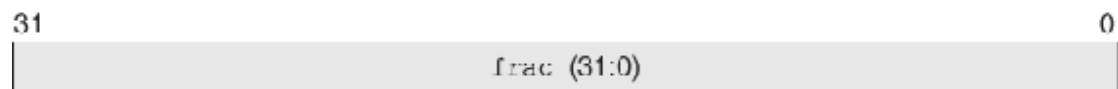
The IEEE floating-point standard represents a number in a form  $V = (-1)^s \times M \times 2^E$ :

- The *sign*  $s$  determines whether the number is negative ( $s = 1$ ) or positive ( $s = 0$ ), where the interpretation of the sign bit for numeric value 0 is handled as a special case.
- The *significand*  $M$  is a fractional binary number that ranges either between 1 and  $2 - \epsilon$  or between 0 and  $1 - \epsilon$ .
- The *exponent*  $E$  weights the value by a (possibly negative) power of 2.

Single precision



Double precision





**Figure 2.32 Standard floating-point formats.**

Floating-point numbers are represented by three fields. For the two most common formats, these are packed in 32-bit (single-precision) or 64-bit (double-precision) words.

The bit representation of a floating-point number is divided into three fields to encode these values:

- The single sign bit `s` directly encodes the sign  $s$ .
- The  $k$ -bit exponent field `exp` =  $e_{k-1} \cdots e_1 e_0$  encodes the exponent  $E$ .
- The  $n$ -bit fraction field `frac` =  $f_{n-1} \cdots f_1 f_0$  encodes the significand  $M$ , but the value encoded also depends on whether or not the exponent field equals 0.

**Figure 2.32**  shows the packing of these three fields into words for the two most common formats. In the single-precision floating-point format (a `float` in C), fields `s`, `exp`, and `frac` are 1,  $k = 8$ , and  $n = 23$  bits each, yielding a 32-bit representation. In the double-precision floating-point format (a `double` in C), fields `s`, `exp`, and `frac` are 1,  $k = 11$ , and  $n = 52$  bits each, yielding a 64-bit representation.

The value encoded by a given bit representation can be divided into three different cases (the latter having two variants), depending on the value of `exp`. These are illustrated in **Figure 2.33**  for the single-precision format.

## Case 1: Normalized Values

This is the most common case. It occurs when the bit pattern of `exp` is neither all zeros (numeric value 0) nor all ones (numeric value 255 for single precision, 2047 for double). In this case, the exponent field is interpreted as representing a signed integer in *biased* form. That is, the exponent value is  $E = e - Bias$ , where  $e$  is the unsigned number having bit representation  $e_{k-1} \cdots e_1 e_0$  and  $Bias$  is a bias value equal to  $2^{k-1} - 1$  (127 for single precision and 1023 for double). This yields exponent ranges from  $-126$  to  $+127$  for single precision and  $-1022$  to  $+1023$  for double precision.

The fraction field `frac` is interpreted as representing the fractional value  $f$ , where  $0 \leq f < 1$ , having binary representation  $0.f_{n-1} \cdots f_1 f_0$ , that is, with the

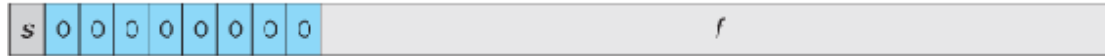
### Aside Why set the bias this way for denormalized values?

Having the exponent value be  $1 - Bias$  rather than simply  $-Bias$  might seem counterintuitive. We will see shortly that it provides for smooth transition from denormalized to normalized values.

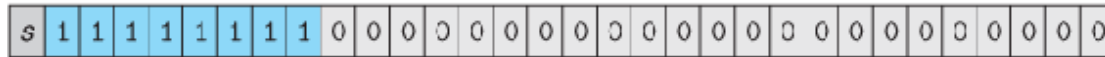
1. Normalized



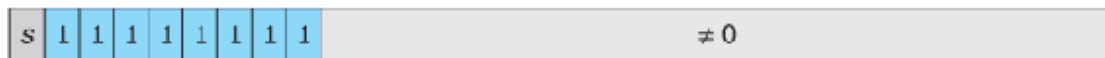
2. Denormalized



3a. Infinity



3b. NaN



**Figure 2.33 Categories of single-precision floating-point values.**

The value of the exponent determines whether the number is (1) normalized, (2) denormalized, or (3) a special value.

binary point to the left of the most significant bit. The significand is defined to be  $M = 1 + f$ . This is sometimes called an *implied leading 1* representation, because we can view  $M$  to be the number with binary representation  $1.f_{n-1}f_{n-2}\cdots f_0$ . This representation is a trick for getting an additional bit of precision for free, since we can always adjust the exponent  $E$  so that significand  $M$  is in the range  $1 \leq M < 2$  (assuming there is no overflow). We therefore do not need to explicitly represent the leading bit, since it always equals 1.

## Case 2: Denormalized Values

When the exponent field is all zeros, the represented number is in *denormalized* form. In this case, the exponent value is  $E = 1 - Bias$ , and the significand value is  $M = f$ , that is, the value of the fraction field without an implied leading 1.

Denormalized numbers serve two purposes. First, they provide a way to represent numeric value 0, since with a normalized number we must always have  $M \geq 1$ , and hence we cannot represent 0. In fact, the floating-point representation of +0.0 has a bit pattern of all zeros: the sign bit is 0, the exponent field is all zeros (indicating a denormalized value), and the fraction field is all zeros, giving  $M = f = 0$ . Curiously, when the sign bit is 1, but the other fields are all zeros, we get the value -0.0. With IEEE floating-point format, the values -0.0 and +0.0 are considered different in some ways and the same in others.

A second function of denormalized numbers is to represent numbers that are very close to 0.0. They provide a property known as *gradual underflow* in which possible numeric values are spaced evenly near 0.0.

## Case 3: Special Values

A final category of values occurs when the exponent field is all ones. When the fraction field is all zeros, the resulting values represent infinity, either  $+\infty$  when  $s = 0$  or  $-\infty$  when  $s = 1$ . Infinity can represent results that *overflow*, as when we multiply two very large numbers, or when we divide by zero. When the fraction field is nonzero, the resulting value is called a “NaN,” short for “not a number.” Such values are returned as the result of an operation where the result cannot be given as a real number or as infinity, as when computing  $\sqrt{-1}$  or  $\infty - \infty$ . They can also be useful in some applications for representing uninitialized data.

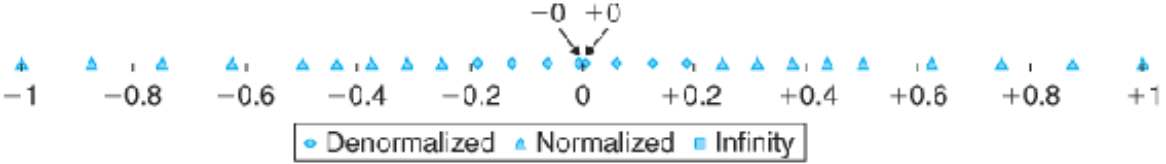
# 2.4.3 Example Numbers

Figure 2.34 shows the set of values that can be represented in a hypothetical 6-bit format having  $k = 3$  exponent bits and  $n = 2$  fraction bits. The bias is  $2^{3-1} - 1 = 3$ . Part (a) of the figure shows all representable values (other than NaN). The two infinities are at the extreme ends. The normalized numbers with maximum magnitude are  $\pm 14$ . The denormalized numbers are clustered around 0. These can be seen more clearly in part (b) of the figure, where we show just the numbers between  $-1.0$  and  $+1.0$ . The two zeros are special cases of denormalized numbers. Observe that the representable numbers are not uniformly distributed—they are denser nearer the origin.

Figure 2.35 shows some examples for a hypothetical 8-bit floating-point format having  $k = 4$  exponent bits and  $n = 3$  fraction bits. The bias is  $2^{4-1} - 1 = 7$ . The figure is divided into three regions representing the three classes of numbers. The different columns show how the exponent field encodes the exponent  $E$ , while the fraction field encodes the significand  $M$ , and together they form the



(a) Complete range



(b) Values between  $-1.0$  and  $+1.0$

**Figure 2.34 Representable values for 6-bit floating-point format.**  
 There are  $k = 3$  exponent bits and  $n = 2$  fraction bits. The bias is 3.

**Figure 2.35 Example nonnegative values for 8-bit floating-point format.**

There are  $k = 4$  exponent bits and  $n = 3$  fraction bits. The bias is 7.

represented value  $V = 2^E \times M$ . Closest to 0 are the denormalized numbers, starting with 0 itself. Denormalized numbers in this format have  $E = 1 - 7 = -6$ , giving a weight  $2^E = \frac{1}{64}$ . The fractions  $f$  and significands  $M$  range over the values  $0, \frac{1}{8}, \dots, \frac{7}{8}$ , giving numbers  $V$  in the range  $0$  to  $\frac{1}{64} \times \frac{7}{8} = \frac{7}{512}$ .

The smallest normalized numbers in this format also have  $E = 1 - 7 = -6$ , and the fractions also range over the values  $0, \frac{1}{8}, \dots, \frac{7}{8}$ . However, the significands then range from  $1 + 0 = 1$  to  $1 + \frac{7}{8} = \frac{15}{8}$ , giving numbers  $V$  in the range  $\frac{8}{512} = \frac{1}{64}$  to  $\frac{15}{512}$ .

Observe the smooth transition between the largest denormalized number  $\frac{7}{512}$  and the smallest normalized number  $\frac{8}{512}$ . This smoothness is due to our definition of  $E$  for denormalized values. By making it  $1 - Bias$  rather than  $-Bias$ , we compensate for the fact that the significand of a denormalized number does not have an implied leading 1.

As we increase the exponent, we get successively larger normalized values, passing through 1.0 and then to the largest normalized number. This number has exponent  $E = 7$ , giving a weight  $2^E = 128$ . The fraction equals  $\frac{7}{8}$  giving a significand  $M = \frac{15}{8}$ . Thus, the numeric value is  $V = 240$ . Going beyond this overflows to  $+\infty$ .

One interesting property of this representation is that if we interpret the bit representations of the values in [Figure 2.35](#) as unsigned integers, they occur in ascending order, as do the values they represent as floating-point numbers. This is no accident—the IEEE format was designed so that floating-point numbers could be sorted using an integer sorting routine. A minor difficulty occurs when dealing with negative numbers, since they have a leading 1 and occur in descending order, but this can be overcome without requiring floating-point operations to perform comparisons (see [Problem 2.84](#)).



## Practice Problem 2.47 (solution page 158)

Consider a 5-bit floating-point representation based on the IEEE floating-point format, with one sign bit, two exponent bits ( $k = 2$ ), and two fraction bits ( $n = 2$ ). The exponent bias is  $2^{2-1} - 1 = 1$ .

The table that follows enumerates the entire nonnegative range for this 5-bit floating-point representation. Fill in the blank table entries using the following directions:

$e$ : The value represented by considering the exponent field to be an unsigned integer

$E$ : The value of the exponent after biasing

$2^E$ : The numeric weight of the exponent

$f$ : The value of the fraction

$M$ : The value of the significand

$2^E \times M$ : The (unreduced) fractional value of the number

$V$ : The reduced fractional value of the number

Decimal: The decimal representation of the number

Express the values of  $2^E$ ,  $f$ ,  $M$ ,  $2^E \times M$ , and  $V$  either as integers (when possible) or as fractions of the form  $\frac{x}{y}$ , where  $y$  is a power of 2. You need not fill in entries marked —.

**Figure 2.36** shows the representations and numeric values of some important single- and double-precision floating-point numbers. As with the 8-bit format shown in **Figure 2.35**, we can see some general properties for a floating-point representation with a  $k$ -bit exponent and an  $n$ -bit fraction:

- The value +0.0 always has a bit representation of all zeros.
- The smallest positive denormalized value has a bit representation consisting of a 1 in the least significant bit position and otherwise all zeros. It has a fraction (and significand) value  $M = f = 2^{-n}$  and an exponent value  $E = -2^{k-1} + 2$ . The numeric value is therefore  $V = 2^{-n-2^{k-1}+2}$ .
- The largest denormalized value has a bit representation consisting of an exponent field of all zeros and a fraction field of all ones. It has a fraction (and significand) value  $M = f = 1 - 2^{-n}$  (which we have written  $1 - \epsilon$ ) and an exponent value  $E = -2^{k-1} + 2$ . The numeric value is therefore  $V = (1 - 2^{-n}) \times 2^{-2^{k-1}+2}$ , which is just slightly smaller than the smallest normalized value.

**Figure 2.36 Examples of nonnegative floating-point numbers.**

- The smallest positive normalized value has a bit representation with a 1 in the least significant bit of the exponent field and otherwise all zeros. It has a significand value  $M = 1$  and an exponent value  $E = -2^{k-1} + 2$ . The numeric value is therefore  $V = 2^{-2^{k-1}+2}$ .
- The value 1.0 has a bit representation with all but the most significant bit of the exponent field equal to 1 and all other bits equal to 0. Its significand value is  $M = 1$  and its exponent value is  $E = 0$ .
- The largest normalized value has a bit representation with a sign bit of 0, the least significant bit of the exponent equal to 0, and all other bits equal to 1. It has a fraction value of  $f = 1 - 2^{-n}$ , giving a significand  $M = 2 - 2^{-n}$  (which we have written  $2 - \epsilon$ .) It has an exponent value  $E = 2^{k-1} - 1$ , giving a numeric value  $V = (2 - 2^{-n}) \times 2^{2^{k-1}-1} = (1 - 2^{-n-1}) \times 2^{2^{k-1}}$ .

One useful exercise for understanding floating-point representations is to convert sample integer values into floating-point form. For example, we saw in **Figure**

2.15 □ that 12,345 has binary representation [11000000111001]. We create a normalized representation of this by shifting 13 positions to the right of a binary point, giving  $12345 = 1.1000000111001_2 \times 2^{13}$ . To encode this in IEEE single-precision format, we construct the fraction field by dropping the leading 1 and adding 10 zeros to the end, giving binary representation [10000001110010000000000]. To construct the exponent field, we add bias 127 to 13, giving 140, which has binary representation [10001100]. We combine this with a sign bit of 0 to get the floating-point representation in binary of [01000110010000001110010000000000]. Recall from Section 2.1.3 □ that we observed the following correlation in the bit-level representations of the integer value 12345 (0x3039) and the single-precision floating-point value 12345.0 (0x4640E400):

```

0 0 0 0 3 0 3 9
0000000000000000000011000000111001
          *****
          4 6 4 0 E 4 0 0
01000110010000001110010000000000

```

We can now see that the region of correlation corresponds to the low-order bits of the integer, stopping just before the most significant bit equal to 1 (this bit forms the implied leading 1), matching the high-order bits in the fraction part of the floating-point representation.

### Practice Problem 2.48 (solution page 159)


As mentioned in Problem 2.6 □, the integer 3,510,593 has hexadecimal representation 0x00359141, while the single-precision floating-point number 3,510,593.0 has hexadecimal representation 0x4A564504. Derive this floating-point representation and explain the correlation between the bits of the integer and floating-point representations.

*Practice Problem 2.49 (solution page **159**)*

- A. For a floating-point format with an  $n$ -bit fraction, give a formula for the smallest positive integer that cannot be represented exactly (because it would require an  $(n + 1)$ -bit fraction to be exact). Assume the exponent field size  $k$  is large enough that the range of representable exponents does not provide a limitation for this problem.
- B. What is the numeric value of this integer for single-precision format ( $n = 23$ )?

## 2.4.4 Rounding

Floating-point arithmetic can only approximate real arithmetic, since the representation has limited range and precision. Thus, for a value  $x$ , we generally want a systematic method of finding the “closest” matching value  $x'$  that can be represented in the desired floating-point format. This is the task of the *rounding* operation. One key problem is to define the direction to round a value that is halfway between two possibilities. For example, if I have \$1.50 and want to round it to the nearest dollar, should the result be \$1 or \$2? An alternative approach is to maintain a lower and an upper bound on the actual number. For example, we could determine representable values  $x^-$  and  $x^+$  such that the value  $x$  is guaranteed to lie between them:  $x^- \leq x \leq x^+$ . The IEEE floating-point format defines four different *rounding modes*. The default method finds a closest match, while the other three can be used for computing upper and lower bounds.

**Figure 2.37**  illustrates the four rounding modes applied to the problem of rounding a monetary amount to the nearest whole dollar. Round-to-even (also called round-to-nearest) is the default mode. It attempts to find a closest match. Thus, it rounds \$1.40 to \$1 and \$1.60 to \$2, since these are the closest whole dollar values. The only design decision is to determine the effect of rounding values that are halfway between two possible results. Round-to-even mode adopts the convention that it rounds the number either upward or downward such that the least significant digit of the result is even. Thus, it rounds both \$1.50 and \$2.50 to \$2.

The other three modes produce guaranteed bounds on the actual value. These can be useful in some numerical applications. Round-toward-zero mode rounds positive numbers downward and negative numbers upward, giving a value  $\hat{x}$  such

**Figure 2.37 Illustration of rounding modes for dollar rounding.**

The first rounds to a nearest value, while the other three bound the result above or below.

that  $|\hat{x}| \leq |x|$ . Round-down mode rounds both positive and negative numbers downward, giving a value  $x^-$  such that  $x^- \leq x$ . Round-up mode rounds both positive and negative numbers upward, giving a value  $x^+$  such that  $x \leq x^+$ .

Round-to-even at first seems like it has a rather arbitrary goal—why is there any reason to prefer even numbers? Why not consistently round values halfway between two representable values upward? The problem with such a convention is that one can easily imagine scenarios in which rounding a set of data values would then introduce a statistical bias into the computation of an average of the values. The average of a set of numbers that we rounded by this means would be slightly higher than the average of the numbers themselves. Conversely, if we always rounded numbers halfway between downward, the average of a set of rounded numbers would be slightly lower than the average of the numbers themselves. Rounding toward even numbers avoids this statistical bias in most real-life situations. It will round upward about 50% of the time and round downward about 50% of the time.

Round-to-even rounding can be applied even when we are not rounding to a whole number. We simply consider whether the least significant digit is even or odd. For example, suppose we want to round decimal numbers to the nearest hundredth. We would round 1.2349999 to 1.23 and 1.2350001 to 1.24, regardless of rounding mode, since they are not halfway between 1.23 and 1.24. On the other hand, we would round both 1.2350000 and 1.2450000 to 1.24, since 4 is even.

Similarly, round-to-even rounding can be applied to binary fractional numbers. We consider least significant bit value 0 to be even and 1 to be odd. In general, the rounding mode is only significant when we have a bit pattern of the form  $XX \dots X.YY \dots Y100 \dots$ , where  $X$  and  $Y$  denote arbitrary bit values with the rightmost  $Y$  being the position to which we wish to round. Only bit patterns of this form denote values that are halfway between two possible results. As examples, consider the

problem of rounding values to the nearest quarter (i.e., 2 bits to the right of the binary point.) We would round  $10.00011_2(2\frac{3}{32})$  down to  $10.00_2(2)$ , and  $10.00110_2(2\frac{3}{16})$  up to  $10.01_2(2\frac{1}{4})$ , because these values are not halfway between two possible values. We would round  $10.11100_2(2\frac{7}{8})$  up to  $11.00_2(3)$  and  $10.10100_2(2\frac{5}{8})$  down to  $10.10_2(2\frac{1}{2})$ , since these values are halfway between two possible results, and we prefer to have the least significant bit equal to zero.

### *Practice Problem 2.50 (solution page 159)*

Show how the following binary fractional values would be rounded to the nearest half (1 bit to the right of the binary point), according to the round-to-even rule. In each case, show the numeric values, both before and after rounding.

- A.  $10.010_2$
- B.  $10.011_2$
- C.  $10.110_2$
- D.  $11.001_2$

### *Practice Problem 2.51 (solution page 159)*

We saw in [Problem 2.46](#) that the Patriot missile software approximated 0.1 as  $x = 0.00011001100110011001100_2$ . Suppose instead that they had used IEEE round-to-even mode to determine an approximation  $x'$  to 0.1 with 23 bits to the right of the binary point.

- A. What is the binary representation of  $x'$ ?
- B. What is the approximate decimal value of  $x' - 0.1$ ?
- C. How far off would the computed clock have been after 100 hours of operation?
- D. How far off would the program's prediction of the position of the Scud missile have been?

## *Practice Problem 2.52 (solution page **160**)*

Consider the following two 7-bit floating-point representations based on the IEEE floating-point format. Neither has a sign bit—they can only represent nonnegative numbers.

### 1. Format A

- There are  $k = 3$  exponent bits. The exponent bias is 3.
- There are  $n = 4$  fraction bits.

### 2. Format B

- There are  $k = 4$  exponent bits. The exponent bias is 7.
- There are  $n = 3$  fraction bits.

Below, you are given some bit patterns in format A, and your task is to convert them to the closest value in format B. If necessary, you should apply the round-to-even rounding rule. In addition, give the values of numbers given by the format A and format B bit patterns. Give these as whole numbers (e.g., 17) or as fractions (e.g.,  $17/64$ ).



## 2.4.5 Floating-Point Operations

The IEEE standard specifies a simple rule for determining the result of an arithmetic operation such as addition or multiplication. Viewing floating-point values  $x$  and  $y$  as real numbers, and some operation  $\odot$  defined over real numbers, the computation should yield  $Round(x \odot y)$ , the result of applying rounding to the exact result of the real operation. In practice, there are clever tricks floating-point unit designers use to avoid performing this exact computation, since the computation need only be sufficiently precise to guarantee a correctly rounded result. When one of the arguments is a special value, such as  $-0$ ,  $\infty$ , or  $NaN$ , the standard specifies conventions that attempt to be reasonable. For example,  $1/-0$  is defined to yield  $-\infty$ , while  $1/+0$  is defined to yield  $+\infty$ .

One strength of the IEEE standard's method of specifying the behavior of floating-point operations is that it is independent of any particular hardware or software realization. Thus, we can examine its abstract mathematical properties without considering how it is actually implemented.

We saw earlier that integer addition, both unsigned and two's complement, forms an abelian group. Addition over real numbers also forms an abelian group, but we must consider what effect rounding has on these properties. Let us define  $x +^f y$  to be  $Round(x + y)$ . This operation is defined for all values of  $x$  and  $y$ , although it may yield infinity even when both  $x$  and  $y$  are real numbers due to overflow. The operation is commutative, with  $x +^f y = y +^f x$  for all values of  $x$  and  $y$ . On the other hand, the operation is not associative. For example, with single-precision floating point the expression `(3.14+1e10)-1e10` evaluates to `0.0`—the value 3.14 is lost due to rounding. On the other hand, the expression `3.14+(1e10-1e10)` evaluates to 3.14. As with an abelian group, most values have inverses under floating-point addition, that is,  $x +^f -x = 0$ . The exceptions are infinities (since  $+\infty -\infty = NaN$ ), and  $NaN$ s, since  $NaN +^f x = NaN$  for any  $x$ .

The lack of associativity in floating-point addition is the most important group property that is lacking. It has important implications for scientific programmers and

compiler writers. For example, suppose a compiler is given the following code fragment:

```
|  
x = a + b + c;  
y = b + c + d;
```

The compiler might be tempted to save one floating-point addition by generating the following code:

```
|  
t = b + c;  
x = a + t;  
y = t + d;
```

However, this computation might yield a different value for `x` than would the original, since it uses a different association of the addition operations. In most applications, the difference would be so small as to be inconsequential. Unfortunately, compilers have no way of knowing what trade-offs the user is willing to make between efficiency and faithfulness to the exact behavior of the original program. As a result, they tend to be very conservative, avoiding any optimizations that could have even the slightest effect on functionality.

On the other hand, floating-point addition satisfies the following monotonicity property: if  $a \geq b$ , then  $x +^f a \geq x +^f b$  for any values of  $a$ ,  $b$ , and  $x$  other than  $NaN$ . This property of real (and integer) addition is not obeyed by unsigned or two's-complement addition.

Floating-point multiplication also obeys many of the properties one normally associates with multiplication. Let us define  $x *^f y$  to be  $Round(x \times y)$ . This operation is closed under multiplication (although possibly yielding infinity or  $NaN$ ), it is commutative, and it has 1.0 as a multiplicative identity. On the other hand, it is not

associative, due to the possibility of overflow or the loss of precision due to rounding. For example, with single-precision floating point, the expression `(1e20*1e20)*1e-20` evaluates to `+∞`, while `1e20*(1e20*1e-20)` evaluates to `1e20`. In addition, floating-point multiplication does not distribute over addition. For example, with single-precision floating point, the expression `1e20*(1e20-1e20)` evaluates to `0.0`, while `1e20*1e20-1e20*1e20` evaluates to `NaN`.

On the other hand, floating-point multiplication satisfies the following monotonicity properties for any values  $a$ ,  $b$ , and  $c$  other than  $NaN$ :

$$\begin{aligned} a \geq b \quad \text{and} \quad c \geq 0 &\Rightarrow a *^f c \geq b *^f c \\ a \geq b \quad \text{and} \quad c \leq 0 &\Rightarrow a *^f c \leq b *^f c \end{aligned}$$

In addition, we are also guaranteed that  $a *^f a \geq 0$ , as long as  $a \neq NaN$ . As we saw earlier, none of these monotonicity properties hold for unsigned or two's-complement multiplication.

This lack of associativity and distributivity is of serious concern to scientific programmers and to compiler writers. Even such a seemingly simple task as writing code to determine whether two lines intersect in three-dimensional space can be a major challenge.

## 2.4.6 Floating Point in C

All versions of C provide two different floating-point data types: `float` and `double`. On machines that support IEEE floating point, these data types correspond to single- and double-precision floating point. In addition, the machines use the round-to-even rounding mode. Unfortunately, since the C standards do not require the machine to use IEEE floating point, there are no standard methods to change the rounding mode or to get special values such as  $-0$ ,  $+\infty$ ,  $-\infty$ , or *NaN*. Most systems provide a combination of include `(.h)` files and procedure libraries to provide access to these features, but the details vary from one system to another. For example, the GNU compiler `gcc` defines program constants `INFINITY` (for  $+\infty$ ) and `NAN` (for *NaN*) when the following sequence occurs in the program file:

```
|  
#define _GNU_SOURCE 1  
#include <math.h>
```

### *Practice Problem 2.53 (solution page [160](#))*

Fill in the following macro definitions to generate the double-precision values  $+\infty$ ,  $-\infty$ , and  $-0$ :

```
|  
#define POS_INFINITY  
#define NEG_INFINITY  
#define NEG_ZERO
```

You cannot use any include files (such as `math.h`), but you can make use of the fact that the largest finite number that can be represented with double precision is around  $1.8 \times 10^{308}$ .

When casting values between `int`, `float`, and `double` formats, the program changes the numeric values and the bit representations as follows (assuming data type `int` is 32 bits):

- From `int` to `float`, the number cannot overflow, but it may be rounded.
- From `int` or `float` to `double`, the exact numeric value can be preserved because `double` has both greater range (i.e., the range of representable values), as well as greater precision (i.e., the number of significant bits).
- From `double` to `float`, the value can overflow to  $+\infty$  or  $-\infty$ , since the range is smaller. Otherwise, it may be rounded, because the precision is smaller.
- From `float` or `double` to `int`, the value will be rounded toward zero. For example, 1.999 will be converted to 1, while  $-1.999$  will be converted to  $-1$ . Furthermore, the value may overflow. The C standards do not specify a fixed result for this case. Intel-compatible microprocessors designate the bit pattern `[10 ... 00]` ( $TMin_w$  for word size  $w$ ) as an *integer indefinite* value. Any conversion from floating point to integer that cannot assign a reasonable integer approximation yields this value. Thus, the expression `(int) +1e10` yields `-21483648`, generating a negative value from a positive one.

## Practice Problem 2.54 (solution page **160**)

Assume variables `x`, `f`, and `d` are of type `int`, `float`, and `double`, respectively. Their values are arbitrary, except that neither `f` nor `d` equals  $+\infty$ ,  $-\infty$ , or `NaN`. For each of the following C expressions, either argue that it will always be true (i.e., evaluate to 1) or give a value for the variables such that it is not true (i.e., evaluates to 0).

- A. `x == (int)(double) x`
- B. `x == (int)(float) x`
- C. `d == (double)(float) d`
- D. `f == (float)(double) f`
- E. `f == -(-f)`
- F. `1.0/2 == 1/2.0`
- G. `d*d >= 0.0`
- H. `(f+d)-f == d`

## 2.5 Summary

Computers encode information as bits, generally organized as sequences of bytes. Different encodings are used for representing integers, real numbers, and character strings. Different models of computers use different conventions for encoding numbers and for ordering the bytes within multi-byte data.

The C language is designed to accommodate a wide range of different implementations in terms of word sizes and numeric encodings. Machines with 64-bit word sizes have become increasingly common, replacing the 32-bit machines that dominated the market for around 30 years. Because 64-bit machines can also run programs compiled for 32-bit machines, we have focused on the distinction between 32-and 64-bit programs, rather than machines. The advantage of 64-bit programs is that they can go beyond the 4 GB address limitation of 32-bit programs.

Most machines encode signed numbers using a two's-complement representation and encode floating-point numbers using IEEE Standard 754. Understanding these encodings at the bit level, as well as understanding the mathematical characteristics of the arithmetic operations, is important for writing programs that operate correctly over the full range of numeric values.

When casting between signed and unsigned integers of the same size, most C implementations follow the convention that the underlying bit pattern does not change. On a two's-complement machine, this behavior is characterized by functions  $T2U_w$  and  $U2T_w$ , for a  $w$ -bit value. The implicit casting of C gives results that many programmers do not anticipate, often leading to program bugs.

Due to the finite lengths of the encodings, computer arithmetic has properties quite different from conventional integer and real arithmetic. The finite length can cause numbers to overflow, when they exceed the range of the representation. Floating-point values can also underflow, when they are so close to 0.0 that they are changed to zero.

The finite integer arithmetic implemented by C, as well as most other programming languages, has some peculiar properties compared to true integer arithmetic. For example, the expression `x*x` can evaluate to a negative number due to overflow. Nonetheless, both unsigned and two's-complement arithmetic satisfy many of the other properties of integer arithmetic, including associativity, commutativity, and distributivity. This allows compilers to do many optimizations. For example, in replacing the expression `7*x` by `(x<<3)-x`, we make use of the associative, commutative, and distributive properties, along with the relationship between shifting and multiplying by powers of 2.

We have seen several clever ways to exploit combinations of bit-level operations and arithmetic operations. For example, we saw that



with two's-complement arithmetic,  $\sim x + 1$  is equivalent to  $-x$ . As another example, suppose we want a bit

## Aside Ariane 5: The high cost of floating-point overflow

Converting large floating-point numbers to integers is a common source of programming errors. Such an error had disastrous consequences for the maiden voyage of the Ariane 5 rocket, on June 4, 1996. Just 37 seconds after liftoff, the rocket veered off its flight path, broke up, and exploded. Communication satellites valued at \$500 million were on board the rocket.

A later investigation [73, 33] showed that the computer controlling the inertial navigation system had sent invalid data to the computer controlling the engine nozzles. Instead of sending flight control information, it had sent a diagnostic bit pattern indicating that an overflow had occurred during the conversion of a 64-bit floating-point number to a 16-bit signed integer.

The value that overflowed measured the horizontal velocity of the rocket, which could be more than five times higher than that achieved by the earlier Ariane 4 rocket. In the design of the Ariane 4 software, they had carefully analyzed the numeric values and determined that the horizontal velocity would never overflow a 16-bit number. Unfortunately, they simply reused this part of the software in the Ariane 5 without checking the assumptions on which it had been based.

pattern of the form  $[0, \dots, 0, 1, \dots, 1]$ , consisting of  $w - k$  zeros followed by  $k$  ones. Such bit patterns are useful for masking operations. This pattern can be generated by the C expression `(1<<k)-1`, exploiting the property that the desired bit pattern has numeric value  $2^k - 1$ . For example, the expression `(1<<8)-1` will generate the bit pattern `0xFF`.

Floating-point representations approximate real numbers by encoding numbers of the form  $x \times 2^y$ . IEEE Standard 754 provides for several different precisions, with the most common being single (32 bits) and double (64 bits). IEEE floating point also has representations for special values representing plus and minus infinity, as well as not-a-number.

Floating-point arithmetic must be used very carefully, because it has only limited range and precision, and because it does not obey common mathematical properties such as associativity.

# Bibliographic Notes

Reference books on C [45, 61] discuss properties of the different data types and operations. Of these two, only Steele and Harbison [45] cover the newer features found in ISO C99. There do not yet seem to be any books that cover the features found in ISO C11. The C standards do not specify details such as precise word sizes or numeric encodings. Such details are intentionally omitted to make it possible to implement C on a wide range of different machines. Several books have been written giving advice to C programmers [59, 74] that warn about problems with overflow, implicit casting to unsigned, and some of the other pitfalls we have covered in this chapter. These books also provide helpful advice on variable naming, coding styles, and code testing. Seacord's book on security issues in C and C++ programs [97] combines information about C programs, how they are compiled and executed, and how vulnerabilities may arise. Books on Java (we recommend the one coauthored by James Gosling, the creator of the language [5]) describe the data formats and arithmetic operations supported by Java.

Most books on logic design [58, 116] have a section on encodings and arithmetic operations. Such books describe different ways of implementing arithmetic circuits. Overton's book on IEEE floating point [82] provides a detailed description of the format as well as the

properties from the perspective of a numerical applications programmer.

[OceanofPDF.com](http://OceanofPDF.com)

# Homework Problems

## 2.55 ♦

Compile and run the sample code that uses `show_bytes` (file `show-bytes.c`) on different machines to which you have access. Determine the byte orderings used by these machines.

## 2.56 ♦

Try running the code for `show_bytes` for different sample values.

## 2.57 ♦

Write procedures `show_short`, `show_long`, and `show_double` that print the byte representations of C objects of types `short`, `long`, and `double`, respectively. Try these out on several machines.

## 2.58 ♦♦

Write a procedure `is_little_endian` that will return 1 when compiled and run on a little-endian machine, and will return 0 when compiled and run on a big-endian machine. This program should run on any machine, regardless of its word size.

## 2.59 ♦♦

Write a C expression that will yield a word consisting of the least significant byte of `x` and the remaining bytes of `y`. For operands `x = 0x89ABCDEF` and `y = 0x76543210`, this would give `0x765432EF`.

## 2.60 ♦♦

Suppose we number the bytes in a  $w$ -bit word from 0 (least significant) to  $w/8 - 1$  (most significant). Write code for the following C function, which will return an unsigned value in which byte `i` of argument `x` has been replaced by byte `b`:

```
|  
unsigned replace_byte (unsigned x, int i, unsigned char  
b);
```

Here are some examples showing how the function should work:

```
|  
replace_byte(0x12345678, 2, 0xAB) --> 0x12AB5678  
replace_byte(0x12345678, 0, 0xAB) --> 0x123456AB
```



# Bit-Level Integer Coding Rules

In several of the following problems, we will artificially restrict what programming constructs you can use to help you gain a better understanding of the bit-level, logic, and arithmetic operations of C. In answering these problems, your code must follow these rules:

- Assumptions
  - Integers are represented in two's-complement form.
  - Right shifts of signed data are performed arithmetically.
  - Data type `int` is  $w$  bits long. For some of the problems, you will be given a specific value for  $w$ , but otherwise your code should work as long as  $w$  is a multiple of 8. You can use the expression `sizeof(int)<<3` to compute  $w$ .
- Forbidden
  - Conditionals (`if` or `?:`), loops, switch statements, function calls, and macro invocations.
  - Division, modulus, and multiplication.
  - Relative comparison operators (`<`, `>`, `<=`, and `>=`).
- Allowed operations
  - All bit-level and logic operations.
  - Left and right shifts, but only with shift amounts between 0 and  $w - 1$ .
  - Addition and subtraction.
  - Equality (`==`) and inequality (`!=`) tests. (Some of the problems do not allow these.)

- Integer constants `INT_MIN` and `INT_MAX`.
- Casting between data types `int` and `unsigned`, either explicitly or implicitly.

Even with these rules, you should try to make your code readable by choosing descriptive variable names and using comments to describe the logic behind your solutions. As an example, the following code extracts the most significant byte from integer argument `x`:

```
/* Get most significant byte from x */
int get_msb(int x) {
    /* Shift by w-8 */
    int shift_val = (sizeof(int)-1)<<3;
    /* Arithmetic shift */
    int xright = x >> shift_val;
    /* Zero all but LSB */
    return xright & 0xFF;
}
```

## 2.61 ♦♦

Write C expressions that evaluate to 1 when the following conditions are true and to 0 when they are false. Assume `x` is of type `int`.

- A. Any bit of `x` equals 1.
- B. Any bit of `x` equals 0.
- C. Any bit in the least significant byte of `x` equals 1.
- D. Any bit in the most significant byte of `x` equals 0.

Your code should follow the bit-level integer coding rules (page 128), with the additional restriction that you may not use equality (`==`) or inequality (`!=`) tests.

## 2.62 ♦♦♦

Write a function `int_shifts_are_arithmetic()` that yields 1 when run on a machine that uses arithmetic right shifts for data type `int` and yields 0 otherwise. Your code should work on a machine with any word size. Test your code on several machines.

## 2.63 ◆◆◆

Fill in code for the following C functions. Function `sr1` performs a logical right shift using an arithmetic right shift (given by value `xsra`), followed by other operations not including right shifts or division. Function `sra` performs an arithmetic right shift using a logical right shift (given by value `xsr1`), followed by other operations not including right shifts or division. You may use the computation `8*sizeof(int)` to determine  $w$ , the number of bits in data type `int`. The shift amount `k` can range from `0` to  $w - 1$ .

```
|
unsigned srl(unsigned x, int k) {
    /* Perform shift arithmetically */
    unsigned xsra = (int) x >> k;
    .
    .
    .
    .
    .
    .
    .
}
int sra(int x, int k) {
    /* Perform shift logically */
    int xsrl = (unsigned) x >> k;
    .
    .
    .
    .
    .
    .
    .
}
```

## 2.64 ♦

Write code to implement the following function:

```
|  
/* Return 1 when any odd bit of x equals 1; 0 otherwise.  
   Assume w=32 */  
int any_odd_one(unsigned x);
```

Your function should follow the bit-level integer coding rules (page [128](#)), except that you may assume that data type `int` has  $w = 32$  bits.

## 2.65 ♦♦♦♦

Write code to implement the following function:

```
|  
/* Return 1 when x contains an odd number of 1s; 0  
otherwise.  
Assume w=32 */  
int odd_ones(unsigned x);
```

Your function should follow the bit-level integer coding rules (page [128](#)), except that you may assume that data type `int` has  $w = 32$  bits.

Your code should contain a total of at most 12 arithmetic, bitwise, and logical operations.

## 2.66 ◆◆◆◆

Write code to implement the following function:

```
|
/*
 * Generate mask indicating leftmost 1 in x. Assume w=32.
 * For example, 0xFF00 -> 0x8000, and 0x6600 -> 0x4000.
 * If x = 0, then return 0.
 */
int leftmost_one(unsigned x);
```

Your function should follow the bit-level integer coding rules (page 128), except that you may assume that data type `int` has  $w = 32$  bits.

Your code should contain a total of at most 15 arithmetic, bitwise, and logical operations.

*Hint:* First transform `x` into a bit vector of the form `[0 ... 011 ... 1]`.



## 2.67 ♦♦

You are given the task of writing a procedure `int_size_is_32()` that yields 1 when run on a machine for which an `int` is 32 bits, and yields 0 otherwise. You are not allowed to use the `sizeof` operator. Here is a first attempt:

```
|
1  /* The following code does not run properly on some
   machines */
2  int bad_int_size_is_32() {
3      /* Set most significant bit (msb) of 32-bit
   machine */
4      int set_msb = 1 << 31;
5      /* Shift past msb of 32-bit word */
6      int beyond_msb = 1 << 32;
7
8      /* set_msb is nonzero when word size >= 32
   beyond_msb is zero when word size <= 32 */
9      return set_msb && !beyond_msb;
10
11 }
```

When compiled and run on a 32-bit SUN SPARC, however, this procedure returns 0. The following compiler message gives us an indication of the problem:

```
warning: left shift count >= width of type
```

- A. In what way does our code fail to comply with the C standard?
- B. Modify the code to run properly on any machine for which data type `int` is at least 32 bits.
- C. Modify the code to run properly on any machine for which data type `int` is at least 16 bits.

## 2.68 ♦♦

Write code for a function with the following prototype:

```
/*  
 * Mask with least significant n bits set to 1  
 * Examples: n = 6 -> 0x3F, n = 17 -> 0x1FFFF  
 * Assume 1 <= n <= w  
 */  
int lower_one_mask(int n);
```

Your function should follow the bit-level integer coding rules (page [128](#)). Be careful of the case `n = w`.

## 2.69 ◆◆◆

Write code for a function with the following prototype:

```
|  
/*  
 * Do rotating left shift. Assume 0 <= n < w  
 * Examples when x = 0x12345678 and w = 32:  
 * n=4 -> 0x23456781, n=20 -> 0x67812345  
 */  
unsigned rotate_left(unsigned x, int n);
```

Your function should follow the bit-level integer coding rules (page [128](#)). Be careful of the case `n = 0`.

## 2.70 ♦♦

Write code for the function with the following prototype:

```
|  
/*  
 * Return 1 when x can be represented as an n-bit, 2's-  
 complement  
 * number; 0 otherwise  
 * Assume 1 <= n <= w  
 */  
int fits_bits(int x, int n);
```

Your function should follow the bit-level integer coding rules (page [128](#)).

## 2.71

You just started working for a company that is implementing a set of procedures to operate on a data structure where 4 signed bytes are packed into a 32-bit `unsigned`. Bytes within the word are numbered from 0 (least significant) to 3 (most significant). You have been assigned the task of implementing a function for a machine using two's-complement arithmetic and arithmetic right shifts with the following prototype:

```
/* Declaration of data type where 4 bytes are packed
   into an unsigned */
typedef unsigned packed_t;

/* Extract byte from word. Return as signed integer */
int xbyte(packed_t word, int bytenum);
```

That is, the function will extract the designated byte and sign extend it to be a 32-bit `int`.

Your predecessor (who was fired for incompetence) wrote the following code:

```
|  
/* Failed attempt at xbyte */  
int xbyte(packed_t word, int bytenum)  
{  
    return (word >> (bytenum << 3)) & 0xFF;  
}
```

- A. What is wrong with this code?
- B. Give a correct implementation of the function that uses only left and right shifts, along with one subtraction.

## 2.72

You are given the task of writing a function that will copy an integer `val` into a buffer `buf`, but it should do so only if enough space is available in the buffer.

Here is the code you write:

```
/* Copy integer into buffer if space is available */
/* WARNING: The following code is buggy */
void copy_int(int val, void *buf, int maxbytes) {
    if (maxbytes - sizeof(val) >= 0)
        memcpy(buf, (void *) &val, sizeof(val));
}
```

This code makes use of the library function `memcpy`. Although its use is a bit artificial here, where we simply want to copy an `int`, it illustrates an approach commonly used to copy larger data structures.

You carefully test the code and discover that it *always* copies the value to the buffer, even when `maxbytes` is too small.

- A. Explain why the conditional test in the code always succeeds. *Hint:* The `sizeof` operator returns a value of type `size_t`.
- B. Show how you can rewrite the conditional test to make it work properly.

## 2.73

Write code for a function with the following prototype:

```
|  
/* Addition that saturates to TMin or TMax */  
int saturating_add(int x, int y);
```

Instead of overflowing the way normal two's-complement addition does, saturating addition returns *TMax* when there would be positive overflow, and *TMin* when there would be negative overflow. Saturating arithmetic is commonly used in programs that perform digital signal processing.

Your function should follow the bit-level integer coding rules (page [128](#)).



## 2.74

Write a function with the following prototype:

```
|  
/* Determine whether arguments can be subtracted without  
overflow */  
int tsub_ok(int x, int y);
```

This function should return 1 if the computation `x-y` does not overflow.

## 2.75

Suppose we want to compute the complete  $2w$ -bit representation of  $x \cdot y$ , where both  $x$  and  $y$  are unsigned, on a machine for which data type `unsigned` is  $w$  bits. The low-order  $w$  bits of the product can be computed with the expression `x*y`, so we only require a procedure with prototype


```
|  
unsigned unsigned_high_prod(unsigned x, unsigned y);
```

that computes the high-order  $w$  bits of  $x \cdot y$  for unsigned variables.

We have access to a library function with prototype

```
|  
int signed_high_prod(int x, int y);
```

that computes the high-order  $w$  bits of  $x \cdot y$  for the case where  $x$  and  $y$  are in two's-complement form. Write code calling this procedure to implement the function for unsigned arguments. Justify the correctness of your solution.

*Hint:* Look at the relationship between the signed product  $x \cdot y$  and the unsigned product  $x' \cdot y'$  in the derivation of [Equation 2.18](#) .

## 2.76

The library function `calloc` has the following declaration:

```
void *calloc(size_t nmemb, size_t size);
```

According to the library documentation, “The `calloc` function allocates memory for an array of `nmemb` elements of `size` bytes each. The memory is set to zero. If `nmemb` or `size` is zero, then `calloc` returns `NULL`.”

Write an implementation of `calloc` that performs the allocation by a call to `malloc` and sets the memory to zero via `memset`.

Your code should not have any vulnerabilities due to arithmetic overflow, and it should work correctly regardless of the number of bits used to represent data of type `size_t`.

As a reference, functions `malloc` and `memset` have the following declarations:

```
void *malloc(size_t size);  
void *memset(void *s, int c, size_t n);
```

## 2.77

Suppose we are given the task of generating code to multiply integer variable `x` by various different constant factors  $K$ . To be efficient, we want to use only the operations  $+$ ,  $-$ , and  $\ll$ . For the following values of  $K$ , write C expressions to perform the multiplication using at most three operations per expression.

- A.  $K = 17$
- B.  $K = -7$
- C.  $K = 60$
- D.  $K = -112$

## 2.78

Write code for a function with the following prototype:

```
/* Divide by power of 2. Assume 0 <= k < w-1 */  
int divide_power2(int x, int k);
```

The function should compute  $x/2^k$  with correct rounding, and it should follow the bit-level integer coding rules (page [128](#)).

## 2.79

Write code for a function `mul3div4` that, for integer argument `x`, computes  $3*x/4$  but follows the bit-level integer coding rules (page 128). Your code should replicate the fact that the computation  $3*x$  can cause overflow.

## 2.80

Write code for a function `threefourths` that, for integer argument `x`, computes the value of  $\frac{3}{4}x$ , rounded toward zero. It should not overflow. Your function should follow the bit-level integer coding rules (page 128).

## 2.81

Write C expressions to generate the bit patterns that follow, where  $a^k$  represents  $k$  repetitions of symbol  $a$ . Assume a  $w$ -bit data type. Your code may contain references to parameters `j` and `k`, representing the values of  $j$  and  $k$ , but not a parameter representing  $w$ .

A.  $1^{w-k}0^k$

B.  $0^{w-k-j}1^k0^j$

## 2.82

We are running programs where values of type `int` are 32 bits. They are represented in two's complement, and they are right shifted arithmetically. Values of type `unsigned` are also 32 bits.

We generate arbitrary values `x` and `y`, and convert them to unsigned values as follows:

```
|
/* Create some arbitrary values */
int x = random();
int y = random();
/* Convert to unsigned */
unsigned ux = (unsigned) x;
unsigned uy = (unsigned) y;
```

For each of the following C expressions, you are to indicate whether or not the expression *always* yields 1. If it always yields 1, describe the underlying mathematical principles. Otherwise, give an example of arguments that make it yield 0.

- A. `(x < y) == (-x > -y)`
- B. `((x + y) << 4) + y - x == 17 * y + 15 * x`
- C. `~x + ~y + 1 == ~(x + y)`
- D. `(ux - uy) == -(unsigned)(y - x)`
- E. `((x >> 2) << 2) <= x`

## 2.83

Consider numbers having a binary representation consisting of an infinite string of the form  $0.y y y y y \dots$ , where  $y$  is a  $k$ -bit sequence. For example, the binary representation of  $\frac{1}{3}$  is  $0.01010101 \dots$  ( $y = 01$ ), while the representation of  $\frac{1}{5}$  is  $0.001100110011 \dots$  ( $y = 0011$ ).

- A. Let  $Y = B2U_k(y)$ , that is, the number having binary representation  $y$ . Give a formula in terms of  $Y$  and  $k$  for the value represented by the infinite string. *Hint:* Consider the effect of shifting the binary point  $k$  positions to the right.
- B. What is the numeric value of the string for the following values of  $y$ ?
- 101
  - 0110
  - 010011

## 2.84

Fill in the return value for the following procedure, which tests whether its first argument is less than or equal to its second. Assume the function `f2u` returns an unsigned 32-bit number having the same bit representation as its floating-point argument. You can assume that neither argument is *NaN*. The two flavors of zero, `+0` and `-0`, are considered equal.

```
|
int float_le(float x, float y) {
    unsigned ux = f2u(x);
    unsigned uy = f2u(y);
    /* Get the sign bits */
    unsigned sx = ux >> 31;
    unsigned sy = uy >> 31;

    /* Give an expression using only ux, uy, sx, and sy */
    return ;
}
```



## 2.85

Given a floating-point format with a  $k$ -bit exponent and an  $n$ -bit fraction, write formulas for the exponent  $E$ , the significand  $M$ , the fraction  $f$ , and the value  $V$  for the quantities that follow. In addition, describe the bit representation.

- A. The number 7.0
- B. The largest odd integer that can be represented exactly
- C. The reciprocal of the smallest positive normalized value

## 2.86

Intel-compatible processors also support an “extended-precision” floating-point format with an 80-bit word divided into a sign bit,  $k = 15$  exponent bits, a single *integer* bit, and  $n = 63$  fraction bits. The integer bit is an explicit copy of the implied bit in the IEEE floating-point representation. That is, it equals 1 for normalized values and 0 for denormalized values. Fill in the following table giving the approximate values of some “interesting” numbers in this format:

This format can be used in C programs compiled for Intel-compatible machines by declaring the data to be of type `long double`. However, it forces the compiler to generate code based on the legacy 8087 floating-point instructions. The resulting program will most likely run much slower than would be the case for data type `float` or `double`.

## 2.87

The 2008 version of the IEEE floating-point standard, named IEEE 754-2008, includes a 16-bit “half-precision” floating-point format. It was originally devised by computer graphics companies for storing data in which a higher dynamic range is required than can be achieved with 16-bit integers. This format has 1 sign bit, 5 exponent bits ( $k = 5$ ), and 10 fraction bits ( $n = 10$ ). The exponent bias is  $2^{5-1} - 1 = 15$ .

Fill in the table that follows for each of the numbers given, with the following instructions for each column:

**Hex:** The four hexadecimal digits describing the encoded form.

**$M$ :** The value of the significand. This should be a number of the form  $x$  or  $\frac{x}{y}$ , where  $x$  is an integer and  $y$  is an integral power of 2. Examples include 0,  $\frac{67}{64}$ , and  $\frac{1}{256}$ .

**$E$ :** The integer value of the exponent.

**$V$ :** The numeric value represented. Use the notation  $x$  or  $x \times 2^z$ , where  $x$  and  $z$  are integers.

**$D$ :** The (possibly approximate) numerical value, as is printed using the `%f` formatting specification of `printf`.

As an example, to represent the number  $\frac{7}{8}$ , we would have  $s = 0$ ,  $M = \frac{7}{4}$  and  $E = -1$ . Our number would therefore have an exponent field of  $01110_2$  (decimal value  $15 - 1 = 14$ ) and a

significand field of  $1100000000_2$ , giving a hex representation `3B00`. The numerical value is 0.875.

You need not fill in entries marked —.

## 2.88

Consider the following two 9-bit floating-point representations based on the IEEE floating-point format.

### 1. Format A

- There is 1 sign bit.
- There are  $k = 5$  exponent bits. The exponent bias is 15.
- There are  $n = 3$  fraction bits.

### 2. Format B

- There is 1 sign bit.
- There are  $k = 4$  exponent bits. The exponent bias is 7.
- There are  $n = 4$  fraction bits.

In the following table, you are given some bit patterns in format A, and your task is to convert them to the closest value in format B. If rounding is necessary you should *round toward*  $+\infty$ . In addition, give the values of numbers given by the format A and format B bit patterns. Give these as whole numbers (e.g., 17) or as fractions (e.g.,  $17/64$  or  $17/2^6$ ).

## 2.89

We are running programs on a machine where values of type `int` have a 32-bit two's-complement representation. Values of type `float` use the 32-bit IEEE format, and values of type `double` use the 64-bit IEEE format.

We generate arbitrary integer values `x`, `y`, and `z`, and convert them to values of type `double` as follows:

```
|  
/* Create some arbitrary values */  
int x = random();  
int y = random();  
int z = random();  
/* Convert to double */  
double dx = (double) x;  
double dy = (double) y;  
double dz = (double) z;
```

For each of the following C expressions, you are to indicate whether or not the expression *always* yields 1. If it always yields 1, describe the underlying mathematical principles. Otherwise, give an example of arguments that make it yield 0. Note that you cannot use an IA32 machine running `gcc` to test your answers, since it would use the 80-bit extended-precision representation for both `float` and `double`.

- A. `(float) x == (float) dx`
- B. `dx - dy == (double) (x-y)`
- C. `(dx + dy) + dz == dx + (dy + dz)`
- D. `(dx * dy) * dz == dx * (dy * dz)`
- E. `dx / dx == dz / dz`

## 2.90

You have been assigned the task of writing a C function to compute a floating-point representation of  $2^x$ . You decide that the best way to do this is to directly construct the IEEE single-precision representation of the result. When  $x$  is too small, your routine will return 0.0. When  $x$  is too large, it will return  $+\infty$ . Fill in the blank portions of the code that follows to compute the correct result. Assume the function `u2f` returns a floating-point value having an identical bit representation as its unsigned argument.

```


float fpwr2(int x)
{
    /* Result exponent and fraction */
    unsigned exp, frac;
    unsigned u;
    if (x < _____){
        /* Too small. Return 0.0 */
        exp = _____;
        frac = _____;
    } else if (x < _____){
        /* Denormalized result */
        exp = _____;
        frac = _____;
    } else if (x < _____){
        /* Normalized result. */
        exp = _____;
        frac = _____;
    } else {
        /* Too big. Return +oo */
        exp = _____;
        frac = _____;
    }
    /* Pack exp and frac into 32 bits */
    u = exp << 23 | frac;
    /* Return as float */
    return u2f(u);
}

```



## 2.91

Around 250 B.C., the Greek mathematician Archimedes proved that  $\frac{223}{71} < \pi < \frac{22}{7}$ . Had he had access to a computer and the standard library `<math.h>`, he would have been able to determine that the single-precision floating-point approximation of  $\pi$  has the hexadecimal representation `0x40490FDB`. Of course, all of these are just approximations, since  $\pi$  is not rational.

- A. What is the fractional binary number denoted by this floating-point value?
- B. What is the fractional binary representation of  $\frac{22}{7}$ ?  
*Hint:* See [Problem 2.83](#) .
- C. At what bit position (relative to the binary point) do these two approximations to  $\pi$  diverge?

# Bit-Level Floating-Point Coding Rules

In the following problems, you will write code to implement floating-point functions, operating directly on bit-level representations of floating-point numbers. Your code should exactly replicate the conventions for IEEE floating-point operations, including using round-to-even mode when rounding is required.

To this end, we define data type `float_bits` to be equivalent to `unsigned`:

```
/* Access bit-level representation floating-point number */  
typedef unsigned float_bits;
```

Rather than using data type `float` in your code, you will use `float_bits`. You may use both `int` and `unsigned` data types, including unsigned and integer constants and operations. You may not use any unions, structs, or arrays. Most significantly, you may not use any floating-point data types, operations, or constants. Instead, your code should perform the bit manipulations that implement the specified floating-point operations.

The following function illustrates the use of these coding rules. For argument  $f$ , it returns  $\pm 0$  if  $f$  is denormalized (preserving the sign of  $f$ ), and returns  $f$  otherwise.

```
|  
/* If f is denorm, return 0. Otherwise, return f */  
float_bits float_denorm_zero(float_bits f) {  
    /* Decompose bit representation into parts */  
    unsigned sign = f >> 31;  
    unsigned exp = f >> 23 & 0xFF;  
    unsigned frac = f & 0x7FFFFFFF;  
    if (exp == 0) {  
        /* Denormalized. Set fraction to 0 */  
        frac = 0;  
    }  
    /* Reassemble bits */  
    return (sign << 31) | (exp << 23) | frac;  
}
```

## 2.92 ♦♦

Following the bit-level floating-point coding rules, implement the function with the following prototype:

```
/* Compute -f. If f is NaN, then return f. */  
float_bits float_negate(float_bits f);
```

For floating-point number  $f$ , this function computes  $-f$ . If  $f$  is *NaN*, your function should simply return  $f$ .

Test your function by evaluating it for all  $2^{32}$  values of argument `f` and comparing the result to what would be obtained using your machine's floating-point operations.

2.93 Following the bit-level floating-point coding rules, implement the function with the following prototype:

```
/* Compute |f|. If f is NaN, then return f. */  
float_bits float_absval(float_bits f);
```

For floating-point number  $f$ , this function computes  $|f|$ . If  $f$  is *NaN*, your function should simply return  $f$ .

Test your function by evaluating it for all  $2^{32}$  values of argument `f` and comparing the result to what would be obtained using your machine's floating-point operations.

## 2.94

Following the bit-level floating-point coding rules, implement the function with the following prototype:

```
/* Compute 2*f. If f is NaN, then return f. */  
float_bits float_twice(float_bits f);
```

For floating-point number  $f$ , this function computes  $2.0 \cdot f$ . If  $f$  is *NaN*, your function should simply return  $f$ .

Test your function by evaluating it for all  $2^{32}$  values of argument `f` and comparing the result to what would be obtained using your machine's floating-point operations.

## 2.95

Following the bit-level floating-point coding rules, implement the function with the following prototype:

```
/* Compute 0.5*f. If f is NaN, then return f. */  
float_bits float_half(float_bits f);
```

For floating-point number  $f$ , this function computes  $0.5 \cdot f$ . If  $f$  is *NaN*, your function should simply return  $f$ .

Test your function by evaluating it for all  $2^{32}$  values of argument `f` and comparing the result to what would be obtained using your machine's floating-point operations.

## 2.96

Following the bit-level floating-point coding rules, implement the function with the following prototype:

```
|  
/*  
 * Compute (int) f.  
 * If conversion causes overflow or f is NaN, return  
0x80000000  
 */  
int float_f2i(float_bits f);
```

For floating-point number  $f$ , this function computes `(int) f`. Your function should round toward zero. If  $f$  cannot be represented as an integer (e.g., it is out of range, or it is *NaN*), then the function should return `0x80000000`.

Test your function by evaluating it for all  $2^{32}$  values of argument `f` and comparing the result to what would be obtained using your machine's floating-point operations.

## 2.97

Following the bit-level floating-point coding rules, implement the function with the following prototype:

```
/* Compute (float) i */  
float_bits float_i2f(int i);
```

For argument `i`, this function computes the bit-level representation of `(float) i`.

Test your function by evaluating it for all  $2^{32}$  values of argument `f` and comparing the result to what would be obtained using your machine's floating-point operations.



# Solutions to Practice Problems

## Solution to Problem 2.1 [↗](#)(page 37)

Understanding the relation between hexadecimal and binary formats will be important once we start looking at machine-level programs. The method for doing these conversions is in the text, but it takes a little practice to become familiar.

- A. `0x39A7F8` to binary:
- B. Binary `1100100101111011` to hexadecimal:
- C. `0xD5E4C` to binary:
- D. Binary `1001101110011110110101` to hexadecimal:

## Solution to Problem 2.2 [↗](#)(page 37)

This problem gives you a chance to think about powers of 2 and their hexadecimal representations.

## Solution to Problem 2.3 (page 38)

This problem gives you a chance to try out conversions between hexadecimal and decimal representations for some smaller numbers. For larger ones, it becomes much more convenient and reliable to use a calculator or conversion program.

# Solution to Problem 2.4 (page 39)

When you begin debugging machine-level programs, you will find many cases where some simple hexadecimal arithmetic would be useful. You can always convert numbers to decimal, perform the arithmetic, and convert them back, but being able to work directly in hexadecimal is more efficient and informative.

- A.  $0x503c + 0x8 = 0x5044$ . Adding 8 to hex c gives 4 with a carry of 1.
- B.  $0x503c - 0x40 = 0x4ffc$ . Subtracting 4 from 3 in the second digit position requires a borrow from the third. Since this digit is 0, we must also borrow from the fourth position.
- C.  $0x503c + 64 = 0x507c$ . Decimal 64 ( $2^6$ ) equals hexadecimal 0x40.
- D.  $0x50ea - 0x503c = 0xae$ . To subtract hex c (decimal 12) from hex a (decimal 10), we borrow 16 from the second digit, giving hex e (decimal 14). In the second digit, we now subtract 3 from hex d (decimal 13), giving hex a (decimal 10).

# Solution to Problem 2.5 (page 48)

This problem tests your understanding of the byte representation of data and the two different byte orderings.

Recall that `show_bytes` enumerates a series of bytes starting from the one with lowest address and working toward the one with highest address. On a little-endian machine, it will list the bytes from least significant to most. On a big-endian machine, it will list bytes from the most significant byte to the least.

## Solution to Problem 2.6 (page 49)

This problem is another chance to practice hexadecimal to binary conversion. It also gets you thinking about integer and floating-point representations. We will explore these representations in more detail later in this chapter.

- A. Using the notation of the example in the text, we write the two strings as follows:

```
  0  0  3  5  9  1  4  1
0000000001101011001000101000001
          *****
  4  A  5  6  4  5  0  4
01001010010101100100010100000100
```

- B. With the second word shifted two positions to the right relative to the first, we find a sequence with 21 matching bits.
- C. We find all bits of the integer embedded in the floating-point number, except for the most significant bit having value 1. Such is the case for the example in the text as well. In addition, the floating-point number has some nonzero high-order bits that do not match those of the integer.

## Solution to Problem 2.7 [↗](#)(page 49)

It prints `61 62 63 64 65 66`. Recall also that the library routine `strlen` does not count the terminating null character, and so `show_bytes` printed only through the character `'f'`.

## Solution to Problem 2.8 [↗](#)(page 51)

This problem is a drill to help you become more familiar with Boolean operations.

# Solution to Problem 2.9 (page 53)

This problem illustrates how Boolean algebra can be used to describe and reason about real-world systems. We can see that this color algebra is identical to the Boolean algebra over bit vectors of length 3.

- A. Colors are complemented by complementing the values of  $R$ ,  $G$ , and  $B$ . From this, we can see that white is the complement of black, yellow is the complement of blue, magenta is the complement of green, and cyan is the complement of red.
- B. We perform Boolean operations based on a bit-vector representation of the colors. From this we get the following:

```
Blue (001)   |   Green (010)   = Cyan (011)
Yellow (110) &   Cyan (011)   = Green (010)
Red (100)    ^   Magenta (101) = Blue (001)
```

## Solution to Problem 2.10 [□](#)(page 54)

This procedure relies on the fact that EXCLUSIVE-OR is commutative and associative, and that  $a \wedge a = 0$  for any  $a$ .

See [Problem 2.11 \[□\]\(#\)](#) for a case where this function will fail.



# Solution to Problem 2.11 [↗](#)(page 55)

This problem illustrates a subtle and interesting feature of our inplace swap routine.

- A. Both `first` and `last` have value  $k$ , so we are attempting to swap the middle element with itself.
- B. In this case, arguments `x` and `y` to `inplace_swap` both point to the same location. When we compute `*x ^ *y`, we get 0. We then store 0 as the middle element of the array, and the subsequent steps keep setting this element to 0. We can see that our reasoning in [Problem 2.10](#) [↗](#) implicitly assumed that `x` and `y` denote different locations.
- C. Simply replace the test in line 4 of `reverse_array` to be `first < last`, since there is no need to swap the middle element with itself.

# Solution to Problem 2.12 (page 55)

Here are the expressions:

- A. `x & 0xFF`
- B. `x ^ ~0xFF`
- C. `x | 0xFF`

These expressions are typical of the kind commonly found in performing low-level bit operations. The expression `~0xFF` creates a mask where the 8 least-significant bits equal 0 and the rest equal 1. Observe that such a mask will be generated regardless of the word size. By contrast, the expression `0xFFFFFFFF00` would only work when data type `int` is 32 bits.

# Solution to Problem 2.13 (page 56)

These problems help you think about the relation between Boolean operations and typical ways that programmers apply masking operations. Here is the code:

```
|  
/* Declarations of functions implementing operations bis and bic */  
*/  
int bis(int x, int m);  
int bic(int x, int m);  
  
/* Compute x|y using only calls to functions bis and bic */  
int bool_or(int x, int y) {  
    int result = bis(x,y);  
    return result;  
}  
  
/* Compute x^y using only calls to functions bis and bic */  
int bool_xor(int x, int y) {  
    int result = bis(bic(x,y), bic(y,x));  
    return result;  
}
```

The `bis` operation is equivalent to Boolean `OR`—a bit is set in `z` if either this bit is set in `x` or it is set in `m`. On the other hand, `bic(x, m)` is equivalent to `x & ~m`; we want the result to equal 1 only when the corresponding bit of `x` is 1 and of `m` is 0.

Given that, we can implement `|` with a single call to `bis`. To implement `^`, we take advantage of the property

$$x \wedge y = (x \& \sim y) \ (\sim x \& y)$$

## Solution to Problem 2.14 [▣](#)(page 57)

This problem highlights the relation between bit-level Boolean operations and logical operations in C. A common programming error is to use a bit-level operation when a logical one is intended, or vice versa.

## Solution to Problem 2.15 [\(page 57\)](#)

The expression is `!(x ^ y)`.

That is, `x^y` will be zero if and only if every bit of `x` matches the corresponding bit of `y`. We then exploit the ability of `!` to determine whether a word contains any nonzero bit.

There is no real reason to use this expression rather than simply writing `x == y`, but it demonstrates some of the nuances of bit-level and logical operations.

## Solution to Problem 2.16 [\(page 58\)](#)

This problem is a drill to help you understand the different shift operations.

## Solution to Problem 2.17 [↗](#)(page 65)

In general, working through examples for very small word sizes is a very good way to understand computer arithmetic.

The unsigned values correspond to those in [Figure 2.2](#) [↗](#). For the two's-complement values, hex digits [0](#) through [7](#) have a most significant bit of 0, yielding nonnegative values, while hex digits [8](#) through [F](#) have a most significant bit of 1, yielding a negative value.

## Solution to Problem 2.18 (page 69)

For a 32-bit word, any value consisting of 8 hexadecimal digits beginning with one of the digits `8` through `f` represents a negative number. It is quite common to see numbers beginning with a string of `f`'s, since the leading bits of a negative number are all ones. You must look carefully, though. For example, the number `0x8048337` has only 7 digits. Filling this out with a leading zero gives `0x08048337`, a positive number.

4004d0: 48 81 ec e0 02 00 00	sub	
\$0x2e0,%rsp		A. 736
4004d7: 48 8b 44 24 a8	mov	-
0x58(%rsp),%rax		B. -88
4004dc: 48 03 47 28	add	
0x28(%rdi),%rax		C. 40
4004e0: 48 89 44 24 d0	mov	%rax,-
0x30(%rsp)		D. -48
4004e5: 48 8b 44 24 78	mov	
0x78(%rsp),%rax		E. 120
4004ea: 48 89 87 88 00 00 00	mov	
%rax,0x88(%rdi)		F. 136
4004f1: 48 8b 84 24 f8 01 00	mov	
0x1f8(%rsp),%rax		G. 504
4004f8: 00		
4004f9: 48 03 44 24 08	add	
0x8(%rsp),%rax		
4004fe: 48 89 84 24 c0 00 00	mov	
%rax,0xc0(%rsp)		H. 192
400505: 00		
400506: 48 8b 44 d4 b8	mov	
-0x48(%rsp,%rdx,8),%rax		I. -72



## Solution to Problem 2.19 (page 71)

The functions  $T2U$  and  $U2T$  are very peculiar from a mathematical perspective. It is important to understand how they behave.

We solve this problem by reordering the rows in the solution of [Problem 2.17](#) according to the two's-complement value and then listing the unsigned value as the result of the function application. We show the hexadecimal values to make this process more concrete.

## Solution to Problem 2.20 (page 73)

This exercise tests your understanding of [Equation 2.5](#).

For the first four entries, the values of  $x$  are negative and  $T2U_4(x) = x + 2^4$ .

For the remaining two entries, the values of  $x$  are nonnegative and  $T2U_4(x) = x$ .

## Solution to Problem 2.21 (page 76)

This problem reinforces your understanding of the relation between two's-complement and unsigned representations, as well as the effects of the C promotion rules. Recall that  $TMin_{32}$  is  $-2,147,483,648$ , and that when cast to unsigned it becomes  $2,147,483,648$ . In addition, if either operand is unsigned, then the other operand will be cast to unsigned before comparing.

## Solution to Problem 2.22 (page 79)

This exercise provides a concrete demonstration of how sign extension preserves the numeric value of a two's-complement representation.

## Solution to Problem 2.23 (page 80)

The expressions in these functions are common program “idioms” for extracting values from a word in which multiple bit fields have been packed. They exploit the zero-filling and sign-extending properties of the different shift operations. Note carefully the ordering of the cast and shift operations. In `fun1`, the shifts are performed on unsigned variable word and hence are logical. In `fun2`, shifts are performed after casting `word` to `int` and hence are arithmetic.

- B. Function `fun1` extracts a value from the low-order 8 bits of the argument, giving an integer ranging between 0 and 255.
- A. Function `fun2` extracts a value from the low-order 8 bits of the argument, but it also performs sign extension. The result will be a number between  $-128$  and  $127$ .

# Solution to Problem 2.24 (page 82)

The effect of truncation is fairly intuitive for unsigned numbers, but not for two's-complement numbers. This exercise lets you explore its properties using very small word sizes.

As [Equation 2.9](#) states, the effect of this truncation on unsigned values is to simply find their residue, modulo 8. The effect of the truncation on signed values is a bit more complex. According to [Equation 2.10](#), we first compute the modulo 8 residue of the argument. This will give values 0 through 7 for arguments 0 through 7, and also for arguments  $-8$  through  $-1$ . Then we apply function  $U2T_3$  to these residues, giving two repetitions of the sequences 0 through 3 and  $-4$  through  $-1$ .

# Solution to Problem 2.25 (page 83)

This problem is designed to demonstrate how easily bugs can arise due to the implicit casting from signed to unsigned. It seems quite natural to pass parameter `length` as an unsigned, since one would never want to use a negative length. The stopping criterion `i <= length-1` also seems quite natural. But combining these two yields an unexpected outcome!

Since parameter `length` is unsigned, the computation `0 - 1` is performed using unsigned arithmetic, which is equivalent to modular addition. The result is then `UMax`. The `<=` comparison is also performed using an unsigned comparison, and since any number is less than or equal to `UMax`, the comparison always holds! Thus, the code attempts to access invalid elements of array `a`.

The code can be fixed either by declaring `length` to be an `int` or by changing the test of the `for` loop to be `i < length`.

# Solution to Problem 2.26 (page 83)

This example demonstrates a subtle feature of unsigned arithmetic, and also the property that we sometimes perform unsigned arithmetic without realizing it. This can lead to very tricky bugs.

- A. *For what cases will this function produce an incorrect result?*  
The function will incorrectly return 1 when `s` is shorter than `t`.
- B. *Explain how this incorrect result comes about.* Since `strlen` is defined to yield an unsigned result, the difference and the comparison are both computed using unsigned arithmetic. When `s` is shorter than `t`, the difference `strlen(s) - strlen(t)` should be negative, but instead becomes a large, unsigned number, which is greater than 0.
- C. *Show how to fix the code so that it will work reliably.* Replace the test with the following:

```
return strlen(s) > strlen(t);
```

## Solution to Problem 2.27 [\(page 89\)](#)

This function is a direct implementation of the rules given to determine whether or not an unsigned addition overflows.

```
/* Determine whether arguments can be added without overflow */
int uadd_ok(unsigned x, unsigned y) {
    unsigned sum = x+y;
    return sum >= x;
}
```

## Solution to Problem 2.28 [\(page 89\)](#)

This problem is a simple demonstration of arithmetic modulo 16. The easiest way to solve it is to convert the hex pattern into its unsigned decimal value. For nonzero values of  $x$ , we must have  $(-\frac{u}{4}x) + x = 16$ . Then we convert the complemented value back to hex.

## Solution to Problem 2.29 [\(page 93\)](#)

This problem is an exercise to make sure you understand two's-complement addition.

## Solution to Problem 2.30 [\(page 94\)](#)

This function is a direct implementation of the rules given to determine whether or not a two's-complement addition overflows.

```
|  
/* Determine whether arguments can be added without overflow */  
int tadd_ok(int x, int y) {  
    int sum = x+y;  
    int neg_over = x < 0 && y < 0 && sum >= 0;  
    int pos_over = x >= 0 && y >= 0 && sum < 0;  
    return !neg_over && !pos_over;  
}
```



## Solution to Problem 2.31 (page 94)

Your coworker could have learned, by studying [Section 2.3.2](#), that two's-complement addition forms an abelian group, and so the expression  $(x+y)-x$  will evaluate to  $y$  regardless of whether or not the addition overflows, and that  $(x+y)-y$  will always evaluate to  $x$ .

## Solution to Problem 2.32 (page 94)

This function will give correct values, except when  $y$  is  $TMin$ . In this case, we will have  $-y$  also equal to  $TMin$ , and so the call to function `tadd_ok` will indicate overflow when  $x$  is negative and no overflow when  $x$  is nonnegative. In fact, the opposite is true: `tsub_ok(x, TMin)` should yield 0 when  $x$  is negative and 1 when it is nonnegative.

One lesson to be learned from this exercise is that  $TMin$  should be included as one of the cases in any test procedure for a function.

## Solution to Problem 2.33 ◻(page 95)

This problem helps you understand two's-complement negation using a very small word size.

For  $w = 4$ , we have  $TMin_4 = -8$ . So  $-8$  is its own additive inverse, while other values are negated by integer negation.

The bit patterns are the same as for unsigned negation.

## Solution to Problem 2.34 ◻(page 98)

This problem is an exercise to make sure you understand two's-complement multiplication.

# Solution to Problem 2.35 (page 99)

It is not realistic to test this function for all possible values of `x` and `y`. Even if you could run 10 billion tests per second, it would require over 58 years to test all combinations when data type `int` is 32 bits. On the other hand, it is feasible to test your code by writing the function with data type `short` or `char` and then testing it exhaustively.

Here's a more principled approach, following the proposed set of arguments:

1. We know that  $x \cdot y$  can be written as a  $2w$ -bit two's-complement number. Let  $u$  denote the unsigned number represented by the lower  $w$  bits, and  $v$  denote the two's-complement number represented by the upper  $w$  bits. Then, based on [Equation 2.3](#), we can see that  $x \cdot y = v2^w + u$ . We also know that  $u = T2U_w(p)$ , since they are unsigned and two's-complement numbers arising from the same bit pattern, and so by [Equation 2.6](#), we can write  $u = p + p_{w-1}2^w$ , where  $p_{w-1}$  is the most significant bit of  $p$ . Letting  $t = v + p_{w-1}$ , we have  $x \cdot y = p + t2^w$ .

When  $t = 0$ , we have  $x \cdot y = p$ ; the multiplication does not overflow. When  $t = 1$ , we have  $x \cdot y = p + 2^w$ ; the multiplication does overflow.

2. By definition of integer division, dividing  $p$  by nonzero  $x$  gives a quotient  $q$  and a remainder  $r$  such that  $p = x \cdot q + r$ , and  $|r| < |x|$ . (We use absolute values here, because the signs of  $x$  and  $r$  may differ. For example, dividing  $-7$  by  $2$  gives quotient  $-3$  and remainder  $-1$ .)
3. Suppose  $q = y$ . Then we have  $x \cdot y = x \cdot y + r + t2^w$ . From this, we can see that  $r + t2^w = 0$ . But  $|r| < |x| \leq 2^w$ , and so this identity can hold only if  $t = 0$ , in which case  $r = 0$ .  
Suppose  $r = t = 0$ . Then we will have  $x \cdot y = x \cdot q$ , implying that  $y = q$ .

When  $x$  equals  $0$ , multiplication does not overflow, and so we see that our code provides a reliable way to test whether or not two's-complement multiplication causes overflow.

## Solution to Problem 2.36 (page 99)

With 64 bits, we can perform the multiplication without overflowing. We then test whether casting the product to 32 bits changes the value:

```
1      /* Determine whether the arguments can be multiplied
2          without overflow */
3      int tmult_ok(int x, int y) {
4          /* Compute product without overflow */
5          int64_t p11 = (int64_t) x*y;
6          /* See if casting to int preserves value */
7          return p11 == (int) p11;
8      }
```

Note that the casting on the right-hand side of line 5 is critical. If we instead wrote the line as

```
int64_t p11 = x*y;
```

the product would be computed as a 32-bit value (possibly overflowing) and then sign extended to 64 bits.

# Solution to Problem 2.37 (page 99)

- A. This change does not help at all. Even though the computation of `asize` will be accurate, the call to `malloc` will cause this value to be converted to a 32-bit unsigned number, and so the same overflow conditions will occur.
- B. With `malloc` having a 32-bit unsigned number as its argument, it cannot possibly allocate a block of more than  $2^{32}$  bytes, and so there is no point attempting to allocate or copy this much memory. Instead, the function should abort and return `NULL`, as illustrated by the following replacement to the original call to `malloc` (line 9):

```
uint64_t required_size = ele_cnt * (uint64_t) ele_size;
size_t request_size = (size_t) required_size;
if (required_size != request_size)
    /* Overflow must have occurred. Abort operation
    */
    return NULL;
void *result = malloc(request_size);
if (result == NULL)
    /* malloc failed */
    return NULL;
```

## Solution to Problem 2.38 (page 102)

In [Chapter 3](#), we will see many examples of the `LEA` instruction in action. The instruction is provided to support pointer arithmetic, but the C compiler often uses it as a way to perform multiplication by small constants.

For each value of  $k$ , we can compute two multiples:  $2^k$  (when `b` is 0) and  $2^k + 1$  (when `b` is `a`). Thus, we can compute multiples 1, 2, 3, 4, 5, 8, and 9.

## Solution to Problem 2.39 (page 103)

The expression simply becomes  $-(x \ll m)$ . To see this, let the word size be  $w$  so that  $n = w - 1$ . Form B states that we should compute  $(x \ll w) - (x \ll m)$ , but shifting `x` to the left by  $w$  will yield the value 0.

# Solution to Problem 2.40 (page 103)

This problem requires you to try out the optimizations already described and also to supply a bit of your own ingenuity.

Observe that the fourth case uses a modified version of form B. We can view the bit pattern [110111] as having a run of 6 ones with a zero in the middle, and so we apply the rule for form B, but then we subtract the term corresponding to the middle zero bit.



## Solution to Problem 2.41 ◻(page 103)

Assuming that addition and subtraction have the same performance, the rule is to choose form A when  $n = m$ , either form when  $n = m + 1$ , and form B when  $n > m + 1$ .

The justification for this rule is as follows. Assume first that  $m > 0$ . When  $n = m$ , form A requires only a single shift, while form B requires two shifts and a subtraction. When  $n = m + 1$ , both forms require two shifts and either an addition or a subtraction. When  $n > m + 1$ , form B requires only two shifts and one subtraction, while form A requires  $n - m + 1 > 2$  shifts and  $n - m > 1$  additions. For the case of  $m = 0$ , we get one fewer shift for both forms A and B, and so the same rules apply for choosing between the two.

# Solution to Problem 2.42 (page 107)

The only challenge here is to compute the bias without any testing or conditional operations. We use the trick that the expression `x >> 31` generates a word with all ones if `x` is negative, and all zeros otherwise. By masking off the appropriate bits, we get the desired bias value.

```
int div16(int x) {  
    /* Compute bias to be either 0 (x >= 0) or 15 (x < 0) */  
    int bias = (x >> 31) & 0xF;  
    return (x + bias) >> 4;  
}
```

# Solution to Problem 2.43 (page 107)

We have found that people have difficulty with this exercise when working directly with assembly code. It becomes more clear when put in the form shown in `optarith`.

We can see that `M` is `31`; `x*M` is computed as `(x<<5)-x`.

We can see that `N` is 8; a bias value of 7 is added when `y` is negative, and the right shift is by 3.

# Solution to Problem 2.44 (page 108)

These "C puzzle" problems provide a clear demonstration that programmers must understand the properties of computer arithmetic:

A.  $(x > 0) \parallel (x-1 < 0)$

*False.* Let  $x$  be  $-2,147,483,648$  ( $TMin_{32}$ ). We will then have  $x-1$  equal to  $2,147,483,647$  ( $TMax_{32}$ ).

B.  $(x \& 7) != 7 \parallel (x \ll 29 < 0)$

*True.* If  $(x \& 7) != 7$  evaluates to 0, then we must have bit  $x_2$  equal to 1. When shifted left by 29, this will become the sign bit.

C.  $(x * x) >= 0$

*False.* When  $x$  is  $65,535$  ( $0xFFFF$ ),  $x*x$  is  $-131,071$  ( $0xFFFFE0001$ ).

D.  $x < 0 \parallel -x <= 0$

*True.* If  $x$  is nonnegative, then  $-x$  is nonpositive.

E.  $x > 0 \parallel -x >= 0$

*False.* Let  $x$  be  $-2,147,483,648$  ( $TMin_{32}$ ). Then both  $x$  and  $-x$  are negative.

F.  $x+y == uy+ux$

*True.* Two's-complement and unsigned addition have the same bit-level behavior, and they are commutative.

G.  $x * \sim y + uy * ux == -x$

*True.*  $\sim y$  equals  $-y-1$ .  $uy * ux$  equals  $x * y$ . Thus, the left-hand side is equivalent to  $x * -y - x + x * y$ .

## Solution to Problem 2.45 (page 111)

Understanding fractional binary representations is an important step to understanding floating-point encodings. This exercise lets you try out some simple examples.

One simple way to think about fractional binary representations is to represent a number as a fraction of the form  $\frac{x}{2^k}$ . We can write this in binary using the binary representation of  $x$ , with the binary point inserted  $k$  positions from the right. As an example, for  $\frac{25}{16}$ , we have  $25_{10} = 11001_2$ . We then put the binary point four positions from the right to get  $1.1001_2$ .

## Solution to Problem 2.46 ◻(page 111)

In most cases, the limited precision of floating-point numbers is not a major problem, because the *relative* error of the computation is still fairly low. In this example, however, the system was sensitive to the *absolute* error.

A. We can see that  $0.1_{10}$  has the binary representation

$$0.00000000000000000000000001100 [1100] \dots_2$$

B. Comparing this to the binary representation of  $\frac{1}{10}$ , we can see that it is simply  $2^{-20} \times \frac{1}{10}$ , which is around  $9.54 \times 10^{-8}$ .

C.  $9.54 \times 10^{-8} \times 100 \times 60 \times 60 \times 10 \approx 0.343$  seconds.

D.  $0.343 \times 2,000 \approx 687$  meters.

## Solution to Problem 2.47 ◻(page 117)

Working through floating-point representations for very small word sizes helps clarify how IEEE floating point works. Note especially the transition between denormalized and normalized values.

# Solution to Problem 2.48 (page 119)

Hexadecimal `0x359141` is equivalent to binary `[1101011001000101000001]`. Shifting this right 21 places gives  $1.101011001000101000001_2 \times 2^{21}$ . We form the fraction field by dropping the leading 1 and adding two zeros, giving

`[10101100100010100000100]`

The exponent is formed by adding bias 127 to 21, giving 148 (binary `[10010100]`). We combine this with a sign field of 0 to give a binary representation

`[01001010010101100100010100000100]`

We see that the matching bits in the two representations correspond to the low-order bits of the integer, up to the most significant bit equal to 1 matching the high-order 21 bits of the fraction:

```

  0  0  3  5  9  1  4  1
00000000001101011001000101000001
          *****
  4  A  5  6  4  5  0  4
01001010010101100100010100000100
```

## Solution to Problem 2.49 □(page 120)

This exercise helps you think about what numbers cannot be represented exactly in floating point.

- A. The number has binary representation 1, followed by  $n$  zeros, followed by 1, giving value  $2^{n+1} + 1$ .
- B. When  $n = 23$ , the value is  $2^{24} + 1 = 16,777,217$ .

## Solution to Problem 2.50 □(page 121)

Performing rounding by hand helps reinforce the idea of round-to-even with binary numbers.



## Solution to Problem 2.51 □(page 122)

A. Looking at the nonterminating sequence for  $\frac{1}{10}$ , we see that the 2 bits to the right of the rounding position are 1, so a better approximation to  $\frac{1}{10}$  would be obtained by incrementing  $x$  to get  $x' = 0.00011001100110011001101_2$ , which is larger than 0.1.

B. We can see that  $x' - 0.1$  has binary representation

$$0.00000000000000000000000000000[1100]$$

Comparing this to the binary representation of  $\frac{1}{10}$ , we can see that it is  $2^{-22} \times 2^{-22} \times \frac{1}{10}$ , which is around  $2.38 \times 10^{-8}$ .

C.  $2.38 \times 10^{-8} \times 100 \times 60 \times 60 \times 10 \approx 0.086$  seconds, a factor of 4 less than the error in the Patriot system.

D.  $0.086 \times 2,000 \approx 171$  meters.

## Solution to Problem 2.52 □(page 122)

This problem tests a lot of concepts about floating-point representations, including the encoding of normalized and denormalized values, as well as rounding.

# Solution to Problem 2.53 [\(page 125\)](#)

In general, it is better to use a library macro rather than inventing your own code. This code seems to work on a variety of machines, however.

We assume that the value `1e400` overflows to infinity.

```
|  
#define POS_INFINITY 1e400  
#define NEG_INFINITY (-POS_INFINITY)  
#define NEG_ZERO (-1.0/POS_INFINITY)
```

# Solution to Problem 2.54 (page 125)

Exercises such as this one help you develop your ability to reason about floating-point operations from a programmer's perspective. Make sure you understand each of the answers.

A. `x == (int)(double) x`

Yes, since `double` has greater precision and range than `int`.

B. `x == (int)(float) x`

No. For example, when `x` is `TMax`.

C. `d == (double)(float) d`

No. For example, when `d` is `1e40`, we will get `+∞` on the right.

D. `f ==(float)(double) f`

Yes, since `double` has greater precision and range than `float`.

E. `f == -(-f)`

Yes, since a floating-point number is negated by simply inverting its sign bit.

F. `1.0/2 == 1/2.0`

Yes, the numerators and denominators will both be converted to floating-point representations before the division is performed.

G. `d*d >= 0.0`

Yes, although it may overflow to `+∞`.

H. `(f+d)-f == d`

No. For example, when `f` is `1.0e20` and `d` is `1.0`, the expression `f+d` will be rounded to `1.0e20`, and so the expression on the left-hand side will evaluate to `0.0`, while the right-hand side will be `1.0`.

[OceanofPDF.com](http://OceanofPDF.com)

---

# Chapter **3** Machine-Level Representation of Programs

---

<b>3.1 A Historical Perspective</b>	<b>166</b>	
<b>3.2 Program Encodings</b>	<b>169</b>	
<b>3.3 Data Formats</b>	<b>177</b>	
<b>3.4 Accessing Information</b>	<b>179</b>	
<b>3.5 Arithmetic and Logical Operations</b>	<b>191</b>	
<b>3.6 Control</b>	<b>200</b>	
<b>3.7 Procedures</b>	<b>238</b>	
<b>3.8 Array Allocation and Access</b>	<b>255</b>	
<b>3.9 Heterogeneous Data Structures</b>	<b>265</b>	
<b>3.10 Combining Control and Data in Machine-Level Programs</b>	<b>276</b>	
<b>3.11 Floating-Point Code</b>	<b>293</b>	
<b>3.12 Summary</b>	<b>309</b>	
<b>Bibliographic Notes</b>	<b>310</b>	
<b>Homework Problems</b>	<b>311</b>	
<b>Solutions to Practice Problems</b>	<b>325</b>	

Computers execute machine code, sequences of bytes encoding the low-level operations that manipulate data, manage memory, read and write data on storage devices, and communicate over networks. A compiler generates machine code through a series of stages, based on the rules of the programming language, the instruction set of the target machine, and the conventions followed by the operating system. The gcc C compiler generates its output in the form of assembly code, a textual representation of the machine code giving the individual instructions in the program. Gcc then invokes both an assembler and a linker to generate the executable machine code from the assembly code. In this chapter, we will take a close look at machine code and its human-readable representation as assembly code.

When programming in a high-level language such as C, and even more so in Java, we are shielded from the detailed machine-level implementation of our program. In contrast, when writing programs in assembly code (as was done in the early days of computing) a programmer must specify the low-level instructions the program uses to carry out a computation. Most of the time, it is much more

*productive and reliable to work at the higher level of abstraction provided by a high-level language. The type checking provided by a compiler helps detect many program errors and makes sure we reference and manipulate data in consistent ways. With modern optimizing compilers, the generated code is usually at least as efficient as what a skilled assembly-language programmer would write by hand. Best of all, a program written in a high-level language can be compiled and executed on a number of different machines, whereas assembly code is highly machine specific.*

*So why should we spend our time learning machine code? Even though compilers do most of the work in generating assembly code, being able to read and understand it is an important skill for serious programmers. By invoking the compiler with appropriate command-line parameters, the compiler will generate a file showing its output in assembly-code form. By reading this code, we can understand the optimization capabilities of the compiler and analyze the underlying inefficiencies in the code. As we will experience in **Chapter 5**, programmers seeking to maximize the performance of a critical section of code often*



try different variations of the source code, each time compiling and examining the generated assembly code to get a sense of how efficiently the program will run. Furthermore, there are times when the layer of abstraction provided by a high-level language hides information about the run-time behavior of a program that we need to understand. For example, when writing concurrent programs using a thread package, as covered in **Chapter 12**, it is important to understand how program data are shared or kept private by the different threads and precisely how and where shared data are accessed. Such information is visible at the machine-code level. As another example, many of the ways programs can be attacked, allowing malware to infest a system, involve nuances of the way programs store their run-time control information. Many attacks involve exploiting weaknesses in system programs to overwrite information and thereby take control of the system. Understanding how these vulnerabilities arise and how to guard against them requires a knowledge of the machine-level representation of programs. The need for programmers to learn machine code has shifted over the years from one of being able to write programs directly in assembly code

*to one of being able to read and understand the code generated by compilers.*

*In this chapter, we will learn the details of one particular assembly language and see how C programs get compiled into this form of machine code. Reading the assembly code generated by a compiler involves a different set of skills than writing assembly code by hand. We must understand the transformations typical compilers make in converting the constructs of C into machine code. Relative to the computations expressed in the C code, optimizing compilers can rearrange execution order, eliminate unneeded computations, replace slow operations with faster ones, and even change recursive computations into iterative ones. Understanding the relation between source code and the generated assembly can often be a challenge—it's much like putting together a puzzle having a slightly different design than the picture on the box. It is a form of reverse engineering—trying to understand the process by which a system was created by studying the system and working backward. In this case, the system is a machine-generated assembly-language program, rather than something designed by a human. This simplifies the task of*

*reverse engineering because the generated code follows fairly regular patterns and we can run experiments, having the compiler generate code for many different programs. In our presentation, we give many examples and provide a number of exercises illustrating different aspects of assembly language and compilers. This is a subject where mastering the details is a prerequisite to understanding the deeper and more fundamental concepts. Those who say "I understand the general principles, I don't want to bother learning the details" are deluding themselves. It is critical for you to spend time studying the examples, working through the exercises, and checking your solutions with those provided.*

*Our presentation is based on x86-64, the machine language for most of the processors found in today's laptop and desktop machines, as well as those that power very large data centers and supercomputers. This language has evolved over a long history, starting with Intel Corporation's first 16-bit processor in 1978, through to the expansion to 32 bits, and most recently to 64 bits. Along the way, features have been added to make better use of the available semiconductor technology, and to satisfy the*

*demands of the marketplace. Much of the development has been driven by Intel, but its rival Advanced Micro Devices (AMD) has also made important contributions. The result is a rather peculiar design with features that make sense only when viewed from a historical perspective. It is also laden with features providing backward compatibility that are not used by modern compilers and operating systems. We will focus on the subset of the features used by gcc and Linux. This allows us to avoid much of the complexity and many of the arcane features of x86-64.*

*Our technical presentation starts with a quick tour to show the relation between C, assembly code, and machine code. We then proceed to the details of x86-64, starting with the representation and manipulation of data and the implementation of control. We see how control constructs in C, such as `if`, `while`, and `switch` statements, are implemented. We then cover the implementation of procedures, including how the program maintains a run-time stack to support the*

# *Web Aside ASM:IA32 IA32 programming*

*IA32, the 32-bit predecessor to x86-64, was introduced by Intel in 1985. It served as the machine language of choice for several decades. Most x86 microprocessors sold today, and most operating systems installed on these machines, are designed to run x86-64. However, they can also execute IA32 programs in a backward compatibility mode. As a result, many application programs are still based on IA32. In addition, many existing systems cannot execute x86-64, due to limitations of their hardware or system software. IA32 continues to be an important machine language. You will find that having a background in x86-64 will enable you to learn the IA32 machine language quite readily.*

*passing of data and control between procedures, as well as storage for local variables. Next, we consider how data structures such as arrays, structures, and unions are*

*implemented at the machine level. With this background in machine-level programming, we can examine the problems of out-of-bounds memory references and the vulnerability of systems to buffer overflow attacks. We finish this part of the presentation with some tips on using the GDB debugger for examining the run-time behavior of a machine-level program. The chapter concludes with a presentation on machine-program representations of code involving floating-point data and operations.*

*The computer industry has recently made the transition from 32-bit to 64-bit machines. A 32-bit machine can only make use of around 4 gigabytes ( $2^{32}$  bytes) of random access memory, With memory prices dropping at dramatic rates, and our computational demands and data sizes increasing, it has become both economically feasible and technically desirable to go beyond this limitation. Current 64-bit machines can use up to 256 terabytes ( $2^{48}$  bytes) of memory, and could readily be extended to use up to 16 exabytes ( $2^{64}$  bytes). Although it is hard to imagine having a machine with that much memory, keep in mind that 4 gigabytes seemed like an extreme amount of memory when 32-bit*

*machines became commonplace in the 1970s and 1980s.*

*Our presentation focuses on the types of machine-level programs generated when compiling C and similar programming languages targeting modern operating systems. As a consequence, we make no attempt to describe many of the features of x86-64 that arise out of its legacy support for the styles of programs written in the early days of microprocessors, when much of the code was written manually and where programmers had to struggle with the limited range of addresses allowed by 16-bit machines.*

[OceanofPDF.com](http://OceanofPDF.com)

## 3.1 A Historical Perspective

The Intel processor line, colloquially referred to as x86, has followed a long evolutionary development. It started with one of the first single-chip 16-bit microprocessors, where many compromises had to be made due to the limited capabilities of integrated circuit technology at the time. Since then, it has grown to take advantage of technology improvements as well as to satisfy the demands for higher performance and for supporting more advanced operating systems.

The list that follows shows some models of Intel processors and some of their key features, especially those affecting machine-level programming. We use the number of transistors required to implement the processors as an indication of how they have evolved in complexity. In this table, "K" denotes 1,000 ( $10^3$ ), "M" denotes 1,000,000 ( $10^6$ ), and "G" denotes 1,000,000,000 ( $10^9$ ).

**8086 (1978, 29 K transistors).** One of the first single-chip, 16-bit microprocessors. The 8088, a variant of the 8086 with an 8-bit external bus, formed the heart of the original IBM personal computers. IBM contracted with then-tiny Microsoft to develop the MS-DOS operating system. The original models came with 32,768 bytes of memory and two floppy drives (no hard drive). Architecturally, the machines were limited to a 655,360-byte address space—addresses were only 20 bits long (1,048,576



bytes addressable), and the operating system reserved 393,216 bytes for its own use. In 1980, Intel introduced the 8087 floating-point coprocessor (45 K transistors) to operate alongside an 8086 or 8088 processor, executing the floating-point instructions. The 8087 established the floating-point model for the x86 line, often referred to as "x87."

**80286 (1982, 134 K transistors).** Added more (and now obsolete) addressing modes. Formed the basis of the IBM PC-AT personal computer, the original platform for MS Windows.

**i386 (1985, 275 K transistors).** Expanded the architecture to 32 bits. Added the flat addressing model used by Linux and recent versions of the Windows operating system. This was the first machine in the series that could fully support a Unix operating system.

**i486 (1989, 1.2 M transistors).** Improved performance and integrated the floating-point unit onto the processor chip but did not significantly change the instruction set.

**Pentium (1993, 3.1 M transistors).** Improved performance but only added minor extensions to the instruction set.

**PentiumPro (1995, 5.5 M transistors).** Introduced a radically new processor design, internally known as the *P6* microarchitecture. Added a class of "conditional move" instructions to the instruction set.

**Pentium/MMX (1997, 4.5 M transistors).** Added new class of instructions to the Pentium processor for manipulating vectors of

integers. Each datum can be 1, 2, or 4 bytes long. Each vector totals 64 bits.

**Pentium II (1997, 7 M transistors).** Continuation of the P6 microarchitecture.

**Pentium III (1999, 8.2 M transistors).** Introduced SSE, a class of instructions for manipulating vectors of integer or floating-point data. Each datum can be 1, 2, or 4 bytes, packed into vectors of 128 bits. Later versions of this chip went up to 24 M transistors, due to the incorporation of the level-2 cache on chip.

**Pentium 4 (2000, 42 M transistors).** Extended SSE to SSE2, adding new data types (including double-precision floating point), along with 144 new instructions for these formats. With these extensions, compilers can use SSE instructions, rather than x87 instructions, to compile floating-point code.

**Pentium 4E (2004, 125 M transistors).** Added *hyperthreading*, a method to run two programs simultaneously on a single processor, as well as EM64T, Intel's implementation of a 64-bit extension to IA32 developed by Advanced Micro Devices (AMD), which we refer to as x86-64.

**Core 2 (2006, 291 M transistors).** Returned to a microarchitecture similar to P6. First *multi-core* Intel microprocessor, where multiple processors are implemented on a single chip. Did not support hyperthreading.

**Core i7, Nehalem (2008, 781 M transistors).** Incorporated both hyperthreading and multi-core, with the initial version supporting

two executing programs on each core and up to four cores on each chip.

**Core i7, Sandy Bridge (2011, 1.17 G transistors).** Introduced AVX, an extension of the SSE to support data packed into 256-bit vectors.

**Core i7, Haswell (2013, 1.4 G transistors).** Extended AVX to AVX2, adding more instructions and instruction formats.

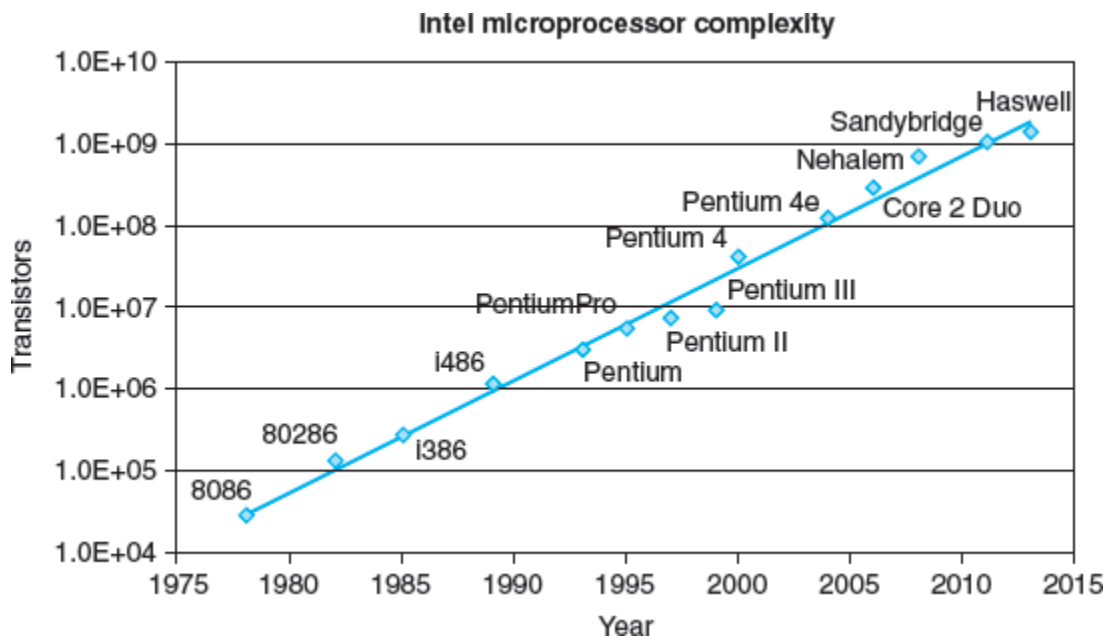
Each successive processor has been designed to be backward compatible—able to run code compiled for any earlier version. As we will see, there are many strange artifacts in the instruction set due to this evolutionary heritage. Intel has had several names for their processor line, including *IA32*, for "Intel Architecture 32-bit" and most recently *Intel64*, the 64-bit extension to IA32, which we will refer to as *x86-64*. We will refer to the overall line by the commonly used colloquial name "x86," reflecting the processor naming conventions up through the i486.

Over the years, several companies have produced processors that are compatible with Intel processors, capable of running the exact same machine-level programs. Chief among these is Advanced Micro Devices (AMD). For years, AMD lagged just behind Intel in technology, forcing a marketing strategy where they produced processors that were less expensive although somewhat lower in performance. They became more competitive around 2002, being the first to break the 1-gigahertz clock-speed barrier for a commercially available microprocessor, and introducing *x86-64*, the

widely adopted 64-bit extension to Intel's IA32. Although we will talk about Intel processors, our presentation holds just as well for the compatible processors produced by Intel's rivals.

Much of the complexity of x86 is not of concern to those interested in programs for the Linux operating system as generated by the `gcc` compiler. The memory model provided in the original 8086 and its extensions in the 80286 became obsolete with the i386. The original x87 floating-point instructions became obsolete

# Aside Moore's Law



If we plot the number of transistors in the different Intel processors versus the year of introduction, and use a logarithmic scale for the y-axis, we can see that the growth has been phenomenal. Fitting a line through the data, we see that the number of transistors increases at an annual rate of approximately 37%, meaning that the number of transistors doubles about every 26 months. This growth has been sustained over the multiple-decade history of x86 microprocessors.

In 1965, Gordon Moore, a founder of Intel Corporation, extrapolated from the chip technology of the day (by which they could fabricate circuits with around 64 transistors on a single chip) to predict that the number of transistors per chip would double every year for the next 10 years. This prediction

became known as *Moore's Law*. As it turns out, his prediction was just a little bit optimistic, but also too short-sighted. Over more than 50 years, the semiconductor industry has been able to double transistor counts on average every 18 months.

Similar exponential growth rates have occurred for other aspects of computer technology, including the storage capacities of magnetic disks and semiconductor memories. These remarkable growth rates have been the major driving forces of the computer revolution.

with the introduction of SSE2. Although we see vestiges of the historical evolution of x86 in x86-64 programs, many of the most arcane features of x86 do not appear.

[OceanofPDF.com](http://OceanofPDF.com)

## 3.2 Program Encodings

Suppose we write a C program as two files `p1.c` and `p2.c`. We can then compile this code using a Unix command line:

```
linux> gcc -Og -o p p1.c p2.c
```

The command `gcc` indicates the `gcc` C compiler. Since this is the default compiler on Linux, we could also invoke it as simply `cc`. The command-line option `-Og`<sup>1</sup> instructs the compiler to apply a level of optimization that yields machine code that follows the overall structure of the original C code. Invoking higher levels of optimization can generate code that is so heavily transformed that the relationship between the generated machine code and the original source code is difficult to understand. We will therefore use `-Og` optimization as a learning tool and then see what happens as we increase the level of optimization. In practice, higher levels of optimization (e.g., specified with the option `-O1` or `-O2`) are considered a better choice in terms of the resulting program performance.

1. This optimization level was introduced in gcc version 4.8. Earlier versions of gcc, as well as non-GNU compilers, will not recognize this option. For these, using optimization level one (specified with the command-line flag `-O1`) is probably the best choice for generating code that follows the original program structure.

The `gcc` command invokes an entire sequence of programs to turn the source code into executable code. First, the *C preprocessor* expands the source code to include any files specified with `#include` commands and to expand any macros, specified with `#define` declarations. Second, the *compiler* generates assembly-code versions of the two source files having names `p1.s` and `p2.s`. Next, the *assembler* converts the assembly code into binary *object-code* files `p1.o` and `p2.o`. Object code is one form of machine code—it contains binary representations of all of the instructions, but the addresses of global values are not yet filled in. Finally, the *linker* merges these two object-code files along with code implementing library functions (e.g., `printf`) and generates the final executable code file `p` (as specified by the command-line directive `-o p`). Executable code is the second form of machine code we will consider—it is the exact form of code that is executed by the processor. The relation between these different forms of machine code and the linking process is described in more detail in [Chapter 7](#).



## 3.2.1 Machine-Level Code

As described in [Section 1.9.3](#), computer systems employ several different forms of abstraction, hiding details of an implementation through the use of a simpler abstract model. Two of these are especially important for machine-level programming. First, the format and behavior of a machine-level program is defined by the *instruction set architecture*, or ISA, defining the processor state, the format of the instructions, and the effect each of these instructions will have on the state. Most ISAs, including x86-64, describe the behavior of a program as if each instruction is executed in sequence, with one instruction completing before the next one begins. The processor hardware is far more elaborate, executing many instructions concurrently, but it employs safeguards to ensure that the overall behavior matches the sequential operation dictated by the ISA. Second, the memory addresses used by a machine-level program are *virtual addresses*, providing a memory model that appears to be a very large byte array. The actual implementation of the memory system involves a combination of multiple hardware memories and operating system software, as described in [Chapter 9](#).

The compiler does most of the work in the overall compilation sequence, transforming programs expressed in the relatively abstract execution model provided by C into the very elementary instructions that the processor executes. The assembly-code representation is very close to machine code. Its main feature is that

it is in a more readable textual format, as compared to the binary format of machine code. Being able to understand assembly code and how it relates to the original C code is a key step in understanding how computers execute programs.

The machine code for x86-64 differs greatly from the original C code. Parts of the processor state are visible that normally are hidden from the C programmer:

- The *program counter* (commonly referred to as the PC, and called `%rip` in x86-64) indicates the address in memory of the next instruction to be executed.
- The integer *register file* contains 16 named locations storing 64-bit values. These registers can hold addresses (corresponding to C pointers) or integer data. Some registers are used to keep track of critical parts of the program state, while others are used to hold temporary data, such as the arguments and local variables of a procedure, as well as the value to be returned by a function.
- The condition code registers hold status information about the most recently executed arithmetic or logical instruction. These are used to implement conditional changes in the control or data flow, such as is required to implement if and while statements.
- A set of vector registers can each hold one or more integer or floating-point values.

Whereas C provides a model in which objects of different data types can be declared and allocated in memory, machine code views the

memory as simply a large byte-addressable array. Aggregate data types in C such as arrays and structures are represented in machine code as contiguous collections of bytes. Even for scalar data types, assembly code makes no distinctions between signed or unsigned integers, between different types of pointers, or even between pointers and integers.

The program memory contains the executable machine code for the program, some information required by the operating system, a run-time stack for managing procedure calls and returns, and blocks of memory allocated by the user (e.g., by using the `malloc` library function). As mentioned earlier, the program memory is addressed using virtual addresses. At any given time, only limited subranges of virtual addresses are considered valid. For example, x86-64 virtual addresses are represented by 64-bit words. In current implementations of these machines, the upper 16 bits must be set to zero, and so an address can potentially specify a byte over a range of  $2^{48}$ , or 64 terabytes. More typical programs will only have access to a few megabytes, or perhaps several gigabytes. The operating system manages

## Aside The ever-changing forms of generated code

In our presentation, we will show the code generated by a particular version of `gcc` with particular settings of the command-line options. If you compile code on your own machine, chances are you will be using a different compiler or a different version of `gcc` and hence will generate different code. The open-source community supporting `gcc` keeps changing the code generator, attempting to generate more efficient code according to changing code guidelines provided by the microprocessor manufacturers.

Our goal in studying the examples shown in our presentation is to demonstrate how to examine assembly code and map it back to the constructs found in high-level programming languages. You will need to adapt these techniques to the style of code generated by your particular compiler.

this virtual address space, translating virtual addresses into the physical addresses of values in the actual processor memory.

A single machine instruction performs only a very elementary operation. For example, it might add two numbers stored in registers, transfer data between memory and a register, or conditionally branch to a new instruction address. The compiler must generate sequences of such instructions to implement program constructs such as arithmetic expression evaluation, loops, or procedure calls and returns.

## 3.2.2 Code Examples

Suppose we write a C code file `mstore.c` containing the following function definition:

```
|  
long mult2(long, long);  
  
void multstore(long x, long y, long *dest) {  
    long t = mult2(x, y);  
    *dest = t;  
}
```

To see the assembly code generated by the C compiler, we can use the `-S` option on the command line:

```
|  
linux> gcc -Og -S mstore.c
```

This will cause `gcc` to run the compiler, generating an assembly file `mstore.s`, and go no further. (Normally it would then invoke the assembler to generate an object-code file.)

The assembly-code file contains various declarations, including the following set of lines:

```
|  
multstore:  
    pushq    %rbx
```

## Aside How do I display the byte representation of a program?

To display the binary object code for a program (say, `mstore`), we use a *disassembler* (described below) to determine that the code for the procedure is 14 bytes long. Then we run the GNU debugging tool `GDB` on file `mstore.o` and give it the command

```
|  
(gdb) x/14xb multstore
```

telling it to display (abbreviated ``x'`) 14 hex-formatted (also ``x'`) bytes (``b'`) starting at the address where function `multstore` is located. You will find that `GDB` has many useful features for analyzing machine-level programs, as will be discussed in [Section 3.10.2](#).

```
|  
movq    %rdx, %rbx  
call    mult2  
movq    %rax, (%rbx)  
popq    %rbx  
ret
```

Each indented line in the code corresponds to a single machine instruction. For example, the `pushq` instruction indicates that the contents of register `%rbx` should be pushed onto the program stack. All information about local variable names or data types has been stripped away.

If we use the `-c` command-line option, `gcc` will both compile and assemble the code

```
|  
linux> gcc -Og -c mstore.c
```

This will generate an object-code file `mstore.o` that is in binary format and hence cannot be viewed directly. Embedded within the 1,368 bytes of the file `mstore.o` is a 14-byte sequence with the hexadecimal representation

```
|  
53 48 89 d3 e8 00 00 00 00 48 89 03 5b c3
```

This is the object code corresponding to the assembly instructions listed previously. A key lesson to learn from this is that the program executed by the machine is simply a sequence of bytes encoding a series of instructions. The machine has very little information about the source code from which these instructions were generated.

To inspect the contents of machine-code files, a class of programs known as *disassemblers* can be invaluable. These programs generate a format similar to assembly code from the machine code. With Linux systems, the program `OBJDUMP` (for "object dump") can serve this role given the `-d` command-line flag:

```
|  
linux> objdump -d mstore.o
```

The result (where we have added line numbers on the left and annotations in italicized text) is as follows:



*Disassembly of function `sum` in binary file `mstore.o`*

```
1 0000000000000000 <multstore>:
```

	<i>Offset</i>	<i>Bytes</i>	<i>Equivalent assembly language</i>
2	0:	53	push %rbx
3	1:	48 89 d3	mov %rdx,%rbx
4	4:	e8 00 00 00 00	callq 9
<i>&lt;multstore+0x9&gt;</i>			
5	9:	48 89 03	mov %rax,(%rbx)
6	c:	5b	pop %rbx
7	d:	c3	retq

On the left we see the 14 hexadecimal byte values, listed in the byte sequence shown earlier, partitioned into groups of 1 to 5 bytes each. Each of these groups is a single instruction, with the assembly-language equivalent shown on the right.

Several features about machine code and its disassembled representation are worth noting:

- x86-64 instructions can range in length from 1 to 15 bytes. The instruction encoding is designed so that commonly used

instructions and those with fewer operands require a smaller number of bytes than do less common ones or ones with more operands.

- The instruction format is designed in such a way that from a given starting position, there is a unique decoding of the bytes into machine instructions. For example, only the instruction `pushq %rbx` can start with byte value `53`.
- The disassembler determines the assembly code based purely on the byte sequences in the machine-code file. It does not require access to the source or assembly-code versions of the program.
- The disassembler uses a slightly different naming convention for the instructions than does the assembly code generated by `gcc`. In our example, it has omitted the suffix ``q'` from many of the instructions. These suffixes are size designators and can be omitted in most cases. Conversely, the disassembler adds the suffix ``q'` to the `call` and `ret` instructions. Again, these suffixes can safely be omitted.

Generating the actual executable code requires running a linker on the set of object-code files, one of which must contain a function `main`. Suppose in file `main.c` we had the following function:

```

|
#include <stdio.h>

void multstore(long, long, long *);

int main() {
    long d;
    multstore(2, 3, &d);
    printf("2 * 3 -> %ld\n", d);
    return 0;
}

long mult2(long a, long b) {
    long s = a * b;
    return s;
}

```

Then we could generate an executable program prog as follows:

```

|
linux> gcc -Og -o prog main.c mstore.c

```

The file `prog` has grown to 8,655 bytes, since it contains not just the machine code for the procedures we provided but also code used to start and terminate the program as well as to interact with the operating system.

We can disassemble the file `prog`:

```
linux> objdump -d prog
```

The disassembler will extract various code sequences, including the following:

```
Disassembly of function sum in binary file prog
1 0000000000400540 <multstore>:
2      400540: 53                push   %rbx
3      400541: 48 89 d3         mov    %rdx,%rbx
4      400544: e8 42 00 00 00   callq 40058b <mult2>
5      400549: 48 89 03         mov    %rax,(%rbx)
6      40054c: 5b                pop    %rbx
7      40054d: c3                retq
8      40054e: 90                nop
9      40054f: 90                nop
```

This code is almost identical to that generated by the disassembly of `mstore.c`. One important difference is that the addresses listed along the left are different—the linker has shifted the location of this code to a different range of addresses. A second difference is that the linker has filled in the address that the `callq` instruction should use in calling the function `mult2` (line 4 of the disassembly). One task for

the linker is to match function calls with the locations of the executable code for those functions. A final difference is that we see two additional lines of code (lines 8-9). These instructions will have no effect on the program, since they occur after the return instruction (line 7). They have been inserted to grow the code for the function to 16 bytes, enabling a better placement of the next block of code in terms of memory system performance.

## 3.2.3 Notes on Formatting

The assembly code generated by `gcc` is difficult for a human to read. On one hand, it contains information with which we need not be concerned, while on the other hand, it does not provide any description of the program or how it works. For example, suppose we give the command

```
linux> gcc -Og -S mstore.c
```

to generate the file `mstore.s`. The full content of the file is as follows:

```
|  
    .file    "010-mstore.c"  
    .text  
    .globl  multstore  
    .type   multstore, @function  
multstore:  
    pushq  %rbx  
    movq   %rdx, %rbx  
    call   mult2  
    movq   %rax, (%rbx)  
    popq   %rbx  
    ret  
    .size  multstore, .-multstore  
    .ident "GCC: (Ubuntu 4.8.1-2ubuntu1~12.04) 4.8.1"  
    .section          .note.GNU-stack,"",@progbits
```

All of the lines beginning with `.' are directives to guide the assembler and linker. We can generally ignore these. On the other hand, there are no explanatory remarks about what the instructions do or how they relate to the source code.

To provide a clearer presentation of assembly code, we will show it in a form that omits most of the directives, while including line numbers and explanatory annotations. For our example, an annotated version would appear as follows:

```
|
|   void multstore(long x, long y, long *dest)
|   x in %rdi, y in %rsi, dest in %rdx
1  multstore:
2  pushq   %rbx           Save %rbx
3  movq    %rdx, %rbx     Copy dest to %rbx
4  call    mult2          Call mult2(x, y)
5  movq    %rax, (%rbx)   Store result at *dest
6  popq    %rbx           Restore %rbx
7  ret                        Return
```

We typically show only the lines of code relevant to the point being discussed. Each line is numbered on the left for reference and annotated on the right by a brief description of the effect of the instruction and how it relates to the computations of the original C code. This is a stylized version of the way assembly-language programmers format their code.

We also provide Web asides to cover material intended for dedicated machine-language enthusiasts. One Web aside describes IA32 machine code. Having a background in x86-64 makes learning IA32 fairly simple. Another Web aside gives a brief presentation of ways to incorporate assembly code into C programs. For some applications, the programmer must drop down to assembly code to access low-level features of the machine. One approach is to write entire functions in assembly code and combine them with C functions during the linking stage. A



# Aside ATT versus Intel assembly- code formats

In our presentation, we show assembly code in ATT format (named after AT&T, the company that operated Bell Laboratories for many years), the default format for `gcc`, `OBJDUMP`, and the other tools we will consider. Other programming tools, including those from Microsoft as well as the documentation from Intel, show assembly code in *Intel* format. The two formats differ in a number of ways. As an example, `gcc` can generate code in Intel format for the `sum` function using the following command line:

```
linux> gcc -Og -S -masm=intel mstore.c
```

This gives the following assembly code:

```

|
|
|
|
multstore:
    push    rbx
    mov     rbx, rdx
    call   mult2
    mov     QWORD PTR [rbx], rax
    pop     rbx
    ret

```

We see that the Intel and ATT formats differ in the following ways:


- The Intel code omits the size designation suffixes. We see instruction `push` and `mov` instead of `pushq` and `movq`.
- The Intel code omits the `%` character in front of register names, using `rbx` instead of `%rbx`.
- The Intel code has a different way of describing locations in memory—for example, `QWORD PTR [rbx]` rather than `(%rbx)`.
- Instructions with multiple operands list them in the reverse order. This can be very confusing when switching between the two formats.

Although we will not be using Intel format in our presentation, you will encounter it in documentation from Intel and Microsoft.

second is to use gcc's support for embedding assembly code directly within C programs.

[OceanofPDF.com](http://OceanofPDF.com)

## 3.3 Data Formats

Due to its origins as a 16-bit architecture that expanded into a 32-bit one, Intel uses the term "word" to refer to a 16-bit data type. Based on this, they refer to 32-bit quantities as "double words," and 64-bit quantities as "quad words." [Figure 3.1](#)  shows the x86-64 representations used for the primitive data types of C. Standard `int` values are stored as double words (32 bits). Pointers (shown here as `char *`) are stored as 8-byte quad words, as would be expected in a 64-bit machine. With x86-64, data type `long` is implemented with 64 bits, allowing a very wide range of values. Most of our code examples in this chapter use pointers and long data

# Web Aside ASM:EASM Combining assembly code with C programs

Although a C compiler does a good job of converting the computations expressed in a program into machine code, there are some features of a machine that cannot be accessed by a C program. For example, every time an x86-64 processor executes an arithmetic or logical operation, it sets a 1-bit *condition code* flag, named `PF` (for "parity flag"), to 1 when the lower 8 bits in the resulting computation have an even number of ones and to 0 otherwise. Computing this information in C requires at least seven shifting, masking, and `EXCLUSIVE-OR` operations (see [Problem 2.65](#)). Even though the hardware performs this computation as part of every arithmetic or logical operation, there is no way for a C program to determine the value of the `PF` condition code flag. This task can readily be performed by incorporating a small number of assembly-code instructions into the program.

There are two ways to incorporate assembly code into C programs. First, we can write an entire function as a separate assembly-code file and let the assembler and linker combine this with code we have written in C. Second, we can use the *inline assembly* feature of `gcc`, where brief sections of assembly code can be incorporated into a C program using the `asm` directive. This approach has the advantage that it minimizes the amount of machine-specific code.

Of course, including assembly code in a C program makes the code specific to a particular class of machines (such as x86-64), and so it should only be used when the desired feature can only be accessed in this way.

### Figure 3.1 Sizes of C data types in x86-64.

With a 64-bit machine, pointers are 8 bytes long.

types, and so they will operate on quad words. The x86-64 instruction set includes a full complement of instructions for bytes, words, and double words as well.



Floating-point numbers come in two principal formats: single-precision (4-byte) values, corresponding to C data type `float`, and double-precision (8-byte) values, corresponding to C data type `double`. Microprocessors in the x86 family historically implemented all floating-point operations with a special 80-bit (10-byte) floating-point format (see [Problem 2.86](#)). This format can be specified in C programs using the declaration `long double`. We recommend against using this format, however. It is not portable to other classes of machines, and it is typically not implemented with the same high-performance hardware as is the case for single- and double-precision arithmetic.


As the table of [Figure 3.1](#) indicates, most assembly-code instructions generated by `gcc` have a single-character suffix denoting the size of the operand. For example, the data movement instruction has four variants: `movb` (move byte), `movw` (move word), `movl` (move

double word), and `movq` (move quad word). The suffix ``1'` is used for double words, since 32-bit quantities are considered to be "long words." The assembly code uses the suffix ``1'` to denote a 4-byte integer as well as an 8-byte double-precision floating-point number. This causes no ambiguity, since floating-point code involves an entirely different set of instructions and registers.

[OceanofPDF.com](http://OceanofPDF.com)


## 3.4 Accessing Information

An x86-64 central processing unit (CPU) contains a set of 16 *general-purpose registers* storing 64-bit values. These registers are used to store integer data as well as pointers. **Figure 3.2**  diagrams the 16 registers. Their names all begin with `%r`, but otherwise follow multiple different naming conventions, owing to the historical evolution of the instruction set. The original 8086 had eight 16-bit registers, shown in **Figure 3.2**  as registers `%ax` through `%bp`. Each had a specific purpose, and hence they were given names that reflected how they were to be used. With the extension to IA32, these registers were expanded to 32-bit registers, labeled `%eax` through `%ebp`. In the extension to x86-64, the original eight registers were expanded to 64 bits, labeled `%rax` through `%rbp`. In addition, eight new registers were added, and these were given labels according to a new naming convention: `%r8` through `%r15`.

As the nested boxes in **Figure 3.2**  indicate, instructions can operate on data of different sizes stored in the low-order bytes of the 16 registers. Byte-level operations can access the least significant byte, 16-bit operations can access the least significant 2 bytes, 32-bit operations can access the least significant 4 bytes, and 64-bit operations can access entire registers.



In later sections, we will present a number of instructions for copying and generating 1-, 2-, 4-, and 8-byte values. When these instructions have registers as destinations, two conventions arise for what happens to the remaining bytes in the register for instructions that generate less than 8 bytes: Those that generate 1- or 2-byte quantities leave the remaining bytes unchanged. Those that generate 4-byte quantities set the upper 4 bytes of the register to zero. The latter convention was adopted as part of the expansion from IA32 to x86-64.

As the annotations along the right-hand side of [Figure 3.2](#)  indicate, different registers serve different roles in typical programs. Most unique among them is the stack pointer, `%rsp`, used to indicate the end position in the run-time stack. Some instructions specifically read and write this register. The other 15 registers have more flexibility in their uses. A small number of instructions make specific use of certain registers. More importantly, a set of standard programming conventions governs how the registers are to be used for managing the stack, passing function



**Figure 3.2 Integer registers.**

The low-order portions of all 16 registers can be accessed as byte, word (16-bit), double word (32-bit), and quad word (64-bit) quantities.

arguments, returning values from functions, and storing local and temporary data. We will cover these conventions in our presentation, especially in [Section 3.7](#), where we describe the implementation of procedures.

## 3.4.1 Operand Specifiers


Most instructions have one or more *operands* specifying the source values to use in performing an operation and the destination location into which to place the

### Figure 3.3 Operand forms.

Operands can denote immediate (constant) values, register values, or values from memory. The scaling factor  $s$  must be either 1, 2, 4, or 8.

result. x86-64 supports a number of operand forms (see [Figure 3.3](#)). Source values can be given as constants or read from registers or memory. Results can be stored in either registers or memory. Thus, the different operand possibilities can be classified into three types. The first type, *immediate*, is for constant values. In ATT-format assembly code, these are written with a ``$'` followed by an integer using standard C notation—for example, `-$577` or `$0x1F`. Different instructions allow different ranges of immediate values; the assembler will automatically select the most compact way of encoding a value. The second type, *register*, denotes the contents of a register, one of the sixteen 8-, 4-, 2-, or 1-byte low-order portions of the registers for operands having 64, 32, 16, or 8 bits, respectively. In [Figure 3.3](#), we use the notation  $r_a$  to denote an arbitrary register  $a$  and indicate its value with the reference  $R[r_a]$ , viewing the set of registers as an array  $R$  indexed by register identifiers.

The third type of operand is a *memory* reference, in which we access some memory location according to a computed address, often called the *effective address*. Since we view the memory as a large array of bytes, we use the notation  $M_b[Addr]$  to denote a reference to the  $b$ -byte value stored in memory starting at address  $Addr$ . To simplify things, we will generally drop the subscript  $b$ .

As **Figure 3.3**  shows, there are many different *addressing modes* allowing different forms of memory references. The most general form is shown at the bottom of the table with syntax  $Imm(r_b, r_i, s)$ . Such a reference has four components: an immediate offset  $Imm$ , a base register  $r_b$ , an index register  $r_i$ , and a scale factor  $s$ , where  $s$  must be 1, 2, 4, or 8. Both the base and index must be 64-bit registers. The effective address is computed as  $Imm + R[r_b] + R[r_i] \cdot s$ . This general form is often seen when referencing elements of arrays. The other forms are simply special cases of this general form where some of the components are omitted. As we will see, the more complex addressing modes are useful when referencing array and structure elements.


## *Practice Problem 3.1 (solution page **325**)*

Assume the following values are stored at the indicated memory addresses and registers:

Fill in the following table showing the values for the indicated operands:

## 3.4.2 Data Movement Instructions

Among the most heavily used instructions are those that copy data from one location to another. The generality of the operand notation allows a simple data movement instruction to express a range of possibilities that in many machines would require a number of different instructions. We present a number of different data movement instructions, differing in their source and destination types, what conversions they perform, and other side effects they may have. In our presentation, we group the many different instructions into *instruction classes*, where the instructions in a class perform the same operation but with different operand sizes.

**Figure 3.4**  lists the simplest form of data movement instructions—the `mov` class. These instructions copy data from a source location to a destination location, without any transformation. The class consists of four instructions: `movb`, `movw`, `movl`, and `movq`. All four of these instructions have similar effects; they differ primarily in that they operate on data of different sizes: 1, 2, 4, and 8 bytes, respectively.

### Figure 3.4 Simple data movement instructions.

The source operand designates a value that is immediate, stored in a register, or stored in memory. The destination operand designates a location that is either a register or a memory address. x86-64 imposes the restriction that a move instruction cannot have both operands refer to memory locations. Copying a value from one memory location to another requires two instructions—the first to load the source value into a register, and the second to write this register value to the destination. Referring to [Figure 3.2](#), register operands for these instructions can be the labeled portions of any of the 16 registers, where the size of the register must match the size designated by the last character of the instruction (`'b'`, `'w'`, `'l'`, or `'q'`). For most cases, the `mov` instructions will only update the specific register bytes or memory locations indicated by the destination operand. The only exception is that when `movl` has a register as the destination, it will also set the high-order 4 bytes of the register to 0. This exception arises from the convention, adopted in x86-64, that any instruction that generates a 32-bit value for a register also sets the high-order portion of the register to 0.

The following `mov` instruction examples show the five possible combinations of source and destination types. Recall that the source operand comes first and the destination second.



1	<code>movl \$0x4050,%eax</code>	<i>Immediate--Register, 4 bytes</i>
2	<code>movw %bp,%sp</code>	<i>Register--Register, 2 bytes</i>
3	<code>movb (%rdi,%rcx),%al</code>	<i>Memory--Register, 1 byte</i>
4	<code>movb \$-17,( %esp)</code>	<i>Immediate--Memory, 1 byte</i>
5	<code>movq %rax,-12(%rbp)</code>	<i>Register--Memory, 8 bytes</i>

A final instruction documented in [Figure 3.4](#) is for dealing with 64-bit immediate data. The regular `movq` instruction can only have immediate source operands that can be represented as 32-bit two's-complement numbers. This value is then sign extended to produce the 64-bit value for the destination. The `movabsq` instruction can have an arbitrary 64-bit immediate value as its source operand and can only have a register as a destination.

[Figures 3.5](#) and [3.6](#) document two classes of data movement instructions for use when copying a smaller source value to a larger destination. All of these instructions copy data from a source, which can be either a register or stored

# Aside Understanding how data movement changes a destination register

As described, there are two different conventions regarding whether and how data movement instructions modify the upper bytes of a destination register. This distinction is illustrated by the following code sequence:

```
1      movabsq $0x0011223344556677, %rax      %rax =  
0011223344556677  
2      movb    $-1, %al                      %rax =  
00112233445566FF  
3      movw    $-1, %ax                      %rax =  
001122334455FFFF  
4      movl    $-1, %eax                    %rax =  
00000000FFFFFFFF  
5      movq    $-1, %rax                    %rax =  
FFFFFFFFFFFFFFFF
```

In the following discussion, we use hexadecimal notation. In the example, the instruction on line 1 initializes register `%rax` to the pattern `0011223344556677`. The remaining instructions have immediate value `-1` as their source values. Recall that

the hexadecimal representation of  $-1$  is of the form `FF...F`, where the number of `F`'s is twice the number of bytes in the representation. The `movb` instruction (line 2) therefore sets the low-order byte of `%rax` to `FF`, while the `movw` instruction (line 3) sets the low-order 2 bytes to `FFFF`, with the remaining bytes unchanged. The `movl` instruction (line 4) sets the low-order 4 bytes to `FFFFFFFF`, but it also sets the high-order 4 bytes to `00000000`. Finally, the `movq` instruction (line 5) sets the complete register to `FFFFFFFFFFFFFFFF`.

### Figure 3.5 Zero-extending data movement instructions.

These instructions have a register or memory location as the source and a register as the destination.

in memory, to a register destination. Instructions in the `MOVZ` class fill out the remaining bytes of the destination with zeros, while those in the `MOVS` class fill them out by sign extension, replicating copies of the most significant bit of the source operand. Observe that each instruction name has size designators as its final two characters—the first specifying the source size, and the second specifying the destination size. As can be seen, there are three instructions in each of these classes, covering all cases of 1- and 2-byte source sizes and 2- and 4-byte destination sizes, considering only cases where the destination is larger than the source, of course.

### Figure 3.6 Sign-extending data movement instructions.

The `movs` instructions have a register or memory location as the source and a register as the destination. The `cltq` instruction is specific to registers `%eax` and `%rax`.

Note the absence of an explicit instruction to zero-extend a 4-byte source value to an 8-byte destination in [Figure 3.5](#). Such an instruction would logically be named `movz1q`, but this instruction does not exist. Instead, this type of data movement can be implemented using a `movl` instruction having a register as the destination. This technique takes advantage of the property that an instruction generating a 4-byte value with a register as the destination will fill the upper 4 bytes with zeros. Otherwise, for 64-bit destinations, moving with sign extension is supported for all three source types, and moving with zero extension is supported for the two smaller source types.

[Figure 3.6](#) also documents the `cltq` instruction. This instruction has no operands—it always uses register `%eax` as its source and `%rax` as the destination for the sign-extended result. It therefore has the exact same effect as the instruction `movslq %eax, %rax`, but it has a more compact encoding.

## Practice Problem 3.2 (solution page 325)

For each of the following lines of assembly language, determine the appropriate instruction suffix based on the operands. (For example, `mov` can be rewritten as `movb`, `movw`, `movl`, or `movq`.)

```
|  
mov___ %eax, (%rsp)  
mov___ (%rax), %dx  
mov___ $0xFF, %bl  
mov___ (%rsp,%rdx,4), %dl  
mov___ (%rdx), %rax  
mov___ %dx, (%rax)
```

# Aside Comparing byte movement instructions

The following example illustrates how different data movement instructions either do or do not change the high-order bytes of the destination. Observe that the three byte-movement instructions `movb`, `movsbq`, and `movzbq` differ from each other in subtle ways. Here is an example:

```
1      movabsq $0x0011223344556677, %rax      %rax =  
0011223344556677  
2      movb $0xAA, %dl                      %dl = AA  
3      movb %dl,%al                         %rax =  
00112233445566AA  
4      movsbq %dl,%rax                      %rax =  
FFFFFFFFFFFFFFAA  
5      movzbq %dl,%rax                      %rax =  
00000000000000AA
```

In the following discussion, we use hexadecimal notation for all of the values. The first two lines of the code initialize registers `%rax` and `%dl` to `0011223344556677` and `AA`, respectively. The remaining instructions all copy the low-order byte of `%rdx` to the low-order byte of `%rax`. The `movb` instruction (line 3) does not change the other bytes. The

`movsbq` instruction (line 4) sets the other 7 bytes to either all ones or all zeros depending on the high-order bit of the source byte. Since hexadecimal A represents binary value `1010`, sign extension causes the higher-order bytes to each be set to FF. The `movzbb` instruction (line 5) always sets the other 7 bytes to zero.

## *Practice Problem 3.3 (solution page **326**)*

Each of the following lines of code generates an error message when we invoke the assembler. Explain what is wrong with each line.

```
|  
movb $0xF, (%ebx)  
movl %rax, (%rsp)  
movw (%rax), 4(%rsp)  
movb %al, %sl  
movq %rax, $0x123  
movl %eax, %rdx  
movb %si, 8(%rbp)
```

## 3.4.3 Data Movement Example

As an example of code that uses data movement instructions, consider the data exchange routine shown in [Figure 3.7](#), both as C code and as assembly code generated by `gcc`.

As [Figure 3.7\(b\)](#) shows, function exchange is implemented with just three instructions: two data movements (`movq`) plus an instruction to return back to the point from which the function was called (`ret`). We will cover the details of function call and return in [Section 3.7](#). Until then, it suffices to say that arguments are passed to functions in registers. Our annotated assembly code documents these. A function returns a value by storing it in register `%rax`, or in one of the low-order portions of this register.



a. C code

```
|
long exchange(long *xp, long y)
{
    long x = *xp;
    *xp = y;
    return x;
}
```

b. Assembly code

```
|
long exchange(long *xp, long y)
xp in %rdi, y in %rsi
1     exchange:
2     movq    (%rdi), %rax    Get x at xp. Set as
return value.
3     movq    %rsi, (%rdi)    Store y at xp.
4     ret                    Return.
```

**Figure 3.7 C and assembly code for exchange routine.**

Registers `%rdi` and `%rsi` hold parameters `xp` and `y`, respectively.

When the procedure begins execution, procedure parameters `xp` and `y` are stored in registers `%rdi` and `%rsi`, respectively. Instruction 2 then reads `x` from memory and stores the value in register `%rax`, a direct implementation of the operation `x = *xp` in the C program.

Later, register `%rax` will be used to return a value from the function, and so the return value will be `x`. Instruction 3 writes `y` to the memory location designated by `xp` in register `%rdi`, a direct implementation of the operation `*xp = y`. This example illustrates how the `MOV` instructions can be used to read from memory to a register (line 2), and to write from a register to memory (line 3).

Two features about this assembly code are worth noting. First, we see that what we call "pointers" in C are simply addresses. Dereferencing a pointer involves copying that pointer into a register, and then using this register in a memory reference. Second, local variables such as `x` are often kept in registers rather than stored in memory locations. Register access is much faster than memory access.

## Practice Problem 3.4 (solution page 326)

Assume variables `sp` and `dp` are declared with types

```
|  
src_t *sp;  
dest_t *dp;
```

where `src_t` and `dest_t` are data types declared with `typedef`. We wish to use the appropriate pair of data movement instructions to implement the operation

```
|  
*dp = (dest_t) *sp;
```

# New to C? Some examples of pointers

Function exchange ([Figure 3.7\(a\)](#)) provides a good illustration of the use of pointers in C. Argument `xp` is a pointer to a long integer, while `y` is a long integer itself. The statement

```
long x = *xp;
```

indicates that we should read the value stored in the location designated by `xp` and store it as a local variable named `x`. This read operation is known as pointer *dereferencing*. The C operator `*' performs pointer dereferencing. The statement`

```
*xp = y;
```

does the reverse—it writes the value of parameter `y` at the location designated by `xp`. This is also a form of pointer dereferencing (and hence the operator `*`), but it indicates a write operation since it is on the left-hand side of the assignment.

The following is an example of exchange in action:


```
|  
long a = 4;  
long b = exchange(&a, 3);  
printf("a = %ld, b = %ld\n", a, b);
```

This code will print

```
|  
a = 3, b = 4
```

The C operator `&` (called the "address of" operator) *creates* a pointer, in this case to the location holding local variable `a`. Function `exchange` overwrites the value stored in `a` with 3 but returns the previous value, 4, as the function value. Observe how by passing a pointer to `exchange`, it could modify data held at some remote location.

Assume that the values of `sp` and `dp` are stored in registers `%rdi` and `%rsi`, respectively. For each entry in the table, show the two instructions that implement the specified data movement. The first instruction in the sequence should read from memory, do the appropriate conversion, and set the appropriate portion of register `%rax`. The second instruction should then write the appropriate portion of `%rax` to memory. In both cases, the portions may be `%rax`, `%eax`, `%ax`, or `%al`, and they may differ from one another.

Recall that when performing a cast that involves both a size change and a change of "signedness" in C, the operation should change the size first ([Section 2.2.6](#) )

## Practice Problem 3.5 (solution page 327)

You are given the following information. A function with prototype

```
void decode1(long *xp, long *yp, long *zp);
```

is compiled into assembly code, yielding the following:

```
void decode1(long *xp, long *yp, long *zp)
xp in %rdi, yp in %rsi, zp in %rdx
decode1:
    movq (%rdi), %r8
    movq (%rsi), %rcx
    movq (%rdx), %rax
    movq %r8, (%rsi)
    movq %rcx, (%rdx)
    movq %rax, (%rdi)
    ret
```

Parameters `xp`, `yp`, and `zp` are stored in registers `%rdi`, `%rsi`, and `%rdx`, respectively.

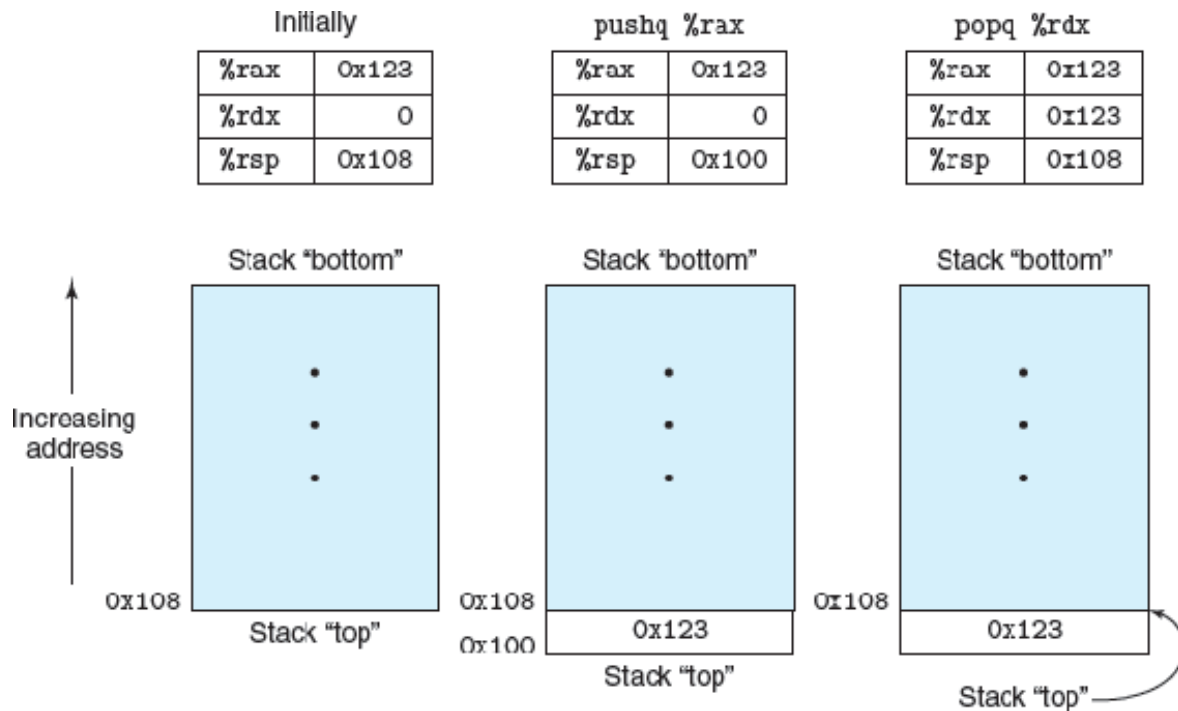
Write C code for `decode1` that will have an effect equivalent to the assembly code shown.

## 3.4.4 Pushing and Popping Stack Data

The final two data movement operations are used to push data onto and pop data from the program stack, as documented in [Figure 3.8](#). As we will see, the stack plays a vital role in the handling of procedure calls. By way of background, a stack is a data structure where values can be added or deleted, but only according to a "last-in, first-out" discipline. We add data to a stack via a *push* operation and remove it via a *pop* operation, with the property that the value popped will always be the value that was most recently pushed and is still on the stack. A stack can be implemented as an array, where we always insert and remove elements from one

**Figure 3.8 Push and pop instructions.**





**Figure 3.9 Illustration of stack operation.**

By convention, we draw stacks upside down, so that the "top" of the stack is shown at the bottom. With x86-64, stacks grow toward lower addresses, so pushing involves decrementing the stack pointer (register `%rsp`) and storing to memory, while popping involves reading from memory and incrementing the stack pointer.

end of the array. This end is called the *top* of the stack. With x86-64, the program stack is stored in some region of memory. As illustrated in [Figure 3.9](#), the stack grows downward such that the top element of the stack has the lowest address of all stack elements. (By convention, we draw stacks upside down, with the stack "top" shown at the bottom of the figure.) The stack pointer `%rsp` holds the address of the top stack element.

The `pushq` instruction provides the ability to push data onto the stack, while the `popq` instruction pops it. Each of these instructions takes a single operand—the data source for pushing and the data destination for popping.

Pushing a quad word value onto the stack involves first decrementing the stack pointer by 8 and then writing the value at the new top-of-stack address. Therefore, the behavior of the instruction `pushq %rbp` is equivalent to that of the pair of instructions

```
subq $8,%rsp      Decrement stack pointer
movq %rbp,( %rsp) Store %rbp on stack
```

except that the `pushq` instruction is encoded in the machine code as a single byte, whereas the pair of instructions shown above requires a total of 8 bytes. The first two columns in [Figure 3.9](#) illustrate the effect of executing the instruction `pushq %rax` when `%rsp` is `0x108` and `%rax` is `0x123`. First `%rsp` is decremented by 8, giving `0x100`, and then `0x123` is stored at memory address `0x100`.



Popping a quad word involves reading from the top-of-stack location and then incrementing the stack pointer by 8. Therefore, the instruction `popq %rax` is equivalent to the following pair of instructions:

```
movq (%rsp),%rax      Read %rax from stack
addq $8,%rsp          Increment stack pointer
```

The third column of [Figure 3.9](#) illustrates the effect of executing the instruction `popq %edx` immediately after executing the `pushq`. Value `0x123` is read from memory and written to register `%rdx`. Register `%rsp` is incremented back to `0x108`. As shown in the figure, the value `0x123` remains at memory location `0x104` until it is overwritten (e.g., by another push operation). However, the stack top is always considered to be the address indicated by `%rsp`.

Since the stack is contained in the same memory as the program code and other forms of program data, programs can access arbitrary positions within the stack using the standard memory addressing methods. For example, assuming the topmost element of the stack is a quad word, the instruction `movq 8(%rsp), %rdx` will copy the second quad word from the stack to register `%rdx`.

## 3.5 Arithmetic and Logical Operations

**Figure 3.10**  lists some of the x86-64 integer and logic operations. Most of the operations are given as instruction classes, as they can have different variants with different operand sizes. (Only `leaq` has no other size variants.) For example, the instruction class `ADD` consists of four addition instructions: `addb`, `addw`, `addl`, and `addq`, adding bytes, words, double words, and quad words, respectively. Indeed, each of the instruction classes shown has instructions for operating on these four different sizes of data. The operations are divided into four groups: load effective address, unary, binary, and shifts. *Binary* operations have two operands, while *unary* operations have one operand. These operands are specified using the same notation as described in **Section 3.4** .

## 3.5.1 Load Effective Address

The *load effective address* instruction `leaq` is actually a variant of the `movq` instruction. It has the form of an instruction that reads from memory to a register,

### Figure 3.10 Integer arithmetic operations.

The load effective address (`leaq`) instruction is commonly used to perform simple arithmetic. The remaining ones are more standard unary or binary operations. We use the notation `>>A` and `>>L` to denote arithmetic and logical right shift, respectively. Note the nonintuitive ordering of the operands with ATT-format assembly code.

but it does not reference memory at all. Its first operand appears to be a memory reference, but instead of reading from the designated location, the instruction copies the effective address to the destination. We indicate this computation in [Figure 3.10](#) using the C address operator `&S`. This instruction can be used to generate pointers for later memory references. In addition, it can be used to compactly describe common arithmetic operations. For example, if register `%rdx` contains value  $x$ , then the instruction `leaq 7(%rdx,%rdx,4), %rax` will set register `%rax` to  $5x + 7$ . Compilers often find clever uses of `leaq` that have nothing to do with effective address computations. The destination operand must be a register.

## *Practice Problem 3.6 (solution page [327](#))*

Suppose register `%rax` holds value  $x$  and `%rcx` holds value  $y$ . Fill in the table below with formulas indicating the value that will be stored in register `%rdx` for each of the given assembly-code instructions:

As an illustration of the use of `leaq` in compiled code, consider the following C program:

```
|
long scale(long x, long y, long z) {
    long t = x + 4 * y + 12 * z;
    return t;
}
```

When compiled, the arithmetic operations of the function are implemented by a sequence of three `leaq` functions, as is documented by the comments on the right-hand side:

```
|
long scale(long x, long y, long z)
x in %rdi, y in %rsi, z in %rdx
scale:
leaq (%rdi,%rsi,4), %rax          x + 4*y
leaq (%rdx,%rdx,2), %rdx         z + 2*z = 3*z
leaq (%rax,%rdx,4), %rax         (x+4*y) + 4*(3*z) = x +
4*y + 12*z
ret
```

The ability of the `leaq` instruction to perform addition and limited forms of multiplication proves useful when compiling simple

arithmetic expressions such as this example.

## *Practice Problem 3.7 (solution page **328**)*

Consider the following code, in which we have omitted the expression being computed:

```
|  
long scale2(long x, long y, long z) {  
    long t = _____;  
    return t;  
}
```

Compiling the actual function with `gcc` yields the following assembly code:

```
|  
long scale2(long x, long y, long z)  
x in %rdi, y in %rsi, z in %rdx  
scale2:  
    leaq (%rdi,%rdi,4), %rax  
    leaq (%rax,%rsi,2), %rax  
    leaq (%rax,%rdx,8), %rax  
    ret
```

Fill in the missing expression in the C code.



## 3.5.2 Unary and Binary Operations

Operations in the second group are unary operations, with the single operand serving as both source and destination. This operand can be either a register or a memory location. For example, the instruction `incq (%rsp)` causes the 8-byte element on the top of the stack to be incremented. This syntax is reminiscent of the C increment (`++`) and decrement (`--`) operators.

The third group consists of binary operations, where the second operand is used as both a source and a destination. This syntax is reminiscent of the C assignment operators, such as `x -= y`.

Observe, however, that the source operand is given first and the destination second. This looks peculiar for noncommutative operations. For example, the instruction `subq %rax,%rdx` decrements register `%rdx` by the value in `%rax`. (It helps to read the instruction as "Subtract `%rax` from `%rdx`.".) The first operand can be either an immediate value, a register, or a memory location. The second can be either a register or a memory location. As with the `MOV` instructions, the two operands cannot both be memory locations. Note that when the second operand is a memory location, the processor must read the value from memory, perform the operation, and then write the result back to memory.



## *Practice Problem 3.8 (solution page **328**)*

Assume the following values are stored at the indicated memory addresses and registers:

Fill in the following table showing the effects of the following instructions, in terms of both the register or memory location that will be updated and the resulting value:

## 3.5.3 Shift Operations

The final group consists of shift operations, where the shift amount is given first and the value to shift is given second. Both arithmetic and logical right shifts are possible. The different shift instructions can specify the shift amount either as an immediate value or with the single-byte register `%cl`. (These instructions are unusual in only allowing this specific register as the operand.) In principle, having a 1-byte shift amount would make it possible to encode shift amounts ranging up to  $2^8 - 1 = 255$ . With x86-64, a shift instruction operating on data values that are  $w$  bits long determines the shift amount from the low-order  $m$  bits of register `%cl`, where  $2^m = w$ . The higher-order bits are ignored. So, for example, when register `%cl` has hexadecimal value `0xFF`, then instruction `salb` would shift by 7, while `salw` would shift by 15, `sall` would shift by 31, and `salq` would shift by 63.

As [Figure 3.10](#)  indicates, there are two names for the left shift instruction: `SAL` and `SHL`. Both have the same effect, filling from the right with zeros. The right shift instructions differ in that `SAR` performs an arithmetic shift (fill with copies of the sign bit), whereas `SHR` performs a logical shift (fill with zeros). The destination operand of a shift operation can be either a register or a memory location. We denote the two different right shift operations in [Figure 3.10](#)  as `>>A` (arithmetic) and `>>L` (logical).

## Practice Problem 3.9 (solution page 328)

Suppose we want to generate assembly code for the following C function:

```
|  
long shift_left4_rightn(long x, long n)  
{  
    x <<= 4;  
    x >>= n;  
    return x;  
}
```

The code that follows is a portion of the assembly code that performs the actual shifts and leaves the final value in register `%rax`. Two key instructions have been omitted. Parameters `x` and `n` are stored in registers `%rdi` and `%rsi`, respectively.

```
|  
long shift_left4_rightn(long x, long n)  
x in %rdi, n in %rsi  
shift_left4_rightn:  
    movq    %rdi, %rax    Get x  
    _____          x <<= 4  
    movl    %esi, %ecx    Get n (4 bytes)  
    _____          x >>= n
```

Fill in the missing instructions, following the annotations on the right. The right shift should be performed arithmetically.

a. C code

```
|  
long arith(long x, long y, long z)  
{  
    long t1 = x ^ y;  
    long t2 = z * 48;  
    long t3 = t1 & 0x0F0F0F0F;  
    long t4 = t2 - t3;  
    return t4;  
}
```

b. Assembly code

```
|  
    long arith(long x, long y, long z)  
    x in %rdi, y in %rsi, z in %rdx  
1      arith:  
2      xorq %rsi, %rdi          t1 = x ^ y  
3      leaq (%rdx,%rdx,2), %rax  3*z  
4      salq $4, %rax           t2 = 16 * (3*z) =  
48*z  
5      andl $252645135, %edi    t3 = t1 &  
0x0F0F0F0F  
6      subq %rdi, %rax         Return t2 - t3  
7      ret
```

Figure 3.11 C and assembly code for arithmetic function.

## 3.5.4 Discussion

We see that most of the instructions shown in [Figure 3.10](#) can be used for either unsigned or two's-complement arithmetic. Only right shifting requires instructions that differentiate between signed versus unsigned data. This is one of the features that makes two's-complement arithmetic the preferred way to implement signed integer arithmetic.

[Figure 3.11](#) shows an example of a function that performs arithmetic operations and its translation into assembly code. Arguments `x`, `y`, and `z` are initially stored in registers `%rdi`, `%rsi`, and `%rdx`, respectively. The assembly-code instructions correspond closely with the lines of C source code. Line 2 computes the value of `x^y`. Lines 3 and 4 compute the expression `z*48` by a combination of `leaq` and shift instructions. Line 5 computes the AND of `t1` and `0x0F0F0F0F`. The final subtraction is computed by line 6. Since the destination of the subtraction is register `%rax`, this will be the value returned by the function.

In the assembly code of [Figure 3.11](#), the sequence of values in register `%rax` corresponds to program values `3*z`, `z*48`, and `t4` (as the return value). In general, compilers generate code that uses individual registers for multiple program values and moves program values among the registers.

## Practice Problem 3.10 (solution page 329)

In the following variant of the function of [Figure 3.11\(a\)](#), the expressions have been replaced by blanks:

```
|  
  
long arith2(long x, long y, long z)  
{  
    longt1= _____;  
    longt2= _____;  
    longt3= _____;  
    longt4= _____;  
    return t4;  
}
```

The portion of the generated assembly code implementing these expressions is as follows:



```
|  
long arith2(long x, long y, long z)  
x in %rdi, y in %rsi, z in %rdx  
arith2:  
    orq  %rsi, %rdi  
    sarq $3, %rdi  
    notq %rdi  
    movq %rdx, %rax  
    subq %rdi, %rax  
    ret
```

Based on this assembly code, fill in the missing portions of the C code.

## Practice Problem 3.11 (solution page 329)

It is common to find assembly-code lines of the form

```
xorq %rdx,%rdx
```

in code that was generated from C where no EXCLUSIVE-OR operations were present.

- A. Explain the effect of this particular EXCLUSIVE-OR instruction and what useful operation it implements.
- B. What would be the more straightforward way to express this operation in assembly code?
- C. Compare the number of bytes to encode these two different implementations of the same operation.

## 3.5.5 Special Arithmetic Operations

As we saw in [Section 2.3](#), multiplying two 64-bit signed or unsigned integers can yield a product that requires 128 bits to represent. The x86-64 instruction set provides limited support for operations involving 128-bit (16-byte) numbers. Continuing with the naming convention of word (2 bytes), double word (4 bytes), and quad word (8 bytes), Intel refers to a 16-byte quantity as an *oct word*.

### Figure 3.12

#### Figure 3.12 Special arithmetic operations.

These operations provide full 128-bit multiplication and division, for both signed and unsigned numbers. The pair of registers `%rdx` and `%rax` are viewed as forming a single 128-bit oct word.

describes instructions that support generating the full 128-bit product of two 64-bit numbers, as well as integer division.

The `imulq` instruction has two different forms. One form, shown in [Figure 3.10](#), is as a member of the `IMUL` instruction class. In this form, it serves as a "two-operand" multiply instruction, generating a 64-bit product from two 64-bit operands. It implements the operations  $*_{64}^u$  and  $*_{64}^t$  described in [Sections 2.3.4](#) and [2.3.5](#). (Recall that when truncating the product to 64 bits, both unsigned

multiply and two's-complement multiply have the same bit-level behavior.)

Additionally, the x86-64 instruction set includes two different "one-operand" multiply instructions to compute the full 128-bit product of two 64-bit values—one for unsigned (`mulq`) and one for two's-complement (`imulq`) multiplication. For both of these instructions, one argument must be in register `%rax`, and the other is given as the instruction source operand. The product is then stored in registers `%rdx` (high-order 64 bits) and `%rax` (low-order 64 bits). Although the name `imulq` is used for two distinct multiplication operations, the assembler can tell which one is intended by counting the number of operands.

As an example, the following C code demonstrates the generation of a 128-bit product of two unsigned 64-bit numbers `x` and `y`:

```
|  
#include <inttypes.h>  
  
typedef unsigned __int128 uint128_t;  
  
void store_uprod(uint128_t *dest, uint64_t x, uint64_t y) {  
    *dest = x * (uint128_t) y;  
}
```

In this program, we explicitly declare `x` and `y` to be 64-bit numbers, using definitions declared in the file `inttypes.h`, as part of an extension of the C standard. Unfortunately, this standard does not make provisions for 128-bit values. Instead, we rely on support provided by `gcc` for 128-bit integers, declared using the name `__int128`. Our code uses a `typedef` declaration to define data type `uint128_t`, following the naming pattern for other data types found in `inttypes.h`. The code specifies that the resulting product should be stored at the 16 bytes designated by pointer `dest`.

The assembly code generated by `gcc` for this function is as follows:

```
|  
|  
| void store_uprod(uint128_t *dest, uint64_t x, uint64_t y)  
| dest in %rdi, x in %rsi, y in %rdx  
1 store_uprod:  
2 movq %rsi, %rax Copy x to multiplicand  
3 mulq %rdx Multiply by y  
4 movq %rax, (%rdi) Store lower 8 bytes at dest  
5 movq %rdx, 8(%rdi) Store upper 8 bytes at dest+8  
6 ret
```

Observe that storing the product requires two `movq` instructions: one for the low-order 8 bytes (line 4), and one for the high-order 8 bytes (line 5). Since the code is generated for a little-endian machine, the

high-order bytes are stored at higher addresses, as indicated by the address specification `8(%rdi)`.

Our earlier table of arithmetic operations ([Figure 3.10](#)) does not list any division or modulus operations. These operations are provided by the single-operand divide instructions similar to the single-operand multiply instructions. The signed division instruction `idivl` takes as its dividend the 128-bit quantity in registers `%rdx` (high-order 64 bits) and `%rax` (low-order 64 bits). The divisor is given as the instruction operand. The instruction stores the quotient in register `%rax` and the remainder in register `%rdx`.

For most applications of 64-bit addition, the dividend is given as a 64-bit value. This value should be stored in register `%rax`. The bits of `%rdx` should then be set to either all zeros (unsigned arithmetic) or the sign bit of `%rax` (signed arithmetic). The latter operation can be performed using the instruction `cqto`.<sup>2</sup> This instruction takes no operands—it implicitly reads the sign bit from `%rax` and copies it across all of `%rdx`.

**2.** This instruction is called `cqo` in the Intel documentation, one of the few cases where the ATT-format name for an instruction does not match the Intel name.

As an illustration of the implementation of division with x86-64, the following C function computes the quotient and remainder of two 64-bit, signed numbers:

```

|
void remdiv(long x, long y,
            long *qp, long *rp) {
    long q = x/y;
    long r = x%y;
    *qp = q;
    *rp = r;
}

```

This compiles to the following assembly code:

```

|
void remdiv(long x, long y, long *qp, long *rp)
x in %rdi, y in %rsi, qp in %rdx, rp in %rcx
1  remdiv:
2  movq %rdx, %r8      Copy qp
3  movq %rdi, %rax     Move x to lower 8 bytes of
dividend
4  cqto               Sign-extend to upper 8 bytes of
dividend
5  idivq %rsi         Divide by y
6  movq %rax, (%r8)   Store quotient at qp
7  movq %rdx, (%rcx) Store remainder at rp
8  ret

```

In this code, argument `rp` must first be saved in a different register (line 2), since argument register `%rdx` is required for the division operation. Lines 3-4 then prepare the dividend by copying and sign-extending `x`. Following the division, the quotient in register `%rax` gets stored at `qp` (line 6), while the remainder in register `%rdx` gets stored at `rp` (line 7).

Unsigned division makes use of the `divq` instruction. Typically, register `%rdx` is set to zero beforehand.

## *Practice Problem 3.12 (solution page 329)*

Consider the following function for computing the quotient and remainder of two unsigned 64-bit numbers:

```
void uremdiv(unsigned long x, unsigned long y,  
             unsigned long *qp, unsigned long *rp) {  
    unsigned long q = x/y;  
    unsigned long r = x%y;  
    *qp = q;  
    *rp = r;  
}
```

Modify the assembly code shown for signed division to implement this function.



[OceanofPDF.com](http://OceanofPDF.com)

## 3.6 Control

So far, we have only considered the behavior of *straight-line* code, where instructions follow one another in sequence. Some constructs in C, such as conditionals, loops, and switches, require conditional execution, where the sequence of operations that get performed depends on the outcomes of tests applied to the data. Machine code provides two basic low-level mechanisms for implementing conditional behavior: it tests data values and then alters either the control flow or the data flow based on the results of these tests.

Data-dependent control flow is the more general and more common approach for implementing conditional behavior, and so we will examine this first. Normally, both statements in C and instructions in machine code are executed *sequentially*, in the order they appear in the program. The execution order of a set of machine-code instructions can be altered with a *jump* instruction, indicating that control should pass to some other part of the program, possibly contingent on the result of some test. The compiler must generate instruction sequences that build upon this low-level mechanism to implement the control constructs of C.

In our presentation, we first cover the two ways of implementing conditional operations. We then describe methods for presenting loops and switch statements.

## 3.6.1 Condition Codes

In addition to the integer registers, the CPU maintains a set of single-bit *condition code* registers describing attributes of the most recent arithmetic or logical operation. These registers can then be tested to perform conditional branches. These condition codes are the most useful:

CF: Carry flag. The most recent operation generated a carry out of the most significant bit. Used to detect overflow for unsigned operations.

ZF: Zero flag. The most recent operation yielded zero.

SF: Sign flag. The most recent operation yielded a negative value.

OF: Overflow flag. The most recent operation caused a two's-complement overflow—either negative or positive.

For example, suppose we used one of the `ADD` instructions to perform the equivalent of the C assignment `t = a+b`, where variables `a`, `b`, and `t` are integers. Then the condition codes would be set according to the following C expressions:

```
CF      (unsigned) t < (unsigned) a      Unsigned overflow
ZF      (t == 0)                        Zero
SF      (t < 0)                          Negative
OF      (a < 0 == b < 0) && (t < 0 != a < 0) Signed overflow
```

The `leaq` instruction does not alter any condition codes, since it is intended to be used in address computations. Otherwise, all of the instructions listed in [Figure 3.10](#) cause the condition codes to be set. For the logical operations, such as `XOR`, the carry and overflow flags are set to zero. For the shift operations, the carry flag is set to the last bit shifted out, while the overflow flag is set to zero. For reasons that we will not delve into, the `INC` and `DEC` instructions set the overflow and zero flags, but they leave the carry flag unchanged.

In addition to the setting of condition codes by the instructions of [Figure 3.10](#), there are two instruction classes (having 8-, 16-, 32-, and 64-bit forms) that set condition codes without altering any other registers; these are listed in [Figure 3.13](#). The `CMP` instructions set the condition codes according to the differences of their two operands. They behave in the same way as the `SUB` instructions, except that they set the condition codes without updating their destinations. With ATT format,

**Figure 3.13 Comparison and test instructions.**

These instructions set the condition codes without updating any other registers.

the operands are listed in reverse order, making the code difficult to read. These instructions set the zero flag if the two operands are equal. The other flags can be used to determine ordering relations between the two operands. The `TEST` instructions behave in the same manner as the `AND` instructions, except that they set the condition codes without altering their destinations. Typically, the same operand is repeated (e.g., `testq %rax,%rax` to see whether `%rax` is negative, zero, or positive), or one of the operands is a mask indicating which bits should be tested.

## 3.6.2 Accessing the Condition Codes

Rather than reading the condition codes directly, there are three common ways of using the condition codes: (1) we can set a single byte to 0 or 1 depending on some combination of the condition codes, (2) we can conditionally jump to some other part of the program, or (3) we can conditionally transfer data. For the first case, the instructions described in [Figure 3.14](#) set a single byte to 0 or to 1 depending on some combination of the condition codes. We refer to this entire class of instructions as the `SET` instructions; they differ from one another based on which combinations of condition codes they consider, as indicated by the different suffixes for the instruction names. It is important to recognize that the suffixes for these instructions denote different conditions and not different operand sizes. For example, instructions `setl` and `setb` denote "set less" and "set below," not "set long word" or "set byte."

A `SET` instruction has either one of the low-order single-byte register elements ([Figure 3.2](#)) or a single-byte memory location as its destination, setting this byte to either 0 or 1. To generate a 32-bit or 64-bit result, we must also clear the high-order bits. A typical instruction sequence to compute the C expression `a < b`, where `a` and `b` are both of type `long`, proceeds as follows:

**Figure 3.14** The `SET` instructions.

Each instruction sets a single byte to 0 or 1 based on some combination of the condition codes. Some instructions have "synonyms," that is, alternate names for the same machine instruction.

```
|
|
| int comp(data_t a, data_t b)
| a in %rdi, b in %rsi
|
1 comp:
2 cmpq %rsi, %rdi Compare a:b
3 setl %al Set low-order byte of %eax to 0 or 1
4 movzbl %al, %eax Clear rest of %eax (and rest of %rax)
5 ret
```

Note the comparison order of the `cmpq` instruction (line 2). Although the arguments are listed in the order `%rsi` (`b`), then `%rdi` (`a`), the comparison is really between `a` and `b`. Recall also, as discussed in [Section 3.4.2](#), that the `movzbl` instruction (line 4) clears not just the high-order 3 bytes of `%eax`, but the upper 4 bytes of the entire register, `%rax`, as well.

For some of the underlying machine instructions, there are multiple possible names, which we list as "synonyms." For example, both `setg` (for "set greater") and `setnle` (for "set not less or equal") refer to the same machine instruction. Compilers and disassemblers make arbitrary choices of which names to use.

Although all arithmetic and logical operations set the condition codes, the descriptions of the different SET instructions apply to the case where a comparison instruction has been executed, setting the condition codes according to the computation  $t = a - b$ . More specifically, let  $a$ ,  $b$ , and  $t$  be the integers represented in two's-complement form by variables  $a$ ,  $b$ , and  $t$ , respectively, and so  $t = a^{-t}_w b$ , where  $w$  depends on the sizes associated with  $a$  and  $b$ .

Consider the `sete`, or "set when equal," instruction. When  $a = b$ , we will have  $t = 0$ , and hence the zero flag indicates equality. Similarly, consider testing for signed comparison with the `setl`, or "set when less," instruction. When no overflow occurs (indicated by having OF set to 0), we will have  $a \geq b$  when  $a^{-t}_w b < 0$ , indicated by having SF set to 1, and  $a < b$  when  $a^{-t}_w b \geq 0$ , indicated by having SF set to 0. On the other hand, when overflow occurs, we will have  $a < b$  when  $a^{-t}_w b > 0$  (negative overflow) and  $a > b$  when  $a^{-t}_w b < 0$  (positive overflow). We cannot have overflow when  $a = b$ . Thus, when OF is set to 1, we will have  $a < b$  if and only if SF is set to 0. Combining these cases, the EXCLUSIVE-OR of the overflow and sign bits provides a test for whether  $a < b$ . The other signed comparison tests are based on other combinations of `SF ^ OF` and `ZF`.

For the testing of unsigned comparisons, we now let  $a$  and  $b$  be the integers represented in unsigned form by variables  $a$  and  $b$ . In performing the computation  $t = a - b$ , the carry flag will be set by the `cmp` instruction when  $a - b < 0$ , and so the unsigned comparisons use combinations of the carry and zero flags.

It is important to note how machine code does or does not distinguish between signed and unsigned values. Unlike in C, it does not associate a data type with each program value. Instead, it mostly uses the same instructions for the two cases, because many arithmetic operations have the same bit-level behavior for unsigned and two's-complement arithmetic. Some circumstances require different instructions to handle signed and unsigned operations, such as using different versions of right shifts, division and multiplication instructions, and different combinations of condition codes.

## Practice Problem 3.13 (solution page 330)

The C code

```
|  
int comp(data_t a, data_t b) {  
    return a COMP b;  
}
```

shows a general comparison between arguments `a` and `b`, where `data_t`, the data type of the arguments, is defined (via `typedef`) to be one of the integer data types listed in [Figure 3.1](#) and either signed or unsigned. The comparison `COMP` is defined via `#define`.

Suppose `a` is in some portion of `%rdx` while `b` is in some portion of `%rsi`. For each of the following instruction sequences, determine which data types `data_t` and which comparisons `COMP` could cause the compiler to generate this code. (There can be multiple correct answers; you should list them all.)

A. |  
`cmpl %esi, %edi`  
`setl %al`

B. |  
`cmpw %si, %di`  
`setge %al`

C. |  
`cmpb %sil, %dil`  
`setbe %al`

D. |  
`cmpq %rsi, %rdi`  
`setne %a`

## Practice Problem 3.14 (solution page 330)

The C code

```
|  
int test(data_t a) {  
    return a TEST 0;  
}
```

shows a general comparison between argument `a` and 0, where we can set the data type of the argument by declaring `data_t` with a `typedef`, and the nature of the comparison by declaring `TEST` with a `#define` declaration. The following instruction sequences implement the comparison, where `a` is held in some portion of register `%rdi`. For each sequence, determine which data types `data_t` and which comparisons `TEST` could cause the compiler to generate this code. (There can be multiple correct answers; list all correct ones.)

A. |  
`testq %rdi, %rdi`  
`setge %al`

B. |  
`testw %di, %di`  
`sete %al`

C. |  
`testb %dil, %dil`  
`seta %al`

D. |  
`testl %edi, %edi`  
`setle %al`



## 3.6.3 Jump Instructions

Under normal execution, instructions follow each other in the order they are listed. A *jump* instruction can cause the execution to switch to a completely new position in the program. These jump destinations are generally indicated in assembly code by a *label*. Consider the following (very contrived) assembly-code sequence:

```
|  
movq $0,%rax      Set %rax to 0  
jmp .L1          Goto .L1  
movq (%rax), %rdx  Null pointer dereference (skipped)  
.L1:  
popq %rdx        Jump target
```

**Figure 3.15** The jump instructions.

These instructions jump to a labeled destination when the jump condition holds. Some instructions have "synonyms," alternate names for the same machine instruction.

The instruction `jmp .L1` will cause the program to skip over the `movq` instruction and instead resume execution with the `popq` instruction. In generating the object-code file, the assembler determines the addresses of all labeled instructions and encodes the *jump targets* (the addresses of the destination instructions) as part of the jump instructions.

**Figure 3.15** shows the different jump instructions. The `jmp` instruction jumps unconditionally. It can be either a *direct* jump, where the jump target is encoded as part of the instruction, or an *indirect* jump, where the jump target is read from a register or a memory location. Direct jumps are written in assembly code by giving a label as the jump target, for example, the label `.L1` in the code shown. Indirect jumps are written using `*` followed by an operand specifier using one of the memory operand formats described in **Figure 3.3**. As examples, the instruction

```
|  
jmp *%rax
```

uses the value in register `%rax` as the jump target, and the instruction

```
jmp *(%rax)
```

reads the jump target from memory, using the value in `%rax` as the read address.

The remaining jump instructions in the table are *conditional*—they either jump or continue executing at the next instruction in the code sequence, depending on some combination of the condition codes. The names of these instructions and the conditions under which they jump match those of the `SET` instructions (see [Figure 3.14](#)). As with the `SET` instructions, some of the underlying machine instructions have multiple names. Conditional jumps can only be direct.

## 3.6.4 Jump Instruction Encodings

For the most part, we will not concern ourselves with the detailed format of machine code. On the other hand, understanding how the targets of jump instructions are encoded will become important when we study linking in [Chapter 7](#). In addition, it helps when interpreting the output of a disassembler. In assembly code, jump targets are written using symbolic labels. The assembler, and later the linker, generate the proper encodings of the jump targets. There are several different encodings for jumps, but some of the most commonly used ones are *PC relative*. That is, they encode the difference between the address of the target instruction and the address of the instruction immediately following the jump. These offsets can be encoded using 1, 2, or 4 bytes. A second encoding method is to give an "absolute" address, using 4 bytes to directly specify the target. The assembler and linker select the appropriate encodings of the jump destinations.

As an example of PC-relative addressing, the following assembly code for a function was generated by compiling a file branch. `c`. It contains two jumps: the `jmp` instruction on line 2 jumps forward to a higher address, while the `jg` instruction on line 7 jumps back to a lower one.

```
|
1   movq %rdi, %rax
2   jmp  .L2
3   .L3:
4   sarq %rax
5   .L2:
6   testq %rax, %rax
7   jg  .L3
8   rep; ret
```

The disassembled version of the `.o` format generated by the assembler is as follows:

```
|
1   0:   48 89 f8   mov    %rdi,%rax
2   3:   eb 03     jmp    8 <loop+0x8>
3   5:   48 d1 f8   sar   %rax
4   8:   48 85 c0   test  %rax,%rax
5   b:   7f f8     jg    5 <loop+0x5>
6   d:   f3 c3     repz retq
```

In the annotations on the right generated by the disassembler, the jump targets are indicated as `0x8` for the jump instruction on line 2 and `0x5` for the jump instruction on line 5 (the disassembler lists all numbers in hexadecimal). Looking at the byte encodings of the instructions, however, we see that the target of the first jump instruction is encoded (in the second byte) as `0x03`. Adding this to `0x5`, the

## Aside What do the instructions `rep` and `repz` do?

Line 8 of the assembly code shown on page 207 contains the instruction combination `rep; ret`. These are rendered in the disassembled code (line 6) as `repz retq`. One can infer that `repz` is a synonym for `rep`, just as `retq` is a synonym for `ret`. Looking at the Intel and AMD documentation for the `rep` instruction, we find that it is normally used to implement a repeating string operation [3, 51]. It seems completely inappropriate here. The answer to this puzzle can be seen in AMD's guidelines to compiler writers [1]. They recommend using the combination of `rep` followed by `ret` to avoid making the `ret` instruction the destination of a conditional jump instruction. Without the `rep` instruction, the `jmp` instruction (line 7 of the assembly code) would proceed to the `ret` instruction when the branch is not taken. According to AMD, their processors cannot properly predict the destination of a `ret` instruction when it is reached from a jump instruction. The `rep` instruction serves as a form of no-operation here, and so inserting it as the jump destination does not change behavior of the code, except to make it faster on AMD processors. We can safely ignore any `rep` or `repz` instruction we see in the rest of the code presented in this book.

address of the following instruction, we get jump target address `0x8`, the address of the instruction on line 4.

Similarly, the target of the second jump instruction is encoded as `0xf8` (decimal `-8`) using a single-byte two's-complement representation. Adding this to `0xd` (decimal `13`), the address of the instruction on line 6, we get `0x5`, the address of the instruction on line 3.

As these examples illustrate, the value of the program counter when performing PC-relative addressing is the address of the instruction following the jump, not that of the jump itself. This convention dates back to early implementations, when the processor would update the program counter as its first step in executing an instruction.

The following shows the disassembled version of the program after linking:

```
|
1 4004d0: 48 89 f8      mov %rdi,%rax
2 4004d3: eb 03        jmp 4004d8 <loop+0x8>
3 4004d5: 48 d1 f8      sar %rax
4 4004d8: 48 85 c0      test %rax,%rax
5 4004db: 7f f8        jg 4004d5 <loop+0x5>
6 4004dd: f3 c3        repz retq
```

The instructions have been relocated to different addresses, but the encodings of the jump targets in lines 2 and 5 remain unchanged. By using a PC-relative encoding of the jump targets, the instructions can be compactly encoded (requiring just 2 bytes), and the object code can be shifted to different positions in memory without alteration.

## Practice Problem 3.15 (solution page 330)

In the following excerpts from a disassembled binary, some of the information has been replaced by X's. Answer the following questions about these instructions.

- A. What is the target of the `je` instruction below? (You do not need to know anything about the `callq` instruction here.)

```
|  
4003fa: 74 02  je      XXXXXX  
4003fc: ff d0  callq   *%rax
```

- B. What is the target of the `je` instruction below?

```
|  
40042f: 74 f4  je      XXXXXX  
400431: 5d     pop     %rbp
```

- C. What is the address of the `ja` and `pop` instructions?

```
|  
XXXXXX: 77 02  ja      400547  
XXXXXX: 5d     pop     %rbp
```

- D. In the code that follows, the jump target is encoded in PC-relative form as a 4-byte two's-complement number. The bytes are listed from least significant to most, reflecting the little-endian byte ordering of x86-64. What is the address of the jump target?

```
|  
4005e8: e9 73 ff ff ff  jmpq   XXXXXXXX  
4005ed: 90             nop
```

The jump instructions provide a means to implement conditional execution (`if`), as well as several different loop constructs.

## 3.6.5 Implementing Conditional Branches with Conditional Control

The most general way to translate conditional expressions and statements from C into machine code is to use combinations of conditional and unconditional jumps. (As an alternative, we will see in [Section 3.6.6](#) that some conditionals can be implemented by conditional transfers of data rather than control.) For example, [Figure 3.16\(a\)](#) shows the C code for a function that computes the absolute value of the difference of two numbers.<sup>3</sup> The function also has a side effect of incrementing one of two counters, encoded as global variables `lt_cnt` and `ge_cnt`. Gcc generates the assembly code shown as [Figure 3.16\(c\)](#). Our rendition of the machine code into C is shown as the function `gotodiff_se` ([Figure 3.16\(b\)](#)). It uses the `goto` statement in C, which is similar to the unconditional jump of

<sup>3</sup> Actually, it can return a negative value if one of the subtractions overflows. Our interest here is to demonstrate machine code, not to implement robust code.

(a) Original C code

```
|
long lt_cnt = 0;
long ge_cnt = 0;
long absdiff_se(long x, long y)
{
    long result;
    if (x < y) {
        lt_cnt++;
        result = y - x;
    }
    else {
        ge_cnt++;
        result = x - y;
    }
    return result;
}
```

(b) Equivalent goto version

```
|
1 long gotodiff_se(long x, long y)
2 {
3     long result;
4     if (x >= y)
5         goto x_ge_y;
6     lt_cnt++;
7     result = y - x;
8     return result;
9 x_ge_y:
10    ge_cnt++;
11    result = x - y;
12    return result;
13 }
```

(c) Generated assembly code



```

long absdiff_se(long x, long y)
x in %rdi, y in %rsi
1  absdiff_se:
2      cmpq    %rsi, %rdi    Compare x:y
3      jge    .L2          If >= goto x_ge_y
4      addq    $1,lt_cnt(%rip) lt_cnt++
5      movq    %rsi, %rax
6      subq    %rdi, %rax    result = y - x
7      ret     Return
8  .L2:          x_ge_y:
9      addq    $1, ge_cnt(%rip) ge_cnt++
10     movq   %rdi, %rax
11     subq   %rsi, %rax    result = x - y
12     ret   Return

```

**Figure 3.16** Compilation of conditional statements.

(a) C procedure `absdiff_se` contains an if-else statement. The generated assembly code is shown (c), along with (b) a C procedure `gotodiff_se` that mimics the control flow of the assembly code.

assembly code. Using `goto` statements is generally considered a bad programming style, since their use can make code very difficult to read and debug. We use them in our presentation as a way to construct C programs that describe the control flow of machine code. We call this style of programming "goto code."

In the goto code ([Figure 3.16\(b\)](#)), the statement `goto x_ge_y` on line 5 causes a jump to the label `x_ge_y` (since it occurs when  $x \geq y$ ) on line 9. Continuing the

## Aside Describing machine code with C code

[Figure 3.16](#) shows an example of how we will demonstrate the translation of C language control constructs into machine code. The figure contains an example C function (a) and an annotated version of the assembly code generated by `gcc` (c). It also contains a version in C that closely matches the structure of the assembly code (b). Although these versions were generated in the sequence (a), (c), and (b), we recommend that you read them in the order (a), (b), and then (c). That is, the C rendition of the machine code will help you understand the key points, and this can guide you in understanding the actual assembly code.

execution from this point, it completes the computations specified by the `else` portion of function `absdiff_se` and returns. On the other hand, if the test  $x \geq y$  fails, the program procedure will carry out the steps specified by the if portion of `absdiff_se` and return.

The assembly-code implementation ([Figure 3.16\(c\)](#)) first compares the two operands (line 2), setting the condition codes. If the comparison result indicates that  $x$  is greater than or equal to  $y$ , it then jumps to a block of code starting at line 8 that increments global variable `ge_cnt`, computes `x-y` as the return value, and returns. Otherwise, it continues with the execution of code beginning at line 4 that increments global variable `lt_cnt`, computes `y-x` as the return value, and returns. We can see, then, that the control flow of the assembly code generated for `absdiff_se` closely follows the goto code of `gotodiff_se`.

The general form of an if-else statement in C is given by the template

```
|  
if (test-expr)  
    then-statement  
else  
    else-statement
```

where `test-expr` is an integer expression that evaluates either to zero (interpreted as meaning "false") or to a nonzero value (interpreted as meaning "true"). Only one of the two branch statements (`then-statement` or `else-statement`) is executed.

For this general form, the assembly implementation typically adheres to the following form, where we use C syntax to describe the control flow:

```
|  
t = test-expr;  
if (!t)  
    goto false;  
    then-statement  
    goto done;  
false:  
    else-statement  
done:
```

That is, the compiler generates separate blocks of code for `then-statement` and `else-statement`. It inserts conditional and unconditional branches to make sure the correct block is executed.

## Practice Problem 3.16 (solution page [331](#))

When given the C code

```
void cond(long a, long *p)
{
    if (p && a > *p)
        *p = a;
}
```

gcc generates the following assembly code:

```
|
| void cond(long a, long *p)
| a in %rdi, p in %rsi
cond:
    testq %rsi, %rsi
    je .L1
    cmpq %rdi, (%rsi)
    jge .L1
    movq %rdi, (%rsi)
.L1:
    rep; ret
```

- A. Write a goto version in C that performs the same computation and mimics the control flow of the assembly code, in the style shown in [Figure 3.16\(b\)](#). You might find it helpful to first annotate the assembly code as we have done in our examples.
- B. Explain why the assembly code contains two conditional branches, even though the C code has only one if statement.

## Practice Problem 3.17 (solution page 331)

An alternate rule for translating `if` statements into goto code is as follows:

```
|  
t = test-expr;  
if (t)  
    goto true;  
else-statement  
goto done;  
true:  
    then-statement  
done:
```

- A. Rewrite the goto version of `absdiff_se` based on this alternate rule.
- B. Can you think of any reasons for choosing one rule over the other?

## Practice Problem 3.18 (solution page [332](#))

Starting with C code of the form

```
|
long test(long x, long y, long z) {
    long val = _____;
    if (_____) {
        if (_____)
            val = _____;
        else
            val = _____;
    } else if (_____)
        val = _____;
    return val;
}
```

gcc generates the following assembly code:

```

long test(long x, long y, long z)
x in %rdi, y in %rsi, z in %rdx
test:
leaq (%rdi,%rsi), %rax
addq %rdx, %rax
cmpq $-3, %rdi
jge .L2
cmpq %rdx, %rsi
jge .L3
movq %rdi, %rax
imulq %rsi, %rax
ret
.L3:
movq %rsi, %rax
imulq %rdx, %rax
ret
.L2:
cmpq $2, %rdi
jle .L4
movq %rdi, %rax
imulq %rdx, %rax
.L4:
rep; ret



```

Fill in the missing expressions in the C code.

## 3.6.6 Implementing Conditional Branches with Conditional Moves

The conventional way to implement conditional operations is through a conditional transfer of *control*, where the program follows one execution path when a condition holds and another when it does not. This mechanism is simple and general, but it can be very inefficient on modern processors.

An alternate strategy is through a conditional transfer of *data*. This approach computes both outcomes of a conditional operation and then selects one based on whether or not the condition holds. This strategy makes sense only in restricted cases, but it can then be implemented by a simple *conditional move* instruction that is better matched to the performance characteristics of modern processors. Here, we examine this strategy and its implementation with x86-64.

**Figure 3.17(a)**  shows an example of code that can be compiled using a conditional move. The function computes the absolute value of its arguments *x* and *y*, as did our earlier example (**Figure 3.16** ). Whereas the earlier example had side effects in the branches, modifying the value of either `lt_cnt` or `ge_cnt`, this version simply computes the value to be returned by the function.

(a) Original C code

```
|
long absdiff(long x, long y)
{
    long result;
    if (x < y)
        result = y - x;
    else
        result = x - y;
    return result;
}
```

(b) Implementation using conditional assignment

```
|
1   long cmovdiff(long x, long y)
2   {
3       long rval = y-x;
4       long eval = x-y;
5       long ntest = x >= y;
6       /* Line below requires
7          single instruction: */
8       if (ntest) rval = eval;
9       return rval;
10  }
```

(c) Generated assembly code



```

long absdiff(long x, long y)
x in %rdi, y in %rsi
1  absdiff:
2  movq   %rsi, %rax
3  subq   %rdi, %rax    rval = y-x
4  movq   %rdi, %rdx
5  subq   %rsi, %rdx    eval = x-y
6  cmpq   %rsi, %rdi    Compare x:y
7  cmovge %rdx, %rax    If >=, rval = eval
8  ret                                Return tval

```

**Figure 3.17 Compilation of conditional statements using conditional assignment.**

(a) C function `absdiff` contains a conditional expression. The generated assembly code is shown (c), along with (b) a C function `cmovdiff` that mimics the operation of the assembly code.

For this function, `gcc` generates the assembly code shown in [Figure 3.17\(c\)](#), having an approximate form shown by the C function `cmovdiff` shown in [Figure 3.17\(b\)](#). Studying the C version, we can see that it computes both `y-x` and `x-y`, naming these `rval` and `eval`, respectively. It then tests whether `x` is greater than or equal to `y`, and if so, copies `eval` to `rval` before returning `rval`. The assembly code in [Figure 3.17\(c\)](#) follows the same logic. The key is that the single `cmovge` instruction (line 7) of the assembly code implements the conditional assignment (line 8) of `cmovdiff`. It will transfer the data from the source register to the destination, only if the `cmpq` instruction of line 6 indicates that one value is greater than or equal to the other (as indicated by the suffix `ge`).

To understand why code based on conditional data transfers can outperform code based on conditional control transfers (as in [Figure 3.16](#)), we must understand something about how modern processors operate. As we will see in [Chapters 4](#) and [5](#), processors achieve high performance through *pipelining*, where an instruction is processed via a sequence of stages, each performing one small portion of the required operations (e.g., fetching the instruction from memory, determining the instruction type, reading from memory, performing an arithmetic operation, writing to memory, and updating the program counter). This approach achieves high performance by overlapping the steps of the successive instructions, such as fetching one instruction while performing the arithmetic operations for a previous instruction. To do this requires being able to determine the sequence of instructions to be executed well ahead of time in order to keep the pipeline full of instructions to be executed. When the machine encounters a conditional jump (referred to as a "branch"), it cannot determine which way the branch will go until it has evaluated the branch condition. Processors employ sophisticated *branch prediction logic* to try to guess whether or not each jump instruction will be followed. As long as it can guess reliably (modern microprocessor designs try to achieve success rates on the order of 90%), the instruction pipeline will be kept full of instructions. Mispredicting a jump, on the other hand, requires that the

processor discard much of the work it has already done on future instructions and then begin filling the pipeline with instructions starting at the correct location. As we will see, such a misprediction can incur a serious penalty, say, 15–30 clock cycles of wasted effort, causing a serious degradation of program performance.

As an example, we ran timings of the `absdiff` function on an Intel Haswell processor using both methods of implementing the conditional operation. In a typical application, the outcome of the test `x < y` is highly unpredictable, and so even the most sophisticated branch prediction hardware will guess correctly only around 50% of the time. In addition, the computations performed in each of the two code sequences require only a single clock cycle. As a consequence, the branch misprediction penalty dominates the performance of this function. For x86-64 code with conditional jumps, we found that the function requires around 8 clock cycles per call when the branching pattern is easily predictable, and around 17.50 clock cycles per call when the branching pattern is random. From this, we can infer that the branch misprediction penalty is around 19 clock cycles. That means time required by the function ranges between around 8 and 27 cycles, depending on whether or not the branch is predicted correctly.

### Aside How did you determine this penalty?

Assume the probability of misprediction is  $p$ , the time to execute the code without misprediction is  $T_{\text{OK}}$ , and the misprediction penalty is  $T_{\text{avg}}(P) = (1 - P)T_{\text{OK}} + T_{\text{MP}} = T_{\text{OK}} + PT_{\text{MP}}$ . We are given  $T_{\text{OK}}$  and  $T_{\text{ran}}$ , the average time when  $p = 0.5$ , and we want to determine  $T_{\text{MP}}$ .

Substituting into the equation, we get

$$T_{\text{ran}} = T_{\text{avg}}(0.5) = T_{\text{OK}} + 0.5T_{\text{MP}}, \text{ and therefore } T_{\text{MP}} = 2(T_{\text{ran}} - T_{\text{OK}}). \text{ So, for } T_{\text{OK}} = 8$$

On the other hand, the code compiled using conditional moves requires around 8 clock cycles regardless of the data being tested. The flow of control does not depend on data, and this makes it easier for the processor to keep its pipeline full.

### Practice Problem 3.19 (solution page 332)

Running on an older processor model, our code required around 16 cycles when the branching pattern was highly predictable, and around 31 cycles when the pattern was random.

- What is the approximate miss penalty?
- How many cycles would the function require when the branch is mispredicted?

**Figure 3.18** illustrates some of the conditional move instructions available with x86-64. Each of these instructions has two operands: a source register or memory location  $S$ , and a destination register  $R$ . As with the different set ([Section 3.6.2](#)) and jump ([Section 3.6.3](#)) instructions, the outcome of these instructions depends on the values of the condition codes. The source value is read from either memory or the source register, but it is copied to the destination only if the specified condition holds.

The source and destination values can be 16, 32, or 64 bits long. Single-byte conditional moves are not supported. Unlike the unconditional instructions, where the operand length is explicitly encoded in the instruction name (e.g., `movw` and `movl`), the assembler can infer the operand length of a conditional move instruction from the name of the destination register, and so the same instruction name can be used for all operand lengths.

Unlike conditional jumps, the processor can execute conditional move instructions without having to predict the outcome of the test. The processor simply reads the source value (possibly from memory), checks the condition code, and then either updates the destination register or keeps it the same. We will explore the implementation of conditional moves in [Chapter 4](#).

To understand how conditional operations can be implemented via conditional data transfers, consider the following general form of conditional expression and assignment:

**Figure 3.18 The conditional move instructions.**

These instructions copy the source value *S* to its destination *R* when the move condition holds. Some instructions have "synonyms," alternate names for the same machine instruction.

```
v = test-expr ? then-expr : else-expr;
```

The standard way to compile this expression using conditional control transfer would have the following form:

```
if (!test-expr)
    goto false;
v = then-expr;
goto done;
false:
v = else-expr;
done:
```

This code contains two code sequences—one evaluating *then-expr* and one evaluating *else-expr*. A combination of conditional and unconditional jumps is used to ensure that just one of the sequences is evaluated.

For the code based on a conditional move, both the *then-expr* and the *else-expr* are evaluated, with the final value chosen based on the evaluation *test-expr*. This can be described by the following abstract code:

```

|
v = then-expr;
ve = else-expr;
t = test-expr;
if (!t) v = ve;

```

The final statement in this sequence is implemented with a conditional move—value `ve` is copied to `v` only if test condition `t` does not hold.

Not all conditional expressions can be compiled using conditional moves. Most significantly, the abstract code we have shown evaluates both *then-expr* and *else-expr* regardless of the test outcome. If one of those two expressions could possibly generate an error condition or a side effect, this could lead to invalid behavior. Such is the case for our earlier example (Figure 3.16). Indeed, we put the side effects into this example specifically to force `gcc` to implement this function using conditional transfers.

As a second illustration, consider the following C function:

```

|
long cread(long *xp) {
    return (xp ? *xp : 0);
}

```

At first, this seems like a good candidate to compile using a conditional move to set the result to zero when the pointer is null, as shown in the following assembly code:

```

|
long cread(long *xp)
Invalid implementation of function cread
xp in register %rdi
1  cread:
2      movq (%rdi), %rax    v = *xp
3      testq %rdi, %rdi    Test x
4      movl $0, %edx       Set ve = 0
5      cmovle %rdx, %rax   If x==0, v = ve
6      ret                Return v

```

This implementation is invalid, however, since the dereferencing of `xp` by the `movq` instruction (line 2) occurs even when the test fails, causing a null pointer dereferencing error. Instead, this code must be

compiled using branching code.

Using conditional moves also does not always improve code efficiency. For example, if either the *then-expr* or the *else-expr* evaluation requires a significant computation, then this effort is wasted when the corresponding condition does not hold. Compilers must take into account the relative performance of wasted computation versus the potential for performance penalty due to branch misprediction. In truth, they do not really have enough information to make this decision reliably; for example, they do not know how well the branches will follow predictable patterns. Our experiments with `gcc` indicate that it only uses conditional moves when the two expressions can be computed very easily, for example, with single add instructions. In our experience, `gcc` uses conditional control transfers even in many cases where the cost of branch misprediction would exceed even more complex computations.

Overall, then, we see that conditional data transfers offer an alternative strategy to conditional control transfers for implementing conditional operations. They can only be used in restricted cases, but these cases are fairly common and provide a much better match to the operation of modern processors.

[OceanofPDF.com](http://OceanofPDF.com)

## Practice Problem 3.20 (solution page 333)

In the following C function, we have left the definition of operation `OP` incomplete:

```
|  
#define OP _____ /* Unknown operator */  
long arith(long x) {  
    return x OP 8;  
}
```

When compiled, `gcc` generates the following assembly code:

```
|  
    long arith(long x)  
    x in %rdi  
arith:  
    leaq 7(%rdi), %rax  
    testq %rdi, %rdi  
    cmovns %rdi, %rax  
    sarq $3, %rax  
    ret
```

- A. What operation is `OP`?
- B. Annotate the code to explain how it works.

## Practice Problem 3.21 (solution page 333)

Starting with C code of the form

```
|
long test(long x, long y) {
    long val = _____;
    if (_____) {
        if (_____)
            val = _____;
        else
            val = _____;
    } else if (_____)
        val = _____;
    return val;
}
```

`gcc` generates the following assembly code:

```

|
long test(long x, long y)
x in %rdi, y in %rsi
test:
    leaq 0(,%rdi,8), %rax
    testq %rsi, %rsi
    jle .L2
    movq %rsi, %rax
    subq %rdi, %rax
    movq %rdi, %rdx
    andq %rsi, %rdx
    cmpq %rsi, %rdi
    cmovge %rdx, %rax
    ret
.L2:
    addq %rsi, %rdi
    cmpq $-2, %rsi
    cmovle %rdi, %rax
    ret

```

Fill in the missing expressions in the C code.



## 3.6.7 Loops

C provides several looping constructs—namely, `do-while`, `while`, and `for`. No corresponding instructions exist in machine code. Instead, combinations of conditional tests and jumps are used to implement the effect of loops. `Gcc` and other compilers generate loop code based on the two basic loop patterns. We will study the translation of loops as a progression, starting with `do-while` and then working toward ones with more complex implementations, covering both patterns.

# Do-While Loops

The general form of a `do-while` statement is as follows:

```
|  
do  
    body-statement  
while (test-expr);
```

The effect of the loop is to repeatedly execute *body-statement*, evaluate *test-expr*, and continue the loop if the evaluation result is nonzero. Observe that *body-statement* is executed at least once.

This general form can be translated into conditionals and `goto` statements as follows:

```
|  
loop:  
    body-statement  
    t = test-expr;  
    if (t)  
        goto loop;
```

That is, on each iteration the program evaluates the body statement and then the test expression. If the test succeeds, the program goes

back for another iteration.

(a) C code

```
|  
long fact_do(long n)  
{  
    long result = 1;  
    do {  
        result *= n;  
        n = n-1;  
    } while (n > 1);  
    return result;  
}
```

(b) Equivalent goto version

```
|  
long fact_do_goto(long n)  
{  
    long result = 1;  
loop:  
    result *= n;  
    n = n-1;  
    if (n > 1)  
        goto loop;  
    return result;  
}
```

(c) Corresponding assembly-language code

```
|
|
|   long fact_do(long n)
|   n in %rdi
1   fact_do:
2       movl $1, %eax           Set result = 1
3       .L2:                    loop:
4       imulq %rdi, %rax       Compute result *= n
5       subq $1, %rdi         Decrement n
6       cmpq $1, %rdi         Compare n:1
7       jg .L2 If >,         goto loop
8       rep; ret              Return
```



**Figure 3.19** Code for `do-while` version of factorial program.

A conditional jump causes the program to loop.

As an example, [Figure 3.19\(a\)](#) shows an implementation of a routine to compute the factorial of its argument, written  $n!$ , with a do-while loop. This function only computes the proper value for  $n > 0$ .

### Practice Problem 3.22 (solution page [333](#))

- A. What is the maximum value of  $n$  for which we can represent  $n!$  with a 32-bit `int`?
- B. What about for a 64-bit `long`?


The goto code shown in [Figure 3.19\(b\)](#)  shows how the loop gets turned into a lower-level combination of tests and conditional jumps. Following the initialization of `result`, the program begins looping. First it executes the body of the loop, consisting here of updates to variables `result` and  $n$ . It then tests whether  $n > 1$ , and, if so, it jumps back to the beginning of the loop. [Figure 3.19\(c\)](#)  shows

## Aside Reverse engineering loops

A key to understanding how the generated assembly code relates to the original source code is to find a mapping between program values and registers. This task was simple enough for the loop of [Figure 3.19](#), but it can be much more challenging for more complex programs. The C compiler will often rearrange the computations, so that some variables in the C code have no counterpart in the machine code, and new values are introduced into the machine code that do not exist in the source code. Moreover, it will often try to minimize register usage by mapping multiple program values onto a single register.

The process we described for `fact_do` works as a general strategy for reverse engineering loops. Look at how registers are initialized before the loop, updated and tested within the loop, and used after the loop. Each of these provides a clue that can be combined to solve a puzzle. Be prepared for surprising transformations, some of which are clearly cases where the compiler was able to optimize the code, and others where it is hard to explain why the compiler chose that particular strategy.

the assembly code from which the goto code was generated. The conditional jump instruction `jg` (line 7) is the key instruction in implementing a loop. It determines whether to continue iterating or to exit the loop.

Reverse engineering assembly code, such as that of **Figure 3.19(c)** , requires determining which registers are used for which program values. In this case, the mapping is fairly simple to determine: We know that  $n$  will be passed to the function in register `%rdi`. We can see register `%rax` getting initialized to 1 (line 2). (Recall that, although the instruction has `%eax` as its destination, it will also set the upper 4 bytes of `%rax` to 0.) We can see that this register is also updated by multiplication on line 4. Furthermore, since `%rax` is used to return the function value, it is often chosen to hold program values that are returned. We therefore conclude that `%rax` corresponds to program value `result`.



## Practice Problem 3.23 (solution page [334](#))

For the C code

```
|  
long dw_loop(long x) {  
    long y = x*x;  
    long *p = &x;  
    long n = 2*x;  
    do {  
        x += y;  
        (*p)++;  
        n--;  
    } while (n > 0);  
    return x;  
}
```

gcc generates the following assembly code:

```

|
|
|   long dw_loop(long x)
|   x initially in %rdi
1   dw_loop:
2   movq %rdi, %rax
3   movq %rdi, %rcx
4   imulq %rdi, %rcx
5   leaq (%rdi,%rdi), %rdx
6   .L2:
7   leaq 1(%rcx,%rax), %rax
8   subq $1, %rdx
9   testq %rdx, %rdx
10  jg .L2
11  rep; ret

```

- A. Which registers are used to hold program values  $x$ ,  $y$ , and  $n$ ?
- B. How has the compiler eliminated the need for pointer variable `p` and the pointer dereferencing implied by the expression `(*p)++`?
- C. Add annotations to the assembly code describing the operation of the program, similar to those shown in [Figure 3.19\(c\)](#).

# While Loops


The general form of a `while` statement is as follows:

```
|  
while (test-expr)  
    body-statement
```

It differs from `do-while` in that *test-expr* is evaluated and the loop is potentially terminated before the first execution of *body-statement*. There are a number of ways to translate a `while loop` into machine code, two of which are used in code generated by `gcc`. Both use the same loop structure as we saw for `do-while loops` but differ in how to implement the initial test.

The first translation method, which we refer to as *jump to middle*, performs the initial test by performing an unconditional jump to the test at the end of the loop. It can be expressed by the following template for translating from the general `while loop` form to `goto` code:

```
|  
    goto test;  
loop:  
    body-statement  
test:  
    t = test-expr;  
    if (t)  
        goto loop;
```

As an example, **Figure 3.20(a)**  shows an implementation of the factorial function using a `while` loop. This function correctly computes  $0! = 1$ . The adjacent

(a) C code

```
|  
long fact_while(long n)  
{  
    long result = 1;  
    while (n > 1) {  
        result *= n;  
        n = n-1;  
    }  
    return result;  
}
```

(b) Equivalent goto version

```
|  
long fact_while_jm_goto(long n)  
{  
    long result = 1;  
    goto test;  
loop:  
    result *= n;  
    n = n-1;  
test:  
    if (n > 1)  
        goto loop;  
    return result;  
}
```

(c) Corresponding assembly-language code

```


|
|
| long fact_while(long n)
| n in %rdi
| fact_while:
|     movl $1, %eax Set result = 1
|     jmp .L5 Goto test
| .L6:          loop:
|     imulq %rdi, %rax Compute result *= n
|     subq $1, %rdi Decrement n
| .L5:          test:
|     cmpq $1, %rdi Compare n:1
|     jg .L6 If >, goto loop
|     rep; ret Return

```

**Figure 3.20 C and assembly code for `while` version of factorial using jump-to-middle translation.**

The C function `fact_while_jm_goto` illustrates the operation of the assembly-code version.

function `fact_while_jm_goto` ([Figure 3.20\(b\)](#)) is a C rendition of the assembly code generated by `gcc` when optimization is specified with the command-line option `-Og`. Comparing the `goto` code generated for `fact_while` ([Figure 3.20\(b\)](#)) to that for `fact_do` ([Figure 3.19\(b\)](#)), we see that they are very similar, except that the statement `goto test` before the loop causes the program to first perform the test of `n` before modifying the values of `result` or `n`.

The bottom portion of the figure ([Figure 3.20\(c\)](#) ) shows the actual assembly code generated.



## Practice Problem 3.24 (solution page [335](#))

For C code having the general form

```
|
long loop_while(long a, long b)
{
long result = _____;
while (_____) {
    result = _____;
    a = _____;
}
return result;
}
```

gcc, run with command-line option `-Og`, produces the following code:

```

|
|
|   long loop_while(long a, long b)
|   a in %rdi, b in %rsi
1   loop_while:
2       movl  $1, %eax
3       jmp   .L2
4       .L3:
5       leaq (%rdi,%rsi), %rdx
6       imulq %rdx, %rax
7       addq  $1, %rdi
8       .L2:
9       cmpq  %rsi, %rdi
10      jl    .L3
11      rep; ret

```

We can see that the compiler used a jump-to-middle translation, using the `jmp` instruction on line 3 to jump to the test starting with label `.L2`. Fill in the missing parts of the C code.

The second translation method, which we refer to as *guarded do*, first transforms the code into a `do-while` loop by using a conditional branch to skip over the loop if the initial test fails. `Gcc` follows this strategy when compiling with higher levels of optimization, for example, with command-line option `-O1`. This method can be

expressed by the following template for translating from the general while loop form to a `do-while` loop:

```
|  
t = test-expr;  
if (!t)  
    goto done;  
do  
    body-statement  
    while (test-expr);  
done:
```

This, in turn, can be transformed into goto code as

```
|  
t = test-expr;  
if (!t)  
    goto done;  
loop:  
    body-statement  
    t = test-expr;  
    if (t)  
        goto loop;  
done:
```

Using this implementation strategy, the compiler can often optimize the initial test, for example, determining that the test condition will always hold.

As an example, [Figure 3.21](#) shows the same C code for a factorial function as in [Figure 3.20](#), but demonstrates the compilation that occurs when `gcc` is given command-line option `-O1`. [Figure 3.21\(c\)](#) shows the actual assembly code generated, while [Figure 3.21\(b\)](#) renders this assembly code in a more readable C representation. Referring to this `goto` code, we see that the loop will be skipped if  $n \leq 1$ , for the initial value of  $n$ . The loop itself has the same general structure as that generated for the do-while version of the function ([Figure 3.19](#)). One interesting feature, however, is that the loop test (line 9 of the assembly code) has been changed from  $n > 1$  in the original C code to  $n \neq 1$ . The compiler has determined that the loop can only be entered when  $n > 1$ , and that decrementing  $n$  will result in either  $n > 1$  or  $n = 1$ . Therefore, the test  $n \neq 1$  will be equivalent to the test  $n \leq 1$ .

## Practice Problem 3.25 (solution page [335](#))

For C code having the general form

```
|
long loop_while2(long a, long b)
{
    long result= _____;
    while(_____) {
        result = _____;
        b= _____;
    }
    return result;
}
```

gcc, run with command-line option `-O1`, produces the following code:

```
|
    a in %rdi, b in %rsi
1  loop_while2:
2  testq  %rsi, %rsi
3  jle   .L8
4  movq  %rsi, %rax
5  .L7:
6  imulq %rdi, %rax
7  subq  %rdi, %rsi
8  testq %rsi, %rsi
```

(a) C code

```
|  
long fact_while (long n)  
{  
    long result = 1;  
    while (n > 1) {  
        result *= n;  
        n = n-1;  
    }  
    return result;  
}
```

(b) Equivalent goto version

```
|  
long fact_while_gd_goto(long n)  
{  
    long result = 1;  
    if (n <= 1)  
        goto done;  
loop:  
    result *= n;  
    n = n-1;  
    if (n != 1)  
        goto loop;  
done:  
    return result;  
}
```

(c) Corresponding assembly-language code

```

|
|
|   long fact_while(long n)
|   n in %rdi
1   fact_while:
2       cmpq  $1, %rdi      Compare n:1
3       jle  .L7           If <=, goto done
4       movl  $1, %eax      Set result = 1
5       .L6:              loop:
6       imulq %rdi, %rax    Compute result *= n
7       subq  $1, %rdi      Decrement n
8       cmpq  $1, %rdi      Compare n:1
9       jne  .L6           If !=, goto loop
10      rep; ret           Return
11      .L7:              done:
12      movl  $1, %eax      Compute result = 1
13      ret               Return

```

**Figure 3.21 C and assembly code for `while` version of factorial using guarded-do translation.**

The `fact_while_gd_goto` function illustrates the operation of the assembly-code version.



```
|
9      jg     .L7
10     rep; ret
11     .L8:
12     movq  %rsi, %rax
13     ret
```

We can see that the compiler used a guarded-do translation, using the `jle` instruction on line 3 to skip over the loop code when the initial test fails. Fill in the missing parts of the C code. Note that the control structure in the assembly code does not exactly match what would be obtained by a direct translation of the C code according to our translation rules. In particular, it has two different `ret` instructions (lines 10 and 13). However, you can fill out the missing portions of the C code in a way that it will have equivalent behavior to the assembly code.

## Practice Problem 3.26 (solution page [336](#))

A function `fun_a` has the following overall structure:

```
|  
long fun_a(unsigned long x) {  
    long val = 0;  
    while (...){  
        :  
    }  
    return ...;  
}
```

The gcc C compiler generates the following assembly code:

```

|
|
| long fun_a(unsigned long x)
| x in %rdi
1  fun_a:
2      movl  $0, %eax
3      jmp   .L5
4      .L6:
5      xorq  %rdi, %rax
6      shrq  %rdi Shift right by 1
7      .L5:
8      testq %rdi, %rdi
9      jne  .L6
10     andl  $1, %eax
11     ret

```


Reverse engineer the operation of this code and then do the following:

- A. Determine what loop translation method was used.
- B. Use the assembly-code version to fill in the missing parts of the C code.
- C. Describe in English what this function computes.

# For Loops

The general form of a `for loop` is as follows:

```
|  
for (init-expr; test-expr; update-expr)  
    body-statement
```

The C language standard states (with one exception, highlighted in [Problem 3.29](#) ) that the behavior of such a loop is identical to the following code using a while loop:

```
|  
init-expr;  
while (test-expr) {  
    body-statement  
    update-expr;  
}
```

The program first evaluates the initialization expression *init-expr*. It enters a loop where it first evaluates the test condition *test-expr*, exiting if the test fails, then executes the body of the loop *body-statement*, and finally evaluates the update expression *update-expr*.

The code generated by gcc for a `for loop` then follows one of our two translation strategies for `while loops`, depending on the optimization level. That is, the jump-to-middle strategy yields the goto code

```
|
|
|   init-expr;  
|   goto test;  
loop:  
|   body-statement  
|   update-expr;  
test:  
|   t = test-expr;  
|   if (t)  
|       goto loop;
```

while the guarded-do strategy yields

```
|  
    init-expr;  
    t = test-expr;  
    if (!t)  
        goto done;  
loop:  
    body-statement  
    update-expr;  
    t = test-expr;  
    if (t)  
        goto loop;  
done:
```

As examples, consider a factorial function written with a `for loop`:

```
|  
long fact_for(long n)  
{  
    long i;  
    long result = 1;  
    for (i = 2; i <= n; i++)  
        result *= i;  
    return result;  
}
```

As shown, the natural way of writing a factorial function with a `for loop` is to multiply factors from 2 up to  $n$ , and so this function is quite different from the code we showed using either a `while` or a `do-while loop`.

We can identify the different components of the `for loop` in this code as follows:

```
|  
init-expr           i=2  
test-expr          i <= n  
update-expr        i++  
body-statement    result *= i;
```

Substituting these components into the template we have shown to transform a `for loop` into a `while loop` yields the following:

```
|  
long fact_for_while(long n)  
{  
    long i = 2;  
    long result = 1;  
    while (i <= n) {  
        result *= i;  
        i++;  
    }  
    return result;  
}
```

Applying the jump-to-middle transformation to the `while loop` then yields the following version in goto code:



```
|  
long fact_for_jm_goto(long n)  
{  
    long i = 2;  
    long result = 1;  
    goto test;  
loop:  
    result *= i;  
    i++;  
test:  
    if (i <= n)  
        goto loop;  
    return result;  
}
```

Indeed, a close examination of the assembly code produced by `gcc` with command-line option `-Og` closely follows this template:

```

|
| long fact_for(long n)
| n in %rdi
fact_for:
| movl $1, %eax      Set result = 1
| movl $2, %edx      Set i = 2
| jmp .L8            Goto test
.L9:          loop:
| imulq %rdx, %rax  Compute result *= i
| addq $1, %rdx     Increment i
.L8:          test:
| cmpq %rdi, %rdx   Compare i:n
| jle .L9           If <=, goto loop
| rep; ret          Return

```

## Practice Problem 3.27 (solution page [336](#))

Write goto code for `fact_for` based on first transforming it to a `while loop` and then applying the guarded-do transformation.

We see from this presentation that all three forms of loops in C—`do-while`, `while`, and `for`—can be translated by a simple strategy, generating code that contains one or more conditional branches. Conditional transfer of control provides the basic mechanism for translating loops into machine code.

## Practice Problem 3.28 (solution page [336](#))

A function `fun_b` has the following overall structure:

```
|  
long fun_b(unsigned long x) {  
    long val = 0;  
    long i;  
    for ( ...; ...; ... ) {  
        :  
    }  
    return val;  
}
```

The `gcc` C compiler generates the following assembly code:

```

|
|
|      long fun_b(unsigned long x)
|      x in %rdi
1     fun_b:
2     movl    $64, %edx
3     movl    $0, %eax
4     .L10:
5     movq    %rdi, %rcx
6     andl    $1, %ecx
7     addq    %rax, %rax
8     orq     %rcx, %rax
9     shrq    %rdi           Shift right by 1
10    subq    $1, %rdx
11    jne     .L10
12    rep; ret

```

Reverse engineer the operation of this code and then do the following:

- A. Use the assembly-code version to fill in the missing parts of the C code.
- B. Explain why there is neither an initial test before the loop nor an initial jump to the test portion of the loop.
- C. Describe in English what this function computes.

## Practice Problem 3.29 (solution page [337](#))


Executing a `continue` statement in C causes the program to jump to the end of the current loop iteration. The stated rule for translating a `for loop` into a `while loop` needs some refinement when dealing with `continue` statements. For example, consider the following code:



```
|  
/* Example of for loop containing a continue statement */  
/* Sum even numbers between 0 and 9 */  
long sum = 0;  
long i;  
for (i = 0; i < 10; i++) {  
    if (i & 1)  
        continue;  
    sum += i;  
}
```

- A. What would we get if we naively applied our rule for translating the `for loop` into a `while loop`? What would be wrong with this code?
- B. How could you replace the `continue` statement with a `goto` statement to ensure that the `while loop` correctly duplicates the behavior of the `for loop`?

## 3.6.8 Switch Statements

A `switch` statement provides a multiway branching capability based on the value of an integer index. They are particularly useful when dealing with tests where there can be a large number of possible outcomes. Not only do they make the C code more readable, but they also allow an efficient implementation using a data structure called *ajump table*. A jump table is an array where entry  $i$  is the address of a code segment implementing the action the program should take when the switch index equals  $i$ . The code performs an array reference into the jump table using the switch index to determine the target for a jump instruction. The advantage of using a jump table over a long sequence of if-else statements is that the time taken to perform the switch is independent of the number of switch cases. Gcc selects the method of translating a `switch` statement based on the number of cases and the sparsity of the case values. Jump tables are used when there are a number of cases (e.g., four or more) and they span a small range of values.

**Figure 3.22(a)**  shows an example of a C `switch` statement. This example has a number of interesting features, including case labels that do not span a contiguous range (there are no labels for cases 101 and 105), cases with multiple labels (cases 104 and 106), and cases that *fall through* to other cases (case 102) because the code for the case does not end with a `break` statement.

**Figure 3.23**  shows the assembly code generated when compiling `switch_eg`. The behavior of this code is shown in C as the procedure `switch_eg_impl` in **Figure 3.22(b)** . This code makes use of support provided by `gcc` for jump tables, as an extension to the C language. The array `jt` contains seven entries, each of which is the address of a block of code. These locations are defined by labels in the code and indicated in the entries in `jt` by code pointers, consisting of the labels prefixed by `&&`. (Recall that the operator `'&'` creates a pointer for a data value. In making this extension, the authors of `Gcc` created a new operator `&&` to create a pointer for a code location.) We recommend that you study the C procedure `switch_eg_impl` and how it relates to the assembly-code version.

Our original C code has cases for values 100, 102–104, and 106, but the switch variable `n` can be an arbitrary integer. The compiler first shifts the range to between 0 and 6 by subtracting 100 from `n`, creating a new program variable that we call `index` in our C version. It further simplifies the branching possibilities by treating `index` as an *unsigned* value, making use of the fact that negative numbers in a two's-complement representation map to large positive numbers in an unsigned representation. It can therefore test whether `index` is outside of the range 0–6 by testing whether it is greater than 6. In the C and assembly code, there are five distinct locations to jump to, based on the value of `index`. These are `loc_A` (identified in the assembly code as `.L3`), `loc_B` (`.L5`), `loc_C` (`.L6`), `loc_D` (`.L7`), and `loc_def` (`.L8`), where the latter is the destination for the default case.

Each of these labels identifies a block of code implementing one of the case branches. In both the C and the assembly code, the program compares index to 6 and jumps to the code for the default case if it is greater.

The key step in executing a `switch` statement is to access a code location through the jump table. This occurs in line 16 in the C code, with a `goto` statement that references the jump table `jt`. This *computed goto* is supported by `gcc` as an extension to the C language. In our assembly-code version, a similar operation occurs on line 5, where the `jmp` instruction's operand is prefixed with ``*`, indicating



(a) Switch statement

```
|  
void switch_eg(long x, long n, long *dest)  
{  
    long val = x;  
  
    switch (n) {  
  
        case 100:  
            val *= 13;  
            break;  
  
        case 102:  
            val += 10;  
            /* Fall through */  
  
        case 103:  
            val += 11;  
            break;  
  
        case 104:  
        case 106:  
            val *= val;  
            break;  
  
        default:  
            val = 0;  
    }  
}
```

```
*dest = val;
```

```
}
```

(b) Translation into extended C

```

1      void switch_eg_impl(long x, long n,
2                                     long *dest)
3      {
4          /* Table of code pointers */
5          static void *jt[7] = {
6              &&loc_A, &&loc_def, &&loc_B,
7              &&loc_C, &&loc_D, &&loc_def,
8              &&loc_D
9          };
10         unsigned long index = n - 100;
11         long val;
12
13         if (index > 6)
14             goto loc_def;
15         /* Multiway branch */
16         goto *jt[index];
17
18     loc_A: /* Case 100 */
19         val = x * 13;
20         goto done;
21     loc_B: /* Case 102 */
22         x = x + 10;
23         /* Fall through */
24     loc_C: /* Case 103 */
25         val = x + 11;
26         goto done;
27     loc_D: /* Cases 104, 106 */

```

```
28         val = x * x;
29         goto done;
30     loc_def: /* Default case */
31         val = 0;
32     done:
33         *dest = val;
34 }
```

**Figure 3.22** Example `switch` statement and its translation into extended C.

The translation shows the structure of `jump` table `jt` and how it is accessed. Such tables are supported by `gcc` as an extension to the C language.

an indirect jump, and the operand specifies a memory location indexed by register `%eax`, which holds the value of `index`. (We will see in [Section 3.8](#) how array references are translated into machine code.)

Our C code declares the jump table as an array of seven elements, each of which is a pointer to a code location. These elements span values 0–6 of

```

|
|
|     void switch_eg(long x, long n, long *dest)
|     x in %rdi, n in %rsi, dest in %rdx
1     switch_eg:
2         subq $100, %rsi           Compute index = n-100
3         cmpq $6, %rsi            Compare index:6
4         ja .L8                   If >, goto loc_def
5         jmp *.L4 (,%rsi,8)        Goto *jg[index]
6     .L3:                          loc_A:
7         leaq (%rdi,%rdi,2), %rax  3*x
8         leaq (%rdi,%rax,4), %rdi  val = 13*x
9         jmp .L2                   Goto done
10    .L5:                          loc_B:
11        addq $10, %rdi            x = x + 10
12    .L6:                          loc_C:
13        addq $11, %rdi           val = x + 11
14        jmp .L2                   Goto done
15    .L7:                          loc_D:
16        imulq %rdi, %rdi         val = x * x
17        jmp .L2                   Goto done
18    .L8:                          loc_def:
19        movl $0, %edi            val = 0
20    .L2:                          done:
21        movq %rdi, (%rdx)        *dest = val
22        ret                       Return

```

**Figure 3.23** Assembly code for `switch` statement example in [Figure 3.22](#).

`index`, corresponding to values 100–106 of `n`. Observe that the jump table handles duplicate cases by simply having the same code label (`loc_D`) for entries 4 and 6, and it handles missing cases by using the label for the default case (`loc_def`) as entries 1 and 5.

In the assembly code, the jump table is indicated by the following declarations, to which we have added comments:

```
1      .section      .rodata
2      .align 8      Align address to multiple of 8
3      .L4:
4      .quad .L3      Case 100: loc_A
5      .quad .L8      Case 101: loc_def
6      .quad .L5      Case 102: loc_B
7      .quad .L6      Case 103: loc_C
8      .quad .L7      Case 104: loc_D
9      .quad .L8      Case 105: loc_def
10     .quad .L7      Case 106: loc_D
```

These declarations state that within the segment of the object-code file called `.rodata` (for "read-only data"), there should be a sequence of seven "quad" (8-byte) words, where the value of each word is given by the instruction address associated with the indicated

assembly-code labels (e.g., `.L3`). Label `.L4` marks the start of this allocation. The address associated with this label serves as the base for the indirect jump (line 5).

The different code blocks (C labels `loc_A` through `loc_D` and `loc_def`) implement the different branches of the `switch` statement. Most of them simply compute a value for `val` and then go to the end of the function. Similarly, the assembly-code blocks compute a value for register `%rdi` and jump to the position indicated by label `.L2` at the end of the function. Only the code for case label 102 does not follow this pattern, to account for the way the code for this case falls through to the block with label 103 in the original C code. This is handled in the assembly-code block starting with label `.L5`, by omitting the `jmp` instruction at the end of the block, so that the code continues execution of the next block. Similarly, the C version `switch_eg_impl` has no `goto` statement at the end of the block starting with label `loc_B`.

Examining all of this code requires careful study, but the key point is to see that the use of a jump table allows a very efficient way to implement a multiway branch. In our case, the program could branch to five distinct locations with a single jump table reference. Even if we had a `switch` statement with hundreds of cases, they could be handled by a single jump table access.



## Practice Problem 3.30 (solution page 338)

In the C function that follows, we have omitted the body of the `switch` statement. In the C code, the case labels did not span a contiguous range, and some cases had multiple labels.

```
|  
void switch2 (long x, long *dest) {  
    long val = 0;  
    switch (x) {  
        : Body of switch statement omitted  
    }  
    *dest = val;  
}
```

In compiling the function, gcc generates the assembly code that follows for the initial part of the procedure, with variable `x` in `%rdi`:

```

|
void switch2(long x, long *dest)
    x in %rdi
1    switch2:
2        addq    $1, %rdi
3        cmpq    $8, %rdi
4        ja     .L2
5        jmp     *.L4(,%rdi,8)

```

It generates the following code for the jump table:

```

|
1    .L4:
2    .quad    .L9
3    .quad    .L5
4    .quad    .L6
5    .quad    .L7
6    .quad    .L2
7    .quad    .L7
8    .quad    .L8
9    .quad    .L2
10   .quad    .L5

```

Based on this information, answer the following questions:

- A. What were the values of the case labels in the `switch` statement?
- B. What cases had multiple labels in the C code?

*Practice Problem 3.31 (solution page*  
**338)**

For a C function `switcher` with the general structure

```

|
void switcher(long a, long b, long c, long *dest)
{
    long val;
    switch(a) {
        case _____: /* CaseA*/
            c= _____;
            /* Fall through */
        case _____: /* Case B */
            val= _____;
            break;
        case _____: /* Case C */
        case _____: /* Case D */
            val = _____;
            break;
        case _____: /* Case E */
            val = _____;
            break;
        default:
            val = _____;
    }
    *dest = val;
}

```

gcc generates the assembly code and jump table shown in [Figure 3.24](#).

Fill in the missing parts of the C code. Except for the ordering of case labels `C` and `D`, there is only one way to fit the different cases into the template.

(a) Code

```
|
|
| void switcher(long a, long b, long c, long *dest)
| a in %rsi, b in %rdi, c in %rdx, d in %rcx
1 switcher:
2     cmpq $7, %rdi
3     ja .L2
4     jmp *.L4(,%rdi,8)
5     .section .rodata
6     .L7:
7     xorq $15, %rsi
8     movq %rsi, %rdx
9     .L3:
10    leaq 112(%rdx), %rdi
11    jmp .L6
12    .L5:
13    leaq (%rdx,%rsi), %rdi
14    salq $2, %rdi
15    jmp .L6
16    .L2:
17    movq %rsi, %rdi
18    .L6:
19    movq %rdi, (%rcx)
20    ret
```

(b) Jump table

```
|
1 .L4:
2 .quad .L3
3 .quad .L2
4 .quad .L5
5 .quad .L2
6 .quad .L6
7 .quad .L7
8 .quad .L2
9 .quad .L5
```

Figure 3.24 Assembly code and jump table for [Problem 3.31](#) .

## 3.7 Procedures

Procedures are a key abstraction in software. They provide a way to package code that implements some functionality with a designated set of arguments and an optional return value. This function can then be invoked from different points in a program. Well-designed software uses procedures as an abstraction mechanism, hiding the detailed implementation of some action while providing a clear and concise interface definition of what values will be computed and what effects the procedure will have on the program state. Procedures come in many guises in different programming languages—functions, methods, subroutines, handlers, and so on—but they all share a general set of features.

There are many different attributes that must be handled when providing machine-level support for procedures. For discussion purposes, suppose procedure **P** calls procedure **Q**, and **Q** then executes and returns back to **P**. These actions involve one or more of the following mechanisms:

**Passing control.** The program counter must be set to the starting address of the code for **Q** upon entry and then set to the instruction in **P** following the call to **Q** upon return.

**Passing data.** **P** must be able to provide one or more parameters to **Q**, and **Q** must be able to return a value back to **P**.



**Allocating and deallocating memory.** `q` may need to allocate space for local variables when it begins and then free that storage before it returns.

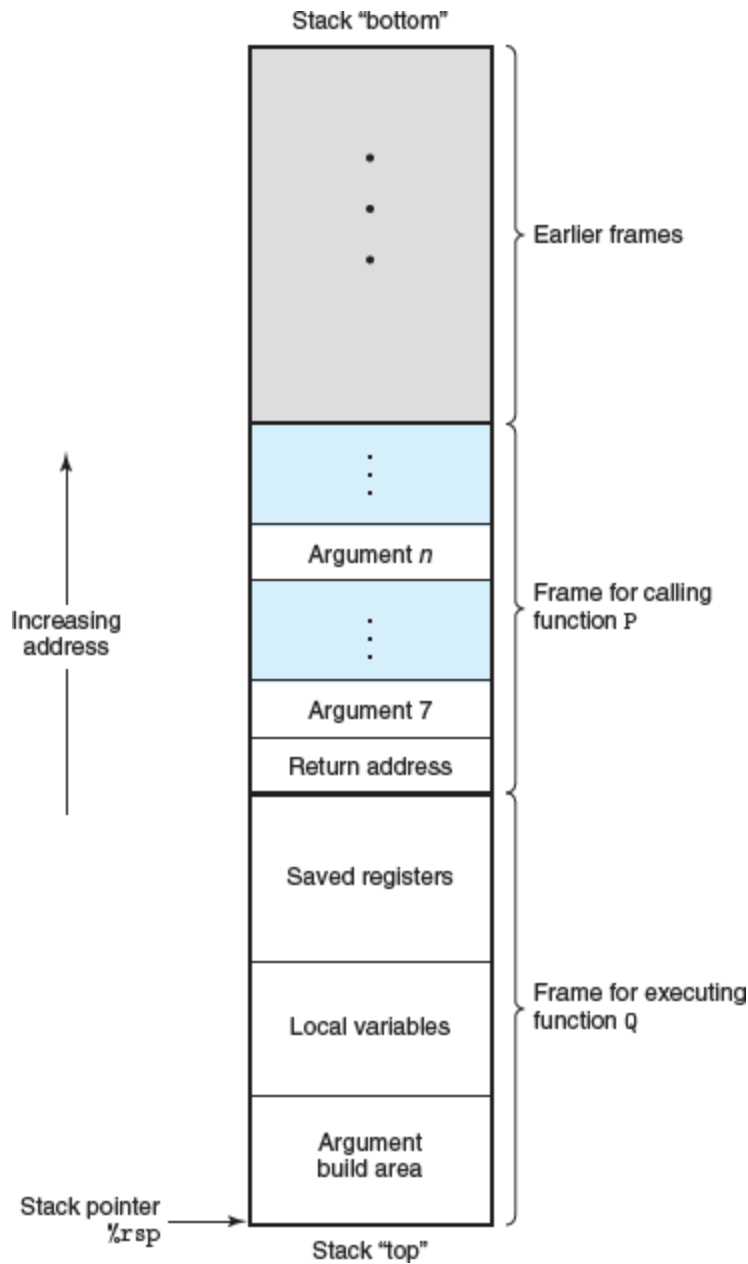
The x86-64 implementation of procedures involves a combination of special instructions and a set of conventions on how to use the machine resources, such as the registers and the program memory. Great effort has been made to minimize the overhead involved in invoking a procedure. As a consequence, it follows what can be seen as a minimalist strategy, implementing only as much of the above set of mechanisms as is required for each particular procedure. In our presentation, we build up the different mechanisms step by step, first describing control, then data passing, and, finally, memory management.

## 3.7.1 The Run-Time Stack

A key feature of the procedure-calling mechanism of C, and of most other languages, is that it can make use of the last-in, first-out memory management discipline provided by a stack data structure. Using our example of procedure `P` calling procedure `Q`, we can see that while `Q` is executing, `P`, along with any of the procedures in the chain of calls up to `P`, is temporarily suspended. While `Q` is running, only it will need the ability to allocate new storage for its local variables or to set up a call to another procedure. On the other hand, when `Q` returns, any local storage it has allocated can be freed. Therefore, a program can manage the storage required by its procedures using a stack, where the stack and the program registers store the information required for passing control and data, and for allocating memory. As `P` calls `Q`, control and data information are added to the end of the stack. This information gets deallocated when `P` returns.

As described in [Section 3.4.4](#), the x86-64 stack grows toward lower addresses and the stack pointer `%rsp` points to the top element of the stack. Data can be stored on and retrieved from the stack using the `pushq` and `popq` instructions. Space for data with no specified initial value can be allocated on the stack by simply decrementing the stack pointer by an appropriate amount. Similarly, space can be deallocated by incrementing the stack pointer.

When an x86-64 procedure requires storage beyond what it can hold in registers, it allocates space on the stack. This region is referred to as the procedure's



**Figure 3.25 General stack frame structure.**

The stack can be used for passing arguments, for storing return information, for saving registers, and for local storage. Portions may be omitted when not needed.

*stack frame*. [Figure 3.25](#) shows the overall structure of the run-time stack, including its partitioning into stack frames, in its most

general form. The frame for the currently executing procedure is always at the top of the stack. When procedure **P** calls procedure **Q**, it will push the *return address* onto the stack, indicating where within **P** the program should resume execution once **Q** returns. We consider the return address to be part of **P**'s stack frame, since it holds state relevant to **P**. The code for **Q** allocates the space required for its stack frame by extending the current stack boundary. Within that space, it can save the values of registers, allocate space for local variables, and set up arguments for the procedures it calls. The stack frames for most procedures are of fixed size, allocated at the beginning of the procedure. Some procedures, however, require variable-size frames. This issue is discussed in [Section 3.10.5](#). Procedure **P** can pass up to six integral values (i.e., pointers and integers) on the stack, but if **Q** requires more arguments, these can be stored by **P** within its stack frame prior to the call.

In the interest of space and time efficiency, x86-64 procedures allocate only the portions of stack frames they require. For example, many procedures have six or fewer arguments, and so all of their parameters can be passed in registers. Thus, parts of the stack frame diagrammed in [Figure 3.25](#) may be omitted. Indeed, many functions do not even require a stack frame. This occurs when all of the local variables can be held in registers and the function does not call any other functions (sometimes referred to as a *leaf procedure*, in reference to the tree structure of procedure calls). For example, none of the functions we have examined thus far required stack frames.

## 3.7.2 Control Transfer

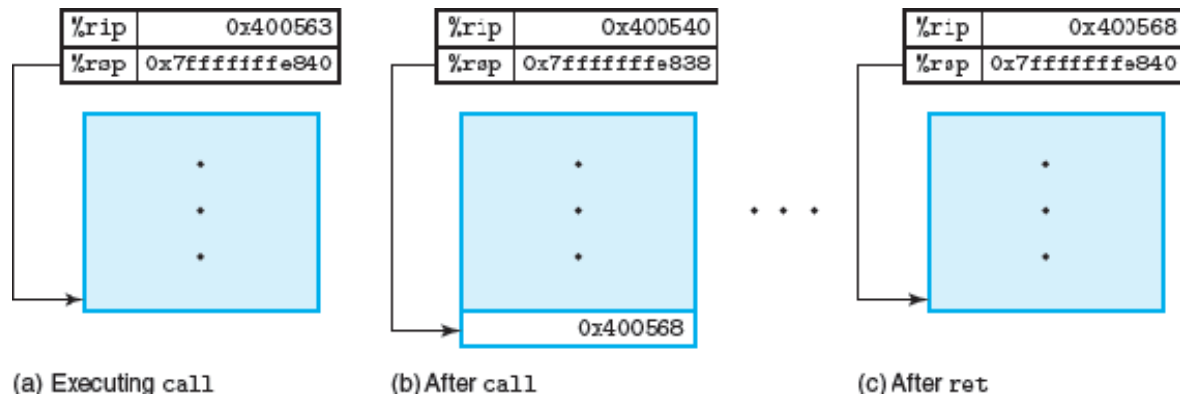
Passing control from function `P` to function `Q` involves simply setting the program counter (PC) to the starting address of the code for `Q`. However, when it later comes time for `Q` to return, the processor must have some record of the code location where it should resume the execution of `P`. This information is recorded in x86-64 machines by invoking procedure `Q` with the instruction `call Q`. This instruction pushes an address `A` onto the stack and sets the PC to the beginning of `Q`. The pushed address `A` is referred to as the *return address* and is computed as the address of the instruction immediately following the `call` instruction. The counterpart instruction `ret` pops an address `A` off the stack and sets the PC to `A`.

The general forms of the `call` and `ret` instructions are described as follows:

(These instructions are referred to as `callq` and `retq` in the disassembly outputs generated by the program `OBJDUMP`. The added suffix ``q'` simply emphasizes that these are x86-64 versions of call and return instructions, not IA32. In x86-64 assembly code, both versions can be used interchangeably.)

The `call` instruction has a target indicating the address of the instruction where the called procedure starts. Like jumps, a call can be either direct or indirect. In assembly code, the target of a direct

call is given as a label, while the target of an indirect call is given by ``*'` followed by an operand specifier using one of the formats described in [Figure 3.3](#).



**Figure 3.26** Illustration of `call` and `ret` functions.

The `call instruction` transfers control to the start of a function, while the `ret` instruction returns back to the instruction following the call.

[Figure 3.26](#) illustrates the execution of the `call` and `ret` instructions for the `multstore` and `main` functions introduced in [Section 3.2.2](#). The following are excerpts of the disassembled code for the two functions:

```

|
|
| Beginning of function multstore
1 000000000000400540 <multstore>:
2 400540: 53                push   %rbx
3 400541: 48 89 d3          mov    %rdx,%rbx
|
| ...
| Return from function multstore
4 40054d: c3                retq
|
| ...
| Call to multstore from main
5 400563: e8 d8 ff ff ff   callq 400540 <multstore>
6 400568: 48 8b 54 24 08   mov   0x8(%rsp),%rdx

```

In this code, we can see that the `call` instruction with address `0x400563` in `main` calls function `multstore`. This status is shown in **Figure 3.26(a)**, with the indicated values for the stack pointer `%rsp` and the program counter `%rip`. The effect of the `call` is to push the return address `0x400568` onto the stack and to jump to the first instruction in function `multstore`, at address `0x0400540` (3.26(b)). The execution of `function` `multstore` continues until it hits the `ret` instruction at address `0x40054d`. This instruction pops the value `0x400568` from the stack and jumps to this address, resuming the execution of `main` just after the `call` instruction (3.26(c)).

As a more detailed example of passing control to and from procedures, **Figure 3.27(a)** shows the disassembled code for two



functions, `top` and `leaf`, as well as the portion of code in function `main` where `top` gets called. Each instruction is identified by labels `L1-L2` (in `leaf`), `T1-T4` (in `top`), and `M1-M2` in `main`. Part (b) of the figure shows a detailed trace of the code execution, in which `main` calls `top(100)`, causing `top` to call `leaf(95)`. Function `leaf` returns 97 to `top`, which

(a) Disassembled code for demonstrating procedure calls and returns

```
|
|
| Disassembly of leaf(long y)
| y in %rdi
1 00000000000400540 <leaf>:
2 400540: 48 8d 47 02    lea    0x2(%rdi),%rax  L1: z+2
3 400544: c3            retq                               L2:
| Return
|
4 00000000000400545 <top>:
| Disassembly of top(long x)
| x in %rdi
5 400545: 48 83 ef 05    sub    $0x5,%rdi      T1: x-5
6 400549: e8 f2 ff ff ff callq  400540 <leaf>   T2: Call
| leaf(x-5)
7 40054e: 48 01 c0      add    %rax,%rax      T3:
| Double result
8 400551: c3            retq                               T4:
| Return
| ...
| Call to top from function main
9 40055b: e8 e5 ff ff ff callq  400545 <top>   M1: Call
| top(100)
10 400560: 48 89 c2     mov    %rax,%rdx     M2:
| Resume
```

(b) Execution trace of example code

**Figure 3.27 Detailed execution of program involving procedure calls and returns.**

Using the stack to store return addresses makes it possible to return to the right point in the procedures.

then returns 194 to `main`. The first three columns describe the instruction being executed, including the instruction label, the address, and the instruction type. The next four columns show the state of the program *before* the instruction is executed, including the contents of registers `%rdi`, `%rax`, and `%rsp`, as well as the value at the top of the stack. The contents of this table should be studied carefully, as they demonstrate the important role of the run-time stack in managing the storage needed to support procedure calls and returns.

Instruction `L1` of `leaf` sets `%rax` to 97, the value to be returned. Instruction `L2` then returns. It pops `0x400054e` from the stack. In setting the PC to this popped value, control transfers back to instruction `T3` of `top`. The program has successfully completed the call to `leaf` and returned to `top`.

Instruction `T3` sets `%rax` to 194, the value to be returned from `top`. Instruction `T4` then returns. It pops `0x4000560` from the stack, thereby setting the PC to instruction `M2` of `main`. The program has

successfully completed the call to `top` and returned to `main`. We see that the stack pointer has also been restored to `0x7fffffff820`, the value it had before the call to `top`.

We can see that this simple mechanism of pushing the return address onto the stack makes it possible for the function to later return to the proper point in the program. The standard call/return mechanism of C (and of most programming languages) conveniently matches the last-in, first-out memory management discipline provided by a stack.

## *Practice Problem 3.32 (solution page 339)*

The disassembled code for two functions `first` and `last` is shown below, along with the code for a call of `first` by function `main`:

*Disassembly of last(long u, long v)*

*u in %rdi, v in %rsi*

1 0000000000400540 <last>:

2 400540: 48 89 f8 mov

%rdi,%rax *L1: u*

3 400543: 48 0f af c6 imul

%rsi,%rax *L2: u\*v*

4 400547: c3 retq

*L3: Return*

*Disassembly of last(long x)*

*x in %rdi*

5 0000000000400548 <first>:

6 400548: 48 8d 77 01 lea

0x1(%rdi),%rsi *F1: x+1*

7 40054c: 48 83 ef 01 sub

\$0x1,%rdi *F2: x-1*

8 400550: e8 eb ff ff ff callq

400540 <last> *F3: Call last(x-1,x+1)*

9 400555: f3 c3 repz retq

*F4: Return*


:

10 400560: e8 e3 ff ff ff callq

400548 <first> *M1: Call first(10)*

11 400565: 48 89 c2 mov

%rax,%rdx *M2: Resume*

Each of these instructions is given a label, similar to those in **Figure 3.27(a)** . Starting with the calling of `first(10)` by `main`, fill in the following table to trace instruction execution through to the point where the program returns back to `main`.

## 3.7.3 Data Transfer

In addition to passing control to a procedure when called, and then back again when the procedure returns, procedure calls may involve passing data as arguments, and returning from a procedure may also involve returning a value. With x86-64, most of these data passing to and from procedures take place via registers. For example, we have already seen numerous examples of functions where arguments are passed in registers `%rdi`, `%rsi`, and others, and where values are returned in register `%rax`. When procedure `P` calls procedure `Q`, the code for `P` must first copy the arguments into the proper registers. Similarly, when `Q` returns back to `P`, the code for `P` can access the returned value in register `%rax`. In this section, we explore these conventions in greater detail.

With x86-64, up to six integral (i.e., integer and pointer) arguments can be passed via registers. The registers are used in a specified order, with the name used for a register depending on the size of the data type being passed. These are shown in [Figure 3.28](#). Arguments are allocated to these registers according to their



### Figure 3.28 Registers for passing function arguments.

The registers are used in a specified order and named according to the argument sizes.

ordering in the argument list. Arguments smaller than 64 bits can be accessed using the appropriate subsection of the 64-bit register. For example, if the first argument is 32 bits, it can be accessed as `%edi`.

When a function has more than six integral arguments, the other ones are passed on the stack. Assume that procedure `P` calls procedure `Q` with  $n$  integral arguments, such that  $n > 6$ . Then the code for `P` must allocate a stack frame with enough storage for arguments 7 through  $n$ , as illustrated in [Figure 3.25](#). It copies arguments 1–6 into the appropriate registers, and it puts arguments 7 through  $n$  onto the stack, with argument 7 at the top of the stack. When passing parameters on the stack, all data sizes are rounded up to be multiples of eight. With the arguments in place, the program can then execute a `call` instruction to transfer control to procedure `Q`. Procedure `Q` can access its arguments via registers and possibly from the stack. If `Q`, in turn, calls some function that has more than six arguments, it can allocate space within its stack frame for these, as is illustrated by the area labeled "Argument build area" in [Figure 3.25](#).

As an example of argument passing, consider the C function `proc` shown in [Figure 3.29\(a\)](#). This function has eight arguments,

including integers with different numbers of bytes (8, 4, 2, and 1), as well as different types of pointers, each of which is 8 bytes.

The assembly code generated for `proc` is shown in **Figure 3.29(b)**. The first six arguments are passed in registers. The last two are passed on the stack, as documented by the diagram of **Figure 3.30**. This diagram shows the state of the stack during the execution of `proc`. We can see that the return address was pushed onto the stack as part of the procedure call. The two arguments, therefore, are at positions 8 and 16 relative to the stack pointer. Within the code, we can see that different versions of the `ADD` instruction are used according to the sizes of the operands: `addq` for `a1 (long)`, `addl` for `a2 (int)`, `addw` for `a3 (short)`, and `addb` for `a4 (char)`. Observe that the `movl` instruction of line 6 reads 4 bytes from memory; the following `addb` instruction only makes use of the low-order byte.

## Practice Problem 3.33 (solution page 339)

A C function `procprob` has four arguments `u`, `a`, `v`, and `b`. Each is either a signed number or a pointer to a signed number, where the numbers have different sizes. The function has the following body:

```
|  
*u += a;  
*v += b;  
return sizeof(a) + sizeof(b);
```

It compiles to the following x86-64 code:

```
|  
1 procprob:  
2 movslq %edi, %rdi  
3 addq %rdi, (%rdx)  
4 addb %sil, (%rcx)
```

(a) C code

```
|  
void proc(long a1, long *a1p,  
          int a2, int *a2p,  
          short a3, short *a3p,  
          char a4, char *a4p)  
{  
    *a1p += a1;  
    *a2p += a2;  
    *a3p += a3;  
    *a4p += a4;  
}
```

(b) Generated assembly code

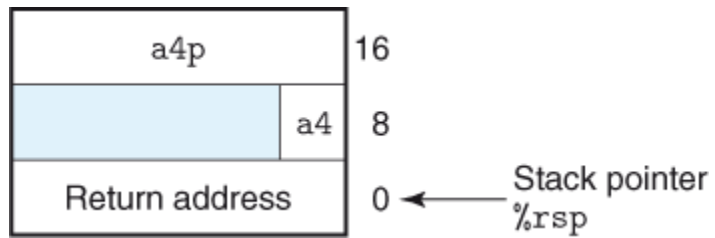
```

|
|
|   void proc(a1, a1p, a2, a2p, a3, a3p, a4, a4p)
|   Arguments passed as follows:
|   a1 in %rdi (64 bits)
|   a1p in %rsi (64 bits)
|   a2 in %edx (32 bits)
|   a2p in %rcx (64 bits)
|   a3 in %r8w (16 bits)
|   a3p in %r9 (64 bits)
|   a4 at %rsp+8 ( 8 bits)
|   a4p at %rsp+16 (64 bits)
1   proc:
2   movq   16(%rsp), %rax   Fetch a4p (64 bits)
3   addq   %rdi, (%rsi)    *a1p += a1 (64 bits)
4   addl   %edx, (%rcx)    *a2p += a2 (32 bits)
5   addw   %r8w, (%r9)     *a3p += a3 (16 bits)
6   movl   8(%rsp), %edx   Fetch a4 (8 bits)
7   addb   %dl, (%rax)     *a4p += a4 (8 bits)
8   ret                               Return

```

**Figure 3.29 Example of function with multiple arguments of different types.**

Arguments 1–6 are passed in registers, while arguments 7–8 are passed on the stack.



**Figure 3.30 Stack frame structure for function `proc`.** Arguments `a4` and `a4p` are passed on the stack.

```

5 movl $6, %eax
6 ret


```



Determine a valid ordering and types of the four parameters. There are two correct answers.

## 3.7.4 Local Storage on the Stack

Most of the procedure examples we have seen so far did not require any local storage beyond what could be held in registers. At times, however, local data must be stored in memory. Common cases of this include these:

- There are not enough registers to hold all of the local data.
- The address operator `&` is applied to a local variable, and hence we must be able to generate an address for it.
- Some of the local variables are arrays or structures and hence must be accessed by array or structure references. We will discuss this possibility when we describe how arrays and structures are allocated.

Typically, a procedure allocates space on the stack frame by decrementing the stack pointer. This results in the portion of the stack frame labeled "Local variables" in [Figure 3.25](#) .

As an example of the handling of the address operator, consider the two functions shown in [Figure 3.31\(a\)](#) . The function `swap_add` swaps the two values designated by pointers `xp` and `yp` and also returns the sum of the two values. The function `caller` creates pointers to local variables `arg1` and `arg2` and passes these to `swap_add`. [Figure 3.31\(b\)](#)  shows how `caller` uses a stack frame to implement these local variables. The code for `caller` starts by

decrementing the stack pointer by 16; this effectively allocates 16 bytes on the stack. Letting  $S$  denote the value of the stack pointer, we can see that the code computes `&arg2` as  $S + 8$  (line 5), `&arg1` as  $S$  (line 6). We can therefore infer that local variables `arg1` and `arg2` are stored within the stack frame at offsets 0 and 8 relative to the stack pointer. When the call to `swap_add` completes, the code for `caller` then retrieves the two values from the stack (lines 8–9), computes their difference, and multiplies this by the value returned by `swap_add` in register `%rax` (line 10). Finally, the function deallocates its stack frame by incrementing the stack pointer by 16 (line 11.) We can see with this example that the run-time stack provides a simple mechanism for allocating local storage when it is required and deallocating it when the function completes.

As a more complex example, the function `call_proc`, shown in [Figure 3.32](#), illustrates many aspects of the x86-64 stack discipline. Despite the length of this example, it is worth studying carefully. It shows a function that must allocate storage on the stack for local variables, as well as to pass values to the 8-argument function `proc` ([Figure 3.29](#)). The function creates a stack frame, diagrammed in [Figure 3.33](#).

Looking at the assembly code for `call_proc` ([Figure 3.32\(b\)](#)), we can see that a large portion of the code (lines 2–15) involves preparing to call function



(a) Code for swap\_add and calling function

```
|  
long swap_add(long *xp, long *yp)  
{  
    long x = *xp;  
    long y = *yp;  
    *xp = y;  
    *yp = x;  
    return x + y;  
}  
long caller()  
{  
    long arg1 = 534;  
    long arg2 = 1057;  
    long sum = swap_add(&arg1, &arg2);  
    long diff = arg1 - arg2;  
    return sum * diff;  
}
```

(b) Generated assembly code for calling function

```

|
|
|   long caller()
1   caller:
2   subq   $16, %rsp   Allocate 16 bytes for stack
   frame
3   movq   $534, (%rsp)   Store 534 in arg1
4   movq   $1057, 8(%rsp)   Store 1057 in arg2
5   leaq   8(%rsp), %rsi   Compute &arg2 as second argument
6   movq   %rsp, %rdi   Compute &arg1 as first argument
7   call   swap_add   Call swap_add(&arg1, &arg2)
8   movq   (%rsp), %rdx   Get arg1
9   subq   8(%rsp), %rdx   Compute diff = arg1 - arg2
10  imulq  %rdx, %rax   Compute sum * diff
11  addq   $16, %rsp   Deallocate stack frame
12  ret   Return

```

### Figure 3.31 Example of procedure definition and call.

The calling code must allocate a stack frame due to the presence of address operators.

`proc`. This includes setting up the stack frame for the local variables and function parameters, and for loading function arguments into registers. As [Figure 3.33](#) shows, local variables `x1-x4` are allocated on the stack and have different sizes. Expressing their locations as offsets relative to the stack pointer, they occupy bytes 24–31 (`x1`), 20–23 (`x2`), 18–19 (`x3`), and 17 (`s3`). Pointers to these locations are generated by `leaq` instructions (lines 7, 10, 12, and

14). Arguments 7 (with value 4) and 8 (a pointer to the location of `x4`) are stored on the stack at offsets 0 and 8 relative to the stack pointer.

(a) C code for calling function

```
|  
long call_proc()  
{  
    long x1 = 1; int x2 = 2;  
    short x3 = 3; char x4 = 4;  
    proc(x1, &x1, x2, &x2, x3, &x3, x4, &x4);  
    return (x1+x2)*(x3-x4);  
}
```

(b) Generated assembly code

```

|
|
| long call_proc()
1  call_proc:
|   Set up arguments to proc
2  subq    $32, %rsp           Allocate 32-byte stack
| frame
3  movq    $1, 24(%rsp)       Store 1 in &x1
4  movl    $2, 20(%rsp)       Store 2 in &x2
5  movw    $3, 18(%rsp)       Store 3 in &x3
6  movb    $4, 17(%rsp)       Store 4 in &x4
7  leaq    17(%rsp), %rax     Create &x4
8  movq    %rax, 8(%rsp)      Store &x4 as argument 8
9  movl    $4, (%rsp)         Store 4 as argument 7
10 leaq    18(%rsp), %r9      Pass &x3 as argument 6
11 movl    $3, %r8d           Pass 3 as argument 5
12 leaq    20(%rsp), %rcx     Pass &x2 as argument 4
13 movl    $2, %edx           Pass 2 as argument 3
14 leaq    24(%rsp), %rsi     Pass &x1 as argument 2
15 movl    $1, %edi           Pass 1 as argument 1
|   Call proc
16 call proc
|   Retrieve changes to memory
17 movslq  20(%rsp), %rdx     Get x2 and convert to
| long
18 addq    24(%rsp), %rdx     Compute x1+x2
19 movswl  18(%rsp), %eax     Get x3 and convert to
| int
20 movsbl  17(%rsp), %ecx     Get x4 and convert to

```

```

int
21    subl    %ecx, %eax           Compute x3-x4
22    cltq
23    imulq  %rdx, %rax          Compute (x1+x2) * (x3-
x4)
24    addq   $32, %rsp           Deallocate stack frame
25    ret
Return

```

Figure 3.32 Example of code to call function `proc`, defined in Figure 3.29.

This code creates a stack frame.

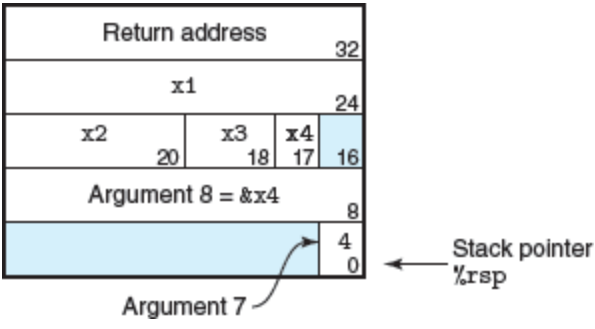


Figure 3.33 Stack frame for function `call_proc`.

The stack frame contains local variables, as well as two of the arguments to pass to function `proc`.

When procedure `proc` is called, the program will begin executing the code shown in Figure 3.29(b). As shown in Figure 3.30, arguments 7 and 8 are now at offsets 8 and 16 relative to the stack pointer, because the return address was pushed onto the stack.

When the program returns to `call_proc`, the code retrieves the values of the four local variables (lines 17–20) and performs the final computations. It finishes by incrementing the stack pointer by 32 to deallocate the stack frame.

## 3.7.5 Local Storage in Registers

The set of program registers acts as a single resource shared by all of the procedures. Although only one procedure can be active at a given time, we must make sure that when one procedure (the *caller*) calls another (the *callee*), the callee does not overwrite some register value that the caller planned to use later. For this reason, x86-64 adopts a uniform set of conventions for register usage that must be respected by all procedures, including those in program libraries.

By convention, registers `%rbx`, `%rbp`, and `%r12-%r15` are classified as *callee-saved* registers. When procedure `P` calls procedure `Q`, `Q` must *preserve* the values of these registers, ensuring that they have the same values when `Q` returns to `P` as they did when `Q` was called. Procedure `Q` can preserve a register value by either not changing it at all or by pushing the original value on the stack, altering it, and then popping the old value from the stack before returning. The pushing of register values has the effect of creating the portion of the stack frame labeled "Saved registers" in [Figure 3.25](#). With this convention, the code for `P` can safely store a value in a callee-saved register (after saving the previous value on the stack, of course), call `Q`, and then use the value in the register without risk of it having been corrupted.

All other registers, except for the stack pointer `%rsp`, are classified as *caller-saved* registers. This means that they can be modified by any



function. The name "caller saved" can be understood in the context of a procedure **P** having some local data in such a register and calling procedure **Q**. Since **Q** is free to alter this register, it is incumbent upon **P** (the caller) to first save the data before it makes the call.

As an example, consider the function **P** shown in [Figure 3.34\(a\)](#). It calls **Q** twice. During the first call, it must retain the value of **x** for use later. Similarly, during the second call, it must retain the value computed for  $Q(y)$ . In [Figure 3.34\(b\)](#),

(a) Calling function

```
|  
long P(long x, long y)  
{  
    long u = Q(y);  
    long v = Q(x);  
    return u + v;  
}
```

(b) Generated assembly code for the calling function

```

|
|
|   long P(long x, long y)
|   x in %rdi, y in %rsi
1   P:
2   pushq  %rbp          Save %rbp
3   pushq  %rbx          Save %rbx
4   subq   $8, %rsp      Align stack frame
5   movq   %rdi, %rbp    Save x
6   movq   %rsi, %rdi    Move y to first argument
7   call   Q             Call Q(y)
8   movq   %rax, %rbx    Save result
9   movq   %rbp, %rdi    Move x to first argument
10  call   Q             Call Q(x)
11  addq   %rbx, %rax     Add saved Q(y) to Q(x)
12  addq   $8, %rsp      Deallocate last part of stack
13  popq   %rbx          Restore %rbx
14  popq   %rbp          Restore %rbp
15  ret

```

**Figure 3.34 Code demonstrating use of callee-saved registers.** Value `x` must be preserved during the first call, and value `Q(y)` must be preserved during the second.

we can see that the code generated by `gcc` uses two callee-saved registers: `%rbp` to hold `x`, and `%rbx` to hold the computed value of `Q(y)`. At the beginning of the function, it saves the values of these two registers on the stack (lines 2–3). It copies argument `x` to `%rbp`

before the first call to `q` (line 5). It copies the result of this call to `%rbx` before the second call to `q` (line 8). At the end of the function (lines 13–14), it restores the values of the two callee-saved registers by popping them off the stack. Note how they are popped in the reverse order from how they were pushed, to account for the last-in, first-out discipline of a stack.

## *Practice Problem 3.34 (solution page 340)*

Consider a function `P`, which generates local values, named `a0-a8`. It then calls function `q` using these generated values as arguments. Gcc produces the following code for the first part of `P`:

```

|
|
|   long P(long x)
|   x in %rdi
1   P:
2   pushq  %r15
3   pushq  %r14
4   pushq  %r13
5   pushq  %r12
6   pushq  %rbp
7   pushq  %rbx
8   subq   $24, %rsp
9   movq   %rdi, %rbx
10  leaq   1(%rdi), %r15
11  leaq   2(%rdi), %r14
12  leaq   3(%rdi), %r13
13  leaq   4(%rdi), %r12
14  leaq   5(%rdi), %rbp
15  leaq   6(%rdi), %rax
16  movq   %rax, (%rsp)
17  leaq   7(%rdi), %rdx
18  movq   %rdx, 8(%rsp)
19  movl   $0, %eax
20  call   Q
|   ...


```

A. Identify which local values get stored in callee-saved registers.

- B. Identify which local values get stored on the stack.
- C. Explain why the program could not store all of the local values in callee-saved registers.

## 3.7.6 Recursive Procedures

The conventions we have described for using the registers and the stack allow x86-64 procedures to call themselves recursively. Each procedure call has its own private space on the stack, and so the local variables of the multiple outstanding calls do not interfere with one another. Furthermore, the stack discipline naturally provides the proper policy for allocating local storage when the procedure is called and deallocating it before returning.

**Figure 3.35**  shows both the C code and the generated assembly code for a recursive factorial function. We can see that the assembly code uses register `%rbx` to hold the parameter `n`, after first saving the existing value on the stack (line 2) and later restoring the value before returning (line 11). Due to the stack discipline, and the register-saving conventions, we can be assured that when the recursive call to `rfact(n-1)` returns (line 9) that (1) the result of the call will be held in register



(a) C code

```
|  
long rfact(long n)  
{  
    long result;  
    if (n <= 1)  
        result = 1;  
    else  
        result = n * rfact(n-1);  
    return result;  
}
```

(b) Generated assembly code

```

|
|
|   long rfact(long n)
|   n in %rdi
1   rfact:
2   pushq   %rbx           Save %rbx
3   movq    %rdi, %rbx    Store n in callee-saved register
4   movl    $1, %eax      Set return value = 1
5   cmpq    $1, %rdi      Compare n:1
6   jle     .L35           If <=, goto done
7   leaq   -1(%rdi), %rdi Compute n-1
8   call   rfact           Call rfact(n-1)
9   imulq  %rbx, %rax      Multiply result by n
10  .L35:                 done:
11  popq    %rbx           Restore %rbx
12  ret                                Return

```

### Figure 3.35 Code for recursive factorial program.

The standard procedure handling mechanisms suffice for implementing recursive functions.

`%rax`, and (2) the value of argument `n` will held in register `%rbx`. Multiplying these two values then computes the desired result.

We can see from this example that calling a function recursively proceeds just like any other function call. Our stack discipline provides a mechanism where each invocation of a function has its own private storage for state information (saved values of the return

location and callee-saved registers). If need be, it can also provide storage for local variables. The stack discipline of allocation and deallocation naturally matches the call-return ordering of functions. This method of implementing function calls and returns even works for more complex patterns, including mutual recursion (e.g., when procedure **P** calls **Q**, which in turn calls **P**).

## Practice Problem 3.35 (solution page 340)

For a C function having the general structure

```
|  
long rfun(unsigned long x) {  
    if(_____  
        return _____;  
    unsigned long nx = _____;  
    long rv = rfun(nx);  
    return _____;  
}
```

gcc generates the following assembly code:

```

|
|
|   long rfun(unsigned long x)
|   x in %rdi
1   rfun:
2       pushq   %rbx
3       movq    %rdi, %rbx
4       movl   $0, %eax
5       testq  %rdi, %rdi
6       je     .L2
7       shrq   $2, %rdi
8       call  rfun
9       addq  %rbx, %rax
10      .L2:
11      popq  %rbx
12      ret

```

- A. What value does `rfun` store in the callee-saved register `%rbx`?
- B. Fill in the missing expressions in the C code shown above.

## 3.8 Array Allocation and Access

Arrays in C are one means of aggregating scalar data into larger data types. C uses a particularly simple implementation of arrays, and hence the translation into machine code is fairly straightforward. One unusual feature of C is that we can generate pointers to elements within arrays and perform arithmetic with these pointers. These are translated into address computations in machine code.

Optimizing compilers are particularly good at simplifying the address computations used by array indexing. This can make the correspondence between the C code and its translation into machine code somewhat difficult to decipher.

## 3.8.1 Basic Principles

For data type  $T$  and integer constant  $N$ , consider a declaration of the form

```
T A[N]
```

Let us denote the starting location as  $x_A$ . The declaration has two effects. First, it allocates a contiguous region of  $L \cdot N$  bytes in memory, where  $L$  is the size (in bytes) of data type  $T$ . Second, it introduces an identifier  $A$  that can be used as a pointer to the beginning of the array. The value of this pointer will be  $x_A$ . The array elements can be accessed using an integer index ranging between 0 and  $N-1$ . Array element  $i$  will be stored at address  $x_A + L \cdot i$ .

As examples, consider the following declarations:

```
char A[12];  
char *B[8];  
int C[6];  
double *D[5];
```

These declarations will generate arrays with the following parameters:

Array **A** consists of 12 single-byte (char) elements. Array **C** consists of 6 integers, each requiring 4 bytes. **B** and **D** are both arrays of pointers, and hence the array elements are 8 bytes each.

The memory referencing instructions of x86-64 are designed to simplify array access. For example, suppose **E** is an array of values of type int and we wish to evaluate **E[i]**, where the address of **E** is stored in register `%rdx` and *i* is stored in register `%rcx`. Then the instruction

```
movl (%rdx,%rcx,4),%eax
```

will perform the address computation  $x_E + 4i$ , read that memory location, and copy the result to register `%eax`. The allowed scaling factors of 1, 2, 4, and 8 cover the sizes of the common primitive data types.



## Practice Problem 3.36 (solution page 341)

Consider the following declarations:

```
|  
short S[7];  
short *T[3];  
short **U[6];  
int V[8];  
double *W[4];
```

Fill in the following table describing the element size, the total size, and the address of element  $i$  for each of these arrays.

## 3.8.2 Pointer Arithmetic

C allows arithmetic on pointers, where the computed value is scaled according to the size of the data type referenced by the pointer. That is, if `p` is a pointer to data of type  $T$ , and the value of `p` is  $x_p$ , then the expression `p+i` has value  $x_p + L \cdot i$ , where  $L$  is the size of data type  $T$ .

The unary operators `&` and `*` allow the generation and dereferencing of pointers. That is, for an expression `Expr` denoting some object, `&Expr` is a pointer giving the address of the object. For an expression `AExpr` denoting an address, `*AExpr` gives the value at that address. The expressions `Expr` and `*&Expr` are therefore equivalent. The array subscripting operation can be applied to both arrays and pointers. The array reference `A[i]` is identical to the expression `*(A+i)`. It computes the address of the  $i$ th array element and then accesses this memory location.

Expanding on our earlier example, suppose the starting address of integer array `E` and integer index  $i$  are stored in registers `%rdx` and `%rcx`, respectively. The following are some expressions involving `E`. We also show an assembly-code implementation of each expression, with the result being stored in either register `%eax` (for data) or register `%rax` (for pointers).

In these examples, we see that operations that return array values have type `int`, and hence involve 4-byte operations (e.g., `movl`) and registers (e.g., `%eax`). Those that return pointers have type `int *`, and hence involve 8-byte operations (e.g., `leaq`) and registers (e.g., `%rax`). The final example shows that one can compute the difference of two pointers within the same data structure, with the result being data having type `long` and value equal to the difference of the two addresses divided by the size of the data type.

## *Practice Problem 3.37 (solution page 341)*

Suppose  $x_s$ , the address of short integer array `s`, and long integer index  $i$  are stored in registers `%rdx` and `%rcx`, respectively. For each of the following expressions, give its type, a formula for its value, and an assembly-code implementation. The result should be stored in register `%rax` if it is a pointer and register element `%ax` if it has data type `short`.

## 3.8.3 Nested Arrays

The general principles of array allocation and referencing hold even when we create arrays of arrays. For example, the declaration

```
int A[5][3];
```

is equivalent to the declaration

```
typedef int row3_t[3];  
row3_t A[5];
```

Data type `row3_t` is defined to be an array of three integers. Array `A` contains five such elements, each requiring 12 bytes to store the three integers. The total array size is then  $4 \cdot 5 \cdot 3 = 60$  bytes.

Array `A` can also be viewed as a two-dimensional array with five rows and three columns, referenced as `A[0][0]` through `A[4][2]`. The array elements are ordered in memory in *row-major* order, meaning all elements of row 0, which can be written `A[0]`, followed by all elements of row 1 (`A[1]`), and so on. This is illustrated in

**Figure 3.36** .

This ordering is a consequence of our nested declaration. Viewing `A` as an array of five elements, each of which is an array of three `int`'s, we first have `A[0]`, followed by `A[1]`, and so on.

To access elements of multidimensional arrays, the compiler generates code to compute the offset of the desired element and then uses one of the `MOV` instructions with the start of the array as the base address and the (possibly scaled) offset as an index. In general, for an array declared as

```
T D[R][C];
```

array element `D[i][j]` is at memory address

$$\&D[i][j] = x_D + L(C \cdot i + j) \quad (3.1)$$

Row	Element	Address
A[0]	A[0][0]	$x_A$
	A[0][1]	$x_A + 4$
	A[0][2]	$x_A + 8$
A[1]	A[1][0]	$x_A + 12$
	A[1][1]	$x_A + 16$
	A[1][2]	$x_A + 20$
A[2]	A[2][0]	$x_A + 24$
	A[2][1]	$x_A + 28$
	A[2][2]	$x_A + 32$
A[3]	A[3][0]	$x_A + 36$
	A[3][1]	$x_A + 40$
	A[4][2]	$x_A + 44$

Figure 3.36 Elements of array in row-major order.

where  $L$  is the size of data type  $T$  in bytes. As an example, consider the  $5 \times 3$  integer array `A` defined earlier. Suppose  $x_A$ ,  $i$ , and  $j$  are in registers `%rdi`, `%rsi`, and `%rdx`, respectively. Then array element `A[i][j]` can be copied to register `%eax` by the following code:

```

|
|
|   A in %rdi, i in %rsi, and j in %rdx
1   leaq    (%rsi,%rsi,2), %rax      Compute 3i
2   leaq    (%rdi,%rax,4), %rax     Compute  $x_A + 12i$ 
3   movl    (%rax,%rdx,4), %eax     Read from  $M[x_A +$ 
|    $12i + 4j]$ 

```

As can be seen, this code computes the element's address as  $x_A + 12i + 4j = x_A + 4(3i + j)$  using the scaling and addition capabilities of

x86-64 address arithmetic.

## Practice Problem 3.38 (solution page 341)

Consider the following source code, where  $M$  and  $N$  are constants declared with `#define`:

```
|  
long P[M][N];  
long Q[N][M];  
long sum_element(long i, long j) {  
    return P[i][j] + Q[j][i];  
}
```

In compiling this program, gcc generates the following assembly code:



```

|
long sum_element(long i, long j)
i in %rdi, j in %rsi
1  sum_element:
2  leaq  0(,%rdi,8), %rdx
3  subq  %rdi, %rdx
4  addq  %rsi, %rdx
5  leaq  (%rsi,%rsi,4), %rax
6  addq  %rax, %rdi
7  movq  Q(,%rdi,8), %rax
8  addq  P(,%rdx,8), %rax
9  ret



```

Use your reverse engineering skills to determine the values of  $M$  and  $N$  based on this assembly code.

## 3.8.4 Fixed-Size Arrays

The C compiler is able to make many optimizations for code operating on multidimensional arrays of fixed size. Here we demonstrate some of the optimizations made by `gcc` when the optimization level is set with the flag `-O1`. Suppose we declare data type `fix_matrix` to be  $16 \times 16$  arrays of integers as follows:

```
#define N 16
typedef int fix_matrix[N][N];
```

(This example illustrates a good coding practice. Whenever a program uses some constant as an array dimension or buffer size, it is best to associate a name with it via a `#define` declaration, and then use this name consistently, rather than the numeric value. That way, if an occasion ever arises to change the value, it can be done by simply modifying the `#define` declaration.) The code in [Figure 3.37\(a\)](#)  computes element  $i, k$  of the product of arrays `A` and `B`—that is, the inner product of row  $i$  from `A` and column  $k$  from `B`. This product is given by the formula  $\sum_{0 \leq j < N} a_{i,j} \cdot b_{j,k}$ . `Gcc` generates code that we then recoded into C, shown as function `fix_prod_ele_opt` in [Figure 3.37\(b\)](#) . This code contains a number of clever optimizations. It removes the integer index `j` and converts all array references to pointer dereferences. This involves (1)

generating a pointer, which we have named `Aptr`, that points to successive elements in row  $i$  of `A`, (2) generating a pointer, which we have named `Bptr`, that points to successive elements in column  $k$  of `B`, and (3) generating a pointer, which we have named `Bend`, that equals the value `Bptr` will have when it is time to terminate the loop. The initial value for `Aptr` is the address of the first element of row  $i$  of `A`, given by the C expression `&A[i][0]`. The initial value for `Bptr` is the address of the first element of column  $k$  of `B`, given by the C expression `&B[0][k]`. The value for `Bend` is the index of what would be the  $(n + 1)$ st element in column  $k$  of `B`, given by the C expression `&B[N][k]`.

(a) Original C code

```
|  
/* Compute i,k of fixed matrix product */  
int fix_prod_ele (fix_matrix A, fix_matrix B, long i, long k) {  
    long j;  
    int result = 0;  
  
    for (j = 0; j < N; j++)  
        result += A[i][j] * B[j][k];  
    return result;  
}
```

(b) Optimized C code

```

1      /* Compute i,k of fixed matrix product */
2      int fix_prod_ele_opt(fix_matrix A, fix_matrix B, long i,
long k) {
3          int *Aptr = &A[i][0]; /* Points to elements in
row i of A */
4          int *Bptr = &B[0][k]; /* Points to elements in
column k of B */
5          int *Bend = &B[N][k]; /* Marks stopping point
for Bptr */
6          int result = 0;
7          do { /* No
need for initial test */
8              result += *Aptr * *Bptr; /* Add
next product to sum */
9              Aptr++; /* Move
Aptr to next column */
10             Bptr += N; /* Move
Bptr to next row */
11         } while (Bptr != Bend); /* Test
for stopping point */
12         return result;
13     }

```

**Figure 3.37** Original and optimized code to compute element  $i, k$  of matrix product for fixed-length arrays.

The compiler performs these optimizations automatically.

The following is the actual assembly code generated by gcc for function `fix_prod_ele`. We see that four registers are used as follows: `%eax` holds result, `%rdi` holds `Aptr`, `%rcx` holds `Bptr`, and `%rsi` holds `Bend`.

```

|
|
|   int fix_prod_ele_opt(fix_matrix A, fix_matrix B, long i,
|   long k)
|
|   A in %rdi, B in %rsi, i in %rdx, k in %rcx
1   fix_prod_ele:
2       salq    $6, %rdx           Compute 64 * i
3       addq    %rdx, %rdi        Compute Aptr = xA + 64i
|   = &A[i][0]
4       leaq   (%rsi,%rcx,4), %rcx  Compute Bptr = xB + 4k =
|   &B[0][k]
5       leaq   1024(%rcx), %rsi     Compute Bend = xB + 4k +
|   1024 = &B[N][k]
6       movl   $0, %eax           Set result = 0
7       .L7:      loop:
8       movl   (%rdi), %edx        Read *Aptr
9       imull  (%rcx), %edx        Multiply by *Bptr
10      addl   %edx, %eax          Add to result
11      addq   $4, %rdi            Increment Aptr ++
12      addq   $64, %rcx          Increment Bptr += N
13      cmpq   %rsi, %rcx         Compare Bptr:Bend
14      jne    .L7                If !=, goto loop
15      rep; ret                  Return

```

## *Practice Problem 3.39 (solution page 342)*

Use [Equation 3.1](#) to explain how the computations of the initial values for `Aptr`, `Bptr`, and `Bend` in the C code of [Figure 3.37\(b\)](#) (lines 3–5) correctly describe their computations in the assembly code generated for `fix_prod_ele` (lines 3–5).



## Practice Problem 3.40 (solution page 342)

The following C code sets the diagonal elements of one of our fixed-size arrays to `val`:

```
/* Set all diagonal elements to val */
void fix_set_diag(fix_matrix A, int val) {
    long i;
    for (i = 0; i < N; i++)
        A[i][i] = val;
}
```

When compiled with optimization level `-O1`, `gcc` generates the following assembly code:

```

1      fix_set_diag:
      void fix_set_diag(fix_matrix A, int val)
      A in %rdi, val in %rsi
2          movl    $0, %eax
3      .L13:
4          movl    %esi, (%rdi,%rax)
5          addq    $68, %rax
6          cmpq    $1088, %rax
7          jne     .L13
8          rep; ret

```

Create a C code program `fix_set_diag_opt` that uses optimizations similar to those in the assembly code, in the same style as the code in [Figure 3.37\(b\)](#). Use expressions involving the parameter  $N$  rather than integer constants, so that your code will work correctly if  $N$  is redefined.

## 3.8.5 Variable-Size Arrays

Historically, C only supported multidimensional arrays where the sizes (with the possible exception of the first dimension) could be determined at compile time. Programmers requiring variable-size arrays had to allocate storage for these arrays using functions such as `malloc` or `calloc`, and they had to explicitly encode the mapping of multidimensional arrays into single-dimension ones via row-major indexing, as expressed in [Equation 3.1](#). ISO C99 introduced the capability of having array dimension expressions that are computed as the array is being allocated.

In the C version of variable-size arrays, we can declare an array

```
int A[expr1] [expr2]
```

either as a local variable or as an argument to a function, and then the dimensions of the array are determined by evaluating the expressions *expr1* and *expr2* at the time the declaration is encountered. So, for example, we can write a function to access element *i, j* of an  $n \times n$  array as follows:

```

|
int var_ele(long n, int A[n][n], long i, long j) {
    return A[i][j];
}

```

The parameter `n` must precede the parameter `A[n][n]`, so that the function can compute the array dimensions as the parameter is encountered.

Gcc generates code for this referencing function as

```

|
    int var_ele(long n, int A[n][n], long i, long j)
    n in %rdi, A in %rsi, i in %rdx, j in %rcx
1   var_ele:
2       imulq   %rdx, %rdi           Compute
    n · i
3       leaq   (%rsi,%rdi,4), %rax   Compute
    xA + 4(n · i)
4       movl   (%rax,%rcx,4), %eax   Read
    from M[xA + 4(n · i) + 4j]
5       ret

```

As the annotations show, this code computes the address of element  $i, j$  as  $x_A + 4(n \cdot i) + 4j = x_A + 4(n \cdot i + j)$ . The address computation is similar to that of the fixed-size array ([Section 3.8.3](#)), except that

(1) the register usage changes due to added parameter `n`, and (2) a multiply instruction is used (line 2) to compute  $n \cdot i$ , rather than an `leaq` instruction to compute  $3i$ . We see therefore that referencing variable-size arrays requires only a slight generalization over fixed-size ones. The dynamic version must use a multiplication instruction to scale  $i$  by  $n$ , rather than a series of shifts and adds. In some processors, this multiplication can incur a significant performance penalty, but it is unavoidable in this case.

When variable-size arrays are referenced within a loop, the compiler can often optimize the index computations by exploiting the regularity of the access patterns. For example, [Figure 3.38\(a\)](#) shows C code to compute element  $i, k$  of the product of two  $n \times n$  arrays `A` and `B`. Gcc generates assembly code, which we have recast into C ([Figure 3.38\(b\)](#)). This code follows a different style from the optimized code for the fixed-size array ([Figure 3.37](#)), but that is more an artifact of the choices made by the compiler, rather than a fundamental requirement for the two different functions. The code of [Figure 3.38\(b\)](#) retains loop variable `j`, both to detect when

(a) Original C code

```
|  
1      /* Compute i,k of variable matrix product */  
2      int var_prod_ele(long n, int A[n][n], int B[n][n], long  
i, long k) {  
3          long j;  
4          int result = 0;  
5  
6          for (j = 0; j < n; j++)  
7              result += A[i][j] * B[j][k];  
8  
9          return result;  
10     }
```

(b) Optimized C code

```

|
/* Compute i,k of variable matrix product */
int var_prod_ele_opt(long n, int A[n][n], int B[n][n], long i,
long k) {
    int *Arow = A[i];
    int *Bptr = &B[0][k];
    int result = 0;
    long j;
    for (j = 0; j < n; j++) {
        result += Arow[j] * *Bptr;
        Bptr += n;
    }
    return result;
}

```

**Figure 3.38 Original and optimized code to compute element  $i, k$  of matrix product for variable-size arrays.**

The compiler performs these optimizations automatically.

the loop has terminated and to index into an array consisting of the elements of row  $i$  of `A`.




The following is the assembly code for the loop of `var_prod_ele`:

```

Registers: n in %rdi, Arow in %rsi, Bptr in %rcx
4n in %r9, result in %eax, j in %edx
1   .L24:                                loop:
2   movl   (%rsi,%rdx,4), %r8d           Read Arow[j]
3   imull  (%rcx), %r8d                 Multiply by *Bptr
4   addl   %r8d, %eax                   Add to result
5   addq   $1, %rdx                     j++
6   addq   %r9, %rcx                   Bptr += n
7   cmpq   %rdi, %rdx                  Compare j:n
8   jne    .L24                         If !=, goto loop

```

We see that the program makes use of both a scaled value  $4n$  (register `%r9`) for incrementing `Bptr` as well as the value of  $n$  (register `%rdi`) to check the loop bounds. The need for two values does not show up in the C code, due to the scaling of pointer arithmetic.

We have seen that, with optimizations enabled, `gcc` is able to recognize patterns that arise when a program steps through the elements of a multidimensional array. It can then generate code that avoids the multiplication that would result from a direct application of [Equation 3.1](#) . Whether it generates the pointer-based code of [Figure 3.37\(b\)](#)  or the array-based code of [Figure 3.38\(b\)](#) , these optimizations will significantly improve program performance.



## 3.9 Heterogeneous Data Structures

C provides two mechanisms for creating data types by combining objects of different types: *structures*, declared using the keyword `struct`, aggregate multiple objects into a single unit; *unions*, declared using the keyword `union`, allow an object to be referenced using several different types.

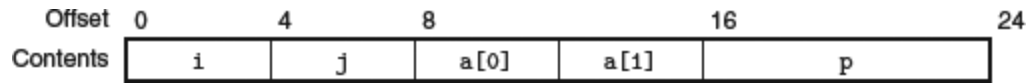
## 3.9.1 Structures

The C `struct` declaration creates a data type that groups objects of possibly different types into a single object. The different components of a structure are referenced by names. The implementation of structures is similar to that of arrays in that all of the components of a structure are stored in a contiguous region of memory and a pointer to a structure is the address of its first byte. The compiler maintains information about each structure type indicating the byte offset of each field. It generates references to structure elements using these offsets as displacements in memory referencing instructions.

As an example, consider the following structure declaration:

```
|  
struct rec {  
    int i;  
    int j;  
    int a[2];  
    int *p;  
};
```

This structure contains four fields: two 4-byte values of type `int`, a two-element array of type `int`, and an 8-byte integer pointer, giving a total of 24 bytes:



Observe that array `a` is embedded within the structure. The numbers along the top of the diagram give the byte offsets of the fields from the beginning of the structure.

To access the fields of a structure, the compiler generates code that adds the appropriate offset to the address of the structure. For example, suppose variable `r`

# New to C? Representing an object as a `struct`

The `struct` data type constructor is the closest thing C provides to the objects of C++ and Java. It allows the programmer to keep information about some entity in a single data structure and to reference that information with names.

For example, a graphics program might represent a rectangle as a structure:

```
|  
struct rect {  
    long llx;          /* X coordinate of lower-  
left corner */  
    long lly;          /* Y coordinate of lower-  
left corner */  
    unsigned long width; /* Width (in pixels)  
*/  
    unsigned long height; /* Height (in pixels)  
*/  
    unsigned color;    /* Coding of color  
*/  
};
```

We can declare a variable `r` of type `struct rect` and set its field values as follows:

```
|  
struct rect r;  
r.llx = r.lly = 0;  
r.color = 0xFF00FF;  
r.width = 10;  
r.height = 20;
```

where the expression `r.llx` selects field `llx` of structure `r`.

Alternatively, we can both declare the variable and initialize its fields with a single statement:

```
|  
struct rect r = { 0, 0, 0xFF00FF, 10, 20 };
```

It is common to pass pointers to structures from one place to another rather than copying them. For example, the following function computes the area of a rectangle, where a pointer to the rectangle `struct` is passed to the function:

```
|  
long area(struct rect *rp) {  
    return (*rp).width * (*rp).height;  
}
```

The expression `(*rp).width` dereferences the pointer and selects the width field of the resulting structure. Parentheses are required, because the compiler would interpret the expression `*rp.width` as `*(rp.width)`, which is not valid. This combination of dereferencing and field selection is so common that C provides an alternative notation using `->`. That is, `rp->width` is equivalent to the expression `(*rp).width`. For example, we can write a function that rotates a rectangle counterclockwise by 90 degrees as

```
|  
void rotate_left(struct rect *rp) {  
    /* Exchange width and height */  
    long t = rp->height;  
    rp->height = rp->width;  
    rp->width = t;  
    /* Shift to new lower-left corner */  
    rp->llx -= t;  
}
```

The objects of C++ and Java are more elaborate than structures in C, in that they also associate a set of *methods* with an object that can be invoked to perform computation. In C, we would simply write these as ordinary functions, such as the functions `area` and `rotate_left` shown previously.

of type `struct rec *` is in register `%rdi`. Then the following code copies element `r->i` to element `r->j`:

```
|  
|  
| Registers: r in %rdi  
1 movl (%rdi), %eax Get r->i  
2 movl %eax, 4(%rdi) Store in r->j
```

Since the offset of field `i` is 0, the address of this field is simply the value of `r`. To store into field `j`, the code adds offset 4 to the address of `r`.

To generate a pointer to an object within a structure, we can simply add the field's offset to the structure address. For example, we can generate the pointer `&(r->a[1])` by adding offset  $8 + 4 \cdot 1 = 12$ . For pointer `r` in register `%rdi` and long integer variable `i` in register `%rsi`, we can generate the pointer value `&(r->a[i])` with the single instruction

```

|
|
|   Registers: r in %rdi, i %rsi
1   leaq    8(%rdi,%rsi,4), %rax   Set %rax to &r->a[i]

```

As a final example, the following code implements the statement

```

|
|
|   r->p = &r->a[r->i + r->j];

```

starting with `r` in register `%rdi`:

```

|
|
|   Registers: r in %rdi
1   movl    4(%rdi), %eax          Get r->j
2   addl    (%rdi), %eax          Add r->i
3   cltq
|   Extend to 8 bytes
4   leaq    8(%rdi,%rax,4), %rax   Compute &r->a[r->i + r-
|   >j]
5   movq    %rax, 16(%rdi)        Store in r->p

```

As these examples show, the selection of the different fields of a structure is handled completely at compile time. The machine code contains no information about the field declarations or the names of the fields.



## Practice Problem 3.41 (solution page 343)

Consider the following structure declaration:

```
|  
struct prob {  
    int *p;  
    struct {  
        int x;  
        int y;  
    } s;  
    struct prob *next;  
};
```

This declaration illustrates that one structure can be embedded within another, just as arrays can be embedded within structures and arrays can be embedded within arrays. The following procedure (with some expressions omitted) operates on this structure:

```
|  
void sp_init(struct prob *sp) {  
    sp->s.x = _____;  
    sp->p = _____;  
    sp->next = _____;  
}
```

A. What are the offsets (in bytes) of the following fields?

```
|  
p: _____  
s.x: _____  
s.y: _____  
next: _____
```

B. How many total bytes does the structure require?

C. The compiler generates the following assembly code for `sp_init`:

```
|  
  
void sp_init(struct prob *sp)  
sp in %rdi  
1 sp_init:  
2 movl 12(%rdi), %eax  
3 movl %eax, 8(%rdi)  
4 leaq 8(%rdi), %rax  
5 movq %rax, (%rdi)  
6 movq %rdi, 16(%rdi)  
7 ret
```

On the basis of this information, fill in the missing expressions in the code for `sp_init`.

## Practice Problem 3.42 (solution page 343)

The following code shows the declaration of a structure of type `ELE` and the prototype for a function `fun`:

```
|
struct ELE {
    long v;
    struct ELE *p;
};

long fun(struct ELE *ptr);
```

When the code for `fun` is compiled, gcc generates the following assembly code:

```
|  
    long fun(struct ELE *ptr)  
    ptr in %rdi  
1    fun:  
2    movl    $0, %eax  
3    jmp     .L2  
4    L3:  
5    addq   (%rdi), %rax  
6    movq   8(%rdi), %rdi  
7    .L2:  
8    testq  %rdi, %rdi  
9    jne    .L3  
10   rep; ret
```

- A. Use your reverse engineering skills to write C code for `fun`.
- B. Describe the data structure that this structure implements and the operation performed by `fun`.

## 3.9.2 Unions

Unions provide a way to circumvent the type system of C, allowing a single object to be referenced according to multiple types. The syntax of a union declaration is identical to that for structures, but its semantics are very different. Rather than having the different fields reference different blocks of memory, they all reference the same block.

Consider the following declarations:

```
|  
struct S3 {  
    char c;  
    int i[2];  
    double v;  
};  
union U3 {  
    char c;  
    int i[2];  
    double v;  
};
```

When compiled on an x86-64 Linux machine, the offsets of the fields, as well as the total size of data types `S3` and `U3`, are as shown in the following table:

(We will see shortly why `i` has offset 4 in `s3` rather than 1, and why `v` has offset 16, rather than 9 or 12.) For pointer `p` of type union `U3`\*, references `p->c`, `p->i[0]`, and `p->v` would all reference the beginning of the data structure. Observe also that the overall size of a union equals the maximum size of any of its fields.

Unions can be useful in several contexts. However, they can also lead to nasty bugs, since they bypass the safety provided by the C type system. One application is when we know in advance that the use of two different fields in a data structure will be mutually exclusive. Then, declaring these two fields as part of a union rather than a structure will reduce the total space allocated.

For example, suppose we want to implement a binary tree data structure where each leaf node has two `double` data values and each internal node has pointers to two children but no data. If we declare this as

```
|  
struct node_s {  
    struct node_s *left;  
    struct node_s *right;  
    double data[2];  
};
```

then every node requires 32 bytes, with half the bytes wasted for each type of node. On the other hand, if we declare a node as

```
|  
union node_u {  
    struct {  
        union node_u *left;  
        union node_u *right;  
    } internal;  
    double data[2];  
};
```

then every node will require just 16 bytes. If `n` is a pointer to a node of type union `node_u *`, we would reference the data of a leaf node as `n->data[0]` and `n->data[1]`, and the children of an internal node as `n->internal.left` and `n->internal.right`.

With this encoding, however, there is no way to determine whether a given node is a leaf or an internal node. A common method is to introduce an enumerated type defining the different possible choices for the union, and then create a structure containing a tag field and the union:

```

|
typedef enum { N_LEAF, N_INTERNAL } nodetype_t;

struct node_t {
    nodetype_t type;
    union {
        struct {
            struct node_t *left;
            struct node_t *right;
        } internal;
        double data[2];
    } info;
};

```

This structure requires a total of 24 bytes: 4 for `type`, and either 8 each for `info.internal.left` and `info.internal.right` or 16 for `info.data`. As we will discuss shortly, an additional 4 bytes of padding is required between the field for `type` and the union elements, bringing the total structure size to  $4 + 4 + 16 = 24$ . In this case, the savings gain of using a union is small relative to the awkwardness of the resulting code. For data structures with more fields, the savings can be more compelling.

Unions can also be used to access the bit patterns of different data types. For example, suppose we use a simple cast to convert a value `d` of type `double` to a value `u` of type unsigned `long`:



```
unsigned long u = (unsigned long) d;
```

Value `u` will be an integer representation of `d`. Except for the case where `d` is 0.0, the bit representation of `u` will be very different from that of `d`. Now consider the following code to generate a value of type `unsigned long` from a `double`:

```
unsigned long double2bits(double d) {  
    union {  
        double d;  
        unsigned long u;  
    } temp;  
    temp.d = d;  
    return temp.u;  
};
```

In this code, we store the argument in the union using one data type and access it using another. The result will be that `u` will have the same bit representation as `d`, including fields for the sign bit, the exponent, and the significand, as described in [Section 3.11](#). The numeric value of `u` will bear no relation to that of `d`, except for the case when `d` is 0.0.

When using unions to combine data types of different sizes, byte-ordering issues can become important. For example, suppose we write a procedure that will create an 8-byte `double` using the bit patterns given by two 4-byte `unsigned` values:

```
|
double uu2double(unsigned word0, unsigned word1)
{
    union {
        double d;
        unsigned u[2];
    } temp;
    temp.u[0] = word0;
    temp.u[1] = word1;
    return temp.d;
}
```

On a little-endian machine, such as an x86-64 processor, argument `word0` will become the low-order 4 bytes of `d`, while `word1` will become the high-order 4 bytes. On a big-endian machine, the role of the two arguments will be reversed.

## Practice Problem 3.43 (solution page 344)

Suppose you are given the job of checking that a C compiler generates the proper code for structure and union access. You write the following structure declaration:

```
|  
typedef union {  
    struct {  
        long u;  
        short v;  
        char w;  
    } t1;  
    struct {  
        int a[2];  
        char *p;  
    } t2;  
} u_type;
```

You write a series of functions of the form

```
|  
void get(u_type *up, type *dest) {  
    *dest = expr;  
}
```

with different access expressions *expr* and with destination data type *type* set according to type associated with *expr*. You then examine the code generated when compiling the functions to see if they match your expectations.

Suppose in these functions that `up` and `dest` are loaded into registers `%rdi` and `%rsi`, respectively. Fill in the following table with data type *type* and sequences of one to three instructions to compute the expression and store the result at `dest`.

## 3.9.3 Data Alignment

Many computer systems place restrictions on the allowable addresses for the primitive data types, requiring that the address for some objects must be a multiple of some value  $K$  (typically 2, 4, or 8). Such *alignment restrictions* simplify the design of the hardware forming the interface between the processor and the memory system. For example, suppose a processor always fetches 8 bytes from memory with an address that must be a multiple of 8. If we can guarantee that any double will be aligned to have its address be a multiple of 8, then the value can be read or written with a single memory operation. Otherwise, we may need to perform two memory accesses, since the object might be split across two 8-byte memory blocks.

The x86-64 hardware will work correctly regardless of the alignment of data. However, Intel recommends that data be aligned to improve memory system performance. Their alignment rule is based on the principle that any primitive object of  $K$  bytes must have an address that is a multiple of  $K$ . We can see that this rule leads to the following alignments:

Alignment is enforced by making sure that every data type is organized and allocated in such a way that every object within the type satisfies its alignment restrictions. The compiler places directives in the assembly code indicating the desired alignment for global data. For example, the assembly-code declaration of the jump table on page 235 contains the following directive on line 2:

```
.align 8
```

This ensures that the data following it (in this case the start of the jump table) will start with an address that is a multiple of 8. Since each table entry is 8 bytes long, the successive elements will obey the 8-byte alignment restriction.

For code involving structures, the compiler may need to insert gaps in the field allocation to ensure that each structure element satisfies its alignment requirement. The structure will then have some required alignment for its starting address.

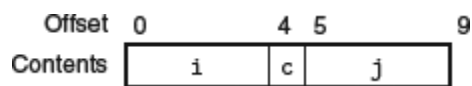
For example, consider the structure declaration

```

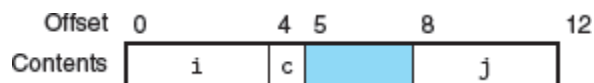
struct S1 {
    int i;
    char c;
    int j;
};

```

Suppose the compiler used the minimal 9-byte allocation, diagrammed as follows:



Then it would be impossible to satisfy the 4-byte alignment requirement for both fields `i` (offset 0) and `j` (offset 5). Instead, the compiler inserts a 3-byte gap (shown here as shaded in blue) between fields `c` and `j`:



As a result, `j` has offset 8, and the overall structure size is 12 bytes. Furthermore, the compiler must ensure that any pointer `p` of type `struct S1*` satisfies a 4-byte alignment. Using our earlier notation, let pointer `p` have value  $x_p$ . Then  $x_p$  must be a multiple of 4. This guarantees that both `p->i` (address  $x_p$ ) and `p->j` (address  $x_p + 8$ ) will satisfy their 4-byte alignment requirements.

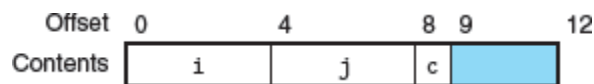
In addition, the compiler may need to add padding to the end of the structure so that each element in an array of structures will satisfy its alignment requirement. For example, consider the following structure declaration:

```
struct S2 {  
    int i;  
    int j;  
    char c;  
};
```

If we pack this structure into 9 bytes, we can still satisfy the alignment requirements for fields `i` and `j` by making sure that the starting address of the structure satisfies a 4-byte alignment requirement. Consider, however, the following declaration:

```
struct S2 d[4];
```

With the 9-byte allocation, it is not possible to satisfy the alignment requirement for each element of `d`, because these elements will have addresses  $x_d$ ,  $x_d + 9$ ,  $x_d + 18$ , and  $x_d + 27$ . Instead, the compiler allocates 12 bytes for structure `s2`, with the final 3 bytes being wasted space:





That way, the elements of `d` will have addresses  $x_d$ ,  $x_d + 12$ ,  $x_d + 24$ , and  $x_d + 36$ . As long as  $x_d$  is a multiple of 4, all of the alignment restrictions will be satisfied.

## *Practice Problem 3.44 (solution page 345)*

For each of the following structure declarations, determine the offset of each field, the total size of the structure, and its alignment requirement for x86-64:

- A. `struct P1 { int i; char c; int j; char d; };`
- B. `struct P2 { int i; char c; char d; long j; };`
- C. `struct P3 { short w[3]; char c[3] };`
- D. `struct P4 { short w[5]; char *c[3] };`
- E. `struct P5 { struct P3 a[2]; struct P2 t };`

## Practice Problem 3.45 (solution page 345)

Answer the following for the structure declaration

```
|  
struct {  
    char *a;  
    short b;  
    double c;  
    char d;  
    float e;  
    char f;
```

# Aside A case of mandatory alignment

For most x86-64 instructions, keeping data aligned improves efficiency, but it does not affect program behavior. On the other hand, some models of Intel and AMD processors will not work correctly with unaligned data for some of the SSE instructions implementing multimedia operations. These instructions operate on 16-byte blocks of data, and the instructions that transfer data between the SSE unit and memory require the memory addresses to be multiples of 16. Any attempt to access memory with an address that does not satisfy this alignment will lead to an *exception* (see [Section 8.1](#)), with the default behavior for the program to terminate.

As a result, any compiler and run-time system for an x86-64 processor must ensure that any memory allocated to hold a data structure that may be read from or stored into an SSE register must satisfy a 16-byte alignment. This requirement has the following two consequences:

- The starting address for any block generated by a memory allocation function (`alloca`, `malloc`, `calloc`, or `realloc`) must be a multiple of 16.
- The stack frame for most functions must be aligned on a 16-byte boundary. (This requirement has a

number of exceptions.)

More recent versions of x86-64 processors implement the AVX multimedia instructions. In addition to providing a superset of the SSE instructions, processors supporting AVX also do not have a mandatory alignment requirement.

```
|  
long g;  
int h;  
} rec;
```

- A. What are the byte offsets of all the fields in the structure?
- B. What is the total size of the structure?
- C. Rearrange the fields of the structure to minimize wasted space, and then show the byte offsets and total size for the rearranged structure.

## 3.10 Combining Control and Data in Machine-Level Programs

So far, we have looked separately at how machine-level code implements the control aspects of a program and how it implements different data structures. In this section, we look at ways in which data and control interact with each other. We start by taking a deep look into pointers, one of the most important concepts in the C programming language, but one for which many programmers only have a shallow understanding. We review the use of the symbolic debugger `GDB` for examining the detailed operation of machine-level programs. Next, we see how understanding machine-level programs enables us to study buffer overflow, an important security vulnerability in many real-world systems. Finally, we examine how machine-level programs implement cases where the amount of stack storage required by a function can vary from one execution to another.

## 3.10.1 Understanding Pointers

Pointers are a central feature of the C programming language. They serve as a uniform way to generate references to elements within different data structures. Pointers are a source of confusion for novice programmers, but the underlying concepts are fairly simple. Here we highlight some key principles of pointers and their mapping into machine code.

- **Every pointer has an associated type.** This type indicates what kind of object the pointer points to. Using the following pointer declarations as illustrations

```
int *ip; char **cpp;
```

variable `ip` is a pointer to an object of type `int`, while `cpp` is a pointer to an object that itself is a pointer to an object of type `char`. In general, if the object has type  $T$ , then the pointer has type  $*T$ . The special `void *` type represents a generic pointer. For example, the `malloc` function returns a generic pointer, which is converted to a typed pointer via either an explicit cast or by the implicit casting of the assignment operation. Pointer types are not part of machine code; they are an abstraction provided by C to help programmers avoid addressing errors.

- **Every pointer has a value.** This value is an address of some object of the designated type. The special `NULL (0)` value indicates that the pointer does not point anywhere.
- **Pointers are created with the `&` operator.** This operator can be applied to any C expression that is categorized as an *lvalue*, meaning an expression that can appear on the left side of an assignment. Examples include variables and the elements of structures, unions, and arrays. We have seen that the machine-code realization of the `&` operator often uses the `leaq` instruction to compute the expression value, since this instruction is designed to compute the address of a memory reference.
- **Pointers are dereferenced with the `*` operator.** The result is a value having the type associated with the pointer. Dereferencing is implemented by a memory reference, either storing to or retrieving from the specified address.
- **Arrays and pointers are closely related.** The name of an array can be referenced (but not updated) as if it were a pointer variable. Array referencing (e.g., `a[3]`) has the exact same effect as pointer arithmetic and dereferencing (e.g., `*(a+3)`). Both array referencing and pointer arithmetic require scaling the offsets by the object size. When we write an expression `p+i` for pointer `p` with value `p`, the resulting address is computed as  $p + L \cdot i$ , where  $L$  is the size of the data type associated with `p`.
- **Casting from one type of pointer to another changes its type but not its value.** One effect of casting is to change any scaling of pointer arithmetic. So, for example, if `p` is a pointer of type `char *` having value `p`, then the expression `(int *) p+7`

computes `p + 28`, while `(int *) (p+7)` computes `p + 7`. (Recall that casting has higher precedence than addition.)

- **Pointers can also point to functions.** This provides a powerful capability for storing and passing references to code, which can be invoked in some other part of the program. For example, if we have a function defined by the prototype

```
|  
int fun(int x, int *p);
```

then we can declare and assign a pointer `fp` to this function by the following code sequence:

```
int (*fp)(int, int *); fp = fun;
```

We can then invoke the function using this pointer:

```
|  
int y = 1;  
int result = fp(3, &y);
```

The value of a function pointer is the address of the first instruction in the machine-code representation of the function.



## New to C? Function pointers

The syntax for declaring function pointers is especially difficult for novice programmers to understand. For a declaration such as

```
|  
int (*f)(int*);
```

it helps to read it starting from the inside (starting with `f`) and working outward. Thus, we see that `f` is a pointer, as indicated by `*f`. It is a pointer to a function that has a single `int *` as an argument, as indicated by `(*f)(int*)`. Finally, we see that it is a pointer to a function that takes an `int *` as an argument and returns `int`.

The parentheses around `*f` are required, because otherwise the declaration

```
|  
int *f(int*);
```

would be read as


```
|  
(int *) f(int*);
```

That is, it would be interpreted as a function prototype, declaring a function `f` that has an `int *` as its argument and returns an `int *`.

Kernighan and Ritchie [61, Sect. 5.12] present a helpful tutorial on reading C declarations.

## 3.10.2 Life in the Real World: Using the GDB Debugger

The GNU debugger `GDB` provides a number of useful features to support the run-time evaluation and analysis of machine-level programs. With the examples and exercises in this book, we attempt to infer the behavior of a program by just looking at the code. Using `GDB`, it becomes possible to study the behavior by watching the program in action while having considerable control over its execution.

**Figure 3.39**  shows examples of some `GDB` commands that help when working with machine-level x86-64 programs. It is very helpful to first run `OBJDUMP` to get a disassembled version of the program. Our examples are based on running `GDB` on the file `prog`, described and disassembled on page 175. We start `GDB` with the following command line:

```
linux> gdb prog
```

The general scheme is to set breakpoints near points of interest in the program. These can be set to just after the entry of a function or at a program address. When one of the breakpoints is hit during program execution, the program will halt and return control to the

user. From a breakpoint, we can examine different registers and memory locations in various formats. We can also single-step the program, running just a few instructions at a time, or we can proceed to the next breakpoint.

As our examples suggest, `GDB` has an obscure command syntax, but the online help information (invoked within `GDB` with the `help` command) overcomes this shortcoming. Rather than using the command-line interface to `GDB`, many programmers prefer using `DDD`, an extension to `GDB` that provides a graphical user interface.

## 3.10.3 Out-of-Bounds Memory References and Buffer Overflow

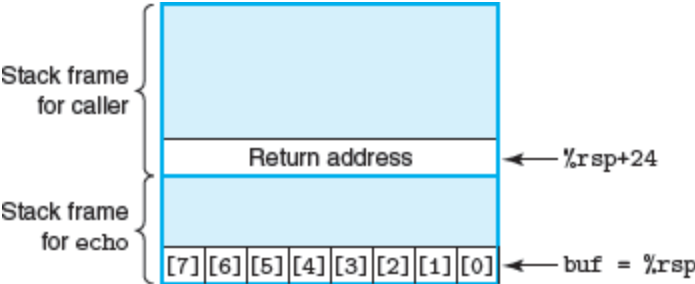
We have seen that C does not perform any bounds checking for array references, and that local variables are stored on the stack along with state information such as saved register values and return addresses. This combination can lead to serious program errors, where the state stored on the stack gets corrupted by a write to an out-of-bounds array element. When the program then tries to reload the register or execute a `ret` instruction with this corrupted state, things can go seriously wrong.

A particularly common source of state corruption is known as *buffer overflow*. Typically, some character array is allocated on the stack to hold a string, but the size of the string exceeds the space allocated for the array. This is demonstrated by the following program example:

```
|  
/* Implementation of library function gets() */  
char *gets(char *s)  
{  
    int c;  
    char *dest = s;
```

**Figure 3.39 Example GDB commands.**

These examples illustrate some of the ways GDB supports debugging of machine-level programs.



**Figure 3.40 Stack organization for `echo` function.**

Character array `buf` is just part of the saved state. An out-of-bounds write to `buf` can corrupt the program state.

```

|
while ((c = getchar()) != '\n' && c != EOF)
    *dest++ = c;
if (c == EOF && dest == s)
    /* No characters read */
    return NULL;
*dest++ = '\0'; /* Terminate string */
return s;
}
/* Read input line and write it back */
void echo()
{
    char buf[8]; /* Way too small! */
    gets(buf);
    puts(buf);
}


```

The preceding code shows an implementation of the library function `gets` to demonstrate a serious problem with this function. It reads a line from the standard input, stopping when either a terminating newline character or some error condition is encountered. It copies this string to the location designated by argument `s` and terminates the string with a null character. We show the use of `gets` in the function `echo`, which simply reads a line from standard input and echos it back to standard output.

The problem with `gets` is that it has no way to determine whether sufficient space has been allocated to hold the entire string. In our `echo` example, we have purposely made the buffer very small—just eight characters long. Any string longer than seven characters will cause an out-of-bounds write.

By examining the assembly code generated by `gcc` for `echo`, we can infer how the stack is organized:


```
|
|
|      void echo()
1      echo:
2      subq   $24, %rsp      Allocate 24 bytes on stack
3      movq   %rsp, %rdi    Compute buf as %rsp
4      call   gets          Call gets
5      movq   %rsp, %rdi    Compute buf as %rsp
6      call   puts          Call puts
7      addq   $24, %rsp     Deallocate stack space
8      ret                               Return
```

**Figure 3.40**  illustrates the stack organization during the execution of `echo`. The program allocates 24 bytes on the stack by subtracting 24 from the stack pointer (line 2). Character `buf` is positioned at the top of the stack, as can be seen by the fact that `%rsp` is copied to `%rdi` to be used as the argument to the calls to both `gets` and `puts`. The 16 bytes between `buf` and the stored return pointer are not




used. As long as the user types at most seven characters, the string returned by `gets` (including the terminating null) will fit within the space allocated for `buf`. A longer string, however, will cause `gets` to overwrite some of the information stored on the stack. As the string gets longer, the following information will get corrupted:

No serious consequence occurs for strings of up to 23 characters, but beyond that, the value of the return pointer, and possibly additional saved state, will be corrupted. If the stored value of the return address is corrupted, then the `ret` instruction (line 8) will cause the program to jump to a totally unexpected location. None of these behaviors would seem possible based on the C code. The impact of out-of-bounds writing to memory by functions such as `gets` can only be understood by studying the program at the machine-code level.

Our code for `echo` is simple but sloppy. A better version involves using the function `fgets`, which includes as an argument a count on the maximum number of bytes to read. **Problem 3.71**  asks you to write an `echo` function that can handle an input string of arbitrary length. In general, using `gets` or any function that can overflow storage is considered a bad programming practice. Unfortunately, a number of commonly used library functions, including `strcpy`, `strcat`, and `sprintf`, have the property that they can generate a byte sequence without being given any indication of the size of the destination buffer [97]. Such conditions can lead to vulnerabilities to buffer overflow.

## Practice Problem 3.46 (solution page 346)

Figure 3.41  shows a (low-quality) implementation of a function that reads a line from standard input, copies the string to newly allocated storage, and returns a pointer to the result.

Consider the following scenario. Procedure `get_line` is called with the return address equal to `0x400776` and register `%rbx` equal to `0x0123456789ABCDEF`. You type in the string

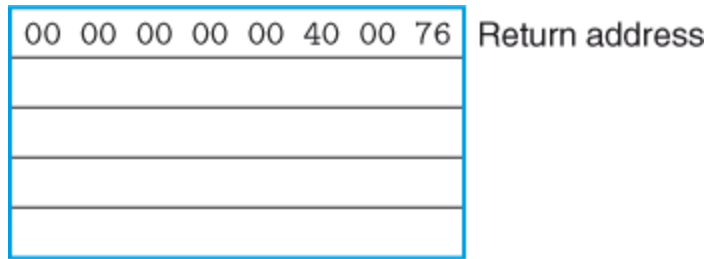
```
|  
0123456789012345678901234
```

(a) C code

```
|
/* This is very low-quality code.
   It is intended to illustrate bad programming
practices.
   See Practice Problem 3.46. */
char *get_line()
{
    char buf[4];
    char *result;
    gets(buf);
    result = malloc(strlen(buf));
    strcpy(result, buf);
    return result;
}
```

(b) Disassembly up through call to gets





- B. Modify your diagram to show the effect of the call to `gets` (line 5).
- C. To what address does the program attempt to return?
- D. What register(s) have corrupted value(s) when `get_line` returns?
- E. Besides the potential for buffer overflow, what two other things are wrong with the code for `get_line`?

A more pernicious use of buffer overflow is to get a program to perform a function that it would otherwise be unwilling to do. This is one of the most common methods to attack the security of a system over a computer network. Typically, the program is fed with a string that contains the byte encoding of some executable code, called the *exploit code*, plus some extra bytes that overwrite the return address with a pointer to the exploit code. The effect of executing the `ret` instruction is then to jump to the exploit code.

In one form of attack, the exploit code then uses a system call to start up a shell program, providing the attacker with a range of operating system functions. In another form, the exploit code performs some otherwise unauthorized task, repairs the damage to

the stack, and then executes `ret` a second time, causing an (apparently) normal return to the caller.

As an example, the famous Internet worm of November 1988 used four different ways to gain access to many of the computers across the Internet. One was a buffer overflow attack on the finger daemon `fingerd`, which serves requests by the `FINGER` command. By invoking `FINGER` with an appropriate string, the worm could make the daemon at a remote site have a buffer overflow and execute code that gave the worm access to the remote system. Once the worm gained access to a system, it would replicate itself and consume virtually all of the machine's computing resources. As a consequence, hundreds of machines were effectively paralyzed until security experts could determine how to eliminate the worm. The author of the worm was caught and prosecuted. He was sentenced to 3 years probation, 400 hours of community service, and a \$10,500 fine. Even to this day, however, people continue to find security leaks in systems that leave them vulnerable to buffer overflow attacks. This highlights the need for careful programming. Any interface to the external environment should be made "bulletproof" so that no behavior by an external agent can cause the system to misbehave.

## 3.10.4 Thwarting Buffer Overflow Attacks

Buffer overflow attacks have become so pervasive and have caused so many problems with computer systems that modern compilers and operating systems have implemented mechanisms to make it more difficult to mount these attacks and to limit the ways by which an intruder can seize control of a system via a buffer overflow attack. In this section, we will present mechanisms that are provided by recent versions of `gcc` for Linux.

# Stack Randomization

In order to insert exploit code into a system, the attacker needs to inject both the code as well as a pointer to this code as part of the attack string. Generating

## Aside Worms and viruses

Both worms and viruses are pieces of code that attempt to spread themselves among computers. As described by Spafford [105], a *worm* is a program that can run by itself and can propagate a fully working version of itself to other machines. A *virus* is a piece of code that adds itself to other programs, including operating systems. It cannot run independently. In the popular press, the term "virus" is used to refer to a variety of different strategies for spreading attacking code among systems, and so you will hear people saying "virus" for what more properly should be called a "worm."

this pointer requires knowing the stack address where the string will be located. Historically, the stack addresses for a program were highly predictable. For all systems running the same combination of program and operating system version, the stack locations were fairly stable across many machines. So, for example, if an attacker could determine the stack addresses used by a common Web server, it could devise an attack that would work on many machines. Using infectious disease as an analogy, many systems were vulnerable to the exact same strain of a virus, a phenomenon often referred to as a *security monoculture* [96].



The idea of *stack randomization* is to make the position of the stack vary from one run of a program to another. Thus, even if many machines are running identical code, they would all be using different stack addresses. This is implemented by allocating a random amount of space between 0 and  $n$  bytes on the stack at the start of a program, for example, by using the allocation function `alloca`, which allocates space for a specified number of bytes on the stack. This allocated space is not used by the program, but it causes all subsequent stack locations to vary from one execution of a program to another. The allocation range  $n$  needs to be large enough to get sufficient variations in the stack addresses, yet small enough that it does not waste too much space in the program.

The following code shows a simple way to determine a "typical" stack address:

```
|
int main(){
    long local;
    printf("local at %p\n", &local);
    return 0;
}
```

This code simply prints the address of a local variable in the main function. Running the code 10,000 times on a Linux machine in 32-bit mode, the addresses ranged from `0xff7fc59c` to `0xffffd09c`, a range of around  $2^{23}$ . Running in 64-bit mode on the newer machine,

the addresses ranged from `0x7fff0001b698` to `0x7fffffffaa4a8`, a range of nearly  $2^{32}$ .

Stack randomization has become standard practice in Linux systems. It is one of a larger class of techniques known as *address-space layout randomization*, or ASLR [99]. With ASLR, different parts of the program, including program code, library code, stack, global variables, and heap data, are loaded into different regions of memory each time a program is run. That means that a program running on one machine will have very different address mappings than the same program running on other machines. This can thwart some forms of attack.

Overall, however, a persistent attacker can overcome randomization by brute force, repeatedly attempting attacks with different addresses. A common trick is to include a long sequence of `nop` (pronounced "no op," short for "no operation") instructions before the actual exploit code. Executing this instruction has no effect, other than incrementing the program counter to the next instruction. As long as the attacker can guess an address somewhere within this sequence, the program will run through the sequence and then hit the exploit code. The common term for this sequence is a "nop sled" [97], expressing the idea that the program "slides" through the sequence. If we set up a 256-byte nop sled, then the randomization over  $n = 2^{23}$  can be cracked by enumerating  $2^{15} = 32,768$  starting addresses, which is entirely feasible for a determined attacker. For the 64-bit case, trying to enumerate  $2^{24} = 16,777,216$  is a bit more daunting. We can see that stack randomization and other aspects of


ASLR can increase the effort required to successfully attack a system, and therefore greatly reduce the rate at which a virus or worm can spread, but it cannot provide a complete safeguard.


## Practice Problem 3.47 (solution page [347](#))

Running our stack-checking code 10,000 times on a system running Linux version 2.6.16, we obtained addresses ranging from a minimum of `0xffffb754` to a maximum of `0xffffd754`.

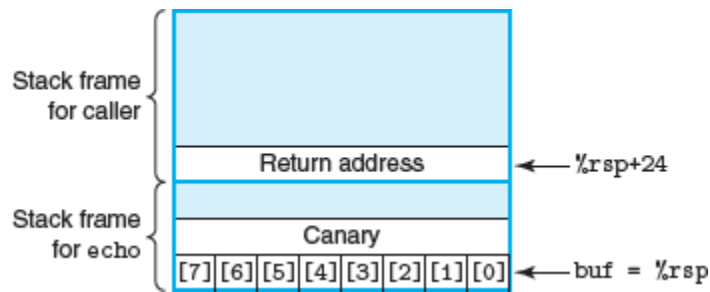
- A. What is the approximate range of addresses?
- B. If we attempted a buffer overrun with a 128-byte nopsled, about how many attempts would it take to test all starting addresses?

## Stack Corruption Detection

A second line of defense is to be able to detect when a stack has been corrupted. We saw in the example of the `echo` function ([Figure 3.40](#) ) that the corruption typically occurs when the program overruns the bounds of a local buffer. In C, there is no reliable way to prevent writing beyond the bounds of an array. Instead, the program can attempt to detect when such a write has occurred before it can have any harmful effects.

Recent versions of `gcc` incorporate a mechanism known as a *stack protector* into the generated code to detect buffer overruns. The idea is to store a special *canary* value<sup>4</sup> in the stack frame between any local buffer and the rest of the stack state, as illustrated in [Figure 3.42](#)  [26, 97]. This canary value, also referred to as a *guard value*, is generated randomly each time the program runs, and so there is no

<sup>4</sup>. The term "canary" refers to the historic use of these birds to detect the presence of dangerous gases in coal mines.



**Figure 3.42 Stack organization for `echo` function with stack protector enabled.**

A special "canary" value is positioned between array `buf` and the saved state. The code checks the canary value to determine whether or not the stack state has been corrupted.

easy way for an attacker to determine what it is. Before restoring the register state and returning from the function, the program checks if the canary has been altered by some operation of this function or one that it has called. If so, the program aborts with an error.

Recent versions of `gcc` try to determine whether a function is vulnerable to a stack overflow and insert this type of overflow detection automatically. In fact, for our earlier demonstration of stack overflow, we had to give the command-line option `-fno-stack-protector` to prevent `gcc` from inserting this code. Compiling the function `echo` without this option, and hence with the stack protector enabled, gives the following assembly code:

```

|
void echo()
1   echo:
2   subq   $24, %rsp      Allocate 24 bytes on stack
3   movq   %fs:40, %rax   Retrieve canary
4   movq   %rax, 8(%rsp)  Store on stack
5   xorl   %eax, %eax     Zero out register
6   movq   %rsp, %rdi     Compute buf as %rsp
7   call   gets           Call gets
8   movq   %rsp, %rdi     Compute buf as %rsp
9   call   puts           Call puts
10  movq   8(%rsp), %rax  Retrieve canary
11  xorq   %fs:40, %rax   Compare to stored value
12  je     .L9            If =, goto ok
13  call   __stack_chk_fail Stack corrupted!
14  .L9:                ok:
15  addq   $24, %rsp      Deallocate stack space
16  ret

```

We see that this version of the function retrieves a value from memory (line 3) and stores it on the stack at offset 8 from `%rsp`, just beyond the region allocated for `buf`. The instruction argument `%fs:40` is an indication that the canary value is read from memory using *segmented addressing*, an addressing mechanism that dates back to the 80286 and is seldom found in programs running on modern systems. By storing the canary in a special segment, it can be marked as "read only," so that an attacker cannot overwrite the

stored canary value. Before restoring the register state and returning, the function compares the value stored at the stack location with the canary value (via the `xorq` instruction on line 11). If the two are identical, the `xorq` instruction will yield zero, and the function will complete in the normal fashion. A nonzero value indicates that the canary on the stack has been modified, and so the code will call an error routine.

Stack protection does a good job of preventing a buffer overflow attack from corrupting state stored on the program stack. It incurs only a small performance penalty, especially because `gcc` only inserts it when there is a local buffer of type `char` in the function. Of course, there are other ways to corrupt the state of an executing program, but reducing the vulnerability of the stack thwarts many common attack strategies.

## Practice Problem 3.48 (solution page [347](#))

The functions `intlen`, `len`, and `iptoa` provide a very convoluted way to compute the number of decimal digits required to represent an integer. We will use this as a way to study some aspects of the gcc stack protector facility.

```
|
int len(char *s) {
    return strlen(s);
}
void iptoa(char *s, long *p) {
    long val = *p;
    sprintf(s, "%ld", val);
}
int intlen(long x) {
    long v;
    char buf[12];
    v = x;
    iptoa(buf, &v);
    return len(buf);
}
```

The following show portions of the code for `intlen`, compiled both with and without stack protector:

(a) Without protector



```

|
int intlen(long x)
x in %rdi
1 intlen:
2 subq $40, %rsp
3 movq %rdi, 24(%rsp)
4 leaq 24(%rsp), %rsi
5 movq %rsp, %rdi
6 call iptoa

```

(b) With protector

```

|
int intlen(long x)
x in %rdi
1 intlen:
2 subq $56, %rsp
3 movq %fs:40, %rax
4 movq %rax, 40(%rsp)
5 xorl %eax, %eax
6 movq %rdi, 8(%rsp)
7 leaq 8(%rsp), %rsi
8 leaq 16(%rsp), %rdi
9 call iptoa

```

A. For both versions: What are the positions in the stack frame for `buf`, `v`, and (when present) the canary

value?

- B. How does the rearranged ordering of the local variables in the protected code provide greater security against a buffer overrun attack?

## *Limiting Executable Code Regions*

A final step is to eliminate the ability of an attacker to insert executable code into a system. One method is to limit which memory regions hold executable code. In typical programs, only the portion of memory holding the code generated by the compiler need be executable. The other portions can be restricted to allow just reading and writing. As we will see in [Chapter 9](#), the virtual memory space is logically divided into *pages*, typically with 2,048 or 4,096 bytes per page. The hardware supports different forms of *memory protection*, indicating the forms of access allowed by both user programs and the operating system kernel. Many systems allow control over three forms of access: read (reading data from memory), write (storing data into memory), and execute (treating the memory contents as machine-level code). Historically, the x86 architecture merged the read and execute access controls into a single 1-bit flag, so that any page marked as readable was also executable. The stack had to be kept both readable and writable, and therefore the bytes on the stack were also executable. Various schemes were implemented to be able to limit some pages to being readable but not executable, but these generally introduced significant inefficiencies.

More recently, AMD introduced an NX (for "no-execute") bit into the memory protection for its 64-bit processors, separating the read and execute access modes, and Intel followed suit. With this feature, the stack can be marked as being readable and writable, but not executable, and the checking of whether a page is executable is performed in hardware, with no penalty in efficiency.


Some types of programs require the ability to dynamically generate and execute code. For example, "just-in-time" compilation techniques dynamically generate code for programs written in interpreted languages, such as Java, to improve execution performance. Whether or not the run-time system can restrict the executable code to just that part generated by the compiler in creating the original program depends on the language and the operating system.

The techniques we have outlined—randomization, stack protection, and limiting which portions of memory can hold executable code—are three of the most common mechanisms used to minimize the vulnerability of programs to buffer overflow attacks. They all have the properties that they require no special effort on the part of the programmer and incur very little or no performance penalty. Each separately reduces the level of vulnerability, and in combination they become even more effective. Unfortunately, there are still ways to attack computers [85, 97], and so worms and viruses continue to compromise the integrity of many machines.


## 3.10.5 Supporting Variable-Size Stack Frames

We have examined the machine-level code for a variety of functions so far, but they all have the property that the compiler can determine in advance the amount of space that must be allocated for their stack frames. Some functions, however, require a variable amount of local storage. This can occur, for example, when the function calls `alloca`, a standard library function that can allocate an arbitrary number of bytes of storage on the stack. It can also occur when the code declares a local array of variable size.

Although the information presented in this section should rightfully be considered an aspect of how procedures are implemented, we have deferred the presentation to this point, since it requires an understanding of arrays and alignment.

The code of [Figure 3.43\(a\)](#)  gives an example of a function containing a variable-size array. The function declares local array `p` of  $n$  pointers, where  $n$  is given by the first argument. This requires allocating  $8n$  bytes on the stack, where the value of  $n$  may vary from one call of the function to another. The compiler therefore cannot determine how much space it must allocate for the function's stack frame. In addition, the program generates a reference to the address of local variable `i`, and so this variable must also be stored on the stack. During execution, the program must be able to access both

local variable `i` and the elements of array `p`. On returning, the function must deallocate the stack frame and set the stack pointer to the position of the stored return address.

To manage a variable-size stack frame, x86-64 code uses register `%rbp` to serve as a *frame pointer* (sometimes referred to as a *base pointer*, and hence the letters `bp` in `%rbp`). When using a frame pointer, the stack frame is organized as shown for the case of function `vframe` in [Figure 3.44](#) . We see that the code must save the previous version of `%rbp` on the stack, since it is a callee-saved register. It then keeps `%rbp` pointing to this position throughout the execution of the function, and it references fixed-length local variables, such as `i`, at offsets relative to `%rbp`.

(a) C code

```
|  
long vframe(long n, long idx, long *q) {  
    long i;  
    long *p[n];  
    p[0] = &i;  
    for (i = 1; i < n; i++)  
        p[i] = q;  
    return *p[idx];  
}
```

(b) Portions of generated assembly code

```
long vframe(long n, long idx, long *q)
```

```
n in %rdi, idx in %rsi, q in %rdx
```

```
Only portions of code shown
```

```
1  vframe:
2  pushq  %rbp                Save old %rbp
3  movq   %rsp, %rbp          Set frame pointer
4  subq   $16, %rsp           Allocate space for i
                               (%rsp = s1)
5  leaq   22(,%rdi,8), %rax
6  andq   $-16, %rax
7  subq   %rax, %rsp          Allocate space for array
                               p (%rsp = s2)
8  leaq   7(%rsp), %rax
9  shrq   $3, %rax
10 leaq   0(,%rax,8), %r8      Set %r8 to &p[0]
11 movq   %r8, %rcx           Set %rcx to &p[0] (%rcx
                               = p)
...
Code for initialization loop
i in %rax and on stack, n in %rdi, p in %rcx, q in %rdx
12  .L3:                      loop:
13  movq   %rdx, (%rcx,%rax,8) Set p[i] to q
14  addq   $1, %rax           Increment i
15  movq   %rax, -8(%rbp)      Store on stack
16  .L2:
17  movq   -8(%rbp), %rax      Retrieve i from stack
18  cmpq   %rdi, %rax         Compare i:n
```



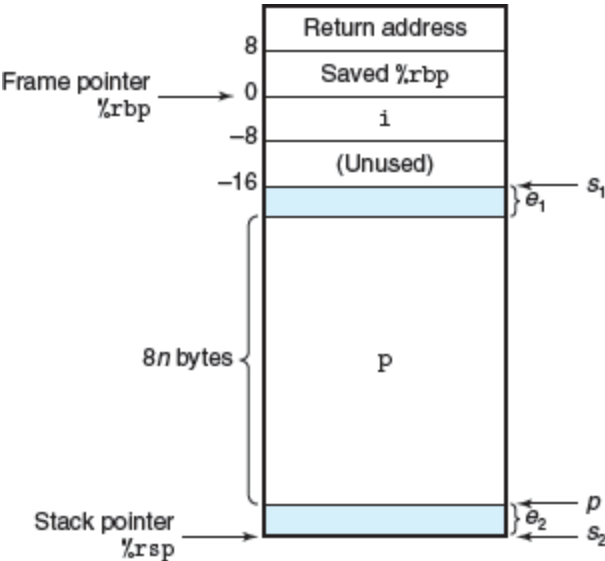
```

19    jl    .L3                If <, goto loop
    ...
    Code for function exit
20    leave                Restore %rbp and %rsp
21    ret                  Return

```

**Figure 3.43** Function requiring the use of a frame pointer.

The variable-size array implies that the size of the stack frame cannot be determined at compile time.



**Figure 3.44** Stack frame structure for function `vframe`.

The function uses register `%rbp` as a frame pointer. The annotations along the right-hand side are in reference to Practice Problem 3.49.

Figure 3.43(b) shows portions of the code GCC generates for function `vframe`. At the beginning of the function, we see code that

sets up the stack frame and allocates space for array `p`. The code starts by pushing the current value of `%rbp` onto the stack and setting `%rbp` to point to this stack position (lines 2–3). Next, it allocates 16 bytes on the stack, the first 8 of which are used to store local variable `i`, and the second 8 of which are unused. Then it allocates space for array `p` (lines 5–11). The details of how much space it allocates and where it positions `p` within this space are explored in Practice [Problem 3.49](#). Suffice it to say that by the time the program reaches line 11, it has (1) allocated at least  $8n$  bytes on the stack and (2) positioned array `p` within the allocated region such that at least  $8n$  bytes are available for its use.

The code for the initialization loop shows examples of how local variables `i` and `p` are referenced. Line 13 shows array element `p[i]` being set to `q`. This instruction uses the value in register `%rcx` as the address for the start of `p`. We can see instances where local variable `i` is updated (line 15) and read (line 17). The address of `i` is given by reference `-8(%rbp)`—that is, at offset -8 relative to the frame pointer.

At the end of the function, the frame pointer is restored to its previous value using the `leave` instruction (line 20). This instruction takes no arguments. It is equivalent to executing the following two instructions:

```
|  
movq %rbp, %rsp      Set stack pointer to beginning of frame  
popq %rbp            Restore saved %rbp and set stack ptr to  
end of caller's frame
```

That is, the stack pointer is first set to the position of the saved value of `%rbp`, and then this value is popped from the stack into `%rbp`. This instruction combination has the effect of deallocating the entire stack frame.

In earlier versions of x86 code, the frame pointer was used with every function call. With x86-64 code, it is used only in cases where the stack frame may be of variable size, as is the case for function `vframe`. Historically, most compilers used frame pointers when generating IA32 code. Recent versions of `gcc` have dropped this convention. Observe that it is acceptable to mix code that uses frame pointers with code that does not, as long as all functions treat `%rbp` as a callee-saved register.

## Practice Problem 3.49 (solution page 347)

In this problem, we will explore the logic behind the code in lines 5–11 of [Figure 3.43\(b\)](#), where space is allocated for variable-size array  $p$ . As the annotations of the code indicate, let us let  $s_1$  denote the address of the stack pointer after executing the `subq` instruction of line 4. This instruction allocates the space for local variable  $i$ . Let  $s_2$  denote the value of the stack pointer after executing the `subq` instruction of line 7. This instruction allocates the storage for local array  $p$ . Finally, let  $p$  denote the value assigned to registers `%r8` and `%rcx` in the instructions of lines 10–11. Both of these registers are used to reference array  $p$ .

The right-hand side of [Figure 3.44](#) diagrams the positions of the locations indicated by  $s_1$ ,  $s_2$ , and  $p$ . It also shows that there may be an offset of  $e_2$  bytes between the values of  $s_1$  and  $p$ . This space will not be used. There may also be an offset of  $e_1$  bytes between the end of array  $p$  and the position indicated by  $s_1$ .

- A. Explain, in mathematical terms, the logic in the computation of  $s_2$  on lines 5–7. *Hint:* Think about the bit-level representation of  $-16$  and its effect in the `andq` instruction of line 6.
- B. Explain, in mathematical terms, the logic in the computation of  $p$  on lines 8–10. *Hint:* You may want to

refer to the discussion on division by powers of 2 in [Section 2.3.7](#).

- C. For the following values of  $n$  and  $s_1$ , trace the execution of the code to determine what the resulting values would be for  $s_2$ ,  $p$ ,  $e_1$ , and  $e_2$ .
- D. What alignment properties does this code guarantee for the values of  $s_2$  and  $p$ ?

[OceanofPDF.com](http://OceanofPDF.com)

## 3.11 Floating-Point Code

The *floating-point architecture* for a processor consists of the different aspects that affect how programs operating on floating-point data are mapped onto the machine, including

- How floating-point values are stored and accessed. This is typically via some form of registers.
- The instructions that operate on floating-point data.
- The conventions used for passing floating-point values as arguments to functions and for returning them as results.
- The conventions for how registers are preserved during function calls—for example, with some registers designated as caller saved, and others as callee saved.

To understand the x86-64 floating-point architecture, it is helpful to have a brief historical perspective. Since the introduction of the Pentium/MMX in 1997, both Intel and AMD have incorporated successive generations of *media* instructions to support graphics and image processing. These instructions originally focused on allowing multiple operations to be performed in a parallel mode known as *single instruction, multiple data*, or *SIMD* (pronounced sim-dee). In this mode the same operation is performed on a number of different data values in parallel. Over the years, there has been a progression of these extensions. The names have changed through a series of major revisions from MMX to SSE (for "streaming SIMD

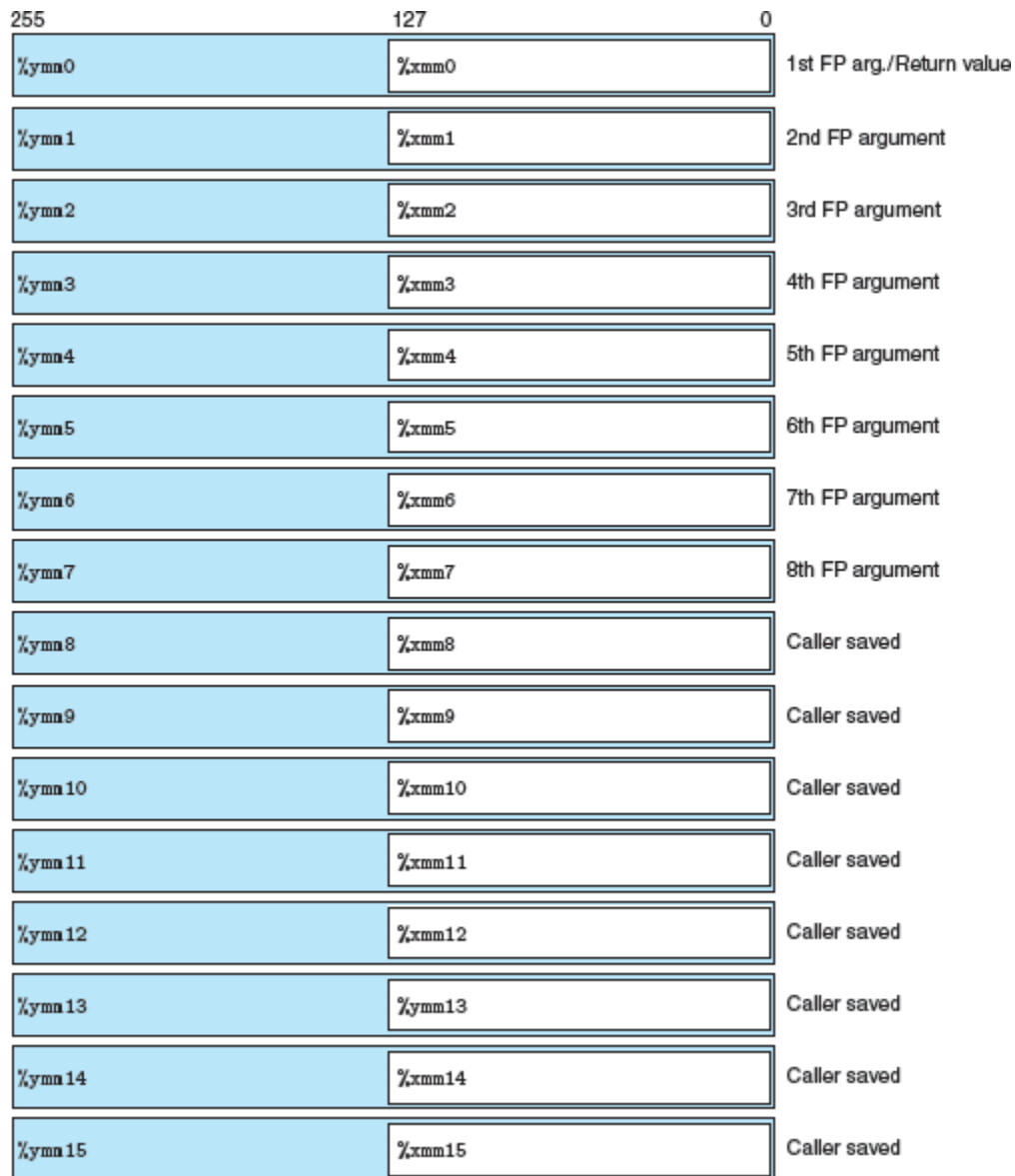
extensions") and most recently AVX (for "advanced vector extensions"). Within each generation, there have also been different versions. Each of these extensions manages data in sets of registers, referred to as "MM" registers for MMX, "XMM" for SSE, and "YMM" for AVX, ranging from 64 bits for MM registers, to 128 for XMM, to 256 for YMM. So, for example, each YMM register can hold eight 32-bit values, or four 64-bit values, where these values can be either integer or floating point.

Starting with SSE2, introduced with the Pentium 4 in 2000, the media instructions have included ones to operate on *scalar* floating-point data, using single values in the low-order 32 or 64 bits of XMM or YMM registers. This scalar mode provides a set of registers and instructions that are more typical of the way other processors support floating point. All processors capable of executing x86-64 code support SSE2 or higher, and hence x86-64 floating point is based on SSE or AVX, including conventions for passing procedure arguments and return values [77].

Our presentation is based on AVX2, the second version of AVX, introduced with the Core i7 Haswell processor in 2013. GCC will generate AVX2 code when given the command-line parameter `-mavx2`. Code based on the different versions of SSE, as well as the first version of AVX, is conceptually similar, although they differ in the instruction names and formats. We present only instructions that arise in compiling floating-point programs with GCC. These are, for the most part, the scalar AVX instructions, although we document occasions where instructions intended for operating on entire data

vectors arise. A more complete coverage of how to exploit the SIMD capabilities of SSE and AVX is presented in Web Aside `OPT:SIMD` on page 546. Readers may wish to refer to the AMD and Intel documentation for the individual instructions [\[4, 51\]](#). As with integer operations, note that the ATT format we use in our presentation differs from the Intel format used in these documents. In particular, the instruction operands are listed in a different order in these two versions.





**Figure 3.45 Media registers.**

These registers are used to hold floating-point data. Each YMM register holds 32 bytes. The low-order 16 bytes can be accessed as an XMM register.


As is illustrated in [Figure 3.45](#), the AVX floating-point architecture allows data to be stored in 16 YMM registers, named `%ymm0-%ymm15`. Each YMM register is 256 bits (32 bytes) long. When operating on

scalar data, these registers only hold floating-point data, and only the low-order 32 bits (for float) or 64 bits (for double) are used. The assembly code refers to the registers by their SSE XMM register names `%xmm0-%xmm15`, where each XMM register is the low-order 128 bits (16 bytes) of the corresponding YMM register.

**Figure 3.46 Floating-point movement instructions.**

These operations transfer values between memory and registers, as well as between pairs of registers. (X: XMM register (e.g., `%xmm3`);  $M_{32}$ : 32-bit memory range;  $M_{64}$ : 64-bit memory range)

## 3.11.1 Floating-Point Movement and Conversion Operations

**Figure 3.46**  shows a set of instructions for transferring floating-point data between memory and XMM registers, as well as from one XMM register to another without any conversions. Those that reference memory are *scalar* instructions, meaning that they operate on individual, rather than packed, data values. The data are held either in memory (indicated in the table as  $M_{32}$  and  $M_{64}$ ) or in XMM registers (shown in the table as  $X$ ). These instructions will work correctly regardless of the alignment of data, although the code optimization guidelines recommend that 32-bit memory data satisfy a 4-byte alignment and that 64-bit data satisfy an 8-byte alignment. Memory references are specified in the same way as for the integer `mov` instructions, with all of the different possible combinations of displacement, base register, index register, and scaling factor.

Gcc uses the scalar movement operations only to transfer data from memory to an XMM register or from an XMM register to memory. For transferring data between two XMM registers, it uses one of two different instructions for copying the entire contents of one XMM register to another—namely, `vmovaps` for single-precision and `vmovapd` for double-precision values. For these cases, whether the program copies the entire register or just the low-order value affects neither the program functionality nor the execution speed, and so using these instructions rather than ones specific to scalar data

makes no real difference. The letter ``a'` in these instruction names stands for "aligned." When used to read and write memory, they will cause an exception if the address does not satisfy a 16-byte alignment. For transferring between two registers, there is no possibility of an incorrect alignment.

As an example of the different floating-point move operations, consider the C function

```
float float_mov(float v1, float *src, float *dst) {  
    float v2 = *src;  
    *dst = v1;  
    return v2;  
}
```

**Figure 3.47 Two-operand floating-point conversion operations.** These convert floating-point data to integers. (X: XMM register (e.g., `%xmm3`);  $R_{32}$ : 32-bit general-purpose register (e.g., `%eax`);  $R_{64}$ : 64-bit general-purpose register (e.g., `%rax`);  $M_{32}$ : 32-bit memory range;  $M_{64}$ : 64-bit memory range)

**Figure 3.48 Three-operand floating-point conversion operations.** These instructions convert from the data type of the first source to the data type of the destination. The second source value has no effect on the low-order bytes of the result. (X: XMM register (e.g., `%xmm3`);  $M_{32}$ : 32-bit memory range;  $M_{64}$ : 64-bit memory range)

and its associated x86-64 assembly code

```
|
|
|     float float_mov(float v1, float *src, float *dst)
|     v1 in %xmm0, src in %rdi, dst in %rsi
1     float_mov:
2     vmovaps %xmm0, %xmm1    Copy v1
3     vmovss  (%rdi), %xmm0   Read v2 from src
4     vmovss  %xmm1, (%rsi)   Write v1 to dst
5     ret                    Return v2 in %xmm0
```

We can see in this example the use of the `vmovaps` instruction to copy data from one register to another and the use of the `vmovss`

instruction to copy data from memory to an XMM register and from an XMM register to memory.

**Figures 3.47** and **3.48** show sets of instructions for converting between floating-point and integer data types, as well as between different floating-point formats. These are all scalar instructions operating on individual data values. Those in **Figure 3.47** convert from a floating-point value read from either an XMM register or memory and write the result to a general-purpose register (e.g., `%rax`, `%ebx`, etc.). When converting floating-point values to integers, they perform *truncation*, rounding values toward zero, as is required by C and most other programming languages.

The instructions in **Figure 3.48** convert from integer to floating point. They use an unusual three-operand format, with two sources and a destination. The first operand is read from memory or from a general-purpose register. For our purposes, we can ignore the second operand, since its value only affects the upper bytes of the result. The destination must be an XMM register. In common usage, both the second source and the destination operands are identical, as in the instruction

```
vcvttsi2sdq    %rax, %xmm1, %xmm1
```

This instruction reads a long integer from register `%rax`, converts it to data type double, and stores the result in the lower bytes of XMM

register `%xmm1`.

Finally, for converting between two different floating-point formats, current versions of `gcc` generate code that requires separate documentation. Suppose the low-order 4 bytes of `%xmm0` hold a single-precision value; then it would seem straightforward to use the instruction

```
vcvts2sd    %xmm0, %xmm0, %xmm0
```

to convert this to a double-precision value and store the result in the lower 8 bytes of register `%xmm0`. Instead, we find the following code generated by `gcc`:

```
          Conversion from single to double precision  
1      vunpcklps    %xmm0, %xmm0, %xmm0    Replicate first  
vector element  
2      vcvtps2pd    %xmm0, %xmm0          Convert two  
vector elements to double
```

The `vunpcklps` instruction is normally used to interleave the values in two XMM registers and store them in a third. That is, if one source register contains words  $[s_3, s_2, s_1, s_0]$  and the other contains words

$[d_3, d_2, d_1, d_0]$ , then the value of the destination register will be  $[s_1, d_1, s_0, d_0]$ . In the code above, we see the same register being used for all three operands, and so if the original register held values  $[x_3, x_2, x_1, x_0]$ , then the instruction will update the register to hold values  $[x_1, x_1, x_0, x_0]$ . The `vcvtps2pd` instruction expands the two low-order single-precision values in the source XMM register to be the two double-precision values in the destination XMM register. Applying this to the result of the preceding `vunpcklps` instruction would give values  $[dx_0, dx_0]$ , where  $dx_0$  is the result of converting  $x$  to double precision. That is, the net effect of the two instructions is to convert the original single-precision value in the low-order 4 bytes of `%xmm0` to double precision and store two copies of it in `%xmm0`. It is unclear why gcc generates this code. There is neither benefit nor need to have the value duplicated within the XMM register.

Gcc generates similar code for converting from double precision to single precision:

```
|  
Conversion from double to single precision  
1      vmovddup      %xmm0, %xmm0      Replicate first vector  
element  
2      vcvtpd2psx   %xmm0, %xmm0      Convert two vector  
elements to single
```



Suppose these instructions start with register `%xmm0` holding two double-precision values  $[x_1, x_0]$ . Then the `vmovddup` instruction will set it to  $[x_0, x_0]$ . The `vcvtpd2psx` instruction will convert these values to single precision, pack them into the low-order half of the register, and set the upper half to 0, yielding a result  $[0.0, 0.0, x_0, x_0]$  (recall that floating-point value 0.0 is represented by a bit pattern of all zeros). Again, there is no clear value in computing the conversion from one precision to another this way, rather than by using the single instruction

```
|  
vcvtsd2ss %xmm0, %xmm0, %xmm0
```

As an example of the different floating-point conversion operations, consider the C function

```
|  
double fcvt(int i, float *fp, double *dp, long *lp)  
{  
    float f = *fp; double d = *dp; long l = *lp;  
    *lp = (long) d;  
    *fp = (float) i;  
    *dp = (double) l;  
    return (double) f;  
}
```

and its associated x86-64 assembly code

```
|
|
|   double fcvt(int i, float *fp, double *dp, long *lp)
|   i in %edi, fp in %rsi, dp in %rdx, lp in %rcx
1   fcvt:
2   vmovss (%rsi), %xmm0           Get f = *fp
3   movq   (%rcx), %rax           Get l = *lp
4   vcvttsd2siq (%rdx), %r8       Get d = *dp and
|   convert to long
5   movq   %r8, (%rcx)           Store at lp
6   vcvtsi2ss %edi, %xmm1, %xmm1  Convert i to
|   float
7   vmovss %xmm1, (%rsi)         Store at fp
8   vcvtsi2sdq %rax, %xmm1, %xmm1 Convert l to
|   double
9   vmovsd %xmm1, (%rdx)         Store at dp
|   The following two instructions convert f to double
10  vunpcklps %xmm0, %xmm0, %xmm0
11  vcvtps2pd %xmm0, %xmm0
12  ret                           Return f
```

All of the arguments to `fcvt` are passed through the general-purpose registers, since they are either integers or pointers. The result is returned in register `%xmm0`. As is documented in [Figure 3.45](#), this is the designated return register for float or double values. In this code, we see a number of the movement and conversion instructions

of [Figures 3.46](#)–[3.48](#), as well as `gcc`'s preferred method of converting from single to double precision.

## Practice Problem 3.50 (solution page 347)

For the following C code, the expressions `val1-val4` all map to the program values `i`, `f`, `d`, and `l`:

```
|  
double fcvt2(int *ip, float *fp, double *dp, long l)  
{  
    int i = *ip; float f = *fp; double d = *dp;  
    *ip = (int)    val1;  
    *fp = (float)  val2;  
    *dp = (double) val3;  
    return (double) val4;  
}
```

Determine the mapping, based on the following x86-64 code for the function:

```
double fcvt2(int *ip, float *fp, double *dp, long  
1) ip in %rdi, fp in %rsi, dp in %rdx, l in %rcx Result  
returned in %xmm0
```

```
1 fcvt2:  
2 movl (%rdi), %eax  
3 vmovss (%rsi), %xmm0  
4 vcvttss2si (%rdx), %r8d  
5 movl %r8d, (%rdi)  
6 vcvtsi2ss %eax, %xmm1, %xmm1  
7 vmovss %xmm1, (%rsi)  
8 vcvtsi2sdq %rcx, %xmm1, %xmm1  
9 vmovsd %xmm1, (%rdx)  
10 vunpcklps %xmm0, %xmm0, %xmm0  
11 vcvtps2pd %xmm0, %xmm0  
12 ret
```

## Practice Problem 3.51 (solution page 348)

The following C function converts an argument of type `src_t` to a return value of type `dst_t`, where these two types are defined using `typedef`:

```
|
|
| dest_t cvt(src_t x)
| {
|     dest_t y = (dest_t) x;
|     return y;
| }
```

For execution on x86-64, assume that argument `x` is either in `%xmm0` or in the appropriately named portion of register `%rdi` (i.e., `%rdi` or `%edi`). One or two instructions are to be used to perform the type conversion and to copy the value to the appropriately named portion of register `%rax` (integer result) or `%xmm0` (floating-point result). Show the instruction(s), including the source and destination registers.

## 3.11.2 Floating-Point Code in Procedures

With x86-64, the XMM registers are used for passing floating-point arguments to functions and for returning floating-point values from them. As is illustrated in [Figure 3.45](#), the following conventions are observed:

- Up to eight floating-point arguments can be passed in XMM registers `%xmm0-%xmm7`. These registers are used in the order the arguments are listed. Additional floating-point arguments can be passed on the stack.
- A function that returns a floating-point value does so in register `%xmm0`.
- All XMM registers are caller saved. The callee may overwrite any of these registers without first saving it.

When a function contains a combination of pointer, integer, and floating-point arguments, the pointers and integers are passed in general-purpose registers, while the floating-point values are passed in XMM registers. This means that the mapping of arguments to registers depends on both their types and their ordering. Here are several examples:

```
|  
double f1(int x, double y, long z);
```

This function would have `x` in `%edi`, `y` in `%xmm0`, and `z` in `%rsi`.

```
|  
double f2(double y, int x, long z);
```

This function would have the same register assignment as function `f1`.

```
|  
double f1(float x, double *y, long *z);
```

This function would have `x` in `%xmm0`, `y` in `%rdi`, and `z` in `%rsi`.




## *Practice Problem 3.52 (solution page 348)*

For each of the following function declarations, determine the register assignments for the arguments:

- A. `double g1(double a, long b, float c, int d);`
- B. `double g2(int a, double *b, float *c, long d);`
- C. `double g3(double *a, double b, int c, float d);`
- D. `double g4(float a, int *b, float c, double d);`

## 3.11.3 Floating-Point Arithmetic Operations

**Figure 3.49**  documents a set of scalar AVX2 floating-point instructions that perform arithmetic operations. Each has either one ( $S_1$ ) or two ( $S_1, S_2$ ) source operands and a destination operand  $D$ . The first source operand  $S_1$  can be either an XMM register or a memory location. The second source operand and the destination operands must be XMM registers. Each operation has an instruction for single precision and an instruction for double precision. The result is stored in the destination register.

As an example, consider the following floating-point function:

```
|  
double funct(double a, float x, double b, int i)  
{  
    return a*x - b/i;  
}
```

The x86-64 code is as follows:

```

|
|
|   double funct(double a, float x, double b, int i)
|   a in %xmm0, x in %xmm1, b in %xmm2, i in %edi
1   funct:
|   The following two instructions convert x to double
2   vunpcklps    %xmm1, %xmm1, %xmm1
3   vcvtps2pd    %xmm1, %xmm1
4   vmulsd      %xmm0, %xmm1, %xmm0    Multiply a by x
5   vcvtsi2sd    %edi, %xmm1, %xmm1    Convert i to
double
6   vdivsd      %xmm1, %xmm2, %xmm2    Compute b/i

```

### Figure 3.49 Scalar floating-point arithmetic operations.

These have either one or two source operands and a destination operand.

```

|
|
7   vsubsd      %xmm2, %xmm0, %xmm0    Subtract from a*x
8   ret
|   Return

```

The three floating-point arguments `a`, `x`, and `b` are passed in XMM registers `%xmm0-%xmm2`, while integer argument `i` is passed in register `%edi`. The standard two-instruction sequence is used to convert argument `x` to double (lines 2-3). Another conversion instruction is

required to convert argument `i` to double (line 5). The function value is returned in register `%xmm0`.

## Practice Problem 3.53 (solution page 348)

For the following C function, the types of the four arguments are defined by `typedef`:

```
|  
double funct1(arg1_t p, arg2_t q, arg3_t r, arg4_t s)  
{  
    return p/(q+r) - s;  
}
```

When compiled, gcc generates the following code:

```
|  
    double funct1(arg1_t p, arg2_t q, arg3_t r,  
arg4_t s)  
1    funct1:  
2    vcvtsi2ssq    %rsi, %xmm2, %xmm2  
3    vaddss       %xmm0, %xmm2, %xmm0  
4    vcvtsi2ss    %edi, %xmm2, %xmm2  
5    vdivss       %xmm0, %xmm2, %xmm0  
6    vunpcklps    %xmm0, %xmm0, %xmm0  
7    vcvtps2pd    %xmm0, %xmm0  
8    vsubsd       %xmm1, %xmm0, %xmm0  
9    ret
```

Determine the possible combinations of types of the four arguments (there may be more than one).

## Practice Problem 3.54 (solution page 349)

Function `funct2` has the following prototype:

```
double funct2(double w, int x, float y, long z);
```

Gcc generates the following code for the function:

```
double funct2(double w, int x, float y, long z) w
in %xmm0, x in %edi, y in %xmm1, z in %rsi
1 funct2:
2 vcvtsi2ss %edi, %xmm2, %xmm2
3 vmulss %xmm1, %xmm2, %xmm1
4 vunpcklps %xmm1, %xmm1, %xmm1
5 vcvtps2pd %xmm1, %xmm2
6 vcvtsi2sdq %rsi, %xmm1, %xmm1
7 vdivsd %xmm1, %xmm0, %xmm0
8 vsubsd %xmm0, %xmm2, %xmm0
9 ret
```

Write a C version of `funct2`.

## 3.11.4 Defining and Using Floating-Point Constants

Unlike integer arithmetic operations, AVX floating-point operations cannot have immediate values as operands. Instead, the compiler must allocate and initialize storage for any constant values. The code then reads the values from memory. This is illustrated by the following Celsius to Fahrenheit conversion function:

```
|  
double cel2fahr(double temp)  
{  
    return 1.8 * temp + 32.0;  
}
```

The relevant parts of the x86-64 assembly code are as follows:

```

|
|   double cel2fahr(double temp) temp in %xmm0
1   cel2fahr:
2   vmulsd    .LC2(%rip), %xmm0, %xmm0    Multiply
|   by 1.8
3   vaddsd    .LC3(%rip), %xmm0, %xmm0    Add 32.0
4   ret
5   .LC2:
6   .long 3435973837    Low-
|   order 4 bytes of 1.8
7   .long 1073532108    High-
|   order 4 bytes of 1.8
8   .LC3:
9   .long 0    Low-
|   order 4 bytes of 32.0
10  .long 1077936128    High-
|   order 4 bytes of 32.0

```

We see that the function reads the value 1.8 from the memory location labeled `.LC2` and the value 32.0 from the memory location labeled `.LC3`. Looking at the values associated with these labels, we see that each is specified by a pair of `.long` declarations with the values given in decimal. How should these be interpreted as floating-point values? Looking at the declaration labeled `.LC2`, we see that the two values are 3435973837 (`0xcccccccd`) and 1073532108 (`0x3ffcccc.`). Since the machine uses little-endian byte ordering, the



first value gives the low-order 4 bytes, while the second gives the high-order 4 bytes. From the high-order bytes, we can extract an exponent field of `0x3ff` (1023), from which we subtract a bias of 1023 to get an exponent of 0. Concatenating the fraction bits of the two values, we get a fraction field of `0xccccccccccd`, which can be shown to be the fractional binary representation of 0.8, to which we add the implied leading one to get 1.8.

**Figure 3.50 Bitwise operations on packed data.**

These instructions perform Boolean operations on all 128 bits in an XMM register.

*Practice Problem 3.55 (solution page **349**)*

Show how the numbers declared at label `.LC3` encode the number 32.0.

## 3.11.5 Using Bitwise Operations in Floating-Point Code

At times, we find `gcc` generating code that performs bitwise operations on XMM registers to implement useful floating-point results. [Figure 3.50](#) shows some relevant instructions, similar to their counterparts for operating on general-purpose registers. These operations all act on packed data, meaning that they update the entire destination XMM register, applying the bitwise operation to all the data in the two source registers. Once again, our only interest for scalar data is the effect these instructions have on the low-order 4 or 8 bytes of the destination. These operations are often simple and convenient ways to manipulate floating-point values, as is explored in the following problem.

## Practice Problem 3.56 (solution page 350)

Consider the following C function, where `EXPR` is a macro defined with `#define`:

```
|  
double simplefun(double x)  
{  
    return EXPR(x);  
}
```

Below, we show the AVX2 code generated for different definitions of `EXPR`, where value `x` is held in `%xmm0`. All of them correspond to some useful operation on floating-point values. Identify what the operations are. Your answers will require you to understand the bit patterns of the constant words being retrieved from memory.

A.

```
|  
1      vmovsd      .LC1(%rip), %xmm1  
2      vandpd     %xmm1, %xmm0, %xmm0  
3      .LC1:  
4      .long      4294967295  
5      .long      2147483647  
6      .long      0  
7      .long      0
```

B.

```
|  
1      vxorpd     %xmm0, %xmm0, %xmm0
```

C.

```
|  
1      vmovsd     .LC2(%rip), %xmm1  
2      vxorpd     %xmm1, %xmm0, %xmm0  
3      .LC2:  
4      .long      0  
5      .long      -2147483648  
6      .long      0  
7      .long      0
```

## 3.11.6 Floating-Point Comparison Operations

AVX2 provides two instructions for comparing floating-point values:

These instructions are similar to the `CMP` instructions (see [Section 3.6](#)), in that they compare operands  $S_1$  and  $S_2$  (but in the opposite order one might expect) and set the condition codes to indicate their relative values. As with `cmpq`, they follow the ATT-format convention of listing the operands in reverse order. Argument  $S_2$  must be in an XMM register, while  $S_1$  can be either in an XMM register or in memory.

The floating-point comparison instructions set three condition codes: the zero flag `ZF`, the carry flag `CF`, and the parity flag `PF`. We did not document the parity flag in [Section 3.6.1](#), because it is not commonly found in GCC-generated x86 code. For integer operations, this flag is set when the most recent arithmetic or logical operation yielded a value where the least significant byte has even parity (i.e., an even number of ones in the byte). For floating-point comparisons, however, the flag is set when either operand is *NaN*. By convention, any comparison in C is considered to fail when one of the arguments is *NaN*, and this flag is used to detect such a condition. For example, even the comparison `x == x` yields 0 when `x` is *NaN*.

The condition codes are set as follows:

The *unordered* case occurs when either operand is *NaN*. This can be detected with the parity flag. Commonly, the `jp` (for "jump on parity") instruction is used to conditionally jump when a floating-point comparison yields an unordered result. Except for this case, the values of the carry and zero flags are the same as those for an unsigned comparison: `ZF` is set when the two operands are equal, and `CF` is

(a) C code

```
|  
typedef enum {NEG, ZERO, POS, OTHER} range_t;  
  
range_t find_range(float x)  
{  
    int result;  
    if (x < 0)  
        result = NEG;  
    else if (x == 0)  
        result = ZERO;  
    else if (x > 0)  
        result = POS;  
    else  
        result = OTHER;  
    return result;  
}
```

(b) Generated assembly code

```

|
|   range_t find_range(float x) x in %xmm0
1   find_range:
2   vxorps    %xmm1, %xmm1, %xmm1      Set
|xmm1 = 0
3   vucomiss  %xmm0, %xmm1            Compare
0:x
4   ja       .L5                      If >,
goto neg
5   vucomiss  %xmm1, %xmm0            Compare
x:0
6   jp       .L8                      If NaN,
goto posornan
7   movl     $1, %eax                 result =
ZERO
8   je       .L3                      If =,
goto done
9   .L8:                                posornan:
10  vucomiss  .LC0(%rip), %xmm0       Compare
x:0
11  setbe    %al                      Set
result = NaN ? 1 : 0
12  movzbl   %al, %eax                Zero-
extend
13  addl     $2, %eax                 result
+= 2 (POS for > 0, OTHER for NaN)
14  ret                                           Return
15  .L5:                                neg:

```



```

16      movl  $0, %eax      result =
NEG
17      .L3:                done:
18      rep; ret           Return

```

**Figure 3.51** Illustration of conditional branching in floating-point code.

set when  $S_2 < S_1$ . Instructions such as `ja` and `jb` are used to conditionally jump on various combinations of these flags.

As an example of floating-point comparisons, the C function of **Figure 3.51(a)** classifies argument `x` according to its relation to 0.0, returning an enumerated type as the result. Enumerated types in C are encoded as integers, and so the possible function values are: `0 (NEG)`, `1 (ZERO)`, `2 (POS)`, and `3 (OTHER)`. This final outcome occurs when the value of `x` is *NaN*.

Gcc generates the code shown in **Figure 3.51(b)** for `find_range`. The code is not very efficient—it compares `x` to 0.0 three times, even though the required information could be obtained with a single comparison. It also generates floating point constant 0.0 twice—once using `vxorps`, and once by reading the value from memory. Let us trace the flow of the function for the four possible comparison results:

$x < 0.0$  The `ja` branch on line 4 will be taken, jumping to the end with a return value of 0.

$x = 0.0$  The `ja` (line 4) and `jp` (line 6) branches will not be taken, but the `je` branch (line 8) will, returning with `%eax` equal to 1.

$x > 0.0$  None of the three branches will be taken. The `setb` (line 11) will yield 0, and this will be incremented by the `addl` instruction (line 13) to give a return value of 2.

$x = NaN$  The `jp` branch (line 6) will be taken. The third `vucomiss` instruction (line 10) will set both the carry and the zero flag, and so the `setb` instruction (line 11) and the following instruction will set `%eax` to 1. This gets incremented by the `addl` instruction (line 13) to give a return value of 3.

In Homework [Problems 3.73](#) and [3.74](#), you are challenged to hand-generate more efficient implementations of `find_range`.

## *Practice Problem 3.57 (solution page 350)*

Function `funct3` has the following prototype:

```
double funct3(int *ap, double b, long c, float *dp);
```

For this function, gcc generates the following code:

```

|
|
|      double funct3(int *ap, double b, long c, float
|      *dp)
|
|      ap in %rdi, b in %xmm0, c in %rsi, dp in %rdx
1      funct3:
2          vmovss        (%rdx), %xmm1
3          vcvtsi2sd     (%rdi), %xmm2, %xmm2
4          vucomisd     %xmm2, %xmm0
5          jbe    .L8
6          vcvtsi2ssq   %rsi, %xmm0, %xmm0
7          vmulss       %xmm1, %xmm0, %xmm1
8          vunpcklps   %xmm1, %xmm1, %xmm1
9          vcvtps2pd   %xmm1, %xmm0
10         ret
11     .L8:
12         vaddss      %xmm1, %xmm1, %xmm1
13         vcvtsi2ssq   %rsi, %xmm0, %xmm0
14         vaddss      %xmm1, %xmm0, %xmm0
15         vunpcklps   %xmm0, %xmm0, %xmm0
16         vcvtps2pd   %xmm0, %xmm0
17         ret

```

Write a C version of `funct3`.

## 3.11.7 Observations about Floating-Point Code

We see that the general style of machine code generated for operating on floating-point data with AVX2 is similar to what we have seen for operating on integer data. Both use a collection of registers to hold and operate on values, and they use these registers for passing function arguments.

Of course, there are many complexities in dealing with the different data types and the rules for evaluating expressions containing a mixture of data types, and AVX2 code involves many more different instructions and formats than is usually seen with functions that perform only integer arithmetic.

AVX2 also has the potential to make computations run faster by performing parallel operations on packed data. Compiler developers are working on automating the conversion of scalar code to parallel code, but currently the most reliable way to achieve higher performance through parallelism is to use the extensions to the C language supported by `gcc` for manipulating vectors of data. See Web Aside `OPT:SIMD` on page 546 to see how this can be done.

## 3.12 Summary

In this chapter, we have peered beneath the layer of abstraction provided by the C language to get a view of machine-level programming. By having the compiler generate an assembly-code representation of the machine-level program, we gain insights into both the compiler and its optimization capabilities, along with the machine, its data types, and its instruction set. In [Chapter 5](#), we will see that knowing the characteristics of a compiler can help when trying to write programs that have efficient mappings onto the machine. We have also gotten amore complete picture of how the program stores data in different memory regions. In [Chapter 12](#), we will see many examples where application programmers need to know whether a program variable is on the run-time stack, in some dynamically allocated data structure, or part of the global program data. Understanding how programs map onto machines makes it easier to understand the differences between these kinds of storage.

Machine-level programs, and their representation by assembly code, differ in many ways from C programs. There is minimal distinction between different data types. The program is expressed as a sequence of instructions, each of which performs a single operation. Parts of the program state, such as registers and the run-time stack, are directly visible to the programmer. Only low-level operations are provided to support data manipulation and program control. The compiler must use multiple instructions to generate and operate on

different data structures and to implement control constructs such as conditionals, loops, and procedures. We have covered many different aspects of C and how it gets compiled. We have seen that the lack of bounds checking in C makes many programs prone to buffer overflows. This has made many systems vulnerable to attacks by malicious intruders, although recent safeguards provided by the run-time system and the compiler help make programs more secure.

We have only examined the mapping of C onto x86-64, but much of what we have covered is handled in a similar way for other combinations of language and machine. For example, compiling C++ is very similar to compiling C. In fact, early implementations of C++ first performed a source-to-source conversion from C++ to C and generated object code by running a C compiler on the result. C++ objects are represented by structures, similar to a C `struct`.

Methods are represented by pointers to the code implementing the methods. By contrast, Java is implemented in an entirely different fashion. The object code of Java is a special binary representation known as *Java byte code*. This code can be viewed as a machine-level program for a *virtual machine*. As its name suggests, this machine is not implemented directly in hardware. Instead, software interpreters process the byte code, simulating the behavior of the virtual machine. Alternatively, an approach known as *just-in-time compilation* dynamically translates byte code sequences into machine instructions. This approach provides faster execution when code is executed multiple times, such as in loops. The advantage of using byte code as the low-level representation of a program is that the same code can be "executed" on many different machines,

whereas the machine code we have considered runs only on x86-64 machines.

[OceanofPDF.com](http://OceanofPDF.com)



# Bibliographic Notes

Both Intel and AMD provide extensive documentation on their processors. This includes general descriptions of an assembly-language programmer's view of the hardware [2, 50], as well as detailed references about the individual instructions [3, 51]. Reading the instruction descriptions is complicated by the facts that (1) all documentation is based on the Intel assembly-code format, (2) there are many variations for each instruction due to the different addressing and execution modes, and (3) there are no illustrative examples. Still, these remain the authoritative references about the behavior of each instruction.

The organization x86-64.org has been responsible for defining the *application binary interface* (ABI) for x86-64 code running on Linux systems [77]. This interface describes details for procedure linkages, binary code files, and a number of other features that are required for machine-code programs to execute properly.

As we have discussed, the ATT format used by `gcc` is very different from the Intel format used in Intel documentation and by other compilers (including the Microsoft compilers).

Muchnick's book on compiler design [80] is considered the most comprehensive reference on code-optimization techniques. It covers

many of the techniques we discuss here, such as register usage conventions.

Much has been written about the use of buffer overflow to attack systems over the Internet. Detailed analyses of the 1988 Internet worm have been published by Spafford [105] as well as by members of the team at MIT who helped stop its spread [35]. Since then a number of papers and projects have generated ways both to create and to prevent buffer overflow attacks. Seacord's book [97] provides a wealth of information about buffer overflow and other attacks on code generated by C compilers.

[OceanofPDF.com](http://OceanofPDF.com)

# Homework Problems

## 3.58

For a function with prototype

```
long decode2(long x, long y, long z);
```

gcc generates the following assembly code:

```
1      decode2:  
2      subq   %rdx, %rsi  
3      imulq  %rsi, %rdi  
4      movq   %rsi, %rax  
5      salq   $63, %rax  
6      sarq   $63, %rax  
7      xorq   %rdi, %rax  
8      ret
```

Parameters `x`, `y`, and `z` are passed in registers `%rdi`, `%rsi`, and `%rdx`. The code stores the return value in register `%rax`.

Write C code for `decode2` that will have an effect equivalent to the assembly code shown.

## 3.59

The following code computes the 128-bit product of two 64-bit signed values  $x$  and  $y$  and stores the result in memory:

```
|  
1     typedef __int128 int128_t;  
2  
3     void store_prod(int128_t *dest, int64_t x,  
int64_t y) {  
4     *dest = x * (int128_t) y;  
5     }
```

Gcc generates the following assembly code implementing the computation:

```

|
1   store_prod:
2   movq   %rdx, %rax
3   cqto
4   movq   %rsi, %rcx
5   sarq   $63, %rcx
6   imulq %rax, %rcx
7   imulq %rsi, %rdx
8   addq   %rdx, %rcx
9   mulq   %rsi
1   addq   %rcx, %rdx
1   movq   %rax, (%rdi)
1   movq   %rdx, 8(%rdi)
1   ret

```

This code uses three multiplications for the multiprecision arithmetic required to implement 128-bit arithmetic on a 64-bit machine. Describe the algorithm used to compute the product, and annotate the assembly code to show how it realizes your algorithm. *Hint:* When extending arguments of  $x$  and  $y$  to 128 bits, they can be rewritten as  $x = 2^{64} \cdot x_h + x_l$  and  $y = 2^{64} \cdot y_h + y_l$ , where  $x_h$ ,  $x_l$ ,  $y_h$ , and  $y_l$  are 64-bit values. Similarly, the 128-bit product can be written as  $p = 2^{64} \cdot p_h + p_l$ , where  $p_h$  and  $p_l$  are 64-bit values. Show how the code computes the values of  $p_h$  and  $p_l$  in terms of  $x_h$ ,  $x_l$ ,  $y_h$ , and  $y_l$ .

## 3.60

Consider the following assembly code:

```
|  
    long loop(long x, int n)  
    x in %rdi, n in %esi  
1    loop:  
2    movl %esi, %ecx  
3    movl $1, %edx  
4    movl $0, %eax  
5    jmp  .L2  
6    .L3:  
7    movq %rdi, %r8  
8    andq %rdx, %r8  
9    orq  %r8, %rax  
10   salq %cl, %rdx  
11   .L2:  
12   testq %rdx, %rdx  
13   jne  .L3  
14   rep; ret
```

The preceding code was generated by compiling C code that had the following overall form:

```

1     long loop(long x, long n)
2     {
3         long result = ____;
4         long mask;
5         for (mask = ____; mask ____; mask =
____){
6             result | ____ = ____;
7         }
8     return result;
9     }

```

Your task is to fill in the missing parts of the C code to get a program equivalent to the generated assembly code. Recall that the result of the function is returned in register `%rax`. You will find it helpful to examine the assembly code before, during, and after the loop to form a consistent mapping between the registers and the program variables.

- A. Which registers hold program values `x`, `n`, `result`, and `mask`?
- B. What are the initial values of `result` and `mask`?
- C. What is the test condition for `mask`?
- D. How does `mask` get updated?
- E. How does `result` get updated?
- F. Fill in all the missing parts of the C code.



## 3.61

In [Section 3.6.6](#), we examined the following code as a candidate for the use of conditional data transfer:

```
|  
long cread(long *xp) {  
    return (xp ? *xp : 0);  
}
```

We showed a trial implementation using a conditional move instruction but argued that it was not valid, since it could attempt to read from a null address.

Write a C function `cread_alt` that has the same behavior as `cread`, except that it can be compiled to use conditional data transfer. When compiled, the generated code should use a conditional move instruction rather than one of the jump instructions.

## 3.62

The code that follows shows an example of branching on an enumerated type value in a switch statement. Recall that enumerated types in C are simply a way to introduce a set of names having associated integer values. By default, the values assigned to the names count from zero upward. In our code, the actions associated with the different case labels have been omitted.

```

1      /* Enumerated type creates set of constants
   numbered 0 and upward */
2      typedef enum {MODE_A, MODE_B, MODE_C, MODE_D,
MODE_E} mode_t;
3
4      long switch3(long *p1, long *p2, mode_t action)
5      {
6          long result = 0;
7          switch(action) {
8              case MODE_A: 9
10             case MODE_B:
11
12             case MODE_C:
13
14             case MODE_D:
15
16             case MODE_E:
17
18             default:
19
20             }
21             return result;
22     }

```

The part of the generated assembly code implementing the different actions is shown in [Figure 3.52](#). The annotations

indicate the argument locations, the register values, and the case labels for the different jump destinations.

Fill in the missing parts of the C code. It contained one case that fell through to another—try to reconstruct this.

## 3.63

This problem will give you a chance to reverse engineer a `switch` statement from disassembled machine code. In the following procedure, the body of the `switch` statement has been omitted:

```
|
1     long switch_prob(long x, long n) {
2         long result = x;
3         switch(n) {
4             /* Fill in code here */
5         }
6     }
7     return result;
8 }
```

*p1 in %rdi, p2 in %rsi, action in %edx*

```
1      .L8:      MODE_E
2          movl  $27, %eax
3          ret
4      .L3:      MODE_A
5          movq  (%rsi), %rax
6          movq  (%rdi), %rdx
7          movq  %rdx, (%rsi)
8          ret
9      .L5:      MODE_B
10         movq  (%rdi), %rax
11         addq  (%rsi), %rax
12         movq  %rax, (%rdi)
13         ret
14     .L6:      MODE_C
15         movq  $59, (%rdi)
16         movq  (%rsi), %rax
17         ret
18     .L7:      MODE_D
19         movq  (%rsi), %rax
20         movq  %rax, (%rdi)
21         movl  $27, %eax
22         ret
23     .L9:      default
24         movl  $12, %eax
25         ret
```

**Figure 3.52** Assembly code for [Problem 3.62](#).

This code implements the different branches of a switch statement.

**Figure 3.53** shows the disassembled machine code for the procedure.

The jump table resides in a different area of memory. We can see from the indirect jump on line 5 that the jump table begins at address `0x4006f8`. Using the GDB debugger, we can examine the six 8-byte words of memory comprising the jump table with the command `x/6gx 0x4006f8`. GDB prints the following:

```
(gdb) x/6gx 0x4006f8
0x4006f8: 0x00000000004005a1
0x00000000004005c3
0x400708: 0x00000000004005a1
0x00000000004005aa
0x400718: 0x00000000004005b2
0x00000000004005bf
```

Fill in the body of the switch statement with C code that will have the same behavior as the machine code.

```

|
long switch_prob(long x, long n)
    x in %rdi, n in %rsi
1      0000000000400590 <switch_prob>:
2      400590: 48 83 ee 3c      sub    $0x3c,%rsi
3      400594: 48 83 fe 05      cmp    $0x5,%rsi
4      400598: 77 29   ja     4005c3 <switch_prob+0x33>
5      40059a: ff 24 f5 f8 06 40 00    jmpq  *0x4006f8(,%rsi,8)
6      4005a1: 48 8d 04 fd 00 00 00    lea   0x0(,%rdi,8),%rax
7      4005a8: 00
8      4005a9: c3      retq
9      4005aa: 4889f8  mov   %rdi,%rax
10     4005ad: 48 c1 f8 03      sar   $0x3,%rax
11     4005b1: c3      retq
12     4005b2: 4889f8  mov   %rdi,%rax
13     4005b5: 48 c1 e0 04      shl   $0x4,%rax
14     4005b9: 4829f8  sub   %rdi,%rax
15     4005bc: 4889c7  mov   %rax,%rdi
16     4005bf: 48 0f af ff      imul %rdi,%rdi
17     4005c3: 48 8d 47 4b      lea   0x4b(%rdi),%rax
18     4005c7: c3      retq

```

Figure 3.53 Disassembled code for [Problem 3.63](#) .



## 3.64

Consider the following source code, where  $R$ ,  $S$ , and  $T$  are constants declared with `#define`:

```
|  
1     long A[R][S][T];  
2  
3     long store_ele(long i, long j, long k, long  
*dest)  
4     {  
5         *dest = A[i][j][k];  
6         return sizeof(A);  
7     }
```

In compiling this program, gcc generates the following assembly code:

```

|
|
|      long store_ele(long i, long j, long k, long
|      *dest)
|      i in %rdi, j in %rsi, k in %rdx, dest in %rcx
1      store_ele:
2          leaq (%rsi,%rsi,2), %rax
3          leaq (%rsi,%rax,4), %rax
4          movq %rdi, %rsi
5          salq $6, %rsi
6          addq %rsi, %rdi
7          addq %rax, %rdi
8          addq %rdi, %rdx
9          movq A(,%rdx,8), %rax
10         movq %rax, (%rcx)
11         movl $3640, %eax
12         ret

```

- A. Extend [Equation 3.1](#) from two dimensions to three to provide a formula for the location of array element  $A[i][j][k]$ .
- B. Use your reverse engineering skills to determine the values of  $R$ ,  $S$ , and  $T$  based on the assembly code.

## 3.65

The following code transposes the elements of an  $M \times M$  array, where  $M$  is a constant defined by `#define`:

```
|  
1 void transpose(long A[M][M]) {  
2     long i, j;  
3     for (i = 0; i < M; i++)  
4         for (j = 0; j < i; j++) {  
5             long t = A[i][j];  
6             A[i][j] = A[j][i];  
7             A[j][i] = t;  
8         }  
9     }
```

When compiled with optimization level `-O1`, gcc generates the following code for the inner loop of the function:

```
|
1      .L6:
2      movq  (%rdx), %rcx
3      movq  (%rax), %rsi
4      movq  %rsi, (%rdx)
5      movq  %rcx, (%rax)
6      addq  $8, %rdx
7      addq  $120, %rax
8      cmpq  %rdi, %rax
9      jne   .L6
```

We can see that gcc has converted the array indexing to pointer code.

- A. Which register holds a pointer to array element `A[i]`  
`[j]`?
- B. Which register holds a pointer to array element `A[j]`  
`[i]`?
- C. What is the value of  $M$ ?

## 3.66

Consider the following source code, where `NR` and `NC` are macro expressions declared with `#define` that compute the dimensions of array `A` in terms of parameter `n`. This code computes the sum of the elements of column `j` of the array.

```
|  
1     long sum_col(long n, long A[NR(n)][NC(n)], long  
j) {  
2         long i;  
3         long result = 0;  
4         for (i = 0; i < NR(n); i++)  
5             result += A[i][j];  
6         return result;  
7     }
```

In compiling this program, `gcc` generates the following assembly code:

```

|
|
|   long sum_col(long n, long A[NR(n)][NC(n)], long
j)
|   n in %rdi, A in %rsi, j in %rdx
1   sum_col:
2       leaq 1(,%rdi,4), %r8
3       leaq (%rdi,%rdi,2), %rax
4       movq %rax, %rdi
5       testq %rax, %rax
6       jle .L4
7       salq $3, %r8
8       leaq (%rsi,%rdx,8), %rcx
9       movl $0, %eax
10      movl $0, %edx
11      .L3:
12      addq (%rcx), %rax
13      addq $1, %rdx
14      addq %r8, %rcx
15      cmpq %rdi, %rdx
16      jne .L3
17      rep; ret
18      .L4:
19      movl $0, %eax
20      ret

```

Use your reverse engineering skills to determine the definitions of `NR` and `NC`.

## 3.67

For this exercise, we will examine the code generated by `gcc` for functions that have structures as arguments and return values, and from this see how these language features are typically implemented.

The following C code has a function `process` having structures as argument and return values, and a function `eval` that calls `process`:

```
|
1     typedef struct {
2         long a[2];
3         long *p;
4     } strA;
5
6     typedef struct {
7         long u[2];
8         long q;
9     } strB;
10
11    strB process(strA s) {
12        strB r;
13        r.u[0] = s.a[1];
14        r.u[1] = s.a[0];
15        r.q = *s.p;
16        return r;
17    }
18
19    long eval(long x, long y, long z) {
20        strA s;
21        s.a[0] = x;
22        s.a[1] = y;
23        s.p = &z;
24        strB r = process(s);
25        return r.u[0] + r.u[1] + r.q;
26    }
```



Gcc generates the following code for these two functions:

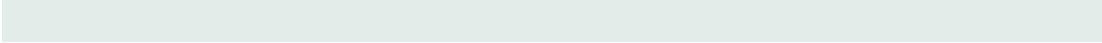
```
strB process(strA s)
```

```
1 process:  
2 movq %rdi, %rax  
3 movq 24(%rsp), %rdx  
4 movq (%rdx), %rdx  
5 movq 16(%rsp), %rcx  
6 movq %rcx, (%rdi)  
7 movq 8(%rsp), %rcx  
8 movq %rcx, 8(%rdi)  
9 movq %rdx, 16(%rdi)  
10 ret
```

```
long eval(long x, long y, long z)
```

```
x in %rdi, y in %rsi, z in %rdx
```

```
1 eval:  
2 subq $104, %rsp  
3 movq %rdx, 24(%rsp)  
4 leaq 24(%rsp), %rax  
5 movq %rdi, (%rsp)  
6 movq %rsi, 8(%rsp)  
7 movq %rax, 16(%rsp)  
8 leaq 64(%rsp), %rdi  
9 call process  
10 movq 72(%rsp), %rax  
11 addq 64(%rsp), %rax  
12 addq 80(%rsp), %rax  
13 addq $104, %rsp  
14 ret
```

- 
- A. We can see on line 2 of function `eval` that it allocates 104 bytes on the stack. Diagram the stack frame for `eval`, showing the values that it stores on the stack prior to calling `process`.
  - B. What value does `eval` pass in its call to `process`?
  - C. How does the code for `process` access the elements of structure arguments?
  - D. How does the code for `process` set the fields of result structure `r`?
  - E. Complete your diagram of the stack frame for `eval`, showing how `eval` accesses the elements of structure `r` following the return from `process`.
  - F. What general principles can you discern about how structure values are passed as function arguments and how they are returned as function results?

## 3.68

In the following code, *A* and *B* are constants defined with

`#define:`

```
|
1     typedef struct {
2         int x[A][B]; /* Unknown constants A and B
*/
3         long y;
4     } str1;
5
6     typedef struct {
7         char array[B];
8         int t;
9         short s[A];
10        long u;
11    } str2;
12
13    void setVal(str1 *p, str2 *q) {
14        long v1 = q-<t;
15        long v2 = q-<u;
16        p-<y = v1+v2;
17    }
```

Gcc generates the following code for `setVal:`

```
|  
void setVal(str1 *p, str2 *q) p in %rdi, q in  
%rsi  
1   setVal:  
2   movslq    8(%rsi), %rax  
3   addq    32(%rsi), %rax  
4   movq    %rax, 184(%rdi)  
5   ret
```

What are the values of  $A$  and  $B$ ? (The solution is unique.)

## 3.69

You are charged with maintaining a large C program, and you come across the following code:

```
|  
1     typedef struct {  
2         int first;  
3         a_struct a[CNT];  
4         int last;  
5     } b_struct;  
6  
7     void test(long i, b_struct *bp)  
8     {  
9         int n = bp->first + bp->last;  
10        a_struct *ap = &bp->a[i];  
11        ap->x[ap->idx] = n;  
12    }
```

The declarations of the compile-time constant `CNT` and the structure `a_struct` are in a file for which you do not have the necessary access privilege. Fortunately, you have a copy of the `.o` version of code, which you are able to disassemble with the `OBJDUMP` program, yielding the following disassembly:

```

void test(long i, b_struct *bp)
    i in %rdi, bp in %rsi
1      000000000000000000 <test>:
2      0: 8b 8e 20 01 00 00    mov     0x120(%rsi),%ecx
3      6: 030e                      add     (%rsi),%ecx
4      8: 48 8d 04 bf              lea    (%rdi,%rdi,4),%rax
5      c: 48 8d 04 c6              lea    (%rsi,%rax,8),%rax
6     10: 48 8b 50 08              mov     0x8(%rax),%rdx
7     14: 48 63 c9                movslq %ecx,%rcx
8     17: 48 89 4c d0 10          mov
%rcx,0x10(%rax,%rdx,8)
9     1c: c3                      retq

```

Using your reverse engineering skills, deduce the following:

- A. The value of `CNT`.
- B. A complete declaration of structure `a_struct`. Assume that the only fields in this structure are `idx` and `x`, and that both of these contain signed values.

## 3.70

Consider the following union declaration:

```
|  
1     union ele {  
2         struct {  
3             long *p;  
4             long y;  
5         } e1;  
6         struct {  
7             long x;  
8             union ele *next;  
9         } e2;  
10    };
```

This declaration illustrates that structures can be embedded within unions.

The following function (with some expressions omitted) operates on a linked list having these unions as list elements:

```
|  
1     void proc (union ele *up) {  
2         up-> _____ = *(_____) - _____;  
3     }
```

A. What are the offsets (in bytes) of the following fields:



```
|  
e1.p _____  
e1.y _____  
e2.x _____  
e2.next _____
```

- B. How many total bytes does the structure require?
- C. The compiler generates the following assembly code for `proc`:



```
|  
void proc (union ele *up) up in %rdi  
1 proc:  
2 movq 8(%rdi), %rax  
3 movq (%rax), %rdx  
4 movq (%rdx), %rdx  
5 subq 8(%rax), %rdx  
6 movq %rdx, (%rdi)  
7 ret
```

On the basis of this information, fill in the missing expressions in the code for `proc`. *Hint:* Some union references can have ambiguous interpretations. These ambiguities get resolved as you see where the references lead. There is only one answer that does not perform any casting and does not violate any type constraints.

## 3.71

Write a function `good_echo` that reads a line from standard input and writes it to standard output. Your implementation should work for an input line of arbitrary length. You may use the library function `fgets`, but you must make sure your function works correctly even when the input line requires more space than you have allocated for your buffer. Your code should also check for error conditions and return when one is encountered. Refer to the definitions of the standard I/O functions for documentation [\[45, 61\]](#).

## 3.72

**Figure 3.54(a)**  shows the code for a function that is similar to function `vfunct` (**Figure 3.43(a)** ). We used `vfunct` to illustrate the use of a frame pointer in managing variable-size stack frames. The new function `aframe` allocates space for local

(a) C code

```
|  
1     #include <alloca.h>  
2  
3     long aframe(long n, long idx, long *q) {  
4         long i;  
5         long **p = alloca(n * sizeof(long *));  
6         p[0] = &i;  
7         for (i = 1; i < n; i++)  
8             p[i] = q;  
9         return *p[idx];  
10 }
```

(b) Portions of generated assembly code

```


|
|
|   long aframe(long n, long idx, long *q)
|   n in %rdi, idx in %rsi, q in %rdx
1   aframe:
2   pushq   %rbp
3   movq    %rsp, %rbp
4   subq    $16, %rsp Allocate space for i (%rsp = s1)
5   leaq   30(,%rdi,8), %rax
6   andq   $-16, %rax
7   subq   %rax, %rsp Allocate space for array p
|   (%rsp = s2)
8   leaq   15(%rsp), %r8
9   andq   $-16, %r8 Set %r8 to &p[0]
|   :


```

**Figure 3.54** Code for **Problem 3.72** .

This function is similar to that of **Figure 3.43** .


array `p` by calling library function `alloca`. This function is similar to the more commonly used function `malloc`, except that it allocates space on the run-time stack. The space is automatically deallocated when the executing procedure returns.

**Figure 3.54(b)**  shows the part of the assembly code that sets up the frame pointer and allocates space for local variables `i` and `p`. It is very similar to the corresponding code for `vframe`. Let us use the same notation as in **Problem**


**3.49** : The stack pointer is set to values  $s_1$  at line 4 and  $s_2$  at line 7. The start address of array `p` is set to value  $p$  at line 9. Extra space  $e_2$  may arise between  $s_2$  and  $p$ , and extra space  $e_1$  may arise between the end of array `p` and  $s_1$ .

- A. Explain, in mathematical terms, the logic in the computation of  $s_2$ .
- B. Explain, in mathematical terms, the logic in the computation of  $p$ .
- C. Find values of  $n$  and  $s_1$  that lead to minimum and maximum values of  $e_1$ .
- D. What alignment properties does this code guarantee for the values of  $s_2$  and  $p$ ?

## 3.73

Write a function in assembly code that matches the behavior of the function `find_range` in **Figure 3.51** . Your code should contain only one floating-point comparison instruction, and then it should use conditional branches to generate the correct result. Test your code on all  $2^{32}$  possible argument values. Web Aside ASM:EASM on page 178 describes how to incorporate functions written in assembly code into C programs.

## 3.74

Write a function in assembly code that matches the behavior of the function `find_range` in **Figure 3.51** . Your code should contain only one floating-point comparison instruction, and then it should use conditional moves to generate the correct result. You might want to make use of the instruction `cmovp` (move if even parity). Test your code on all  $2^{32}$  possible argument values. Web Aside ASM:EASM on page 178 describes how to incorporate functions written in assembly code into C programs.

## 3.75

ISO C99 includes extensions to support complex numbers. Any floating-point type can be modified with the keyword `complex`. Here are some sample functions that work with complex data and that call some of the associated library functions:

```
|
1     #include <complex.h> 2
3     double c_imag(double complex x) {
4         return cimag(x);
5     }
6
7     double c_real(double complex x) {
8         return creal(x);
9     }
10
11    double complex c_sub(double complex x, double
complex y) {
12        return x - y;
13    }
```

When compiled, `gcc` generates the following assembly code for these functions:



```
|
    double c_imag(double complex x)
1      c_imag:
2          movapd  %xmm1, %xmm0
3          ret

    double c_real(double complex x)
4      c_real:
5          rep; ret

    double complex c_sub(double complex x, double
complex y)
6      c_sub:
7          subsd  %xmm2, %xmm0
8          subsd  %xmm3, %xmm1
9          ret
```

Based on these examples, determine the following:

- A. How are complex arguments passed to a function?
- B. How are complex values returned from a function?

# Solutions to Practice Problems

## **Solution to Problem 3.1** (page 182)

This exercise gives you practice with the different operand forms.

# Solution to Problem 3.2 (page 185)

As we have seen, the assembly code generated by `gcc` includes suffixes on the instructions, while the disassembler does not. Being able to switch between these two forms is an important skill to learn. One important feature is that memory references in x86-64 are always given with quad word registers, such as `%rax`, even if the operand is a byte, single word, or double word.

Here is the code written with suffixes:

```
|
movl    %eax, (%rsp)
movw    (%rax), %dx
movb    $0xFF, %bl
movb    (%rsp,%rdx,4), %dl
movq    (%rdx), %rax
movw    %dx, (%rax)
```

# Solution to Problem 3.3 (page 186)

Since we will rely on gcc to generate most of our assembly code, being able to write correct assembly code is not a critical skill. Nonetheless, this exercise will help you become more familiar with the different instruction and operand types.

Here is the code with explanations of the errors:

```
|  
movb    $0xF, (%ebx)    Cannot use %ebx as address register  
movl    %rax, (%rsp)    Mismatch between instruction suffix  
and register ID  
movw    (%rax),4(%rsp)  Cannot have both source and  
destination be memory references  
movb    %al,%sl        No register named %sl  
movl    %eax,$0x123    Cannot have immediate as destination  
movl    %eax,%dx       Destination operand incorrect size  
movb    %si, 8(%rbp)   Mismatch between instruction suffix  
and register ID
```

# Solution to Problem 3.4 (page 187)

This exercise gives you more experience with the different data movement instructions and how they relate to the data types and conversion rules of C. The nuances of conversions of both signedness and size, as well as integral promotion, add challenge to this problem.

## Solution to Problem 3.5 (page 189)

Reverse engineering is a good way to understand systems. In this case, we want to reverse the effect of the C compiler to determine what C code gave rise to this assembly code. The best way is to run a "simulation," starting with values `x`, `y`, and `z` at the locations designated by pointers `xp`, `yp`, and `zp`, respectively. We would then get the following behavior:

```
|
|
|     void decode1(long *xp, long *yp, long *zp)
|     xp in %rdi, yp in %rsi, zp in %rdx
| decode1:
|     movq    (%rdi), %r8      Get x = *xp
|     movq    (%rsi), %rcx    Get y = *yp
|     movq    (%rdx), %rax    Get z = *zp
|     movq    %r8, (%rsi)    Store x at yp
|     movq    %rcx, (%rdx)    Store y at zp
|     movq    %rax, (%rdi)    Store z at xp
|     ret
```

From this, we can generate the following C code:

```
|  
void decode1(long *xp, long *yp, long *zp)  
{  
    long x = *xp;  
    long y = *yp;  
    long z = *zp;  
  
    *yp = x;  
    *zp = y;  
    *xp = z;  
}
```

## Solution to Problem 3.6 (page 192)

This exercise demonstrates the versatility of the `leaq` instruction and gives you more practice in deciphering the different operand forms. Although the operand forms are classified as type "Memory" in [Figure 3.3 !\[\]\(d84e7ea36f695d92cb39ec32c307ac93\_img.jpg\)](#), no memory access occurs.

# Solution to Problem 3.7 (page 193)

Again, reverse engineering proves to be a useful way to learn the relationship between C code and the generated assembly code.

The best way to solve problems of this type is to annotate the lines of assembly code with information about the operations being performed. Here is a sample:

```
|  
    long scale2(long x, long y, long z)  
    x in %rdi, y in %rsi, z in %rdx  
scale2:  
    leaq (%rdi,%rdi,4), %rax    5*x  
    leaq (%rax,%rsi,2), %rax    5*x+2*y  
    leaq (%rax,%rdx,8), %rax    5*x+2*y+8*z  
    ret
```

From this, it is easy to generate the missing expression:

```
|  
long t = 5 * x + 2 * y + 8 * z;
```



# Solution to Problem 3.8 (page 194)

This problem gives you a chance to test your understanding of operands and the arithmetic instructions. The instruction sequence is designed so that the result of each instruction does not affect the behavior of subsequent ones.

# Solution to Problem 3.9 (page 195)

This exercise gives you a chance to generate a little bit of assembly code. The solution code was generated by `gcc`. By loading parameter `n` in register `%ecx`, it can then use byte register `%cl` to specify the shift amount for the `sarq` instruction. It might seem odd to use a `movl` instruction, given that `n` is eight bytes long, but keep in mind that only the least significant byte is required to specify the shift amount.

```
|
|
|      long shift_left4_rightn(long x, long n)
|      x in %rdi, n in %rsi
|
| shift_left4_rightn:
|      movq    %rdi, %rax      Get x
|      salq   $4, %rax        x <<= 4
|      movl   %esi, %ecx      Get n (4 bytes)
|      sarq   %cl, %rax       x >>= n
```

# Solution to Problem 3.10 (page 196)

This problem is fairly straightforward, since the assembly code follows the structure of the C code closely.

```
|  
long t1 = x | y;  
long t2 = t1 << 3;  
long t3 = ~t2;  
long t4 = z - t3;
```

# Solution to Problem 3.11 (page 197)

- A. This instruction is used to set register `%rdx` to zero, exploiting the property that  $x \wedge x = 0$  for any  $x$ . It corresponds to the C statement `x = 0`.
- B. A more direct way of setting register `%rdx` to zero is with the instruction `movq $0,%rdx`.
- C. Assembling and disassembling this code, however, we find that the version with `xorq` requires only 3 bytes, while the version with `movq` requires 7. Other ways to set `%rdx` to zero rely on the property that any instruction that updates the lower 4 bytes will cause the high-order bytes to be set to zero. Thus, we could use either `xorl %edx,%edx` (2 bytes) or `movl $0,%edx` (5 bytes).

# Solution to Problem 3.12 (page 200)

We can simply replace the `cqto` instruction with one that sets register `%rdx` to `zero`, and use `divq` rather than `idivq` as our division instruction, yielding the following code:

```
|
|
|     void uremdiv(unsigned long x, unsigned long y,
|     unsigned long *qp, unsigned long *rp)
|     x in %rdi, y in %rsi, qp in %rdx, rp in %rcx
1     uremdiv:
2     movq %rdx, %r8      Copy qp
3     movq %rdi, %rax    Move x to lower 8 bytes of
|     dividend
4     movl $0, %edx     Set upper 8 bytes of dividend
|     to 0
5     divq %rsi        Divide by y
6     movq %rax, (%r8)  Store quotient at qp
7     movq %rdx, (%rcx) Store remainder at rp
8     ret
```

# Solution to Problem 3.13 (page 204)

It is important to understand that assembly code does not keep track of the type of a program value. Instead, the different instructions determine the operand sizes and whether they are signed or unsigned. When mapping from instruction sequences back to C code, we must do a bit of detective work to infer the data types of the program values.

- A. The suffix ``l'` and the register identifiers indicate 32-bit operands, while the comparison is for a two's-complement `<`. We can infer that `data_t` must be `int`.
- B. The suffix ``w'` and the register identifiers indicate 16-bit operands, while the comparison is for a two's-complement `>=`. We can infer that `data_t` must be `short`.
- C. The suffix ``b'` and the register identifiers indicate 8-bit operands, while the comparison is for an unsigned `<=`. We can infer that `data_t` must be `unsigned char`.
- D. The suffix ``q'` and the register identifiers indicate 64-bit operands, while the comparison is for `!=`, which is the same whether the arguments are signed, unsigned, or pointers. We can infer that `data_t` could be either `long`, `unsigned long`, or some form of pointer.

# Solution to Problem 3.14 (page 205)

This problem is similar to [Problem 3.13](#), except that it involves `TEST` instructions rather than `CMP` instructions.

- A. The suffix ``q'` and the register identifiers indicate a 64-bit operand, while the comparison is for `>=`, which must be signed. We can infer that `data_t` must be `long`.
- B. The suffix ``w'` and the register identifier indicate a 16-bit operand, while the comparison is for `==`, which is the same for signed or unsigned. We can infer that `data_t` must be either `short` or `unsigned short`.
- C. The suffix ``b'` and the register identifier indicate an 8-bit operand, while the comparison is for unsigned `>`. We can infer that `data_t` must be `unsigned char`.
- D. The suffix ``l'` and the register identifier indicate 32-bit operands, while the comparison is for `<`. We can infer that `data_t` must be `int`.

# Solution to Problem 3.15 (page 209)

This exercise requires you to examine disassembled code in detail and reason about the encodings for jump targets. It also gives you practice in hexadecimal arithmetic.

- A. The `je` instruction has as its target `0x4003fc + 0x02`. As the original disassembled code shows, this is `0x4003fe`:

```
|  
4003fa:7402          je      4003fe  
4003fc:ffd0          callq  *%rax
```

- B. The `je` instruction has as its target `0x0x400431 - 12` (since `0xf4` is the 1-byte two's-complement representation of  $-12$ ). As the original disassembled code shows, this is `0x400425`:

```
|  
40042f:74f4          je      400425  
400431: 5d          pop    %rbp
```



C. According to the annotation produced by the disassembler, the jump target is at absolute address `0x400547`. According to the byte encoding, this must be at an address `0x2` bytes beyond that of the pop instruction. Subtracting these gives address `0x400545`. Noting that the encoding of the `ja` instruction requires 2 bytes, it must be located at address `0x400543`. These are confirmed by examining the original disassembly:

```
400543: 77 02    ja     400547
400545: 5d      pop   %rbp
```

D. Reading the bytes in reverse order, we can see that the target offset is `0xffffffff73`, or decimal -141. Adding this to `0x0x4005ed` (the address of the nop instruction) gives address `0x400560`:

```
4005e8: e9 73 ff ff ff  jmpq  400560
4005ed: 90      nop
```

# Solution to Problem 3.16 (page 212)

Annotating assembly code and writing C code that mimics its control flow are good first steps in understanding assembly-language programs. This problem gives you practice for an example with simple control flow. It also gives you a chance to examine the implementation of logical operations.

A. Here is the C code:

```
void goto_cond(long a, long *p) {  
    if (p == 0)  
        goto done;  
    if (*p >= a)  
        goto done;  
    *p = a;  
done:  
    return;  
}
```

B. The first conditional branch is part of the implementation of the `&&` expression. If the test for `p` being non-null fails, the code will skip the test of `a > *p`.

# Solution to Problem 3.17 (page 212)

This is an exercise to help you think about the idea of a general translation rule and how to apply it.

- A. Converting to this alternate form involves only switching around a few lines of the code:

```
|
long gotodiff_se_alt(long x, long y) {
    long result;
    if (x < y)
        goto x_lt_y;
    ge_cnt++;
    result = x - y;
    return result;
x_lt_y:
    lt_cnt++;
    result = y - x;
    return result;
}
```

- B. In most respects, the choice is arbitrary. But the original rule works better for the common case where there is no

else statement. For this case, we can simply modify the translation rule to be as follows:

```
|  
    t = test-expr;  
    if (!t)  
        goto done;  
    then-statement  
done:
```

A translation based on the alternate rule is more cumbersome.

## Solution to Problem 3.18 (page 213)

This problem requires that you work through a nested branch structure, where you will see how our rule for translating `if` statements has been applied. On the whole, the machine code is a straightforward translation of the C code.

```
|
long test(long x, long y, long z) {
    long val = x+y+z;
    if (x < -3) {
        if (y < z)
            val = x*y;
        else
            val = y*z;
    } else if (x > 2)
        val = x*z;
    return val;
}
```

# Solution to Problem 3.19 (page 216)

This problem reinforces our method of computing the misprediction penalty.

- A. We can apply our formula directly to get  $T_{MP} = 2(31 - 16) = 30$ .
- B. When misprediction occurs, the function will require around  $16 + 30 = 46$  cycles.

# Solution to Problem 3.20 (page 219)

This problem provides a chance to study the use of conditional moves.

- A. The operator is `l/`. We see this is an example of dividing by a power of 3 by right shifting (see [Section 2.3.7](#)). Before shifting by  $k = 3$ , we must add a bias of  $2^k - 1 = 7$  when the dividend is negative.
- B. Here is an annotated version of the assembly code:

```
|
| long arith(long x)
| x in %rdi
arith:
| leaq 7(%rdi), %rax temp = x+7
| testq %rdi, %rdi Text x
| cmovns %rdi, %rax If x >= 0, temp = x
| sarq $3, %rax result = temp >> 3 (= x/8)
| ret
```

The program creates a temporary value equal to  $x + 7$ , in anticipation of  $x$  being negative and therefore requiring biasing. The `cmovns` instruction conditionally changes this

number to  $x$  when  $x \geq 0$ , and then it is shifted by 3 to generate  $x/8$ .

## Solution to Problem 3.21 (page 219)

This problem is similar to [Problem 3.18 !\[\]\(34b4f260a8587d2e97eeaee361cc357b\_img.jpg\)](#), except that some of the conditionals have been implemented by conditional data transfers. Although it might seem daunting to fit this code into the framework of the original C code, you will find that it follows the translation rules fairly closely.

```
|
long test(long x, long y) {
    long val = 8*x;
    if (y > 0) {
        if (x < y)
            val = y-x;
        else
            val = x&y;
    } else if (y <= -2)
        val = x+y;
    return val;
}
```



# Solution to Problem 3.22 [↗](#)(page 221)

A. If we build up a table of factorials computed with data type `int`, we get the following:

We can see that the computation of  $13!$  has overflowed. As we learned in [Problem 2.35](#), when we get value  $x$  while attempting to compute  $n!$ , we can test for overflow by computing  $x/n$  and seeing whether it equals  $(n - 1)!$  (assuming that we have already ensured that the computation of  $(n - 1)!$  did not overflow). In this case we get  $1,932,053,504/13 = 161,004,458.667$ . As a second test, we can see that any factorial beyond  $10!$  must be a multiple of  $100$  and therefore have zeros for the last two digits. The correct value of  $13!$  is  $6,227,020,800$ .

- B. Doing the computation with data type `long` lets us go up to  $20!$ , yielding  $2,432,902,008,176,640,000$ .

# Solution to Problem 3.23 (page 222)

The code generated when compiling loops can be tricky to analyze, because the compiler can perform many different optimizations on loop code, and because it can be difficult to match program variables with registers. This particular example demonstrates several places where the assembly code is not just a direct translation of the C code.

- A. Although parameter `x` is passed to the function in register `%rdi`, we can see that the register is never referenced once the loop is entered. Instead, we can see that registers `%rax`, `%rcx`, and `%rdx` are initialized in lines 2–5 to `x`, `x*x`, and `x+x`. We can conclude, therefore, that these registers contain the program variables.
- B. The compiler determines that pointer `p` always points to `x`, and hence the expression `(*p)++` simply increments `x`. It combines this incrementing by 1 with the increment by `y`, via the `leaq` instruction of line 7.
- C. The annotated code is as follows:

```

|
|
|   long dw_loop(long x)
|   x initially in %rdi
1   dw_loop:
2   movq   %rdi, %rax           Copy x to %rax
3   movq   %rdi, %rcx
4   imulq %rdi, %rcx           Compute y =
x*x
5   leaq   (%rdi,%rdi), %rdx    Compute n =
2*x
6   .L2:                          loop:
7   leaq   1(%rcx,%rax), %rax    Compute x += y
+ 1
8   subq   $1, %rdx             Decrement n
9   testq  %rdx, %rdx           Test n
10  jg     .L2                  If > 0, goto
loop
11  rep;   ret                  Return

```

# Solution to Problem 3.24 (page 224)

This assembly code is a fairly straightforward translation of the loop using the jump-to-middle method. The full C code is as follows:

```
|  
long loop_while(long a, long b)  
{  
    long result = 1;  
    while (a < b) {  
        result = result * (a+b);  
        a = a+1;  
    }  
    return result;  
}
```

## Solution to Problem 3.25 (page 226)

While the generated code does not follow the exact pattern of the guarded-do translation, we can see that it is equivalent to the following C code:

```
|  
long loop_while2(long a, long b)  
{  
    long result = b;  
    while (b > 0) {  
        result = result * a;  
        b = b-a;  
    }  
    return result;  
}
```

We will often see cases, especially when compiling with higher levels of optimization, where `gcc` takes some liberties in the exact form of the code it generates, while preserving the required functionality.

# Solution to Problem 3.26 (page 228)

Being able to work backward from assembly code to C code is a prime example of reverse engineering.

A. We can see that the code uses the jump-to-middle translation, using the `jmp` instruction on line 3.

B. Here is the original C code:

```
long fun_a(unsigned long x) {  
    long val = 0;  
    while (x) {  
        val ^= x;  
        x >>= 1;  
    }  
    return val & 0x1;  
}
```

C. This code computes the *parity* of argument `x`. That is, it returns 1 if there is an odd number of ones in `x` and 0 if there is an even number.

# Solution to Problem 3.27 (page 231)

This exercise is intended to reinforce your understanding of how loops are implemented.

```
|  
long fact_for_gd_goto(long n)  
{  
    long i = 2;  
    long result = 1;  
    if (n <= 1)  
        goto done;  
loop:  
    result *= i;  
    i++;  
    if (i <= n)  
        goto loop;  
done:  
    return result;  
}
```



# Solution to Problem 3.28 (page 231)

This problem is trickier than [Problem 3.26](#), since the code within the loop is more complex and the overall operation is less familiar.

A. Here is the original C code:

```
long fun_b(unsigned long x) {  
    long val = 0;  
    long i;  
    for (i = 64; i != 0; i-) {  
        val = (val << 1) | (x & 0x1);  
        x >>= 1;  
    }  
    return val;  
}
```

B. The code was generated using the guarded-do transformation, but the compiler detected that, since  $i$  is initialized to 64, it will satisfy the test  $i \neq 0$ , and therefore the initial test is not required.

C. This code reverses the bits in `x`, creating a mirror image. It does this by shifting the bits of `x` from left to right, and then filling these bits in as it shifts `val` from right to left.

[OceanofPDF.com](http://OceanofPDF.com)

## Solution to Problem 3.29 (page 232)

Our stated rule for translating a for loop into a `while` loop is just a bit too simplistic—this is the only aspect that requires special consideration.

- A. Applying our translation rule would yield the following code:

```
/* Naive translation of for loop into while loop */
/* WARNING: This is buggy code */
long sum = 0;
long i = 0;
while (i < 10) {
    if (i & 1)
        /* This will cause an infinite loop */
        continue;
    sum += i;
    i++;
}
```

This code has an infinite loop, since the continue statement would prevent index variable `i` from being updated.

- B. The general solution is to replace the continue statement with a `goto` statement that skips the rest of the loop body and goes directly to the update portion:

```
/* Correct translation of for loop into while loop */
long sum = 0;
long i = 0;
while (i < 10) {
    if (i & 1)
        goto update;
    sum += i;
update:
    i++;
}
```

# Solution to Problem 3.30 (page 236)

This problem gives you a chance to reason about the control flow of a switch statement. Answering the questions requires you to combine information from several places in the assembly code.

- Line 2 of the assembly code adds 1 to  $x$  to set the lower range of the cases to zero. That means that the minimum case label is  $-1$ .
- Lines 3 and 4 cause the program to jump to the default case when the adjusted case value is greater than 8. This implies that the maximum case label is  $-1 + 8 = 7$ .
- In the jump table, we see that the entry on lines 6 (case value 3) and 9 (case value 6) have the same destination (`.L2`) as the jump instruction on line 4, indicating the default case behavior. Thus, case labels 3 and 5 are missing in the switch statement body.
- In the jump table, we see that the entries on lines 3 and 10 have the same destination. These correspond to cases 0 and 7.
- In the jump table, we see that the entries on lines 5 and 7 have the same destination. These correspond to cases 2 and 4.

From this reasoning, we draw the following conclusions:

- A. The case labels in the switch statement body have values `-1, 0, 1, 2, 4, 5, and 7`.
- B. The case with destination `.L5` has labels `0` and `7`.
- C. The case with destination `.L7` has labels `2` and `4`.

# Solution to Problem 3.31 (page 237)

The key to reverse engineering compiled switch statements is to combine the information from the assembly code and the jump table to sort out the different cases. We can see from the `ja` instruction (line 3) that the code for the default case has label `.L2`. We can see that the only other repeated label in the jump table is `.L5`, and so this must be the code for the cases C and D. We can see that the code falls through at line 8, and so label `.L7` must match case A and label `.L3` must match case B. That leaves only label `.L6` to match case E.

The original C code is as follows:

```
|  
void switcher(long a, long b, long c, long *dest)  
{  
    long val;  
    switch(a) {  
        case 5:  
            c = b ^ 15;  
            /* Fall through */  
        case 0:  
            val = c + 112;  
            break;  
        case 2:  
        case 7:  
            val = (c + b) << 2;  
            break;  
        case 4:  
            val = a;  
            break;  
        default:  
            val = b;  
    }  
    *dest = val;  
}
```



## Solution to Problem 3.32 [↗](#)(page 244)

Tracing through the program execution at this level of detail reinforces many aspects of procedure call and return. We can see clearly how control is passed to the function when it is called, and how the calling function resumes upon return. We can also see how arguments get passed through registers `%rdi` and `%rsi`, and how results are returned via register `%rax`.

# Solution to Problem 3.33 (page 246)

This problem is a bit tricky due to the mixing of different data sizes.

Let us first describe one answer and then explain the second possibility. If we assume the first addition (line 3) implements `*u += a`, while the second (line 4) implements `v += b`, then we can see that `a` was passed as the first argument in `%edi` and converted from 4 bytes to 8 before adding it to the 8 bytes pointed to by `%rdx`. This implies that `a` must be of type `int` and `u` must be of type `long *`. We can also see that the low-order byte of argument `b` is added to the byte pointed to by `%rcx`. This implies that `v` must be of type `char *`, but the type of `b` is ambiguous—it could be 1, 2, 4, or 8 bytes long. This ambiguity is resolved by noting the return value of 6, computed as the sum of the sizes of `a` and `b`. Since we know `a` is 4 bytes long, we can deduce that `b` must be 2.

An annotated version of this function explains these details:

```

|
|   int procprob(int a, short b, long *u, char *v)
|   a in %edi, b in %si, u in %rdx, v in %rcx
1   procprob:
2   movslq    %edi, %rdi    Convert a to long
3   addq     %rdi, (%rdx)   Add to *u (long)
4   addb     %sil, (%rcx)   Add low-order byte of
|   b to *v
5   movl    $6, %eax       Return 4+2
6   ret

```

Alternatively, we can see that the same assembly code would be valid if the two sums were computed in the assembly code in the opposite ordering as they are in the C code. This would result in interchanging arguments `a` and `b` and arguments `u` and `v`, yielding the following prototype:

```

|
|   int procprob(int b, short a, long *v, char *u);

```

# Solution to Problem 3.34 (page 252)

This example demonstrates the use of callee-saved registers as well as the stack for holding local data.

- A. We can see that lines 9-14 save local values `a0-a5` into callee-saved registers `%rbx, %r15, %r14, %r13, %r12`, and `%rbp`, respectively.
- B. Local values `a6` and `a7` are stored on the stack at offsets 0 and 8 relative to the stack pointer (lines 16 and 18).
- C. After storing six local variables, the program has used up the supply of callee-saved registers. It stores the remaining two local values on the stack.

# Solution to Problem 3.35 (page 254)

This problem provides a chance to examine the code for a recursive function. An important lesson to learn is that recursive code has the exact same structure as the other functions we have seen. The stack and register-saving disciplines suffice to make recursive functions operate correctly.

- A. Register `%rbx` holds the value of parameter `x`, so that it can be used to compute the result expression.
- B. The assembly code was generated from the following C code:

```
long rfun(unsigned long x) {  
    if (x == 0)  
        return 0;  
    unsigned long nx = x>>2;  
    long rv = rfun(nx);  
    return x + rv;  
}
```

## Solution to Problem 3.36 [↗](#)(page 256)

This exercise tests your understanding of data sizes and array indexing. Observe that a pointer of any kind is 8 bytes long. Data type `short` requires 2 bytes, while `int` requires 4.

## Solution to Problem 3.37 [↗](#)(page 258)

This problem is a variant of the one shown for integer array E. It is important to understand the difference between a pointer and the object being pointed to. Since data type `short` requires 2 bytes, all of the array indices are scaled by a factor of 2. Rather than using `movl`, as before, we now use `movw`.

# Solution to Problem 3.38 (page 259)

This problem requires you to work through the scaling operations to determine the address computations, and to apply [Equation 3.1](#) for row-major indexing. The first step is to annotate the assembly code to determine how the address references are computed:

```
|
|
|   long sum_element(long i, long j)
|   i in %rdi, j in %rsi
1   sum_element:
2       leaq 0(,%rdi,8), %rdx      Compute 8i
3       subq %rdi, %rdx          Compute 7i
4       addq %rsi, %rdx          Compute 7i + j
5       leaq (%rsi,%rsi,4), %rax  Compute 5j
6       addq %rax, %rdi          Compute i + 5j
7       movq Q(,%rdi,8), %rax    Retrieve M[xQ + 8 (5j
+ i)]
8       addq P(,%rdx,8), %rax    Add M[xP + 8 (7i +
j)]
9       ret
```

We can see that the reference to matrix `P` is at byte offset  $8 \cdot (7i + j)$ , while the reference to matrix `Q` is at byte offset  $8 \cdot (5j + i)$ . From this, we can determine that `P` has 7 columns, while `Q` has 5, giving  $M = 5$  and  $N = 7$ .

## Solution to Problem 3.39 (page 262)

These computations are direct applications of [Equation 3.1](#):

- For  $L = 4$ ,  $C = 16$ , and  $j = 0$ , pointer `Aptr` is computed as  $x_A + 4 \cdot (16i + 0) = x_A + 64i$ .
- For  $L = 4$ ,  $C = 16$ ,  $i = 0$ , and  $j = k$ , `Bptr` is computed as  $x_B + 4 \cdot (16 \cdot 0 + k) = x_B + 4k$ .
- For  $L = 4$ ,  $C = 16$ ,  $i = 16$ , and  $j = k$ , `Bend` is computed as  $x_B + 4 \cdot (16 \cdot 16 + k) = x_B + 1,024 + 4k$ .



# Solution to Problem 3.40 (page 262)

This exercise requires that you be able to study compiler-generated assembly code to understand what optimizations have been performed. In this case, the compiler was clever in its optimizations.

Let us first study the following C code, and then see how it is derived from the assembly code generated for the original function.

```
|
|
| /* Set all diagonal elements to val */
| void fix_set_diag_opt(fix_matrix A, int val) {
|     int *Abase = &A[0][0];
|     long i = 0;
|     long iend = N*(N+1);
|     do {
|         Abase[i] = val;
|         i += (N+1);
|     } while (i != iend);
| }
```

This function introduces a variable `Abase`, of type `int *`, pointing to the start of array `A`. This pointer designates a sequence of 4-

byte integers consisting of elements of  $A$  in row-major order. We introduce an integer variable  $index$  that steps through the diagonal elements of  $A$ , with the property that diagonal elements  $i$  and  $i + 1$  are spaced  $N + 1$  elements apart in the sequence, and that once we reach diagonal element  $N$  (index value  $N(N + 1)$ ), we have gone beyond the end.

The actual assembly code follows this general form, but now the pointer increments must be scaled by a factor of 4. We label register `%rax` as holding a value `index4` equal to  $index$  in our C version but scaled by a factor of 4. For  $N = 16$ , we can see that our stopping point for `index4` will be  $4 \cdot 16(16 + 1) = 1,088$ .

```

|
1      fix_set_diag:
      void fix_set_diag(fix_matrix A, int val)
      A in %rdi, val in %rsi
2      movl  0, %eax           Set index4 = 0
3      .L13:                   loop:
4      movl  %esi, (%rdi,%rax) Set Abase[index4/4]
      to val
5      addq  $68, %rax         Increment index4 +=
      4(N+1)
6      cmpq  $1088, %rax      Compare index4:
      4N(N+1)
7      jne   .L13             If !=, goto loop
8      rep; ret              Return

```

# Solution to Problem 3.41 (page 268)

This problem gets you to think about structure layout and the code used to access structure fields. The structure declaration is a variant of the example shown in the text. It shows that nested structures are allocated by embedding the inner structures within the outer ones.

A. The layout of the structure is as follows:



B. It uses 24 bytes.

C. As always, we start by annotating the assembly code:

```

|
  void sp_init(struct prob *sp)
  sp in %rdi
1  sp_init:
2      movl 12(%rdi), %eax  Get sp->s.y
3      movl %eax, 8(%rdi)  Save in sp->s.x
4      leaq 8(%rdi), %rax  Compute &(sp->s.x)
5      movq %rax, (%rdi)   Store in sp->p
6      movq %rdi, 16(%rdi) Store sp in sp->next
7      ret

```

From this, we can generate C code as follows:

```

|
void sp_init(struct prob *sp)
{
    sp->s.x = sp->s.y;
    sp->p    = &(sp->s.x);
    sp->next = sp;
}

```

# Solution to Problem 3.42 (page 269)

This problem demonstrates how a very common data structure and operation on it is implemented in machine code. We solve the problem by first annotating the assembly code, recognizing that the two fields of the structure are at offsets 0 (for `v`) and 8 (for `p`).

```
|
|
|      long fun(struct ELE *ptr)
|      ptr in %rdi
1      fun:
2      movl  $0, %eax      result = 0
3      jmp   .L2          Goto middle
4      .L3:              loop:
5      addq  (%rdi), %rax  result += ptr->v
6      movq  8(%rdi), %rdi ptr = ptr->p
7      .L2:              middle:
8      testq %rdi, %rdi   Test ptr
9      jne   .L3          If != NULL, goto loop
10     rep; ret
```

A. Based on the annotated code, we can generate a C version:

```
|
long fun(struct ELE *ptr) {
    long val = 0;
    while (ptr) {
        val += ptr->v;
        ptr = ptr->p;
    }
    return val;
}
```

B. We can see that each structure is an element in a singly linked list, with field `v` being the value of the element and `p` being a pointer to the next element. Function `fun` computes the sum of the element values in the list.

## Solution to Problem 3.43 [☐](#)(page 272)

Structures and unions involve a simple set of concepts, but it takes practice to be comfortable with the different referencing patterns and their implementations.

# Solution to Problem 3.44 (page 275)

Understanding structure layout and alignment is very important for understanding how much storage different data structures require and for understanding the code generated by the compiler for accessing structures. This problem lets you work out the details of some example structures.

- A. `struct P1 { int i; char c; int j; char d; };`
- B. `struct P2 { int i; char c; char d; long j; };`
- C. `struct P3 { short w[3]; char c[3] };`
- D. `struct P4 { short w[5]; char *c[3] };`
- E. `struct P5 { struct P3 a[2]; struct P2 t };`

# Solution to Problem 3.45 (page 275)

This is an exercise in understanding structure layout and alignment.

- A. Here are the object sizes and byte offsets:
- B. The structure is a total of 56 bytes long. The end of the structure must be padded by 4 bytes to satisfy the 8-byte alignment requirement.
- C. One strategy that works, when all data elements have a length equal to a power of 2, is to order the structure elements in descending order of size. This leads to a declaration



```
|  
struct {  
    char *a;  
    double c;  
    long g;  
    float e;  
    int h;  
    short b;  
    char d;  
    char f;  
}  
rec;
```

with the following offsets:

The structure must be padded by 4 bytes to satisfy the 8-byte alignment requirement, giving a total of 40 bytes.

# Solution to Problem 3.46 (page 282)

This problem covers a wide range of topics, such as stack frames, string representations, ASCII code, and byte ordering. It demonstrates the dangers of out-of-bounds memory references and the basic ideas behind buffer overflow.

A. Stack after line 3:

00 00 00 00 00 40 00 76	Return address
01 23 45 67 89 AB CD EF	Saved %rbx
	← buf = %rsp

B. Stack after line 5:

00 00 00 00 00 40 00 34	Return address
33 32 31 30 39 38 37 36	Saved %rbx
35 34 33 32 31 30 39 38	
37 36 35 34 33 32 31 30	← buf = %rsp

C. The program is attempting to return to address `0x040034`. The low-order 2 bytes were overwritten by the code for character ``4'` and the terminating null character.

- D. The saved value of register `%rbx` was set to `0x3332313039383736`. This value will be loaded into the register before `get_line` returns.
- E. The call to `malloc` should have had `strlen(buf)+1` as its argument, and the code should also check that the returned value is not equal to `NULL`.

## Solution to Problem 3.47 (page 286)

- A. This corresponds to a range of around  $2^{13}$  addresses.
- B. A 128-byte nop sled would cover  $2^7$  addresses with each test, and so we would only require around  $2^6 = 64$  attempts.
- This example clearly shows that the degree of randomization in this version of Linux would provide only minimal deterrence against an overflow attack.

# Solution to Problem 3.48 (page 288)

This problem gives you another chance to see how x86-64 code manages the stack, and to also better understand how to defend against buffer overflow attacks.

- A. For the unprotected code, we can see that lines 4 and 5 compute the positions of `v` and `buf` to be at offsets 24 and 0 relative to `%rsp`. In the protected code, the canary is stored at offset 40 (line 4), while `v` and `buf` are at offsets 8 and 16 (lines 7 and 8).
- B. In the protected code, local variable `v` is positioned closer to the top of the stack than `buf`, and so an overrun of `buf` will not corrupt the value of `v`.

# Solution to Problem 3.49 (page 293)

This code combines many of the tricks we have seen for performing bit-level arithmetic. It requires careful study to make any sense of it.



- A. The `leaq` instruction of line 5 computes the value  $8n + 22$ , which is then rounded down to the nearest multiple of 16 by the `andq` instruction of line 6. The resulting value will be  $8n + 8$  when  $n$  is odd and  $8n + 16$  when  $n$  is even, and this value is subtracted from  $s_1$  to give  $s_2$ .
- B. The three instructions in this sequence round  $s_2$  up to the nearest multiple of 8. They make use of the combination of biasing and shifting that we saw for dividing by a power of 2 in [Section 2.3.7 !\[\]\(2824aab9645d9fab95bae27ff6828dab\_img.jpg\)](#).
- C. These two examples can be seen as the cases that minimize and maximize the values of  $e_1$  and  $e_2$ .
- D. We can see that  $s_2$  is computed in a way that preserves whatever offset  $s_1$  has with the nearest multiple of 16. We can also see that  $p$  will be aligned on a multiple of 8, as is recommended for an array of 8-byte elements.

# Solution to Problem 3.50 (page 300)

This exercise requires that you step through the code, paying careful attention to which conversion and data movement instructions are used. We can see the values being retrieved and converted as follows:

- The value at `dp` is retrieved, converted to an `int` (line 4), and then stored at `ip`. We can therefore infer that `val1` is `d`.
- The value at `ip` is retrieved, converted to a `float` (line 6), and then stored at `fp`. We can therefore infer that `val2` is `i`.
- The value of `l` is converted to a `double` (line 8) and stored at `dp`. We can therefore infer that `val3` is `l`.
- The value at `fp` is retrieved on line 3. The two instructions at lines 10-11 convert this to double precision as the value returned in register `%xmm0`. We can therefore infer that `val4` is `f`.

# Solution to Problem 3.51 (page 300)

These cases can be handled by selecting the appropriate entries from the tables in **Figures 3.47**  and **3.48** , or using one of the code sequences for converting between floating-point formats.

# Solution to Problem 3.52 (page 301)

The basic rules for mapping arguments to registers are fairly simple (although they become much more complex with more and other types of arguments [77]).

A. `double g1(double a, long b, float c, int d);`

Registers: `a` in `%xmm0`, `b` in `%rdi`, `c` in `%xmm1`, `d` in `%esi`

B. `double g2(int a, double *b, float *c, long d);`

Registers: `a` in `%edi`, `b` in `%rsi`, `c` in `%rdx`, `d` in `%rcx`

C. `double g3(double *a, double b, int c, float d);`

Registers: `a` in `%rdi`, `b` in `%xmm0`, `c` in `%esi`, `d` in `%xmm1`

D. `double g4(float a, int *b, float c, double d);`

Registers: `a` in `%xmm0`, `b` in `%rdi`, `c` in `%xmm1`, `d` in `%xmm2`



# Solution to Problem 3.53 (page 303)

We can see from the assembly code that there are two integer arguments, passed in registers `%rdi` and `%rsi`. Let us name these `i1` and `i2`. Similarly, there are two floating-point arguments, passed in registers `%xmm0` and `%xmm1`, which we name `f1` and `f2`.

We can then annotate the assembly code:

```

|
|
|   Refer to arguments as i1 (%rdi), i2 (%esi)
|   f1 (%xmm0), and f2 (%xmm1)
|
|   double funct1(arg1_t p, arg2_t q, arg3_t r, arg4_t s)
1   funct1:
2       vcvtsi2ssq    %rsi, %xmm2, %xmm2    Get i2 and
convert from long to float
3       vaddss %xmm0, %xmm2, %xmm0    Add f1 (type
float)
4       vcvtsi2ss    %edi, %xmm2, %xmm2    Get i1 and
convert from int to float
5       vdivss %xmm0, %xmm2, %xmm0    Compute i1 /
(i2 + f1)
6       vunpcklps    %xmm0, %xmm0, %xmm0
7       vcvtps2pd    %xmm0, %xmm0    Convert to
double
8       vsubsd %xmm1, %xmm0, %xmm0    Compute i1 /
(i2 + f1) - f2 (double)
9       ret

```

From this we see that the code computes the value  $i1/(i2+f1)-f2$ . We can also see that `i1` has type `int`, `i2` has type `long`, `f1` has type `float`, and `f2` has type `double`. The only ambiguity in matching arguments to the named values stems from the commutativity of multiplication—yielding two possible results:

```
|  
double funct1a(int p, float q, long r, double s);
```

```
double funct1b(int p, long q, float r, double s);
```

# Solution to Problem 3.54 (page 303)

This problem can readily be solved by stepping through the assembly code and determining what is computed on each step, as shown with the annotations below:

```
|
|
|   double funct2(double w, int x, float y, long z)
|       w in %xmm0, x in %edi, y in %xmm1, z in %rsi
1   funct2:
2       vcvtsi2ss    %edi, %xmm2, %xmm2    Convert x to
float
3       vmulss      %xmm1, %xmm2, %xmm1    Multiply by y
4       vunpcklps   %xmm1, %xmm1, %xmm1
5       vcvtps2pd   %xmm1, %xmm2          Convert x*y
to double
6       vcvtsi2sdq  %rsi, %xmm1, %xmm1    Convert z to
double
7       vdivsd      %xmm1, %xmm0, %xmm0    Compute w/z
8       vsubsd      %xmm0, %xmm2, %xmm0    Subtract from
x*y
9       ret          Return
```

We can conclude from this analysis that the function computes `y`

`* x = w/z.`

## Solution to Problem 3.55 (page 305)

This problem involves the same reasoning as was required to see that numbers declared at label `.LC2` encode 1.8, but with a simpler example.

We see that the two values are 0 and 1077936128 (`0x40400000`). From the high-order bytes, we can extract an exponent field of `0x404` (1028), from which we subtract a bias of 1023 to get an exponent of 5. Concatenating the fraction bits of the two values, we get a fraction field of 0, but with the implied leading value giving value 1.0. The constant is therefore  $1.0 \times 2^5 = 32.0$ .

# Solution to Problem 3.56 (page 305)

- A. We see here that the 16 bytes starting at address `.LC1` form a mask, where the low-order 8 bytes contain all ones, except for the most significant bit, which is the sign bit of a double-precision value. When we compute the AND of this mask with `%xmm0`, it will clear the sign bit of `x`, yielding the absolute value. In fact, we generated this code by defining `EXPR(x)` to be `fabs(x)`, where `fabs` is defined in `<math.h>`.
- B. We see that the `vxorpd` instruction sets the entire register to zero, and so this is a way to generate floating-point constant 0.0.
- C. We see that the 16 bytes starting at address `.LC2` form a mask with a single 1 bit, at the position of the sign bit for the low-order value in the XMM register. When we compute the EXCLUSIVE-OR of this mask with `%xmm0`, we change the sign of `x`, computing the expression `-x`.

# Solution to Problem 3.57 [↗](#)(page 308)

Again, we annotate the code, including dealing with the conditional branch:

```

double funct3(int *ap, double b, long c, float *dp)
ap in %rdi, b in %xmm0, c in %rsi, dp in %rdx
1  funct3:
2  vmovss    (%rdx), %xmm1    Get d = *dp
3  vcvtsi2sd (%rdi), %xmm2, %xmm2  Get a = *ap
and convert to double
4  vucomisd  %xmm2, %xmm0    Compare b:a
5  jbe      .L8              If <=, goto
lesseq
6  vcvtsi2ssq %rsi, %xmm0, %xmm0  Convert c to
float
7  vmulss    %xmm1, %xmm0, %xmm1  Multiply by d
8  vunpcklps %xmm1, %xmm1, %xmm1
9  vcvtps2pd %xmm1, %xmm0    Convert to
double
10  ret                      Return
11  .L8:                      lesseq:
12  vaddss    %xmm1, %xmm1, %xmm1  Compute d+d =
2.0 * d
13  vcvtsi2ssq %rsi, %xmm0, %xmm0  Convert c to
float
14  vaddss    %xmm1, %xmm0, %xmm0  Compute c +
2*d
15  vunpcklps %xmm0, %xmm0, %xmm0
16  vcvtps2pd %xmm0, %xmm0    Convert to
double
17  ret                      Return

```



From this, we can write the following code for `funct3`:

```
|  
double funct3(int *ap, double b, long c, float *dp) {  
    int a = *ap;  
    float d = *dp;  
    if (a < b)  
        return c*d;  
    else  
        return c+2*d;  
}
```

[OceanofPDF.com](http://OceanofPDF.com)

---

# Chapter 4 Processor Architecture

---

**4.1 The Y86-64 Instruction Set Architecture 355** 

**4.2 Logic Design and the Hardware Control Language HCL 372** 

**4.3 Sequential Y86-64 Implementations 384** 

**4.4 General Principles of Pipelining 412** 

**4.5 Pipelined Y86-64 Implementations 421** 

**4.6 Summary 470** 

**Bibliographic Notes 473** 

**Homework Problems 473** 

**Solutions to Practice Problems 480** 

*Modern microprocessors are among the most complex systems ever created by humans. A single silicon chip, roughly the size of a fingernail, can contain several high-performance processors, large cache memories, and the logic required to interface them to external devices. In terms of performance, the processors implemented on a single chip today dwarf the room-size supercomputers that cost over \$10 million just 20 years ago. Even the embedded processors found in everyday appliances such as cell phones, navigation systems, and programmable thermostats are far more powerful than the early developers of computers could ever have envisioned.*

*So far, we have only viewed computer systems down to the level of machine-language programs. We have seen that a processor must execute a sequence of instructions, where each instruction performs some primitive operation, such as adding two numbers. An instruction is encoded in binary form as a sequence of 1 or more bytes. The instructions supported by a particular processor and their byte-level encodings are known as its instruction set architecture (ISA). Different "families" of processors, such as Intel IA32 and x86-64,*

*IBM/Freescale Power, and the ARM processor family, have different ISAs. A program compiled for one type of machine will not run on another. On the other hand, there are many different models of processors within a single family. Each manufacturer produces processors of ever-growing performance and complexity, but the different models remain compatible at the ISA level. Popular families, such as x86-64, have processors supplied by multiple manufacturers. Thus, the ISA provides a conceptual layer of abstraction between compiler writers, who need only know what instructions are permitted and how they are encoded, and processor designers, who must build machines that execute those instructions.*

*In this chapter, we take a brief look at the design of processor hardware. We study the way a hardware system can execute the instructions of a particular ISA. This view will give you a better understanding of how computers work and the technological challenges faced by computer manufacturers. One important concept is that the actual way a modern processor operates can be quite different from the model of computation implied by the ISA. The ISA model would seem to imply sequential instruction*

*execution, where each instruction is fetched and executed to completion before the next one begins. By executing different parts of multiple instructions simultaneously, the processor can achieve higher performance than if it executed just one instruction at a time. Special mechanisms are used to make sure the processor computes the same results as it would with sequential execution. This idea of using clever tricks to improve performance while maintaining the functionality of a simpler and more abstract model is well known in computer science. Examples include the use of caching in Web browsers and information retrieval data structures such as balanced binary trees and hash tables.*

*Chances are you will never design your own processor. This is a task for experts working at fewer than 100 companies worldwide. Why, then, should you learn about processor design?*

- ***It is intellectually interesting and important.*** *There is an intrinsic value in learning how things work. It is especially interesting to learn the inner workings of*

## *Aside The progress of computer technology*

*To get a sense of how much computer technology has improved over the past four decades, consider the following two processors.*

*The first Cray 1 supercomputer was delivered to Los Alamos National Laboratory in 1976. It was the fastest computer in the world, able to perform as many as 250 million arithmetic operations per second. It came with 8 megabytes of random access memory, the maximum configuration allowed by the hardware. The machine was also very large—it weighed 5,000 kg, consumed 115 kilowatts, and cost \$9 million. In total, around 80 of them were manufactured.*

*The Apple ARM A7 microprocessor chip, introduced in 2013 to power the iPhone 5S, contains two CPUs, each of which can perform several billion*

*arithmetic operations per second, and 1 gigabyte of random access memory. The entire phone weighs just 112 grams, consumes around 1 watt, and costs less than \$800. Over 9 million units were sold in the first weekend of its introduction. In addition to being a powerful computer, it can be used to take pictures, to place phone calls, and to provide driving directions, features never considered for the Cray 1.*

*These two systems, spaced just 37 years apart, demonstrate the tremendous progress of semiconductor technology. Whereas the Cray 1's CPU was constructed using around 100,000 semiconductor chips, each containing less than 20 transistors, the Apple A7 has over 1 billion transistors on its single chip. The Cray 1's 8-megabyte memory required 8,192 chips, whereas the iPhone's gigabyte memory is contained in a single chip.*

*a system that is such a part of the daily lives of computer scientists and engineers and yet remains a mystery to many. Processor*



*design embodies many of the principles of good engineering practice. It requires creating a simple and regular structure to perform a complex task.*

- ***Understanding how the processor works aids in understanding how the overall computer system works.*** In **Chapter 6**, we will look at the memory system and the techniques used to create an image of a very large memory with a very fast access time. Seeing the processor side of the processor-memory interface will make this presentation more complete.
- ***Although few people design processors, many design hardware systems that contain processors.*** This has become commonplace as processors are embedded into real-world systems such as automobiles and appliances. Embedded-system designers must understand how processors work, because these systems are generally designed and programmed at a lower level of abstraction than is the case for desktop and server-based systems.
- ***You just might work on a processor design.*** Although the number of companies producing microprocessors is small, the design teams working on those processors

*are already large and growing. There can be over 1,000 people involved in the different aspects of a major processor design.*

*In this chapter, we start by defining a simple instruction set that we use as a running example for our processor implementations. We call this the "Y86-64" instruction set, because it was inspired by the x86-64 instruction set. Compared with x86-64, the Y86-64 instruction set has fewer data types, instructions, and addressing modes. It also has a simple byte-level encoding, making the machine code less compact than the comparable x86-64 code, but also much easier to design the CPU's decoding logic. Even though the Y86-64 instruction set is very simple, it is sufficiently complete to allow us to write programs manipulating integer data. Designing a processor to implement Y86-64 requires us to deal with many of the challenges faced by processor designers.*

*We then provide some background on digital hardware design. We describe the basic building blocks used in a processor and how they are connected together and operated. This presentation builds on our discussion of Boolean*

*algebra and bit-level operations from **Chapter 2**. We also introduce a simple language, HCL (for "hardware control language"), to describe the control portions of hardware systems. We will later use this language to describe our processor designs. Even if you already have some background in logic design, read this section to understand our particular notation.*

*As a first step in designing a processor, we present a functionally correct, but somewhat impractical, Y86-64 processor based on sequential operation. This processor executes a complete Y86-64 instruction on every clock cycle. The clock must run slowly enough to allow an entire series of actions to complete within one cycle. Such a processor could be implemented, but its performance would be well below what could be achieved for this much hardware.*

*With the sequential design as a basis, we then apply a series of transformations to create a pipelined processor. This processor breaks the execution of each instruction into five steps, each of which is handled by a separate section or stage of the hardware. Instructions progress*

*through the stages of the pipeline, with one instruction entering the pipeline on each clock cycle. As a result, the processor can be executing the different steps of up to five instructions simultaneously. Making this processor preserve the sequential behavior of the Y86-64 ISA requires handling a variety of hazard conditions, where the location or operands of one instruction depend on those of other instructions that are still in the pipeline.*

*We have devised a variety of tools for studying and experimenting with our processor designs. These include an assembler for Y86-64, a simulator for running Y86-64 programs on your machine, and simulators for two sequential and one pipelined processor design. The control logic for these designs is described by files in HCL notation. By editing these files and recompiling the simulator, you can alter and extend the simulator's behavior. A number of exercises are provided that involve implementing new instructions and modifying how the machine processes instructions. Testing code is provided to help you evaluate the correctness of your modifications. These exercises will greatly aid your understanding of the material and will give you an appreciation for*

*the many different design alternatives faced by processor designers.*

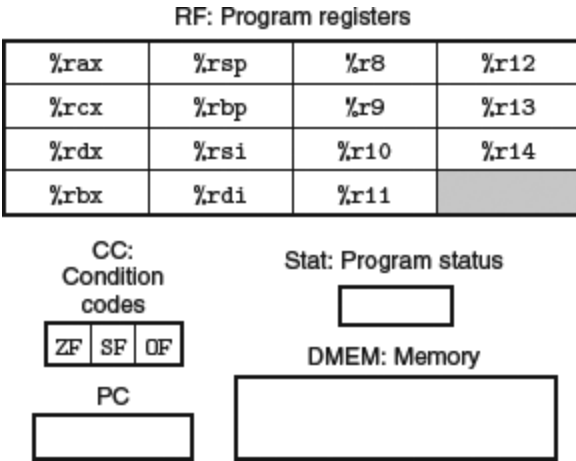
*Web Aside ARCH:VLOG on page 467 presents a representation of our pipelined Y86-64 processor in the Verilog hardware description language. This involves creating modules for the basic hardware building blocks and for the overall processor structure. We automatically translate the HCL description of the control logic into Verilog. By first debugging the HCL description with our simulators, we eliminate many of the tricky bugs that would otherwise show up in the hardware design. Given a Verilog description, there are commercial and open-source tools to support simulation and logic synthesis, generating actual circuit designs for the microprocessors. So, although much of the effort we expend here is to create pictorial and textual descriptions of a system, much as one would when writing software, the fact that these designs can be automatically synthesized demonstrates that we are indeed creating a system that can be realized as hardware.*

# 4.1 The Y86-64 Instruction Set Architecture

Defining an instruction set architecture, such as Y86-64, includes defining the different components of its state, the set of instructions and their encodings, a set of programming conventions, and the handling of exceptional events.

## 4.1.1 Programmer-Visible State

As [Figure 4.1](#) illustrates, each instruction in a Y86-64 program can read and modify some part of the processor state. This is referred to as the *programmer-visible* state, where the "programmer" in this case is either someone writing programs in assembly code or a compiler generating machine-level code. We will see in our processor implementations that we do not need to represent and organize this state in exactly the manner implied by the ISA, as long as we can make sure that machine-level programs appear to have access to the programmer-visible state. The state for Y86-64 is similar to that for x86-64. There are 15 *program registers*: `%rax`, `%rcx`, `%rdx`, `%rbx`, `%rsp`, `%rbp`, `%rsi`, `%rdi`, and `%r8` through `%r14`. (We omit the x86-64 register `%r15` to simplify the instruction encoding.) Each of these stores a 64-bit word. Register `%rsp` is used as a stack pointer by the `push`, `pop`, `call`, and `return` instructions. Otherwise, the registers have no fixed meanings or values. There are three single-bit *condition codes*, `ZF`, `SF`, and `OF`, storing information




**Figure 4.1 Y86-64 programmer-visible state.**

As with x86-64, programs for Y86-64 access and modify the program registers, the condition codes, the program counter (PC), and the memory. The status code indicates whether the program is running normally or some special event has occurred.



about the effect of the most recent arithmetic or logical instruction. The program counter (PC) holds the address of the instruction currently being executed.

The *memory* is conceptually a large array of bytes, holding both program and data. Y86-64 programs reference memory locations using *virtual addresses*. A combination of hardware and operating system software translates these into the actual, or *physical*, addresses indicating where the values are actually stored in memory. We will study virtual memory in more detail in [Chapter 9](#). For now, we can think of the virtual memory system as providing Y86-64 programs with an image of a monolithic byte array.



A final part of the program state is a status code `Stat`, indicating the overall state of program execution. It will indicate either normal operation or that some sort of *exception* has occurred, such as when an instruction attempts to read from an invalid memory address. The possible status codes and the handling of exceptions is described in [Section 4.1.4](#) .

## 4.1.2 Y86-64 Instructions


**Figure 4.2**  gives a concise description of the individual instructions in the Y86-64 ISA. We use this instruction set as a target for our processor implementations. The set of Y86-64 instructions is largely a subset of the x86-64 instruction set. It includes only 8-byte integer operations, has fewer addressing modes, and includes a smaller set of operations. Since we only use 8-byte data, we can refer to these as "words" without any ambiguity. In this figure, we show the assembly-code representation of the instructions on the left and the byte encodings on the right. **Figure 4.3**  shows further details of some of the instructions. The assembly-code format is similar to the ATT format for x86-64.

Here are some details about the Y86-64 instructions.

- The x86-64 `movq` instruction is split into four different instructions: `irmovq`, `rrmovq`, `mrmovq`, and `rmmovq`, explicitly indicating the form of the source and destination. The source is either immediate (`i`), register (`r`), or memory (`m`). It is designated by the first character in the instruction name. The destination is either register (`r`) or memory (`m`). It is designated by the second character in the instruction name. Explicitly identifying the four types of data transfer will prove helpful when we decide how to implement them.

The memory references for the two memory movement instructions have a simple base and displacement format. We do not support the second index register or any scaling of a register's value in the address computation.

As with x86-64, we do not allow direct transfers from one memory location to another. In addition, we do not allow a transfer of immediate data to memory.

- There are four integer operation instructions, shown in **Figure 4.2**  as `OPq`. These are `addq`, `subq`, `andq`, and `xorq`. They operate only on register data, whereas x86-64 also allows operations on memory data. These instructions set the three condition codes `ZF`, `SF`, and `OF` (zero, sign, and overflow).

Byte	0	1	2	3	4	5	6	7	8	9
halt	0	0								
nop	1	0								
rirmovq rA, rB	2	0	rA	rB						
irmovq V, rB	3	0	F	rB	V					
rmmovq rA, D(rB)	4	0	rA	rB	D					
mrmovq D(rB), rA	5	0	rA	rB	D					
OPq rA, rB	6	fn	rA	rB						
jXX Dest	7	fn	Dest							
cmovXX rA, rB	2	fn	rA	rB						

**Figure 4.2 Y86-64 instruction set.**

Instruction encodings range between 1 and 10 bytes. An instruction consists of a 1-byte instruction specifier, possibly a 1 - byte register specifier, and possibly an 8-byte constant word. Field `fn` specifies a particular integer operation (`OPq`), data movement condition (`cmovXX`), or branch condition (`jXX`). All numeric values are shown in hexadecimal.

- The seven jump instructions (shown in [Figure 4.2](#) as `jXX`) are `jmp`, `jle`, `j1`, `je`, `jne`, `jge`, and `jpg`. Branches are taken according to the type of branch and the settings of the condition codes. The branch conditions are the same as with x86-64 ([Figure 3.15](#)).
- There are six conditional move instructions (shown in [Figure 4.2](#) as `cmovXX`): `cmovle`, `cmovl`, `cmove`, `cmovne`, `cmovge`, and `cmovg`. These have the same format as the register-register move

instruction `rrmovq`, but the destination register is updated only if the condition codes satisfy the required constraints.

- The call instruction pushes the return address on the stack and jumps to the destination address. The `ret` instruction returns from such a call.
- The `pushq` and `popq` instructions implement push and pop, just as they do in x86-64.
- The `halt` instruction stops instruction execution. x86-64 has a comparable instruction, called `hlt`. x86-64 application programs are not permitted to use this instruction, since it causes the entire system to suspend operation. For Y86-64, executing the `halt` instruction causes the processor to stop, with the status code set to `HLT`. (See [Section 4.1.4](#).)

## 4.1.3 Instruction Encoding

**Figure 4.2** also shows the byte-level encoding of the instructions. Each instruction requires between 1 and 10 bytes, depending on which fields are required. Every instruction has an initial byte identifying the instruction type. This byte is split into two 4-bit parts: the high-order, or *code*, part, and the low-order, or *function*, part. As can be seen in **Figure 4.2**, code values range from `0` to `0xB`. The function values are significant only for the cases where a group of related instructions share a common code. These are given in **Figure 4.3**, showing the specific encodings of the integer operation, branch, and conditional move instructions. Observe that `rrmovq` has the same instruction code as the conditional moves. It can be viewed as an "unconditional move" just as the `jmp` instruction is an unconditional jump, both having function code `0`.

As shown in **Figure 4.4**, each of the 15 program registers has an associated *register identifier* (ID) ranging from `0` to `0xE`. The numbering of registers in Y86-64 matches what is used in x86-64. The program registers are stored within the CPU in a *register file*, a small random access memory where the register IDs serve as addresses. ID value `0xF` is used in the instruction encodings and within our hardware designs when we need to indicate that no register should be accessed.

Some instructions are just 1 byte long, but those that require operands have longer encodings. First, there can be an additional *register specifier byte*, specifying either one or two registers. These register fields are called rA and rB in [Figure 4.2](#). As the assembly-code versions of the instructions show, they can specify the registers used for data sources and destinations, as well as the base register used in an address computation, depending on the instruction type. Instructions that have no register operands, such as branches and call, do not have a register specifier byte. Those that require just one register operand (`irmovq`, `pushq`, and `popq`) have

Operations	Branches	Moves										
addq <table border="1"><tr><td>6</td><td>0</td></tr></table>	6	0	jmp <table border="1"><tr><td>7</td><td>0</td></tr></table> jne <table border="1"><tr><td>7</td><td>4</td></tr></table>	7	0	7	4	rrmovq <table border="1"><tr><td>2</td><td>0</td></tr></table> cmovne <table border="1"><tr><td>2</td><td>4</td></tr></table>	2	0	2	4
6	0											
7	0											
7	4											
2	0											
2	4											
subq <table border="1"><tr><td>6</td><td>1</td></tr></table>	6	1	jle <table border="1"><tr><td>7</td><td>1</td></tr></table> jge <table border="1"><tr><td>7</td><td>5</td></tr></table>	7	1	7	5	cmovle <table border="1"><tr><td>2</td><td>1</td></tr></table> cmovge <table border="1"><tr><td>2</td><td>5</td></tr></table>	2	1	2	5
6	1											
7	1											
7	5											
2	1											
2	5											
andq <table border="1"><tr><td>6</td><td>2</td></tr></table>	6	2	jl <table border="1"><tr><td>7</td><td>2</td></tr></table> jg <table border="1"><tr><td>7</td><td>6</td></tr></table>	7	2	7	6	cmovl <table border="1"><tr><td>2</td><td>2</td></tr></table> cmovg <table border="1"><tr><td>2</td><td>6</td></tr></table>	2	2	2	6
6	2											
7	2											
7	6											
2	2											
2	6											
xorq <table border="1"><tr><td>6</td><td>3</td></tr></table>	6	3	je <table border="1"><tr><td>7</td><td>3</td></tr></table>	7	3	cmovle <table border="1"><tr><td>2</td><td>3</td></tr></table>	2	3				
6	3											
7	3											
2	3											

**Figure 4.3 Function codes for Y86-64 instruction set.**

The code specifies a particular integer operation, branch condition, or data transfer condition. These instructions are shown as `OPq`, `jXX`, and `cmovXX` in [Figure 4.2](#).

### Figure 4.4 Y86-64 program register identifiers.

Each of the 15 program registers has an associated identifier (ID) ranging from 0 to 0xE. ID 0xF in a register field of an instruction indicates the absence of a register operand.

the other register specifier set to value 0xF. This convention will prove useful in our processor implementation.

Some instructions require an additional 8-byte *constant word*. This word can serve as the immediate data for `irmovq`, the displacement for `rmmovq` and `mrmmovq` address specifiers, and the destination of branches and calls. Note that branch and call destinations are given as absolute addresses, rather than using the PC-relative addressing seen in x86-64. Processors use PC-relative addressing to give more compact encodings of branch instructions and to allow code to be shifted from one part of memory to another without the need to update all of the branch target addresses. Since we are more concerned with simplicity in our presentation, we use absolute addressing. As with x86-64, all integers have a little-endian encoding. When the instruction is written in disassembled form, these bytes appear in reverse order.

As an example, let us generate the byte encoding of the instruction `rmmovq %rsp, 0x123456789abcd(%rdx)` in hexadecimal. From [Figure 4.2](#), we can see that `rmmovq` has initial byte 40. We can also see that source register `%rsp` should be encoded in the rA field, and base register `%rdx` should be encoded in the rB field. Using the register



numbers in [Figure 4.4](#), we get a register specifier byte of 42. Finally, the displacement is encoded in the 8-byte constant word. We first pad `0x123456789abcd` with leading zeros to fill out 8 bytes, giving a byte sequence of `00 0123 45 67 89 ab cd`. We write this in byte-reversed order as `cd ab 89 67 45 23 01 00`. Combining these, we get an instruction encoding of `4042cdab896745230100`.

One important property of any instruction set is that the byte encodings must have a unique interpretation. An arbitrary sequence of bytes either encodes a unique instruction sequence or is not a legal byte sequence. This property holds for Y86-64, because every instruction has a unique combination of code and function in its initial byte, and given this byte, we can determine the length and meaning of any additional bytes. This property ensures that a processor can execute an object-code program without any ambiguity about the meaning of the code. Even if the code is embedded within other bytes in the program, we can readily determine

## Aside Comparing x86-64 to Y86-64 instruction encodings

Compared with the instruction encodings used in x86-64, the encoding of Y86-64 is much simpler but also less compact. The register fields occur only in fixed positions in all Y86-64 instructions, whereas they are packed into various positions in the different x86-64 instructions. An x86-64 instruction can encode constant values in 1, 2, 4, or 8 bytes, whereas Y86-64 always requires 8 bytes.

the instruction sequence as long as we start from the first byte in the sequence. On the other hand, if we do not know the starting position of a code sequence, we cannot reliably determine how to split the sequence into individual instructions. This causes problems for disassemblers and other tools that attempt to extract machine-level programs directly from object-code byte sequences.

## Practice Problem 4.1 (solution page 480)

Determine the byte encoding of the Y86-64 instruction sequence that follows. The line `.pos 0x100` indicates that the starting address of the object code should be `0x100`.

```
.pos 0x100 # Start code at address 0x100
    irmovq $15,%rbx
    rrmovq %rbx,%rcx
loop:
    rmmovq %rcx, -3(%rbx)
    addq %rbx, 7,rcx
    jmp loop
```

## Practice Problem 4.2 (solution page 481)

For each byte sequence listed, determine the Y86-64 instruction sequence it encodes. If there is some invalid byte in the sequence, show the instruction sequence up to that point and indicate where the invalid value occurs. For each sequence, we show the starting address, then a colon, and then the byte sequence.

- A. `0x100: 30f3fcffffffffffffffff40630008000000000000`
- B. `0x200: a06f800c02000000000000000030f30a00000000000000`
- C. `0x300: 50540700000000000000000010f0b01f`
- D. `0x400: 61137300040000000000000000`
- E. `0x500: 6362a0f0`

# Aside RISC and CISC instruction sets

x86-64 is sometimes labeled as a "complex instruction set computer" (CISC—pronounced "sisk"), and is deemed to be the opposite of ISAs that are classified as "reduced instruction set computers" (RISC—pronounced "risk"). Historically, CISC machines came first, having evolved from the earliest computers. By the early 1980s, instruction sets for mainframe and minicomputers had grown quite large, as machine designers incorporated new instructions to support high-level tasks, such as manipulating circular buffers, performing decimal arithmetic, and evaluating polynomials. The first microprocessors appeared in the early 1970s and had limited instruction sets, because the integrated-circuit technology then posed severe constraints on what could be implemented on a single chip. Microprocessors evolved quickly and, by the early 1980s, were following the same path of increasing instruction set complexity that had been the case for mainframes and minicomputers. The x86 family took this path, evolving into IA32, and more recently into x86-64. The x86 line continues to evolve as new classes of instructions are added based on the needs of emerging applications.

The RISC design philosophy developed in the early 1980s as an alternative to these trends. A group of hardware and compiler experts at IBM, strongly influenced by the ideas of IBM researcher John Cocke, recognized that they could

generate efficient code for a much simpler form of instruction set. In fact, many of the high-level instructions that were being added to instruction sets were very difficult to generate with a compiler and were seldom used. A simpler instruction set could be implemented with much less hardware and could be organized in an efficient pipeline structure, similar to those described later in this chapter. IBM did not commercialize this idea until many years later, when it developed the Power and PowerPC ISAs.

The RISC concept was further developed by Professors David Patterson, of the University of California at Berkeley, and John Hennessy, of Stanford University. Patterson gave the name RISC to this new class of machines, and CISC to the existing class, since there had previously been no need to have a special designation for a nearly universal form of instruction set.

When comparing CISC with the original RISC instruction sets, we find the following general characteristics:

The Y86-64 instruction set includes attributes of both CISC and RISC instruction sets. On the CISC side, it has condition codes and variable-length instructions, and it uses the stack to store return addresses. On the RISC side, it uses a load/store architecture and a regular instruction encoding, and it passes procedure arguments through registers. It can be viewed as taking a CISC instruction set (x86) and simplifying it by applying some of the principles of RISC.

# Aside The RISC versus CISC controversy

Through the 1980s, battles raged in the computer architecture community regarding the merits of RISC versus CISC instruction sets. Proponents of RISC claimed they could get more computing power for a given amount of hardware through a combination of streamlined instruction set design, advanced compiler technology, and pipelined processor implementation. CISC proponents countered that fewer CISC instructions were required to perform a given task, and so their machines could achieve higher overall performance.

Major companies introduced RISC processor lines, including Sun Microsystems (SPARC), IBM and Motorola (PowerPC), and Digital Equipment Corporation (Alpha). A British company, Acorn Computers Ltd., developed its own architecture, ARM (originally an acronym for "Acorn RISC machine"), which has become widely used in embedded applications, such as cell phones.

In the early 1990s, the debate diminished as it became clear that neither RISC nor CISC in their purest forms were better than designs that incorporated the best ideas of both. RISC machines evolved and introduced more instructions, many of which take multiple cycles to execute. RISC machines today have hundreds of instructions in their repertoire, hardly fitting the name "reduced instruction set machine." The idea of



exposing implementation artifacts to machine-level programs proved to be shortsighted. As new processor models were developed using more advanced hardware structures, many of these artifacts became irrelevant, but they still remained part of the instruction set. Still, the core of RISC design is an instruction set that is well suited to execution on a pipelined machine.

More recent CISC machines also take advantage of high-performance pipeline structures. As we will discuss in [Section 5.7](#), they fetch the CISC instructions and dynamically translate them into a sequence of simpler, RISC-like operations. For example, an instruction that adds a register to memory is translated into three operations: one to read the original memory value, one to perform the addition, and a third to write the sum to memory. Since the dynamic translation can generally be performed well in advance of the actual instruction execution, the processor can sustain a very high execution rate.

Marketing issues, apart from technological ones, have also played a major role in determining the success of different instruction sets. By maintaining compatibility with its existing processors, Intel with x86 made it easy to keep moving from one generation of processor to the next. As integrated-circuit technology improved, Intel and other x86 processor manufacturers could overcome the inefficiencies created by the original 8086 instruction set design, using RISC techniques to produce performance comparable to the best

RISC machines. As we saw in [Section 3.1](#), the evolution of IA32 into x86-64 provided an opportunity to incorporate several features of RISC into the x86 family. In the areas of desktop, laptop, and server-based computing, x86 has achieved near total domination.

RISC processors have done very well in the market for *embedded processors*, controlling such systems as cellular telephones, automobile brakes, and Internet appliances. In these applications, saving on cost and power is more important than maintaining backward compatibility. In terms of the number of processors sold, this is a very large and growing market.

## 4.1.4 Y86-64 Exceptions

The programmer-visible state for Y86-64 ([Figure 4.1](#)) includes a status code `Stat` describing the overall state of the executing program. The possible values for this code are shown in [Figure 4.5](#). Code value 1, named `AOK`, indicates that the program

### Figure 4.5 Y86-64 status codes.


In our design, the processor halts for any code other than `AOK`.

is executing normally, while the other codes indicate that some type of *exception* has occurred. Code 2, named `HLT`, indicates that the processor has executed a `halt` instruction. Code 3, named `ADR`, indicates that the processor attempted to read from or write to an invalid memory address, either while fetching an instruction or while reading or writing data. We limit the maximum address (the exact limit varies by implementation), and any access to an address beyond this limit will trigger an `ADR` exception. Code 4, named `INS`, indicates that an invalid instruction code has been encountered.

For Y86-64, we will simply have the processor stop executing instructions when it encounters any of the exceptions listed. In a more complete design, the processor would typically invoke an *exception handler*, a procedure designated to handle the specific type of exception encountered. As described in [Chapter 8](#),

exception handlers can be configured to have different effects, such as aborting the program or invoking a user-defined *signal handler*.

## 4.1.5 Y86-64 Programs

**Figure 4.6**  shows x86-64 and Y86-64 assembly code for the following C function:

```
1   long sum(long *start, long count)
2   {
3   long sum = 0;
4   while (count) {
5   sum += *start;
6   start++;
7   count--;
8   }
9   return sum;
10 }
```

The x86-64 code was generated by the `gcc` compiler. The Y86-64 code is similar, but with the following differences:

- The Y86-64 code loads constants into registers (lines 2-3), since it cannot use immediate data in arithmetic instructions.

## x86-64 code

```
long sum(long * start, long count)  
start in %rdi, count in %rsi  
1 sum:  
2 movl $0, %eax sum = 0  
3 jmp .L2 Goto test  
4 .L3: loop:  
5 addq (%rdi), %rax Add *start to sum  
6 addq $8, %rdi start ++  
7 subq $1, %rsi count--  
8 .L2: test:  
9 testq %rsi, %rsi Test sum  
10 jne .L3 If != 0, goto loop  
11 rep; ret Return
```

## Y86-64 code

```

    long sum(long * start, long count)
    start in %rdi, count in %rsi
1   sum:
2   irmovq $8,% r8           Constant 8
3   irmovq $1,%r9           Constant 1
4   xorq   %rax,%rax        sum = 0
5   andq   %rsi,%rsi        Set CC
6   jmp    test             Go to test
7   loop:
8   mrmovq (%rdi),%r10      Get *start
9   addq   %r10,%rax        Add to sum
10  addq   %r8,%rdi         start++
11  subq   %r9,%rsi        count--. Set CC
12  test:
13  jne    loop             Stop when 0
14  ret                    Return


```

### Figure 4.6 Comparison of Y86-64 and x86-64 assembly programs.

The sum function computes the sum of an integer array. The Y86-64 code follows the same general pattern as the x86-64 code.

- The Y86-64 code requires two instructions (lines 8-9) to read a value from memory and add it to a register, whereas the x86-64 code can do this with a single `addq` instruction (line 5).

- Our hand-coded Y86-64 implementation takes advantage of the property that the `subq` instruction (line 11) also sets the condition codes, and so the `testq` instruction of the gcc-generated code (line 9) is not required. For this to work, though, the Y86-64 code must set the condition codes prior to entering the loop with an `andq` instruction (line 5).

**Figure 4.7**  shows an example of a complete program file written in Y86-64 assembly code. The program contains both data and instructions. Directives indicate where to place code or data and how to align it. The program specifies issues such as stack placement, data initialization, program initialization, and program termination.

In this program, words beginning with ``.'` are *assembler directives* telling the assembler to adjust the address at which it is generating code or to insert some words of data. The directive `.pos 0` (line 2) indicates that the assembler should begin generating code starting at address 0. This is the starting address for all Y86-64 programs. The next instruction (line 3) initializes the stack pointer. We can see that the label `stack` is declared at the end of the program (line 40), to indicate address `0x200` using a `.pos` directive (line 39). Our stack will therefore start at this address and grow toward lower addresses. We must ensure that the stack does not grow so large that it overwrites the code or other program data.



Lines 8 to 13 of the program declare an array of four words, having the values



```
0x000d000d000d000d, 0x00c000c000c000c0,  
0x0b000b000b000b00, 0xa000a000a000a000
```

The label array denotes the start of this array, and is aligned on an 8-byte boundary (using the `.align` directive). Lines 16 to 19 show a "main" procedure that calls the function `sum` on the four-word array and then halts.

As this example shows, since our only tool for creating Y86-64 code is an assembler, the programmer must perform tasks we ordinarily delegate to the compiler, linker, and run-time system. Fortunately, we only do this for small programs, for which simple mechanisms suffice.

**Figure 4.8**  shows the result of assembling the code shown in **Figure 4.7**  by an assembler we call `YAS`. The assembler output is in ASCII format to make it more readable. On lines of the assembly file that contain instructions or data, the object code contains an address, followed by the values of between 1 and 10 bytes.

We have implemented an *instruction set simulator* we call `YIS`, the purpose of which is to model the execution of a Y86-64 machine-code program without attempting to model the behavior of any specific processor implementation. This form of simulation is useful

for debugging programs before actual hardware is available, and for checking the result of either simulating the hardware or running

```

1      # Execution begins at address 0
2      .pos 0
3      irmovq stack, %rsp # Set up stack pointer
4      call main          # Execute main program
5      halt              # Terminate program
6
7      # Array of 4 elements
8      .align 8
9      array :
10     .quad 0x000d000d000d
11     .quad 0x00c000c000c0
12     .quad 0x0b000b000b00
13     .quad 0xa000a000a000
14
15     main:
16     irmovq array,%rdi
17     irmovq $4,%rsi
18     call sum          # sum(array, 4)
19     ret
20
21     # long sum(long *start, long count)
22     # start in %rdi, count in %rsi
23     sum:
24     irmovq $8,%r8     # Constant 8
25     irmovq $1,%r9     # Constant 1
26     xorq %rax,%rax    # sum = 0
27     andq %rsi,%rsi    # Set CC

```

```

28      jmp test          # Goto test
29      loop :
30      mrmovq (%rdi),%r10 # Get *start
31      addq %r10,%rax    # Add to sum
32      addq %r8,%rdi    # start++
33      subq %r9,%rsi    # count--. Set CC
34      test:
35      jne loop         # Stop when 0
36      ret              # Return
37
38      # Stack starts here and grows to lower addresses
39      .pos 0x200
40      stack:

```

**Figure 4.7 Sample program written in Y86-64 assembly code.** The sum function is called to compute the sum of a four-element array.

```

| # Execution begins at
address 0
0x000: | .pos 0
0x000: 30f40002000000000000 | irmovq stack, %rsp #
Set up stack pointer
0x00a: 80380000000000000000 | call main # Execute
main program
0x013: 00 | halt # Terminate
program
| # Array of 4 elements
0x018: | .align 8
0x018: | array:
0x018: 0d000d000d000000 | .quad 0x000d000d000d
0x020: c000c000c0000000 | .quad 0x00c000c000c0
0x028: 000b000b000b0000 | .quad 0x0b000b000b00
0x030: 00a000a000a00000 | .quad 0xa000a000a000
0x038: | main:
0x038: 30f71800000000000000 | irmovq array,%rdi
0x042: 30f60400000000000000 | irmovq $4,%rsi
0x04c: 80560000000000000000 | call sum # sum(array,
4)
0x055: 90 | ret
| # long sum(long
*start, long count)
| # start in %rdi, count
in %rsi
0x056 : | sum :
0x056: 30f80800000000000000 | irmovq $8,%r8 #

```

```

Constant 8
0x060: 30f901000000000000000000 | irmovq $1,%r9 #
Constant 1
0x06a: 6300 | xorq %rax,7, rax # sum
= 0
0x06c: 6266 | andq %rsi, %rsi # Set
CC
0x06e: 708700000000000000000000 | jmp test # Goto test
0x077: | loop:
0x077: 50a700000000000000000000 | mrmovq (%rdi),%10 #
Get *start
0x081: 60a0 | addq %r10,%rax # Add
to sum
0x083: 6087 | addq %r8,%rdi #
start++
0x085: 6196 | subq %r9,%rsi # count-
-. Set CC
0x087: | test:
0x087: 747700000000000000000000 | jne loop # Stop when 0
0x090: 90 | ret # Return
| # Stack starts here
and grows to lower addresses
0x200: | .pos 0x200
0x200: | stack:

```

**Figure 4.8** Output of `yas` assembler.

Each line includes a hexadecimal address and between 1 and 10 bytes of object code.

the program on the hardware itself. Running on our sample object code, `vis` generates the following output:

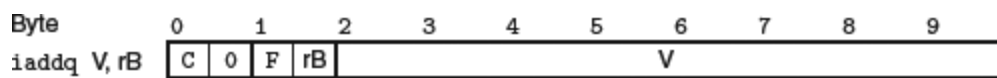
```
Stopped in 34 steps at PC = 0x13. Status `HLT', CC Z=1 S=0 O=0
Changes to registers:
%rax:  0x0000000000000000      0x0000abcdabcdabcd
%rsp:  0x0000000000000000      0x0000000000000200
%rdi:  0x0000000000000000      0x0000000000000038
%r8:   0x0000000000000000      0x0000000000000008
%r9:   0x0000000000000000      0x0000000000000001
%r10:  0x0000000000000000      0x0000a000a000a000
Changes to memory:
0x01f0: 0x0000000000000000      0x0000000000000055
0x01f8: 0x0000000000000000      0x0000000000000013
```

The first line of the simulation output summarizes the execution and the resulting values of the PC and program status. In printing register and memory values, it only prints out words that change during simulation, either in registers or in memory. The original values (here they are all zero) are shown on the left, and the final values are shown on the right. We can see in this output that register `%rax` contains `0xabcdabcdabcdabcd`, the sum of the 4-element array passed

to procedure `sum`. In addition, we can see that the stack, which starts at address `0x200` and grows toward lower addresses, has been used, causing changes to words of memory at addresses `0x1f0-0x1f8`. The maximum address for executable code is `0x090`, and so the pushing and popping of values on the stack did not corrupt the executable code.

## Practice Problem 4.3 (solution page 482)

One common pattern in machine-level programs is to add a constant value to a register. With the Y86-64 instructions presented thus far, this requires first using an `irmovq` instruction to set a register to the constant, and then an `addq` instruction to add this value to the destination register. Suppose we want to add a new instruction `iaddq` with the following format:



This instruction adds the constant value `V` to register `rB`.

Rewrite the Y86-64 `sum` function of [Figure 4.6](#) to make use of the `iaddq` instruction. In the original version, we dedicated registers `%r8` and `%r9` to hold constant values. Now, we can avoid using those registers altogether.




## Practice Problem 4.4 (solution page [482](#))

Write Y86-64 code to implement a recursive sum function `rsum`, based on the following C code:

```
long rsum(long *start, long count)
{
    if (count <= 0)
        return 0;
    return *start + rsum(start+1, count-1);
}
```

Use the same argument passing and register saving conventions as x86-64 code does. You might find it helpful to compile the C code on an x86-64 machine and then translate the instructions to Y86-64.

## Practice Problem 4.5 (solution page [483](#))

Modify the Y86-64 code for the sum function ([Figure 4.6](#) ) to implement a function `absSum` that computes the sum of absolute values of an array. Use a *conditional jump* instruction within your inner loop.

## *Practice Problem 4.6 (solution page [483](#))*

Modify the Y86-64 code for the `sum` function ([Figure 4.6](#)) to implement a function `absSum` that computes the sum of absolute values of an array. Use a *conditional move* instruction within your inner loop.

## 4.1.6 Some Y86-64 Instruction Details

Most Y86-64 instructions transform the program state in a straightforward manner, and so defining the intended effect of each instruction is not difficult. Two unusual instruction combinations, however, require special attention.

The `pushq` instruction both decrements the stack pointer by 8 and writes a register value to memory. It is therefore not totally clear what the processor should do when executing the instruction `pushq %rsp`, since the register being pushed is being changed by the same instruction. Two different conventions are possible: (1) push the original value of `%rsp`, or (2) push the decremented value of `%rsp`.

For the Y86-64 processor, let us adopt the same convention as is used with x86-64, as determined in the following problem.

## Practice Problem 4.7 (solution page 484)

Let us determine the behavior of the instruction `pushq %rsp` for an x86-64 processor. We could try reading the Intel documentation on this instruction, but a simpler approach is to conduct an experiment on an actual machine. The C compiler would not normally generate this instruction, so we must use hand-generated assembly code for this task. Here is a test function we have written (Web Aside [ASM:EASM](#) on page 178 describes how to write programs that combine C code with handwritten assembly code):

```
1  .text
2  .globl pushtest
3  pushtest:
4  movq  %rsp, %rax    Copy stack pointer
5  pushq %rsp    Push stack pointer
6  Popd  %rdx    Pop it back
7  subq %rdx, %rax Return 0 or 4
8  ret
```

In our experiments, we find that function `pushtest` always returns 0. What does this imply about the behavior of the instruction `pushq %rsp` under x86-64?

A similar ambiguity occurs for the instruction `popq %rsp`. It could either set `%rsp` to the value read from memory or to the incremented

stack pointer. As with [Problem 4.7](#), let us run an experiment to determine how an x86-64 machine would handle this instruction, and then design our Y86-64 machine to follow the same convention.

## Practice Problem 4.8 (solution page [484](#))

The following assembly-code function lets us determine the behavior of the instruction `popq %rsp` for x86-64:

```
1  .text
2  .globl poptest
3  poptest:
4  movq  %rsp, %rdi      Save stack pointer
5  pushq $0xabcd Push test value
6  popq  %rsp      Pop to stack pointer
7  movq  %rsp, %rax      Set popped value as
   return value
8  movq  %rdi, %rsp      Restore stack pointer
9  ret
```

We find this function always returns `0xabcd`. What does this imply about the behavior of `popq %rsp`? What other Y86-64 instruction would have the exact same behavior?

## Aside Getting the details right:

### Inconsistencies across x86 models

**Practice Problems 4.7** [□](#) and **4.8** [□](#) are designed to help us devise a consistent set of conventions for instructions that push or pop the stack pointer. There seems to be little reason why one would want to perform either of these operations, and so a natural question to ask is, "Why worry about such picky details?"

Several useful lessons can be learned about the importance of consistency from the following excerpt from the Intel documentation of the `PUSH` instruction [\[51\]](#):

For IA-32 processors from the Intel 286 on, the `PUSH ESP` instruction pushes the value of the `ESP` register as it existed before the instruction was executed. (This is also true for Intel 64 architecture, real-address and virtual-8086 modes of IA-32 architecture.) For the Intel(r) 8086 processor, the `PUSH SP` instruction pushes the new value of the `SP` register (that is the value after it has been decremented by 2).

*(PUSH ESP instruction. Intel Corporation. 50.)*

Although the exact details of this note may be difficult to follow, we can see that it states that, depending on what mode an x86 processor operates under, it will do different things when instructed to push the stack pointer register. Some modes push the original value, while others push the decremented value. (Interestingly, there is no corresponding

ambiguity about popping to the stack pointer register.) There are two drawbacks to this inconsistency:

- It decreases code portability. Programs may have different behavior depending on the processor mode. Although the particular instruction is not at all common, even the potential for incompatibility can have serious consequences.
- It complicates the documentation. As we see here, a special note is required to try to clarify the differences. The documentation for x86 is already complex enough without special cases such as this one.

We conclude, therefore, that working out details in advance and striving for complete consistency can save a lot of trouble in the long run.

## 4.2 Logic Design and the Hardware Control Language HCL

In hardware design, electronic circuits are used to compute functions on bits and to store bits in different kinds of memory elements. Most contemporary circuit technology represents different bit values as high or low voltages on signal wires. In current technology, logic value 1 is represented by a high voltage of around 1.0 volt, while logic value 0 is represented by a low voltage of around 0.0 volts. Three major components are required to implement a digital system: *combinational logic* to compute functions on the bits, *memory elements* to store bits, and *clock signals* to regulate the updating of the memory elements.

In this section, we provide a brief description of these different components. We also introduce HCL (for "hardware control language"), the language that we use to describe the control logic of the different processor designs. We only describe HCL informally here. A complete reference for HCL can be found in Web Aside ARCH:HCL on page 472.

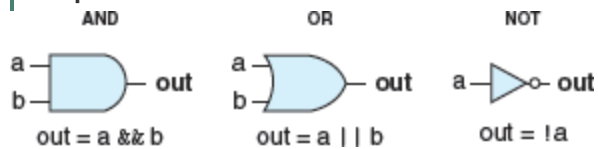


## Aside Modern logic design

At one time, hardware designers created circuit designs by drawing schematic diagrams of logic circuits (first with paper and pencil, and later with computer graphics terminals). Nowadays, most designs are expressed in a *hardware description language* (HDL), a textual notation that looks similar to a programming language but that is used to describe hardware structures rather than program behaviors. The most commonly used languages are Verilog, having a syntax similar to C, and VHDL, having a syntax similar to the Ada programming language. These languages were originally designed for creating simulation models of digital circuits. In the mid-1980s, researchers developed *logic synthesis* programs that could generate efficient circuit designs from HDL descriptions. There are now a number of commercial synthesis programs, and this has become the dominant technique for generating digital circuits. This shift from hand-designed circuits to synthesized ones can be likened to the shift from writing programs in assembly code to writing them in a high-level language and having a compiler generate the machine code.

Our HCL language expresses only the control portions of a hardware design, with only a limited set of operations and with no modularity. As we will see, however, the control logic is the most difficult part of designing a microprocessor. We have developed tools that can directly translate HCL into Verilog, and by combining this code with Verilog code for the

basic hardware units, we can generate HDL descriptions from which actual working microprocessors can be synthesized. By carefully separating out, designing, and testing the control logic, we can create a working microprocessor with reasonable effort. Web Aside ARCH:VLOG on page 467 describes how we can generate Verilog versions of a Y86-64 processor.



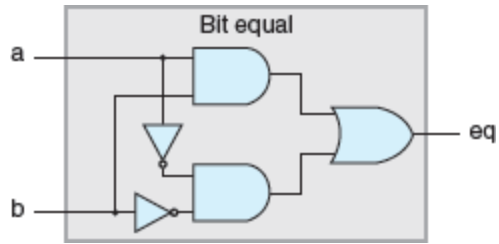
**Figure 4.9 Logic gate types.**

Each gate generates output equal to some Boolean function of its inputs.

## 4.2.1 Logic Gates

Logic gates are the basic computing elements for digital circuits. They generate an output equal to some Boolean function of the bit values at their inputs. [Figure 4.9](#) shows the standard symbols used for Boolean functions AND, OR, and NOT. HCL expressions are shown below the gates for the operators in C ([Section 2.1.8](#)): `&&` for AND, `||` for OR, and `!` for NOT. We use these instead of the bit-level C operators `&`, `|`, and `~`, because logic gates operate on single-bit quantities, not entire words. Although the figure illustrates only two-input versions of the AND and OR gates, it is common to see these being used as  $n$ -way operations for  $n > 2$ . We still write these in HCL using binary operators, though, so the operation of a three-input AND gate with inputs `a`, `b`, and `c` is described with the HCL expression `a && b && c`.

Logic gates are always active. If some input to a gate changes, then within some small amount of time, the output will change accordingly.




**Figure 4.10** Combinational circuit to test for bit equality.  
The output will equal 1 when both inputs are 0 or both are 1.

## 4.2.2 Combinational Circuits and HCL Boolean Expressions

By assembling a number of logic gates into a network, we can construct computational blocks known as *combinational circuits*. Several restrictions are placed on how the networks are constructed:

- Every logic gate input must be connected to exactly one of the following: (1) one of the system inputs (known as a *primary input*), (2) the output connection of some memory element, or (3) the output of some logic gate.
- The outputs of two or more logic gates cannot be connected together. Otherwise, the two could try to drive the wire toward different voltages, possibly causing an invalid voltage or a circuit malfunction.
- The network must be *acyclic*. That is, there cannot be a path through a series of gates that forms a loop in the network. Such loops can cause ambiguity in the function computed by the network.


**Figure 4.10**  shows an example of a simple combinational circuit that we will find useful. It has two inputs, a and b. It generates a single output eq, such that the output will equal 1 if either a and b are both 1 (detected by the upper AND gate) or are both 0 (detected by the lower AND gate). We write the function of this network in HCL as

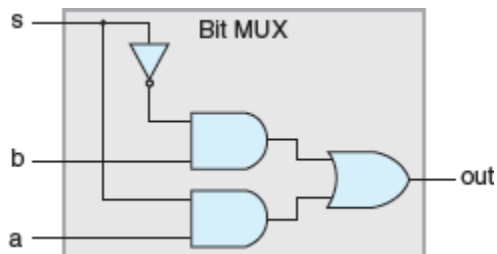
```
bool eq = (a && b) || (!a && !b);
```

This code simply defines the bit-level (denoted by data type `bool`) signal `eq` as a function of inputs `a` and `b`. As this example shows, HCL uses C-style syntax, with `=` associating a signal name with an expression. Unlike C, however, we do not view this as performing a computation and assigning the result to some memory location. Instead, it is simply a way to give a name to an expression.

## Practice Problem 4.9 (solution page 484)

Write an HCL expression for a signal `xor`, equal to the EXCLUSIVE-OR of inputs `a` and `b`. What is the relation between the signals `xor` and `eq` defined above?

**Figure 4.11**  shows another example of a simple but useful combinational circuit known as a *multiplexor* (commonly referred to as a "MUX"). A multiplexor



**Figure 4.11** Single-bit multiplexor circuit.

The output will equal input `a` if the control signal `s` is 1 and will equal input `b` when `s` is 0.

selects a value from among a set of different data signals, depending on the value of a control input signal. In this single-bit multiplexor, the two data signals are the input bits *a* and *b*, while the control signal is the input bit *s*. The output will equal *a* when *s* is 1, and it will equal *b* when *s* is 0. In this circuit, we can see that the two AND gates determine whether to pass their respective data inputs to the OR gate. The upper AND gate passes signal *b* when *s* is 0 (since the other input to the gate is  $\neg s$ ), while the lower AND gate passes signal *a* when *s* is 1. Again, we can write an HCL expression for the output signal, using the same operations as are present in the combinational circuit:

```
bool out = (s && a) || (!s && b);
```

Our HCL expressions demonstrate a clear parallel between combinational logic circuits and logical expressions in C. They both use Boolean operations to compute functions over their inputs. Several differences between these two ways of expressing computation are worth noting:

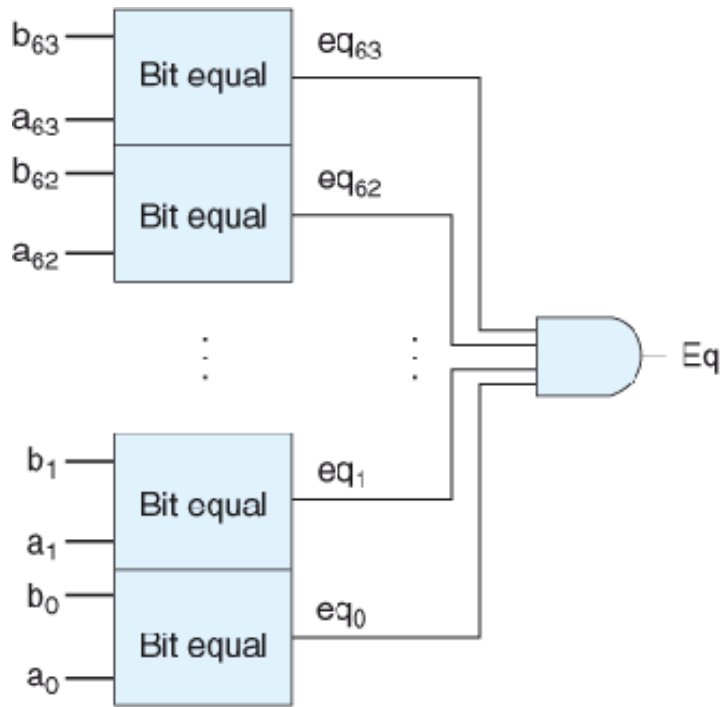
- Since a combinational circuit consists of a series of logic gates, it has the property that the outputs continually respond to changes in the inputs. If some input to the circuit changes, then after some delay, the outputs will change accordingly. By contrast, a C expression is only evaluated when it is encountered during the execution of a program.

- Logical expressions in C allow arguments to be arbitrary integers, interpreting 0 as `FALSE` and anything else as `TRUE`. In contrast, our logic gates only operate over the bit values 0 and 1.
- Logical expressions in C have the property that they might only be partially evaluated. If the outcome of an `AND` or `OR` operation can be determined by just evaluating the first argument, then the second argument will not be evaluated. For example, with the C expression

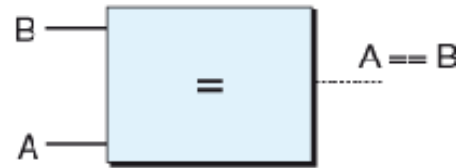
```
(a && !a) && func(b, c)
```

the function `func` will not be called, because the expression `(a && !a)` evaluates to 0. In contrast, combinational logic does not have any partial evaluation rules. The gates simply respond to changing inputs.





(a) Bit-level implementation





(b) Word-level abstraction

**Figure 4.12 Word-level equality test circuit.**

The output will equal 1 when each bit from word A equals its counterpart from word B. Word-level equality is one of the operations in HCL.

## 4.2.3 Word-Level Combinational Circuits and HCL Integer Expressions

By assembling large networks of logic gates, we can construct combinational circuits that compute much more complex functions. Typically, we design circuits that operate on data *words*. These are groups of bit-level signals that represent an integer or some control pattern. For example, our processor designs will contain numerous words, with word sizes ranging between 4 and 64 bits, representing integers, addresses, instruction codes, and register identifiers.

Combinational circuits that perform word-level computations are constructed using logic gates to compute the individual bits of the output word, based on the individual bits of the input words. For example, [Figure 4.12](#)  shows a combinational circuit that tests whether two 64-bit words A and B are equal. That is, the output will equal 1 if and only if each bit of A equals the corresponding bit of B. This circuit is implemented using 64 of the single-bit equality circuits shown in [Figure 4.10](#) . The outputs of these single-bit circuits are combined with an AND gate to form the circuit output.

In HCL, we will declare any word-level signal as an `int`, without specifying the word size. This is done for simplicity. In a full-featured hardware description language, every word can be declared to have

a specific number of bits. HCL allows words to be compared for equality, and so the functionality of the circuit shown in [Figure 4.12](#) can be expressed at the word level as

```
bool Eq = (A == B);
```

where arguments A and B are of type int. Note that we use the same syntax conventions as in C, where '=' denotes assignment and '==' denotes the equality operator.

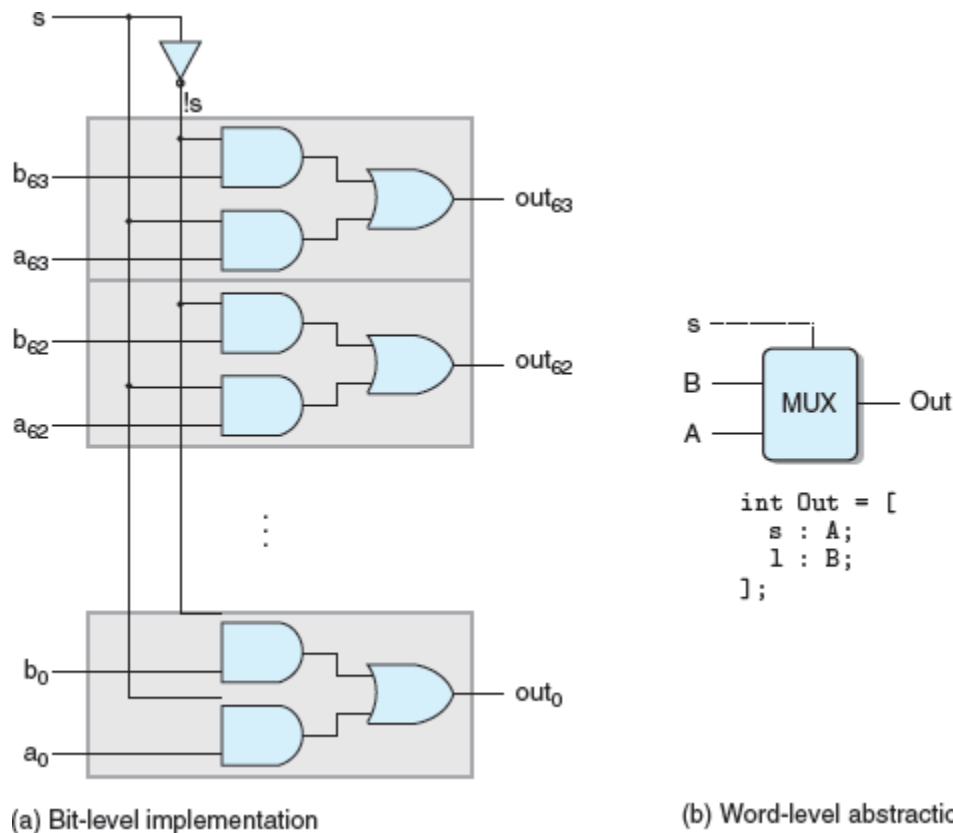
As is shown on the right side of [Figure 4.12](#), we will draw word-level circuits using medium-thickness lines to represent the set of wires carrying the individual bits of the word, and we will show a single-bit signal as a dashed line.

## *Practice Problem 4.10 (solution page 484)*

Suppose you want to implement a word-level equality circuit using the EXCLUSIVE-OR circuits from [Problem 4.9](#) rather than from bit-level equality circuits. Design such a circuit for a 64-bit word consisting of 64 bit-level EXCLUSIVE-OR circuits and two additional logic gates.

[Figure 4.13](#) shows the circuit for a word-level multiplexor. This circuit generates a 64-bit word Out equal to one of the two input words, A or B, depending on the control input bit s. The circuit

consists of 64 identical subcircuits, each having a structure similar to the bit-level multiplexor from [Figure 4.11](#). Rather than replicating the bit-level multiplexor 64 times, the word-level version reduces the number of inverters by generating  $\neg s$  once and reusing it at each bit position.



**Figure 4.13 Word-level multiplexor circuit.**


The output will equal input word A when the control signal  $s$  is 1, and it will equal B otherwise. Multiplexors are described in HCL using case expressions.

We will use many forms of multiplexors in our processor designs. They allow us to select a word from a number of sources depending

on some control condition. Multiplexing functions are described in HCL using *case expressions*. A case expression has the following general form:

```
[
  select1 : expr1;
  select2 : sxpr2;
  :
  selectk : exprk;
]
```

The expression contains a series of cases, where each case  $i$  consists of a Boolean expression  $select_i$ , indicating when this case should be selected, and an integer expression  $expr_i$ , indicating the resulting value.

Unlike the switch statement of C, we do not require the different selection expressions to be mutually exclusive. Logically, the selection expressions are evaluated in sequence, and the case for the first one yielding 1 is selected. For example, the word-level multiplexor of [Figure 4.13](#)  can be described in HCL as

```
word Out = [  
    s: A;  
    1: B;  
];
```

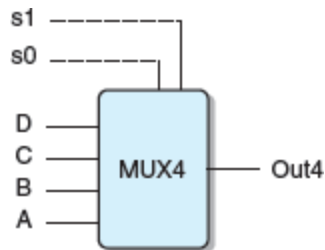
In this code, the second selection expression is simply 1, indicating that this case should be selected if no prior one has been. This is the way to specify a default case in HCL. Nearly all case expressions end in this manner.

Allowing nonexclusive selection expressions makes the HCL code more readable. An actual hardware multiplexor must have mutually exclusive signals controlling which input word should be passed to the output, such as the signals *s* and *!s* in [Figure 4.13](#). To translate an HCL case expression into hardware, a logic synthesis program would need to analyze the set of selection expressions and resolve any possible conflicts by making sure that only the first matching case would be selected.

The selection expressions can be arbitrary Boolean expressions, and there can be an arbitrary number of cases. This allows case expressions to describe blocks where there are many choices of input signals with complex selection criteria. For example, consider the diagram of a 4-way multiplexor shown in [Figure 4.14](#). This circuit selects from among the four input words *A*, *B*, *C*, and *D* based on the control signals *s1* and *s0*, treating the controls as a 2-bit binary number. We can express this in HCL using Boolean

expressions to describe the different combinations of control bit patterns:

```
word Out4 = [  
    !s1 && !s0 : A; # 00
```



**Figure 4.14 Four-way multiplexor.**

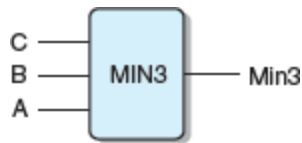
The different combinations of control signals s1 and s0 determine which data input is transmitted to the output.

```
    !s1 : B; # 01  
    !s0 : C; # 10  
    1 : D; # 11  
];
```

The comments on the right (any text starting with # and running for the rest of the line is a comment) show which combination of s1 and s0 will cause the case to be selected. Observe that the selection expressions can sometimes be simplified, since only the first matching case is selected. For example, the second expression can

be written `!s1`, rather than the more complete `!s1 && s0`, since the only other possibility having `s1` equal to 0 was given as the first selection expression. Similarly, the third expression can be written as `!s0`, while the fourth can simply be written as 1.

As a final example, suppose we want to design a logic circuit that finds the minimum value among a set of words A, B, and C, diagrammed as follows:



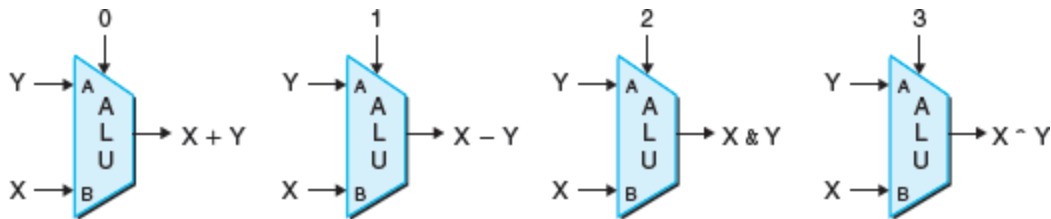
We can express this using an HCL case expression as

```
word Min3 = [  
    A <= B && A <= C : A;  
    B <= A && B <= C : B;  
    1 : C;  
];
```



## Practice Problem 4.11 (solution page 484)

The HCL code given for computing the minimum of three words contains four comparison expressions of the form  $X \leq Y$ . Rewrite the code to compute the same result, but using only three comparisons.



**Figure 4.15 Arithmetic/logic unit (ALU).**

Depending on the setting of the function input, the circuit will perform one of four different arithmetic and logical operations.

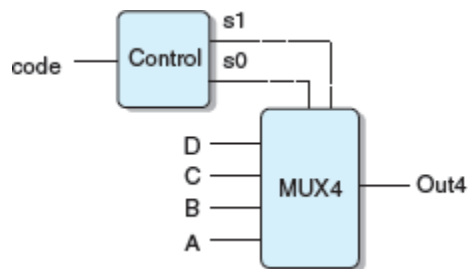
## Practice Problem 4.12 (solution page 484)

Write HCL code describing a circuit that for word inputs A, B, and C selects the *median* of the three values. That is, the output equals the word lying between the minimum and maximum of the three inputs.

Combinational logic circuits can be designed to perform many different types of operations on word-level data. The detailed design of these is beyond the scope of our presentation. One important combinational circuit, known as an *arithmetic/logic unit* (ALU), is diagrammed at an abstract level in [Figure 4.15](#). In our version, the circuit has three inputs: two data inputs labeled A and B and a control input. Depending on the setting of the control input, the circuit will perform different arithmetic or logical operations on the data inputs. Observe that the four operations diagrammed for this ALU correspond to the four different integer operations supported by the Y86-64 instruction set, and the control values match the function codes for these instructions ([Figure 4.3](#)). Note also the ordering of operands for subtraction, where the A input is subtracted from the B input. This ordering is chosen in anticipation of the ordering of arguments in the `subq` instruction.

## 4.2.4 Set Membership

In our processor designs, we will find many examples where we want to compare one signal against a number of possible matching signals, such as to test whether the code for some instruction being processed matches some category of instruction codes. As a simple example, suppose we want to generate the signals `s1` and `s0` for the 4-way multiplexor of [Figure 4.14](#) by selecting the high- and low-order bits from a 2-bit signal code, as follows:



In this circuit, the 2-bit signal code would then control the selection among the four data words `A`, `B`, `C`, and `D`. We can express the generation of signals `s1` and `s0` using equality tests based on the possible values of code:

```
bool s1 = code == 2 || code == 3;
bool s0 = code == 1 || code == 3;
```

A more concise expression can be written that expresses the property that `s1` is 1 when code is in the set `{2, 3}`, and `s0` is 1 when

code is in the set {1, 3}:

```
bool s1 = code in { 2, 3 };  
bool s0 = code in { 1, 3 };
```

The general form of a set membership test is

```
iexpr in {iexpr1, iexpr2, ..., iexprk}
```

where the value being tested (*iexpr*) and the candidate matches (*iexpr*<sub>1</sub> through *iexpr*<sub>*k*</sub>) are all integer expressions.

## 4.2.5 Memory and Clocking

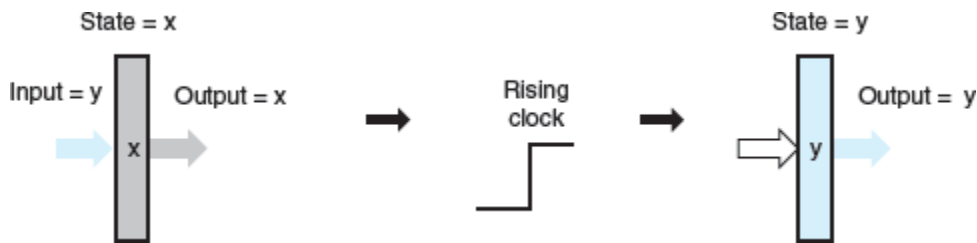
Combinational circuits, by their very nature, do not store any information. Instead, they simply react to the signals at their inputs, generating outputs equal to some function of the inputs. To create *sequential circuits*—that is, systems that have state and perform computations on that state—we must introduce devices that store information represented as bits. Our storage devices are all controlled by a single *clock*, a periodic signal that determines when new values are to be loaded into the devices. We consider two classes of memory devices:

*Clocked registers* (or simply *registers*) store individual bits or words. The clock signal controls the loading of the register with the value at its input.

*Random access memories* (or simply *memories*) store multiple words, using an address to select which word should be read or written. Examples of random access memories include (1) the virtual memory system of a processor, where a combination of hardware and operating system software make it appear to a processor that it can access any word within a large address space; and (2) the register file, where register identifiers serve as the addresses. In a Y86-64 processor, the register file holds the 15 program registers (`%rax` through `%r14`).

As we can see, the word "register" means two slightly different things when speaking of hardware versus machine-language programming. In hardware, a register is directly connected to the rest of the circuit by its input and output wires. In machine-level programming, the registers represent a small collection of addressable words in the


CPU, where the addresses consist of register IDs. These words are generally stored in the register file, although we will see that the hardware can sometimes pass a word directly from one instruction to another to



**Figure 4.16 Register operation.**

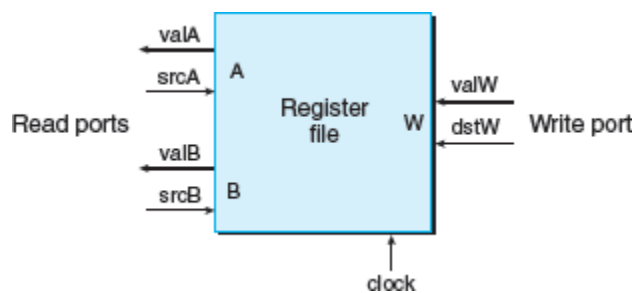
The register outputs remain held at the current register state until the clock signal rises. When the clock rises, the values at the register inputs are captured to become the new register state.

avoid the delay of first writing and then reading the register file. When necessary to avoid ambiguity, we will call the two classes of registers "hardware registers" and "program registers," respectively.

**Figure 4.16**  gives a more detailed view of a hardware register and how it operates. For most of the time, the register remains in a fixed state (shown as x), generating an output equal to its current state. Signals propagate through the combinational logic preceding the register, creating a new value for the register input (shown as y), but the register output remains fixed as long as the clock is low. As the clock rises, the input signals are loaded into the register as its next state (y), and this becomes the new register output until the next rising clock edge. A key point is that the registers serve as barriers

between the combinational logic in different parts of the circuit. Values only propagate from a register input to its output once every clock cycle at the rising clock edge. Our Y86-64 processors will use clocked registers to hold the program counter (PC), the condition codes (CC), and the program status (Stat).

The following diagram shows a typical register file:



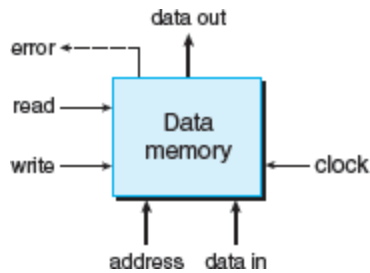
This register file has two *read ports*, named A and B, and one *write port*, named W. Such a *multiported* random access memory allows multiple read and write operations to take place simultaneously. In the register file diagrammed, the circuit can read the values of two program registers and update the state of a third. Each port has an address input, indicating which program register should be selected, and a data output or input giving a value for that program register. The addresses are register identifiers, using the encoding shown in [Figure 4.4](#). The two read ports have address inputs srcA and srcB (short for "source A" and "source B") and data outputs valA and valB (short for "value A" and "value B"). The write port has address input dstW (short for "destination W") and data input valW (short for "value W").

The register file is not a combinational circuit, since it has internal storage. In our implementation, however, data can be read from the register file as if it were a block of combinational logic having addresses as inputs and the data as outputs. When either srcA or srcB is set to some register ID, then, after some delay, the value stored in the corresponding program register will appear on either valA or valB. For example, setting srcA to 3 will cause the value of program register `%rbx` to be read, and this value will appear on output valA.

The writing of words to the register file is controlled by the clock signal in a manner similar to the loading of values into a clocked register. Every time the clock rises, the value on input valW is written to the program register indicated by the register ID on input dstW. When dstW is set to the special ID value `0xF`, no program register is written. Since the register file can be both read and written, a natural question to ask is, "What happens if the circuit attempts to read and write the same register simultaneously?" The answer is straightforward: if the same register ID is used for both a read port and the write port, then, as the clock rises, there will be a transition on the read port's data output from the old value to the new. When we incorporate the register file into our processor design, we will make sure that we take this property into consideration.


Our processor has a random access memory for storing program data, as illustrated below:





This memory has a single address input, a data input for writing, and a data output for reading. Like the register file, reading from our memory operates in a manner similar to combinational logic: If we provide an address on the address input and set the write control signal to 0, then after some delay, the value stored at that address will appear on data out. The error signal will be set to 1 if the address is out of range, and to 0 otherwise. Writing to the memory is controlled by the clock: We set address to the desired address, data in to the desired value, and write to 1. When we then operate the clock, the specified location in the memory will be updated, as long as the address is valid. As with the read operation, the error signal will be set to 1 if the address is invalid. This signal is generated by combinational logic, since the required bounds checking is purely a function of the address input and does not involve saving any state.

## Aside Real-life memory design

The memory system in a full-scale microprocessor is far more complex than the simple one we assume in our design. It consists of several forms of hardware memories, including several random access memories, plus nonvolatile memory or magnetic disk, as well as a variety of hardware and software mechanisms for managing these devices. The design and characteristics of the memory system are described in [Chapter 6](#) .

Nonetheless, our simple memory design can be used for smaller systems, and it provides us with an abstraction of the interface between the processor and memory for more complex systems.

Our processor includes an additional read-only memory for reading instructions. In most actual systems, these memories are merged into a single memory with two ports: one for reading instructions, and the other for reading or writing data.

## 4.3 Sequential Y86-64 Implementations

Now we have the components required to implement a Y86-64 processor. As a first step, we describe a processor called SEQ (for "sequential" processor). On each clock cycle, SEQ performs all the steps required to process a complete instruction. This would require a very long cycle time, however, and so the clock rate would be unacceptably low. Our purpose in developing SEQ is to provide a first step toward our ultimate goal of implementing an efficient pipelined processor.

## 4.3.1 Organizing Processing into Stages

In general, processing an instruction involves a number of operations. We organize them in a particular sequence of stages, attempting to make all instructions follow a uniform sequence, even though the instructions differ greatly in their actions. The detailed processing at each step depends on the particular instruction being executed. Creating this framework will allow us to design a processor that makes best use of the hardware. The following is an informal description of the stages and the operations performed within them:

**Fetch.** The fetch stage reads the bytes of an instruction from memory, using the program counter (PC) as the memory address. From the instruction it extracts the two 4-bit portions of the instruction specifier byte, referred to as icode (the instruction code) and ifun (the instruction function). It possibly fetches a register specifier byte, giving one or both of the register operand specifiers rA and rB. It also possibly fetches an 8-byte constant word valC. It computes valP to be the address of the instruction following the current one in sequential order. That is, valP equals the value of the PC plus the length of the fetched instruction.

**Decode.** The decode stage reads up to two operands from the register file, giving values valA and/or valB. Typically, it reads the

registers designated by instruction fields rA and rB, but for some instructions it reads register `%rsp`.

**Execute.** In the execute stage, the arithmetic/logic unit (ALU) either performs the operation specified by the instruction (according to the value of ifun), computes the effective address of a memory reference, or increments or decrements the stack pointer. We refer to the resulting value as valE. The condition codes are possibly set. For a conditional move instruction, the stage will evaluate the condition codes and move condition (given by ifun) and enable the updating of the destination register only if the condition holds. Similarly, for a jump instruction, it determines whether or not the branch should be taken.

**Memory.** The memory stage may write data to memory, or it may read data from memory. We refer to the value read as valM.

**Write back.** The write-back stage writes up to two results to the register file.




**PC update.** The PC is set to the address of the next instruction.

The processor loops indefinitely, performing these stages. In our simplified implementation, the processor will stop when any exception occurs—that is, when it executes a `halt` or invalid instruction, or it attempts to read or write an invalid address. In a more complete design, the processor would enter an exception-handling mode and begin executing special code determined by the type of exception.

As can be seen by the preceding description, there is a surprising amount of processing required to execute a single instruction. Not only must we perform the stated operation of the instruction, we must also compute addresses, update stack pointers, and determine the next instruction address. Fortunately, the overall flow can be similar for every instruction. Using a very simple and uniform structure is important when designing hardware, since we want to minimize the total amount of hardware and we must ultimately map it onto the two-dimensional surface of an integrated-circuit chip. One way to minimize the complexity is to have the different instructions share as much of the hardware as possible. For example, each of our processor designs contains a single arithmetic/logic unit that is used in different ways depending on the type of instruction being executed. The cost of duplicating blocks of logic in hardware is much higher than the cost of having multiple copies of code in software. It is also more difficult to deal with many special cases and idiosyncrasies in a hardware system than with software.

Our challenge is to arrange the computing required for each of the different instructions to fit within this general framework. We will use the code shown in [Figure 4.17](#) to illustrate the processing of different Y86-64 instructions. [Figures 4.18](#) through [4.21](#) contain tables describing how the different Y86-64 instructions proceed through the stages. It is worth the effort to study these tables carefully. They are in a form that enables a straightforward mapping into the hardware. Each line in these tables describes an assignment to some signal or stored state

```



1      0x000: 30f 209000000000000000 |      irmovq $9, %rdx
2      0x00a: 30f3150000000000000000 |      irmovq $21, %rbx
3      0x014: 6123                      |      subq %rdx, %rbx
# subtract
4      0x016: 30f4800000000000000000 |      irmovq $128,%rsp
# Problem 4.13 
5      0x020: 4043640000000000000000 |      rmmovq %rsp,
100(%rbx)          # store
6      0x02a: a02f                      |      pushq %rdx
# push
7      0x02c: b00f                      |      popq %rax
# Problem 4.14 
8      0x02e: 7340000000000000000000 |      je done
# Not taken
9      0x037: 8041000000000000000000 |      call proc
# Problem 4.18 
10     0x040:                          | done:
11     0x040: 00                        |      halt
12     0x041:                          | proc:
13     0x041: 90                        |      ret
# Return
14

```

**Figure 4.17 Sample Y86-64 instruction sequence.**

We will trace the processing of these instructions through the different stages.

(indicated by the assignment operation ' $\leftarrow$ '). These should be read as if they were evaluated in sequence from top to bottom. When we later map the computations to hardware, we will find that we do not need to perform these evaluations in strict sequential order.

**Figure 4.18**  shows the processing required for instruction types `OPq` (integer and logical operations), `rrmovq` (register-register move), and `irmovq` (immediate-register move). Let us first consider the integer operations. Examining **Figure 4.2** , we can see that we have carefully chosen an encoding of instructions so that the four integer operations (`addq`, `subq`, `andq`, and `xorq`) all have the same value of `icode`. We can handle them all by an identical sequence of steps, except that the ALU computation must be set according to the particular instruction operation, encoded in `ifun`.

The processing of an integer-operation instruction follows the general pattern listed above. In the fetch stage, we do not require a constant word, and so `valP` is computed as  $PC + 2$ . During the decode stage, we read both operands. These are supplied to the ALU in the execute stage, along with the function specifier `ifun`, so that `valE` becomes the instruction result. This computation is shown as the expression `valB OP valA`, where `OP` indicates the operation specified by `ifun`. Note the ordering of the two arguments—this order is consistent with the conventions of Y86-64 (and x86-64). For example, the instruction `subq %rax, %rdx` is supposed to compute the value `R[%rdx] - R[%rax]`. Nothing happens in the memory stage for these instructions, but `valE` is written to register `rB` in the write-back



stage, and the PC is set to valP to complete the instruction execution.


Executing an `rrmovq` instruction proceeds much like an arithmetic operation. We do not need to fetch the second register operand, however. Instead, we set the second ALU input to zero and add this to the first, giving  $valE = valA$ , which is

**Figure 4.18 Computations in sequential implementation of Y86-64 instructions `OPq`, `rrmovq`, and `irmovq`.**

These instructions compute a value and store the result in a register. The notation `icode:ifun` indicates the two components of the instruction byte, while `rA : rB` indicates the two components of the register specifier byte. The notation  $M_1[x]$  indicates accessing (either reading or writing) 1 byte at memory location  $x$ , while  $M_8[x]$  indicates accessing 8 bytes.

then written to the register file. Similar processing occurs for `irmovq`, except that we use constant value `valC` for the first ALU input. In addition, we must increment the program counter by 10 for `irmovq` due to the long instruction format. Neither of these instructions changes the condition codes.

## *Practice Problem 4.13 (solution page 485)*


Fill in the right-hand column of the following table to describe the processing of the `irmovq` instruction on line 4 of the object code in [Figure 4.17](#) :

## Aside Tracing the execution of a `subq` instruction

As an example, let us follow the processing of the `subq` instruction on line 3 of the object code shown in [Figure 4.17](#). We can see that the previous two instructions initialize registers `%rdx` and `%rbx` to 9 and 21, respectively. We can also see that the instruction is located at address `0x014` and consists of 2 bytes, having values `0x61` and `0x23`. The stages would proceed as shown in the following table, which lists the generic rule for processing an `OPq` instruction ([Figure 4.18](#)) on the left, and the computations for this specific instruction on the right.


As this trace shows, we achieve the desired effect of setting register `%rbx` to 12, setting all three condition codes to zero, and incrementing the PC by 2.

How does this instruction execution modify the registers and the PC?

**Figure 4.19**  shows the processing required for the memory write and read instructions `rmmovq` and `mrmovq`. We see the same basic flow as before, but using the ALU to add `valC` to `valB`, giving the effective address (the sum of the displacement and the base register value) for the memory operation. In the memory stage, we either write the register value `valA` to memory or read `valM` from memory.

**Figure 4.19 Computations in sequential implementation of Y86-64 instructions `rmmovq` and `mrmovq`.**

These instructions read or write memory.

**Figure 4.20**  shows the steps required to process `pushq` and `popq` instructions. These are among the most difficult Y86-64 instructions to implement, because they involve both accessing memory and incrementing or decrementing the stack pointer. Although the two instructions have similar flows, they have important differences.

The `pushq` instruction starts much like our previous instructions, but in the decode stage we use `%rsp` as the identifier for the second register operand, giving the stack pointer as value `valB`. In the execute stage, we use the ALU to decrement the stack pointer by 8.

This decremented value is used for the memory write address and is also stored back to `%rsp` in the write-back stage. By using `valE` as the address for the write operation, we adhere to the Y86-64 (and x86-64) convention that `pushq` should decrement the stack pointer before writing, even though the actual updating of the stack pointer does not occur until after the memory operation has completed.

The `popq` instruction proceeds much like `pushq`, except that we read two copies of the stack pointer in the decode stage. This is clearly redundant, but we will see that having the stack pointer as both `valA` and `valB` makes the subsequent flow more similar to that of other instructions, enhancing the overall uniformity of the design. We use the ALU to increment the stack pointer by 8 in the execute stage, but use the unincremented value as the address for the memory operation. In the write-back stage, we update both the stack pointer register with the incremented stack pointer and register `rA` with the value read from memory. Using the unincremented stack pointer as the memory read address preserves the Y86-64

## Aside Tracing the execution of an

### `rmmovq` instruction

Let us trace the processing of the `rmmovq` instruction on line 5 of the object code shown in [Figure 4.17](#). We can see that the previous instruction initialized register `%rsp` to 128, while `%rbx` still holds 12, as computed by the `subq` instruction (line 3). We can also see that the instruction is located at address `0x020` and consists of 10 bytes. The first 2 bytes have values `0x40` and `0x43`, while the final 8 bytes are a byte-reversed version of the number `0x0000000000000064` (decimal 100). The stages would proceed as follows:

As this trace shows, the instruction has the effect of writing 128 to memory address 112 and incrementing the PC by 10. (and x86-64) convention that popq should first read memory and then increment the stack pointer.

## Practice Problem 4.14 (solution page 486)

Fill in the right-hand column of the following table to describe the processing of the `popq` instruction on line 7 of the object code in [Figure 4.17](#).

### Figure 4.20 Computations in sequential implementation of Y86-64 instructions `pushq` and `popq`.

These instructions push and pop the stack.

What effect does this instruction execution have on the registers and the PC?

## Practice Problem 4.15 (solution page 486)

What would be the effect of the instruction `pushq %rsp` according to the steps listed in [Figure 4.20](#)? Does this conform to the desired behavior for Y86-64, as determined in [Problem 4.7](#)?



## Aside Tracing the execution of a `pushq` instruction

Let us trace the processing of the `pushq` instruction on line 6 of the object code shown in [Figure 4.17](#). At this point, we have 9 in register `%rdx` and 128 in register `%rsp`. We can also see that the instruction is located at address `0x02a` and consists of 2 bytes having values `0xa0` and `0x2f`. The stages would proceed as follows:

As this trace shows, the instruction has the effect of setting `%rsp` to 120, writing 9 to address 120, and incrementing the PC by 2.

## *Practice Problem 4.16 (solution page 486)*

Assume the two register writes in the write-back stage for `popq` occur in the order listed in [Figure 4.20](#). What would be the effect of executing `popq %rsp`? Does this conform to the desired behavior for Y86-64, as determined in [Problem 4.8](#)?

[Figure 4.21](#) indicates the processing of our three control transfer instructions: the different jumps, `call`, and `ret`. We see that we can

implement these instructions with the same overall flow as the preceding ones.

As with integer operations, we can process all of the jumps in a uniform manner, since they differ only when determining whether or not to take the branch. A jump instruction proceeds through fetch and decode much like the previous instructions, except that it does not require a register specifier byte. In the execute stage, we check the condition codes and the jump condition to determine whether or not to take the branch, yielding a 1-bit signal `Cnd`. During the PC update stage, we test this flag and set the PC to `valC` (the jump target) if the flag is 1 and to `valP` (the address of the following instruction) if the flag is 0. Our notation  $x ? a : b$  is similar to the conditional expression in C—it yields  $a$  when  $x$  is 1 and  $b$  when  $x$  is 0.

**Figure 4.21 Computations in sequential implementation of Y86-64 instructions `jXX`, `call`, and `ret`.**

These instructions cause control transfers.

## *Practice Problem 4.17 (solution page 486)*

We can see by the instruction encodings ([Figures 4.2](#) and [4.3](#)) that the `rrmovq` instruction is the unconditional version of a more general class of instructions that include the conditional moves. Show how you would modify the steps for the `rrmovq` instruction below to also handle the six conditional move instructions. You may find it useful to see how the implementation of the `jXX` instructions ([Figure 4.21](#)) handles conditional behavior.

## Aside Tracing the execution of a `je` instruction

Let us trace the processing of the `je` instruction on line 8 of the object code shown in [Figure 4.17](#). The condition codes were all set to zero by the `subq` instruction (line 3), and so the branch will not be taken. The instruction is located at address `0x02e` and consists of 9 bytes. The first has value `0x73`, while the remaining 8 bytes are a byte-reversed version of the number `0x0000000000000040`, the jump target. The stages would proceed as follows:

As this trace shows, the instruction has the effect of incrementing the PC by 9.

Instructions `call` and `ret` bear some similarity to instructions `pushq` and `popq`, except that we push and pop program counter values.

With instruction `call`, we push `valP`, the address of the instruction that follows the `call` instruction. During the PC update stage, we set the PC to `valC`, the call destination. With instruction `ret`, we assign `valM`, the value popped from the stack, to the PC in the PC update stage.

## *Practice Problem 4.18 (solution page 487)*

Fill in the right-hand column of the following table to describe the processing of the call instruction on line 9 of the object code in

**Figure 4.17** :

## Aside Tracing the execution of a ret instruction



Let us trace the processing of the ret instruction on line 13 of the object code shown in [Figure 4.17](#). The instruction address is `0x041` and is encoded by a single byte `0x90`. The previous call instruction set `%rsp` to 120 and stored the return address `0x040` at memory address 120. The stages would proceed as follows:

As this trace shows, the instruction has the effect of setting the PC to `0x040`, the address of the `halt` instruction. It also sets `%rsp` to 128.

What effect would this instruction execution have on the registers, the PC, and the memory?

We have created a uniform framework that handles all of the different types of Y86-64 instructions. Even though the instructions have widely varying behavior, we can organize the processing into six stages. Our task now is to create a hardware design that implements the stages and connects them together.

## 4.3.2 SEQ Hardware Structure

The computations required to implement all of the Y86-64 instructions can be organized as a series of six basic stages: fetch, decode, execute, memory, write back, and PC update. [Figure 4.22](#)  shows an abstract view of a hardware structure that can perform these computations. The program counter is stored in a register, shown in the lower left-hand corner (labeled "PC"). Information then flows along wires (shown grouped together as a heavy gray line), first upward and then around to the right. Processing is performed by *hardware units* associated with the different stages. The feedback paths coming back down on the right-hand side contain the updated values to write to the register file and the updated program counter. In SEQ, all of the processing by the hardware units occurs within a single clock cycle, as is discussed in [Section 4.3.3](#) . This diagram omits some small blocks of combinational logic as well as all of the control logic needed to operate the different hardware units and to route the appropriate values to the units. We will add this detail later. Our method of drawing processors with the flow going from bottom to top is unconventional. We will explain the reason for this convention when we start designing pipelined processors.

The hardware units are associated with the different processing stages:



**Fetch.** Using the program counter register as an address, the instruction memory reads the bytes of an instruction. The PC incrementer computes  $valP$ , the incremented program counter.

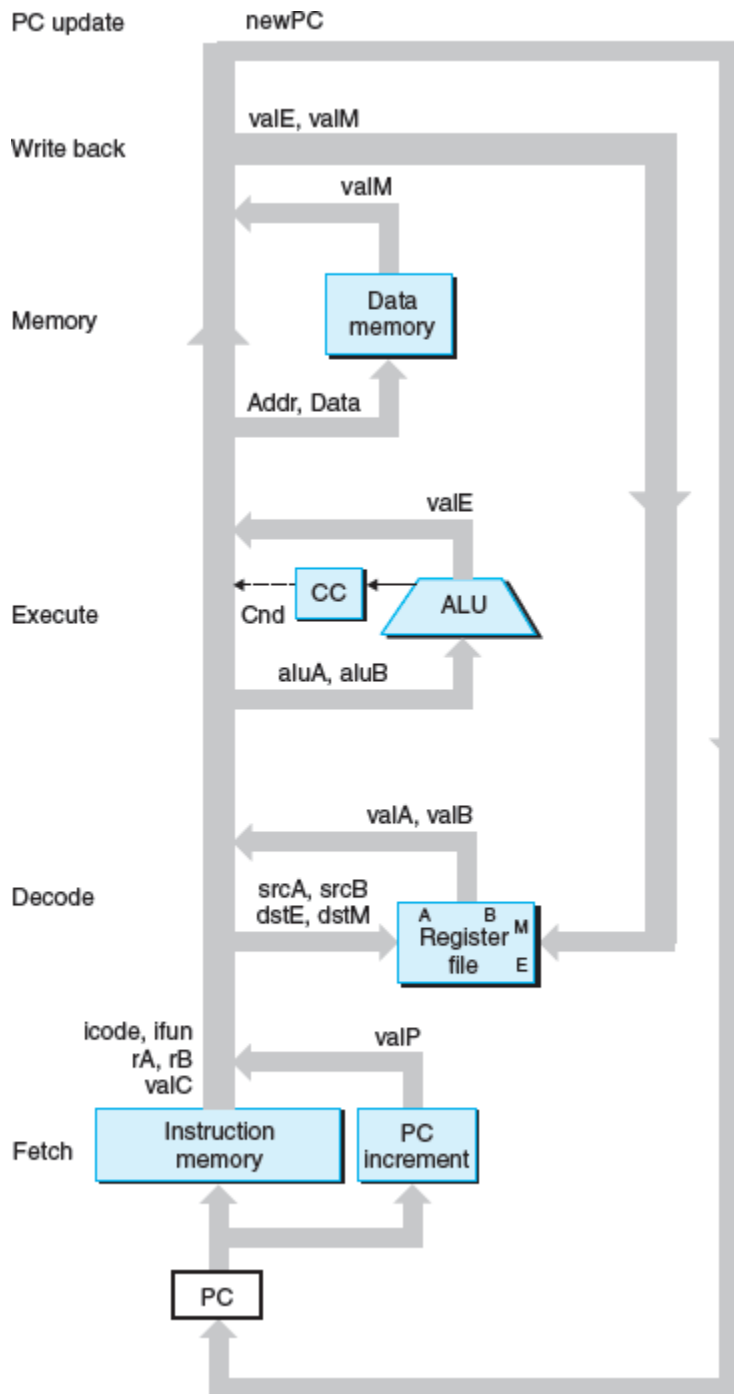
**Decode.** The register file has two read ports, A and B, via which register values  $valA$  and  $valB$  are read simultaneously.

**Execute.** The execute stage uses the arithmetic/logic (ALU) unit for different purposes according to the instruction type. For integer operations, it performs the specified operation. For other instructions, it serves as an adder to compute an incremented or decremented stack pointer, to compute an effective address, or simply to pass one of its inputs to its outputs by adding zero.

The condition code register (CC) holds the three condition code bits. New values for the condition codes are computed by the ALU. When executing a conditional move instruction, the decision as to whether or not to update the destination register is computed based on the condition codes and move condition. Similarly, when executing a jump instruction, the branch signal  $Cnd$  is computed based on the condition codes and the jump type.

**Memory.** The data memory reads or writes a word of memory when executing a memory instruction. The instruction and data memories access the same memory locations, but for different purposes.

**Write back.** The register file has two write ports. Port E is used to write values computed by the ALU, while port M is used to write values read from the data memory.




**Figure 4.22 Abstract view of SEQ, a sequential implementation.**

The information processed during execution of an instruction follows a clockwise flow starting with an instruction fetch using

the program counter (PC), shown in the lower left-hand corner of the figure.

**PC update.** The new value of the program counter is selected to be either  $valP$ , the address of the next instruction,  $valC$ , the destination address specified by a call or jump instruction, or  $valM$ , the return address read from memory.

**Figure 4.23**  gives a more detailed view of the hardware required to implement SEQ (although we will not see the complete details until we examine the individual stages). We see the same set of hardware units as earlier, but now the wires are shown explicitly. In this figure, as well as in our other hardware diagrams, we use the following drawing conventions:

**Clocked registers are shown as white rectangles.** The program counter PC is the only clocked register in SEQ.

**Hardware units are shown as light blue boxes.** These include the memories, the ALU, and so forth. We will use the same basic set of units for all of our processor implementations. We will treat these units as "black boxes" and not go into their detailed designs.

**Control logic blocks are drawn as gray rounded rectangles.** These blocks serve to select from among a set of signal sources or to compute some Boolean function. We will examine these blocks in complete detail, including developing HCL descriptions.

**Wire names are indicated in white circles.** These are simply labels on the wires, not any kind of hardware element.

**Word-wide data connections are shown as medium lines.**

Each of these lines actually represents a bundle of 64 wires, connected in parallel, for transferring a word from one part of the hardware to another.

**Byte and narrower data connections are shown as thin lines.**

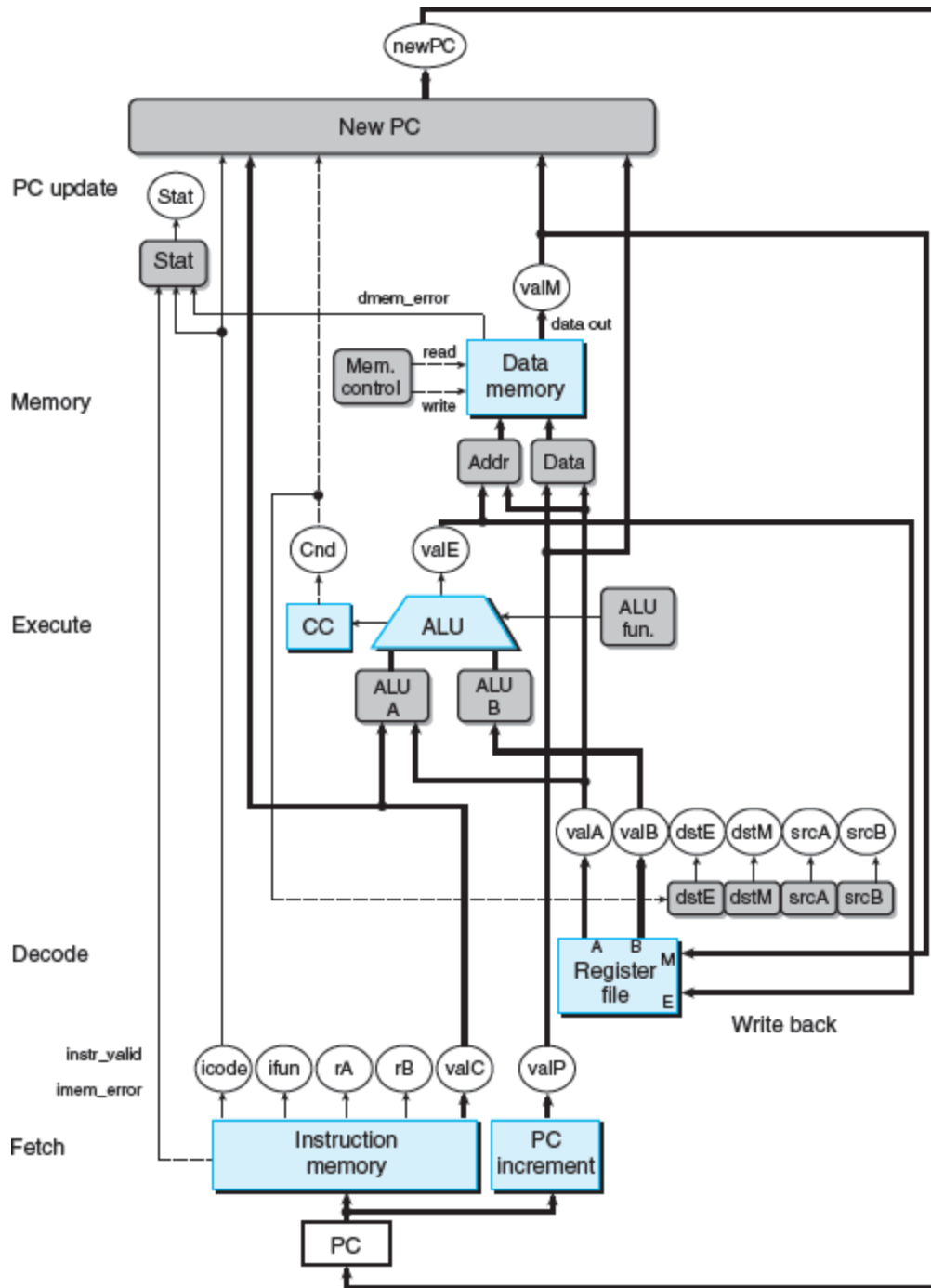
Each of these lines actually represents a bundle of four or eight wires, depending on what type of values must be carried on the wires.

**Single-bit connections are shown as dotted lines.** These represent control values passed between the units and blocks on the chip.

All of the computations we have shown in [Figures 4.18](#) through [4.21](#) have the property that each line represents either the computation of a specific value, such as `valP`, or the activation of some hardware unit, such as the memory. These computations and actions are listed in the second column of [Figure 4.24](#). In addition to the signals we have already described, this list includes four register ID signals: `srcA`, the source of `valA`; `srcB`, the source of `valB`; `dstE`, the register to which `valE` gets written; and `dstM`, the register to which `valM` gets written.

The two right-hand columns of this figure show the computations for the `OPq` and `mrmovq` instructions to illustrate the values being computed. To map the computations into hardware, we want to

implement control logic that will transfer the data between the different hardware units and operate these units in such a way that the specified operations are performed for each of the different instruction types. That is the purpose of the control logic blocks, shown as gray rounded boxes



**Figure 4.23 Hardware structure of SEQ, a sequential implementation.**

Some of the control signals, as well as the register and control word connections, are not shown.

**Figure 4.24 Identifying the different computation steps in the sequential implementation.**

The second column identifies the value being computed or the operation being performed in the stages of SEQ. The computations for instructions `OPq` and `mrmovq` are shown as examples of the computations.

in [Figure 4.23](#). Our task is to proceed through the individual stages and create detailed designs for these blocks.

## 4.3.3 SEQ Timing

In introducing the tables of [Figures 4.18](#) through [4.21](#), we stated that they should be read as if they were written in a programming notation, with the assignments performed in sequence from top to bottom. On the other hand, the hardware structure of [Figure 4.23](#) operates in a fundamentally different way, with a single clock transition triggering a flow through combinational logic to execute an entire instruction. Let us see how the hardware can implement the behavior listed in these tables.

Our implementation of SEQ consists of combinational logic and two forms of memory devices: clocked registers (the program counter and condition code register) and random access memories (the register file, the instruction memory, and the data memory). Combinational logic does not require any sequencing or control—values propagate through a network of logic gates whenever the inputs change. As we have described, we also assume that reading from a random access memory operates much like combinational logic, with the output word generated based on the address input. This is a reasonable assumption for smaller memories (such as the register file), and we can mimic this effect for larger circuits using special clock circuits. Since our instruction memory is only used to read instructions, we can therefore treat this unit as if it were combinational logic.



We are left with just four hardware units that require an explicit control over their sequencing—the program counter, the condition code register, the data memory, and the register file. These are controlled via a single clock signal that triggers the loading of new values into the registers and the writing of values to the random access memories. The program counter is loaded with a new instruction address every clock cycle. The condition code register is loaded only when an integer operation instruction is executed. The data memory is written only when an `rmmovq`, `pushq`, or `call` instruction is executed. The two write ports of the register file allow two program registers to be updated on every cycle, but we can use the special register ID `0xF` as a port address to indicate that no write should be performed for this port.

This clocking of the registers and memories is all that is required to control the sequencing of activities in our processor. Our hardware achieves the same effect as would a sequential execution of the assignments shown in the tables of [Figures 4.18](#) through [4.21](#), even though all of the state updates actually occur simultaneously and only as the clock rises to start the next cycle. This equivalence holds because of the nature of the Y86-64 instruction set, and because we have organized the computations in such a way that our design obeys the following principle:

[OceanofPDF.com](http://OceanofPDF.com)

## Principle:


No reading back

The processor never needs to read back the state updated by an instruction in order to complete the processing of this instruction.

This principle is crucial to the success of our implementation. As an illustration, suppose we implemented the `pushq` instruction by first decrementing `%rsp` by 8 and then using the updated value of `%rsp` as the address of a write operation. This approach would violate the principle stated above. It would require reading the updated stack pointer from the register file in order to perform the memory operation. Instead, our implementation ([Figure 4.20](#)) generates the decremented value of the stack pointer as the signal `valE` and then uses this signal both as the data for the register write and the address for the memory write. As a result, it can perform the register and memory writes simultaneously as the clock rises to begin the next clock cycle.

As another illustration of this principle, we can see that some instructions (the integer operations) set the condition codes, and some instructions (the conditional move and jump instructions) read

these condition codes, but no instruction must both set and then read the condition codes. Even though the condition codes are not set until the clock rises to begin the next clock cycle, they will be updated before any instruction attempts to read them.

**Figure 4.25**  shows how the SEQ hardware would process the instructions at lines 3 and 4 in the following code sequence, shown in assembly code with the instruction addresses listed on the left:

```
1      0x000:  irmovq $0x100, %rbx      # %rbx <-- 0x100
2      0x00a:  irmovq $0x200,%rdx      # %rdx <-- 0x200
3      0x014:  addq %rdx, %rbx # %rbx <-- 0x300 CC <-- 000
4      0x016:  je dest # Not taken
5      0x01f:  rmmovq %rbx,0(%rdx)      # M[0x200] <-- 0x300
6      0x029:  dest: halt
```

Each of the diagrams labeled 1 through 4 shows the four state elements plus the combinational logic and the connections among the state elements. We show the combinational logic as being wrapped around the condition code register, because some of the combinational logic (such as the ALU) generates the input to the condition code register, while other parts (such as the branch computation and the PC selection logic) have the condition code register as input. We show the register file and the data memory as having separate connections for reading and writing, since the read

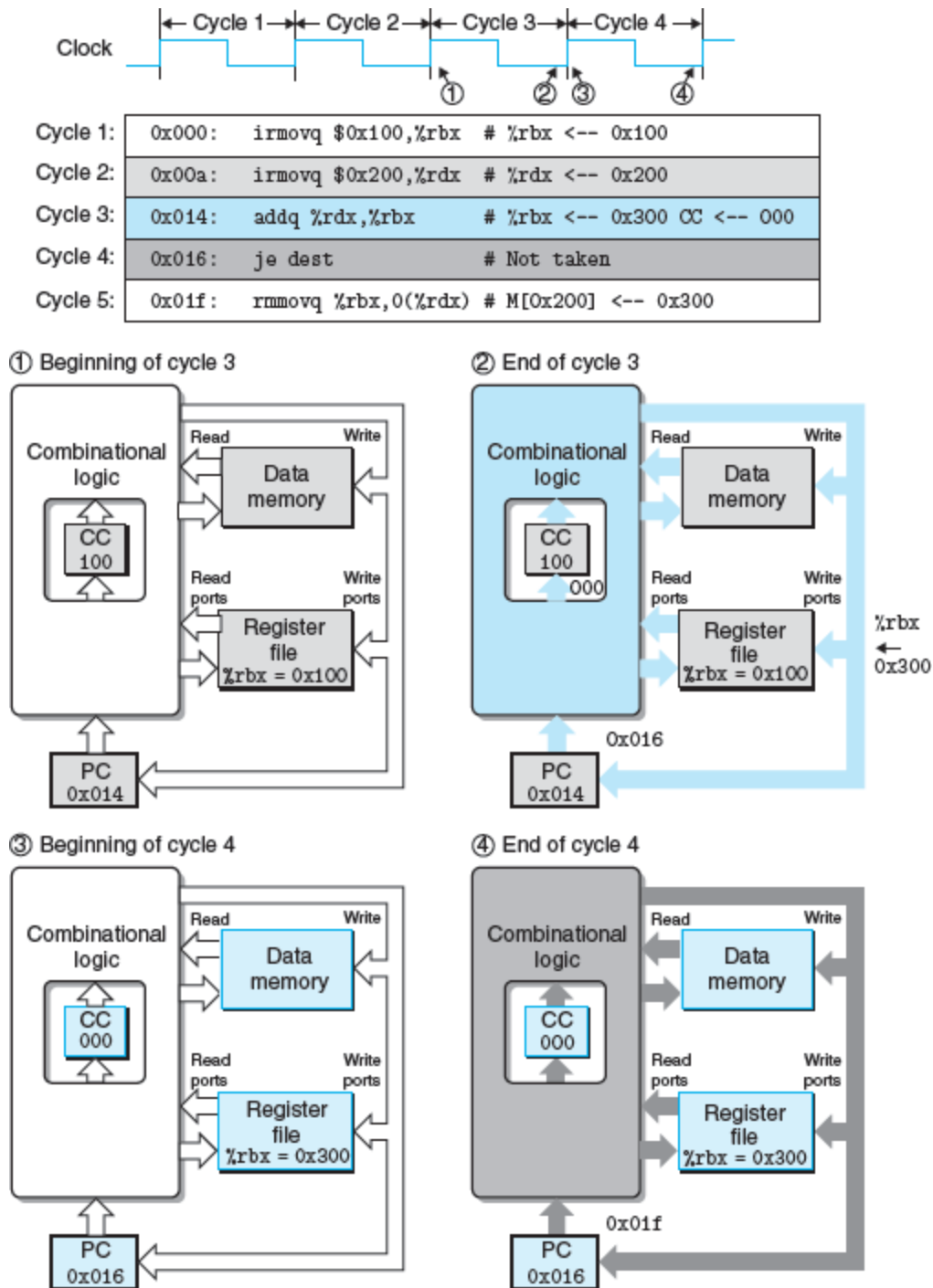
operations propagate through these units as if they were combinational logic, while the write operations are controlled by the clock.

The color coding in [Figure 4.25](#) indicates how the circuit signals relate to the different instructions being executed. We assume the processing starts with the condition codes, listed in the order `ZF`, `SF`, and `OF`, set to `100`. At the beginning of clock cycle 3 (point 1), the state elements hold the state as updated by the second `irmovq` instruction (line 2 of the listing), shown in light gray. The combinational logic is shown in white, indicating that it has not yet had time to react to the changed state. The clock cycle begins with address `0x014` loaded into the program counter. This causes the `addq` instruction (line 3 of the listing), shown in blue, to be fetched and processed. Values flow through the combinational logic, including the reading of the random access memories. By the end of the cycle (point 2), the combinational logic has generated new values (`000`) for the condition codes, an update for program register `%rbx`, and a new value (`0x016`) for the program counter. At this point, the combinational logic has been updated according to the `addq` instruction (shown in blue), but the state still holds the values set by the second `irmovq` instruction (shown in light gray).

As the clock rises to begin cycle 4 (point 3), the updates to the program counter, the register file, and the condition code register occur, and so we show these in blue, but the combinational logic has not yet reacted to these changes, and so we show this in white. In

this cycle, the `je` instruction (line 4 in the listing), shown in dark gray, is fetched and executed. Since condition code `ZF` is 0, the branch is not taken. By the end of the cycle (point 4), a new value of `0x01f` has been generated for the program counter. The combinational logic has been updated according to the `je` instruction (shown in dark gray), but the state still holds the values set by the `addq` instruction (shown in blue) until the next cycle begins.

As this example illustrates, the use of a clock to control the updating of the state elements, combined with the propagation of values through combinational logic, suffices to control the computations performed for each instruction in our implementation of SEQ. Every time the clock transitions from low to high, the processor begins executing a new instruction.



**Figure 4.25 Tracing two cycles of execution by SEQ.**

Each cycle begins with the state elements (program counter, condition code register, register file, and data memory) set according to the previous instruction. Signals propagate through the

combinational logic, creating new values for the state elements. These values are loaded into the state elements to start the next cycle.

## 4.3.4 SEQ Stage Implementations

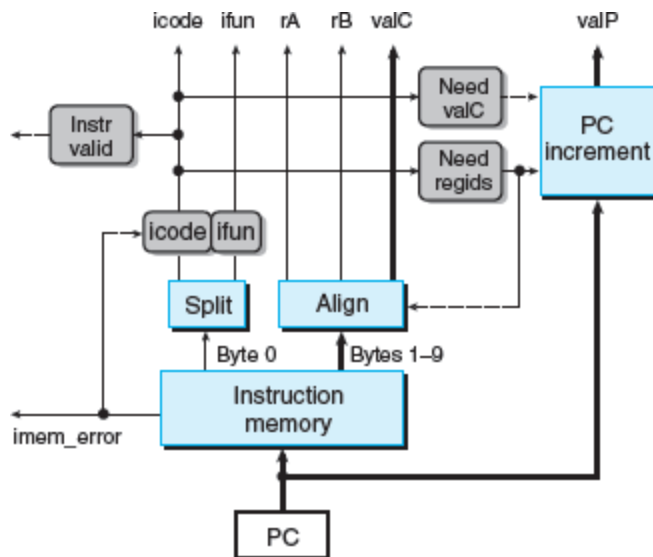
In this section, we devise HCL descriptions for the control logic blocks required to implement SEQ. A complete HCL description for SEQ is given in Web Aside ARCH:HCL on page 472. We show some example blocks here, and others are given as practice problems. We recommend that you work these problems as a way to check your understanding of how the blocks relate to the computational requirements of the different instructions.

Part of the HCL description of SEQ that we do not include here is a definition of the different integer and Boolean signals that can be used as arguments to the HCL operations. These include the names of the different hardware signals, as well as constant values for the different instruction codes, function codes, register names, ALU operations, and status codes. Only those that must be explicitly



### Figure 4.26 Constant values used in HCL descriptions.

These values represent the encodings of the instructions, function codes, register IDs, ALU operations, and status codes.



### Figure 4.27 SEQ fetch stage.

Six bytes are read from the instruction memory using the PC as the starting address. From these bytes, we generate the different instruction fields. The PC increment block computes signal valP.

referenced in the control logic are shown. The constants we use are documented in [Figure 4.26](#). By convention, we use uppercase names for constant values.

In addition to the instructions shown in [Figures 4.18](#) to [4.21](#), we include the processing for the `nop` and `halt` instructions. The `nop` instruction simply flows through stages without much processing,

except to increment the PC by 1. The `halt` instruction causes the processor status to be set to `HLT`, causing it to `halt` operation.

## Fetch Stage

As shown in [Figure 4.27](#), the fetch stage includes the instruction memory hardware unit. This unit reads 10 bytes from memory at a time, using the PC as the address of the first byte (byte 0). This byte is interpreted as the instruction byte and is split (by the unit labeled "Split") into two 4-bit quantities. The control logic blocks labeled "icode" and "ifun" then compute the instruction and function codes as equaling either the values read from memory or, in the event that the instruction address is not valid (as indicated by the signal `imem_error`), the values corresponding to a `nop` instruction. Based on the value of `icode`, we can compute three 1-bit signals (shown as dashed lines):

**`instr_valid`**. Does this byte correspond to a legal Y86-64 instruction? This signal is used to detect an illegal instruction.

**`need_regids`**. Does this instruction include a register specifier byte?

**`need_valC`**. Does this instruction include a constant word?

The signals `instr_valid` and `imem_error` (generated when the instruction address is out of bounds) are used to generate the status code in the memory stage.

As an example, the HCL description for `need_regids` simply determines whether the value of `icode` is one of the instructions that has a register specifier byte:

```
bool need_regids =
    icode in { IRRMOVQ, IOPQ, IPUSHQ, IPOPQ, IIRMOVQ,
    IRMMOVQ, IMRMVQ };
```


## Practice Problem 4.19 (solution page 487)

Write HCL code for the signal `need_valC` in the SEQ implementation.


As [Figure 4.27](#) shows, the remaining 9 bytes read from the instruction memory encode some combination of the register specifier byte and the constant word. These bytes are processed by the hardware unit labeled "Align" into the register fields and the constant word. Byte 1 is split into register specifiers `rA` and `rB` when the computed signal `need_regids` is 1. If `need_regids` is 0, both register specifiers are set to `0xF (RNONE)`, indicating there are no registers specified by this instruction. Recall also ([Figure 4.2](#)) that for any instruction having only one register operand, the other field of the register specifier byte will be `0xF (RNONE)`. Thus, we can assume that the signals `rA` and `rB` either encode registers we want to access or indicate that register access is not required. The unit labeled "Align" also generates the constant word `valC`. This will either be bytes 1-8 or bytes 2-9, depending on the value of signal `need_regids`.

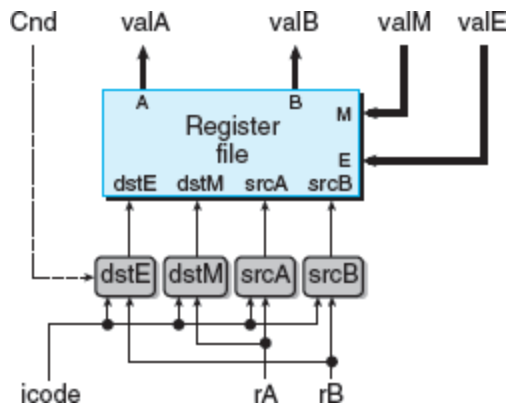
The PC incrementer hardware unit generates the signal  $valP$ , based on the current value of the PC, and the two signals  $need\_regids$  and  $need\_valC$ . For PC value  $p$ ,  $need\_regids$  value  $r$ , and  $need\_valC$  value  $i$ , the incrementer generates the value  $p + 1 + r + 8i$ .

## *Decode and Write-Back Stages*

**Figure 4.28**  provides a detailed view of logic that implements both the decode and write-back stages in SEQ. These two stages are combined because they both access the register file.

The register file has four ports. It supports up to two simultaneous reads (on ports A and B) and two simultaneous writes (on ports E and M). Each port has both an address connection and a data connection, where the address connection is a register ID, and the data connection is a set of 64 wires serving as either an output word (for a read port) or an input word (for a write port) of the register file. The two read ports have address inputs srcA and srcB, while the two write ports have address inputs dstE and dstM. The special identifier `0xF (RNONE)` on an address port indicates that no register should be accessed.

The four blocks at the bottom of **Figure 4.28**  generate the four different register IDs for the register file, based on the instruction code icode, the register specifiers rA and rB, and possibly the condition signal Cnd computed in the execute stage. Register ID srcA indicates which register should be read to generate valA.



**Figure 4.28 SEQ decode and write-back stage.**

The instruction fields are decoded to generate register identifiers for four addresses (two read and two write) used by the register file. The values read from the register file become the signals `valA` and `valB`. The two write-back values `valE` and `valM` serve as the data for the writes.

The desired value depends on the instruction type, as shown in the first row for the decode stage in [Figures 4.18](#) to [4.21](#).

Combining all of these entries into a single computation gives the following HCL description of `srcA` (recall that `RESP` is the register ID of `%rsp`):

```

word srcA = [
    icode in { IRRMOVQ, IRMMOVQ, IOPQ, IPUSHQ } :
rA;
    icode in { IPOPQ, IRET } : RRSP;
    1 : RNONE; # Don't need register
];

```

## Practice Problem 4.20 (solution page [488](#))

The register signal `srcB` indicates which register should be read to generate the signal `valB`. The desired value is shown as the second step in the decode stage in [Figures 4.18](#) to [4.21](#). Write HCL code for `srcB`.

Register ID `dstE` indicates the destination register for write port E, where the computed value `valE` is stored. This is shown in [Figures 4.18](#) to [4.21](#) as the first step in the write-back stage. If we ignore for the moment the conditional move instructions, then we can combine the destination registers for all of the different instructions to give the following HCL description of `dstE`:




```
# WARNING: Conditional move not implemented correctly here word
dstE = [
    icode in { IRRMOVQ } : rB;
    icode in { IIRMOVQ, IOPQ } : rB;
    icode in { IPUSHQ, IPOPQ, ICALL, IRET } : RRSP;
    1 : RNONE; # Don't write any register
];
```

We will revisit this signal and how to implement conditional moves when we examine the execute stage.

## Practice Problem 4.21 (solution page [488](#))

Register ID `dstM` indicates the destination register for write port M, where `valM`, the value read from memory, is stored. This is shown in [Figures 4.18](#) to [4.21](#) as the second step in the write-back stage. Write HCL code for `dstM`.

## Practice Problem 4.22 (solution page [488](#))

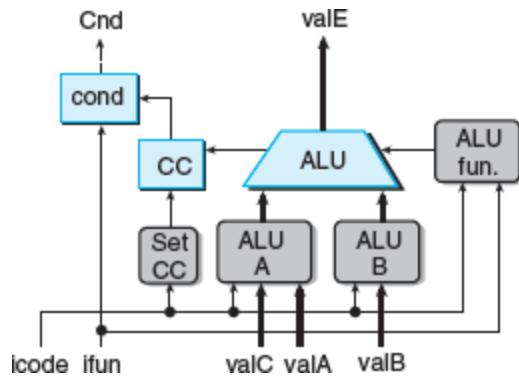
Only the `popq` instruction uses both register file write ports simultaneously. For the instruction `popq %rsp`, the same address will be used for both the E and M write ports, but with different data. To handle this conflict, we must establish a *priority* among the two write ports so that when both attempt to write the same register on the same cycle, only the write from the higher-priority port takes place. Which of the two ports should be given priority in order to implement the desired behavior, as determined in [Practice Problem 4.8](#) ?

## Execute Stage

The execute stage includes the arithmetic/logic unit (ALU). This unit performs the operation `ADD`, `SUBTRACT`, `AND`, or `EXCLUSIVE-OR` on inputs `aluA` and `aluB` based on the setting of the `alufun` signal. These data and control signals are generated by three control blocks, as diagrammed in [Figure 4.29](#). The ALU output becomes the signal `valE`.

In [Figures 4.18](#) to [4.21](#), the ALU computation for each instruction is shown as the first step in the execute stage. The operands are listed with `aluB` first, followed by `aluA` to make sure the `subq` instruction subtracts `valA` from `valB`. We can see that the value of `aluA` can be `valA`, `valC`, or either `-8` or `+8`, depending on the instruction type. We can therefore express the behavior of the control block that generates `aluA` as follows:

```
word aluA = [  
    icode in { IRRMOVQ, IOPQ } : valA;  
    icode in { IIRMOVQ, IRMMOVQ, IMRMOVQ } : valC;
```



**Figure 4.29 SEQ execute stage.**

The ALU either performs the operation for an integer operation instruction or acts as an adder. The condition code registers are set according to the ALU value. The condition code values are tested to determine whether a branch should be taken.

```

icode in { ICALL, IPUSHQ } : -8;
icode in { IRET, IPOPQ } : 8;
# Other instructions don't need ALU
];

```

## Practice Problem 4.23 (solution page [488](#))

Based on the first operand of the first step of the execute stage in [Figures 4.18](#) to [4.21](#), write an HCL description for the signal aluB in SEQ.

Looking at the operations performed by the ALU in the execute stage, we can see that it is mostly used as an adder. For the `IOPQ` instructions, however, we want it to use the operation encoded in the `ifun` field of the instruction. We can therefore write the HCL description for the ALU control as follows:

```
word alufun = [  
    icode == IOPQ : ifun;  
    1 : ALUADD;  
];
```


The execute stage also includes the condition code register. Our ALU generates the three signals on which the condition codes are based—zero, sign, and overflow—every time it operates. However, we only want to set the condition codes when an `IOPQ` instruction is executed. We therefore generate a signal `set_cc` that controls whether or not the condition code register should be updated:

```
bool set_cc = icode in { IOPQ };
```

The hardware unit labeled "cond" uses a combination of the condition codes and the function code to determine whether a conditional branch or data transfer should take place ([Figure 4.3](#)). It generates the `Cnd` signal used both for the setting of `dstE` with conditional moves and in the next PC logic for conditional branches.

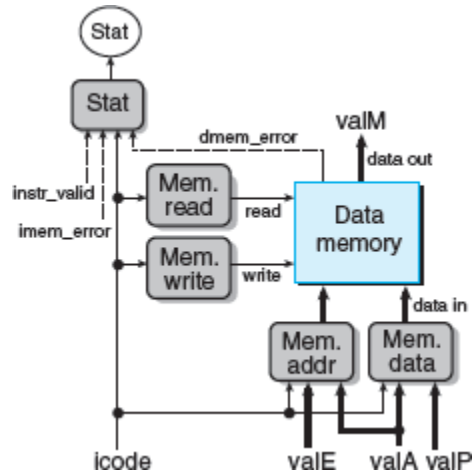
For other instructions, the Cnd signal may be set to either 1 or 0, depending on the instruction's function code and the setting of the condition codes, but it will be ignored by the control logic. We omit the detailed design of this unit.

## Practice Problem 4.24 (solution page [488](#))

The conditional move instructions, abbreviated `cmovXX`, have instruction code `IRRM0VQ`. As [Figure 4.28](#)  shows, we can implement these instructions by making use of the Cnd signal, generated in the execute stage. Modify the HCL code for `dstE` to implement these instructions.

# Memory Stage

The memory stage has the task of either reading or writing program data. As shown in [Figure 4.30](#), two control blocks generate the values for the memory



**Figure 4.30** SEQ memory stage.

The data memory can either write or read memory values. The value read from memory forms the signal valM.

address and the memory input data (for write operations). Two other blocks generate the control signals indicating whether to perform a read or a write operation. When a read operation is performed, the data memory generates the value valM.

The desired memory operation for each instruction type is shown in the memory stage of [Figures 4.18](#) to [4.21](#). Observe that the address for memory reads and writes is always valE or valA. We can describe this block in HCL as follows:

```
word mem_addr = [  
    icode in { IRMMOVQ, IPUSHQ, ICALL, IMRMVQ } : valE;  
    icode in { IPOPQ, IRET } : valA;  
    # Other instructions don't need address  
];
```

## Practice Problem 4.25 (solution page [488](#))

Looking at the memory operations for the different instructions shown in [Figures 4.18](#) to [4.21](#), we can see that the data for memory writes are always either valA or valP. Write HCL code for the signal mem\_data in SEQ.

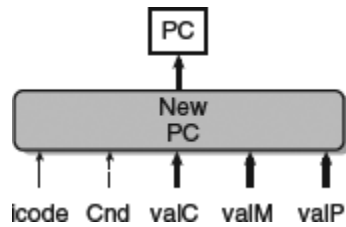
We want to set the control signal mem\_read only for instructions that read data from memory, as expressed by the following HCL code:

```
bool mem_read = icode in { IMRMVQ, IPOPQ, IRET };
```

## Practice Problem 4.26 (solution page [489](#))

We want to set the control signal mem\_write only for instructions that write data to memory. Write HCL code for the signal mem\_write in SEQ.






**Figure 4.31 SEQ PC update stage.**

The next value of the PC is selected from among the signals `valC`, `valM`, and `valP`, depending on the instruction code and the branch flag.

A final function for the memory stage is to compute the status code `Stat` resulting from the instruction execution according to the values of `icode`, `imem_error`, and `instr_valid` generated in the fetch stage and the signal `dmem_error` generated by the data memory.

## Practice Problem 4.27 (solution page [489](#))

Write HCL code for `Stat`, generating the four status codes `SAOK`, `SADR`, `SINS`, and `SHLT` (see [Figure 4.26](#) .

## *PC Update Stage*

The final stage in SEQ generates the new value of the program counter (see [Figure 4.31](#)). As the final steps in [Figures 4.18](#) to [4.21](#) show, the new PC will be valC, valM, or valP, depending on the instruction type and whether or not a branch should be taken.

This selection can be described in HCL as follows:

```
word new_pc = [  
    # Call. Use instruction constant  
    icode == ICALL : valC;  
    # Taken branch. Use instruction constant  
    icode == IJXX && Cnd : valC;  
    # Completion of RET instruction. Use value from stack  
    icode == IRET : valM;  
    # Default: Use incremented PC  
    1 : valP;  
];
```

## *Surveying SEQ*

We have now stepped through a complete design for a Y86-64 processor. We have seen that by organizing the steps required to execute each of the different instructions into a uniform flow, we can implement the entire processor with a small number of different hardware units and with a single clock to control the sequencing of computations. The control logic must then route the signals between these units and generate the proper control signals based on the instruction types and the branch conditions.

The only problem with SEQ is that it is too slow. The clock must run slowly enough so that signals can propagate through all of the stages within a single cycle. As an example, consider the processing of a `ret` instruction. Starting with an updated program counter at the beginning of the clock cycle, the instruction must be read from the instruction memory, the stack pointer must be read from the register file, the ALU must increment the stack pointer by 8, and the return address must be read from the memory in order to determine the next value for the program counter. All of these must be completed by the end of the clock cycle.

This style of implementation does not make very good use of our hardware units, since each unit is only active for a fraction of the total clock cycle. We will see that we can achieve much better performance by introducing pipelining.

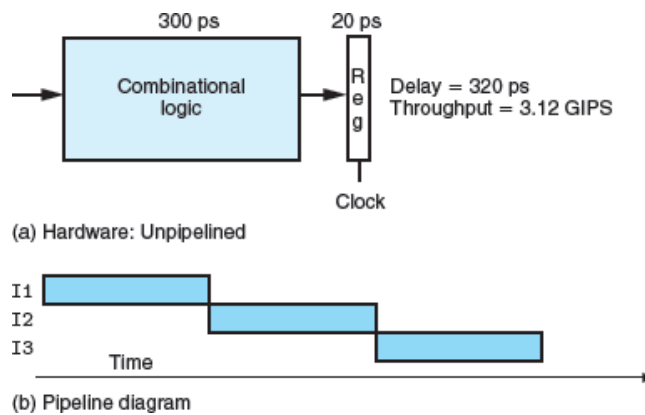
## 4.4 General Principles of Pipelining

Before attempting to design a pipelined Y86-64 processor, let us consider some general properties and principles of pipelined systems. Such systems are familiar to anyone who has been through the serving line at a cafeteria or run a car through an automated car wash. In a pipelined system, the task to be performed is divided into a series of discrete stages. In a cafeteria, this involves supplying salad, a main dish, dessert, and beverage. In a car wash, this involves spraying water and soap, scrubbing, applying wax, and drying. Rather than having one customer run through the entire sequence from beginning to end before the next can begin, we allow multiple customers to proceed through the system at once. In a traditional cafeteria line, the customers maintain the same order in the pipeline and pass through all stages, even if they do not want some of the courses. In the case of the car wash, a new car is allowed to enter the spraying stage as the preceding car moves from the spraying stage to the scrubbing stage. In general, the cars must move through the system at the same rate to avoid having one car crash into the next.

A key feature of pipelining is that it increases the *throughput* of the system (i.e., the number of customers served per unit time), but it may also slightly increase the *latency* (i.e., the time required to service an individual customer). For example, a customer in a cafeteria who only wants a dessert could pass through a nonpipelined system very quickly, stopping only at the dessert stage. A customer in a pipelined system who attempts to go directly to the dessert stage risks incurring the wrath of other customers.

## 4.4.1 Computational Pipelines

Shifting our focus to computational pipelines, the "customers" are instructions and the stages perform some portion of the instruction execution. [Figure 4.32](#) (a) shows an example of a simple nonpipelined hardware system. It consists of some logic that performs a computation, followed by a register to hold the results of this computation. A clock signal controls the loading of the register at some regular time interval. An example of such a system is the decoder in a compact disk (CD) player. The incoming signals are the bits read from the surface of the CD, and



**Figure 4.32 Unpipelined computation hardware.**

On each 320 ps cycle, the system spends 300 ps evaluating a combinational logic function and 20 ps storing the results in an output register.

the logic decodes these to generate audio signals. The computational block in the figure is implemented as combinational logic, meaning that the signals will pass through a series of logic gates, with the outputs becoming some function of the inputs after some time delay.

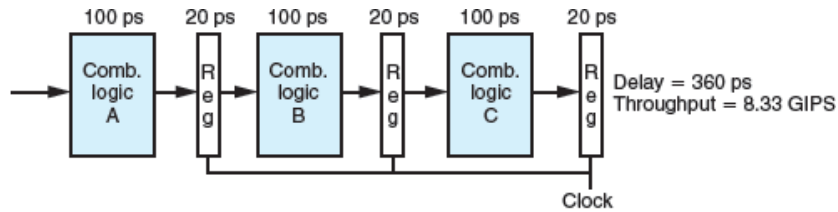
In contemporary logic design, we measure circuit delays in units of *picoseconds* (abbreviated "ps"), or  $10^{-12}$  seconds. In this example, we assume the combinational logic requires 300 ps, while the loading of the register requires 20 ps. [Figure 4.32](#) shows a form of timing diagram known as a *pipeline diagram*. In this

diagram, time flows from left to right. A series of instructions (here named **I1**, **I2**, and **I3**) are written from top to bottom. The solid rectangles indicate the times during which these instructions are executed. In this implementation, we must complete one instruction before beginning the next. Hence, the boxes do not overlap one another vertically. The following formula gives the maximum rate at which we could operate the system:

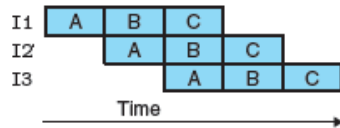
$$Throughput = \frac{1 \text{ instruction}}{(20 + 300) \text{ picoseconds}} \cdot \frac{1,000 \text{ picoseconds}}{1 \text{ nanosecond}} \approx 3.12 \text{ GIPS}$$

We express throughput in units of giga-instructions per second (abbreviated GIPS), or billions of instructions per second. The total time required to perform a single instruction from beginning to end is known as the *latency*. In this system, the latency is 320 ps, the reciprocal of the throughput.

Suppose we could divide the computation performed by our system into three stages, A, B, and C, where each requires 100 ps, as illustrated in [Figure 4.33](#). Then we could put *pipeline registers* between the stages so that each instruction moves through the system in three steps, requiring three complete clock cycles from beginning to end. As the pipeline diagram in [Figure 4.33](#) illustrates, we could allow **I2** to enter stage A as soon as **I1** moves from A to B, and so on. In steady state, all three stages would be active, with one instruction leaving and a new one entering the system every clock cycle. We can see this during the third clock cycle in the pipeline diagram where **I1** is in stage C, **I2** is in stage B, and **I3** is in stage A. In



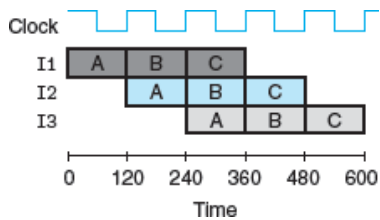
(a) Hardware: Three-stage pipeline



(b) Pipeline diagram

**Figure 4.33 Three-stage pipelined computation hardware.**

The computation is split into stages A, B, and C. On each 120 ps cycle, each instruction progresses through one stage.



**Figure 4.34 Three-stage pipeline timing.**

The rising edge of the clock signal controls the movement of instructions from one pipeline stage to the next.

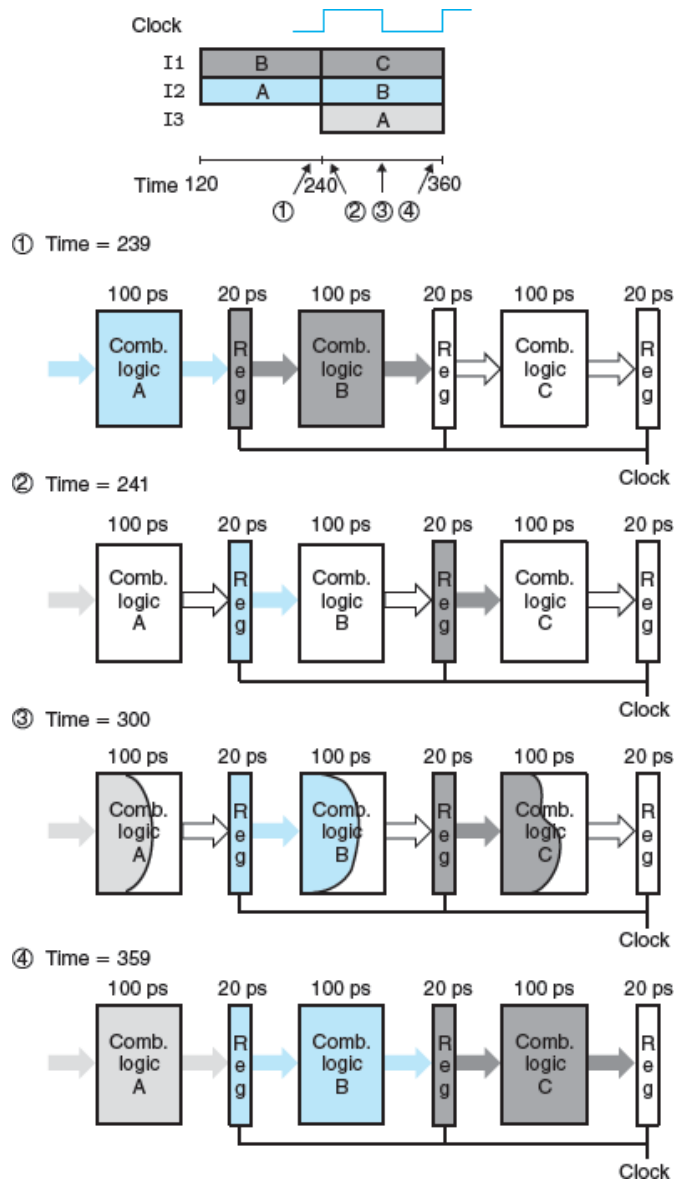
this system, we could cycle the clocks every  $100 + 20 = 120$  picoseconds, giving a throughput of around 8.33 GIPS. Since processing a single instruction requires 3 clock cycles, the latency of this pipeline is  $3 \times 120 = 360$  ps. We have increased the throughput of the system by a factor of  $8.33/3.12 = 2.67$  at the expense of some added hardware and a slight increase in the latency ( $360/320 = 1.12$ ). The increased latency is due to the time overhead of the added pipeline registers.

## 4.4.2 A Detailed Look at Pipeline Operation

To better understand how pipelining works, let us look in some detail at the timing and operation of pipeline computations. [Figure 4.34](#) shows the pipeline diagram for the three-stage pipeline we have already looked at ([Figure 4.33](#)). The transfer of the instructions between pipeline stages is controlled by a clock signal, as shown above the pipeline diagram. Every 120 ps, this signal rises from 0 to 1, initiating the next set of pipeline stage evaluations.

[Figure 4.35](#) traces the circuit activity between times 240 and 360, as instruction [I1](#) (shown in dark gray) propagates through stage C, [I2](#) (shown in blue)





**Figure 4.35 One clock cycle of pipeline operation.**


Just before the clock rises at time 240 (point 1), instructions **I1** (shown in dark gray) and **I2** (shown in blue) have completed stages B and A. After the clock rises, these instructions begin propagating through stages C and B, while instruction **I3** (shown in light gray) begins propagating through stage A (points 2 and 3). Just before the clock rises again, the results for the instructions have propagated to the inputs of the pipeline registers (point 4).

propagates through stage B, and I3 (shown in light gray) propagates through stage A. Just before the rising clock at time 240 (point 1), the values computed in stage A for instruction I2 have reached the input of the first pipeline register, but its state and output remain set to those computed during stage A for instruction I1. The values computed in stage B for instruction I1 have reached the input of the second pipeline register. As the clock rises, these inputs are loaded into the pipeline registers, becoming the register outputs (point 2). In addition, the input to stage A is set to initiate the computation of instruction I3. The signals then propagate through the combinational logic for the different stages (point 3). As the curved wave fronts in the diagram at point 3 suggest, signals can propagate through different sections at different rates. Before time 360, the result values reach the inputs of the pipeline registers (point 4). When the clock rises at time 360, each of the instructions will have progressed through one pipeline stage.

We can see from this detailed view of pipeline operation that slowing down the clock would not change the pipeline behavior. The signals propagate to the pipeline register inputs, but no change in the register states will occur until the clock rises. On the other hand, we could have disastrous effects if the clock were run too fast. The values would not have time to propagate through the combinational logic, and so the register inputs would not yet be valid when the clock rises.

As with our discussion of the timing for the SEQ processor ([Section 4.3.3](#)), we see that the simple mechanism of having clocked registers between blocks of combinational logic suffices to control the flow of instructions in the pipeline. As the clock rises and falls repeatedly, the different instructions flow through the stages of the pipeline without interfering with one another.

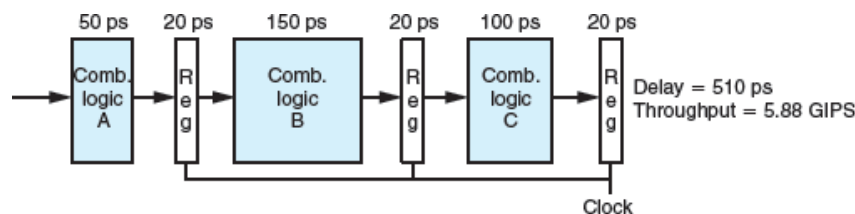
## 4.4.3 Limitations of Pipelining

The example of [Figure 4.33](#)  shows an ideal pipelined system in which we are able to divide the computation into three independent stages, each requiring one-third of the time required by the original logic. Unfortunately, other factors often arise that diminish the effectiveness of pipelining.

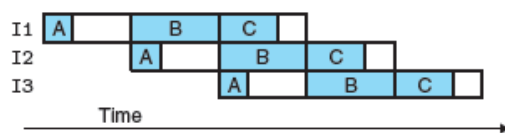
## Nonuniform Partitioning

Figure 4.36 shows a system in which we divide the computation into three stages as before, but the delays through the stages range from 50 to 150 ps. The sum of the delays through all of the stages remains 300 ps. However, the rate at which we can operate the clock is limited by the delay of the slowest stage. As the pipeline diagram in this figure shows, stage A will be idle (shown as a white box) for 100 ps every clock cycle, while stage C will be idle for 50 ps every clock cycle. Only stage B will be continuously active. We must set the clock cycle to  $150 + 20 = 170$  picoseconds, giving a throughput of 5.88 GIPS. In addition, the latency would increase to 510 ps due to the slower clock rate.

Devising a partitioning of the system computation into a series of stages having uniform delays can be a major challenge for hardware designers. Often,



(a) Hardware: Three-stage pipeline, nonuniform stage delays



(b) Pipeline diagram

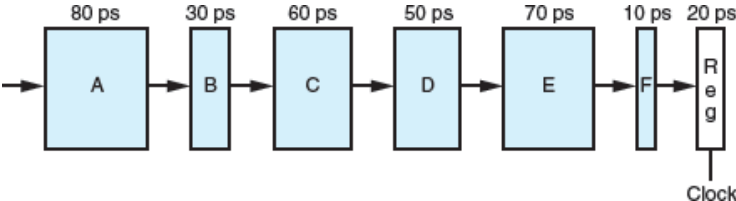
### Figure 4.36 Limitations of pipelining due to nonuniform stage delays.

The system throughput is limited by the speed of the slowest stage.

some of the hardware units in a processor, such as the ALU and the memories, cannot be subdivided into multiple units with shorter delay. This makes it difficult to create a set of balanced stages. We will not concern ourselves with this level of detail in designing our pipelined Y86-64 processor, but it is important to appreciate the importance of timing optimization in actual system design.

# Practice Problem 4.28 (solution page 489)


Suppose we analyze the combinational logic of [Figure 4.32](#) and determine that it can be separated into a sequence of six blocks, named A to F, having delays of 80, 30, 60, 50, 70, and 10 ps, respectively, illustrated as follows:



We can create pipelined versions of this design by inserting pipeline registers between pairs of these blocks. Different combinations of pipeline depth (how many stages) and maximum throughput arise, depending on where we insert the pipeline registers. Assume that a pipeline register has a delay of 20 ps.

- A. Inserting a single register gives a two-stage pipeline. Where should the register be inserted to maximize throughput? What would be the throughput and latency?
- B. Where should two registers be inserted to maximize the throughput of a three-stage pipeline? What would be the throughput and latency?
- C. Where should three registers be inserted to maximize the throughput of a 4-stage pipeline? What would be the throughput and latency?
- D. What is the minimum number of stages that would yield a design with the maximum achievable throughput? Describe this design, its throughput, and its latency.

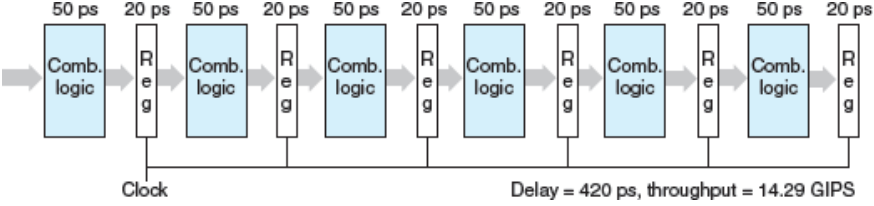
## *Diminishing Returns of Deep Pipelining*

**Figure 4.37**  illustrates another limitation of pipelining. In this example, we have divided the computation into six stages, each requiring 50 ps. Inserting a pipeline register between each pair of stages yields a six-stage pipeline. The minimum clock period for this system is  $50 + 20 = 70$  picoseconds, giving a throughput of 14.29 GIPS. Thus, in doubling the number of pipeline stages, we improve the performance by a factor of  $14.29/8.33 = 1.71$ . Even though we have cut the time required for each computation block by a factor of 2, we do not get a doubling of the throughput, due to the delay through the pipeline registers. This delay becomes a limiting factor in the throughput of the pipeline. In our new design, this delay consumes 28.6% of the total clock period.

Modern processors employ very deep pipelines (15 or more stages) in an attempt to maximize the processor clock rate. The processor architects divide the instruction execution into a large number of very simple steps so that each stage can have a very small delay. The circuit designers carefully design the pipeline registers to minimize their delay. The chip designers must also carefully design the clock distribution network to ensure that the clock changes at the exact same time across the entire chip. All of these factors contribute to the challenge of designing high-speed microprocessors.

# Practice Problem 4.29 (solution page 490)

Suppose we could take the system of [Figure 4.32](#) and divide it into an arbitrary number of pipeline stages  $k$ , each having a delay of  $300/k$ , and with each pipeline register having a delay of 20 ps.



**Figure 4.37** Limitations of pipelining due to overhead.

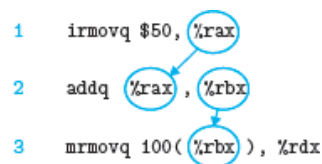
As the combinational logic is split into shorter blocks, the delay due to register updating becomes a limiting factor.

- A. What would be the latency and the throughput of the system, as functions of  $k$ ?
- B. What would be the ultimate limit on the throughput?

## 4.4.4 Pipelining a System with Feedback

Up to this point, we have considered only systems in which the objects passing through the pipeline—whether cars, people, or instructions—are completely independent of one another. For a system that executes machine programs such as x86-64 or Y86-64, however, there are potential dependencies between successive instructions. For example, consider the following Y86-64 instruction sequence:

```
1  irmovq $50, %rax
2  addq  %rax, %rbx
3  mrmovq 100(%rbx), %rdx
```



In this three-instruction sequence, there is a *data dependency* between each successive pair of instructions, as indicated by the circled register names and the arrows between them. The `irmovq` instruction (line 1) stores its result in `%rax`, which then must be read by the `addq` instruction (line 2); and this instruction stores its result in `%rbx`, which must then be read by the `mrmovq` instruction (line 3).

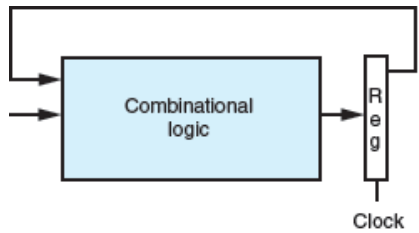
Another source of sequential dependencies occurs due to the instruction control flow. Consider the following Y86-64 instruction sequence:



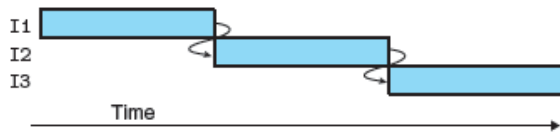
```
1  loop:
2  subq %rdx,%rbx
3  jne targ
4  irmovq $10,%rdx
5  jmp loop
6  targ:
7  halt
```

The `jne` instruction (line 3) creates a *control dependency* since the outcome of the conditional test determines whether the next instruction to execute will be the `irmovq` instruction (line 4) or the `halt` instruction (line 7). In our design for SEQ, these dependencies were handled by the feedback paths shown on the right-hand side of [Figure 4.22](#). This feedback brings the updated register values down to the register file and the new PC value down to the PC register.

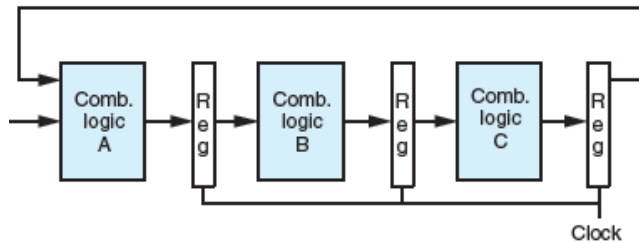
[Figure 4.38](#) illustrates the perils of introducing pipelining into a system containing feedback paths. In the original system ([Figure 4.38\(a\)](#)), the result of each



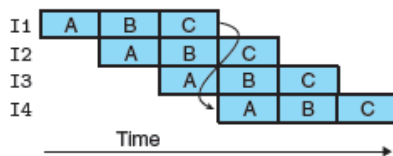
(a) Hardware: Unpipelined with feedback



(b) Pipeline diagram



(c) Hardware: Three-stage pipeline with feedback



(d) Pipeline diagram

**Figure 4.38 Limitations of pipelining due to logical dependencies.**

In going from an unpipelined system with feedback (a) to a pipelined one (c), we change its computational behavior, as can be seen by the two pipeline diagrams (b and d).

instruction is fed back around to the next instruction. This is illustrated by the pipeline diagram (Figure 4.38 (b)), where the result of I1 becomes an input to I2, and so on. If we attempt to convert this to a three-stage pipeline in the most straightforward manner (Figure 4.38 (c)), we change the behavior of the system. As Figure 4.38 (c) shows, the result of I1 becomes an input to I4. In attempting to speed up the system via pipelining, we have changed the system behavior.

When we introduce pipelining into a Y86-64 processor, we must deal with feedback effects properly. Clearly, it would be unacceptable to alter the system behavior as occurred in the example of [Figure 4.38](#). Somehow we must deal with the data and control dependencies between instructions so that the resulting behavior matches the model defined by the ISA.




[OceanofPDF.com](http://OceanofPDF.com)

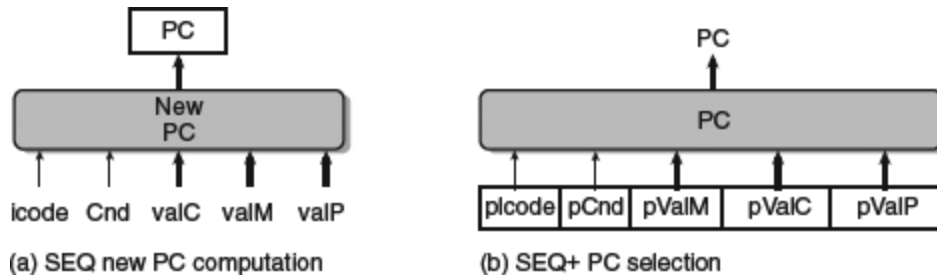
## 4.5 Pipelined Y86-64 Implementations

We are finally ready for the major task of this chapter—designing a pipelined Y86-64 processor. We start by making a small adaptation of the sequential processor SEQ to shift the computation of the PC into the fetch stage. We then add pipeline registers between the stages. Our first attempt at this does not handle the different data and control dependencies properly. By making some modifications, however, we achieve our goal of an efficient pipelined processor that implements the Y86-64 ISA.

## 4.5.1 SEQ+: Rearranging the Computation Stages

As a transitional step toward a pipelined design, we must slightly rearrange the order of the five stages in SEQ so that the PC update stage comes at the beginning of the clock cycle, rather than at the end. This transformation requires only minimal change to the overall hardware structure, and it will work better with the sequencing of activities within the pipeline stages. We refer to this modified design as SEQ+.

We can move the PC update stage so that its logic is active at the beginning of the clock cycle by making it compute the PC value for the *current* instruction. **Figure 4.39**  shows how SEQ and SEQ+ differ in their PC computation. With SEQ (**Figure 4.39**  (a)), the PC computation takes place at the end of the clock cycle, computing the new value for the PC register based on the values of signals computed during the current clock cycle. With SEQ+ (**Figure 4.39**  (b)), we create state registers to hold the signals computed during an instruction. Then, as a new clock cycle begins, the values propagate through the exact same logic to compute the PC for the now-current instruction. We label the registers “plcode,”





**Figure 4.39** Shifting the timing of the PC computation.

With SEQ+, we compute the value of the program counter for the current state as the first step in instruction execution.

## Aside Where is the PC in SEQ+?

One curious feature of SEQ+ is that there is no hardware register storing the program counter. Instead, the PC is computed dynamically based on some state information stored from the previous instruction. This is a small illustration of the fact that we can implement a processor in a way that differs from the conceptual model implied by the ISA, as long as the processor correctly executes arbitrary machine-language programs. We need not encode the state in the form indicated by the programmer-visible state, as long as the processor can generate correct values for any part of the programmer-visible state (such as the program counter). We will exploit this principle even more in creating a pipelined design. Out-of-order processing techniques, as described in [Section 5.7](#), take this idea to an extreme by executing instructions in a completely different order than they occur in the machine-level program.

“pCnd,” and so on, to indicate that on any given cycle, they hold the control signals generated during the previous cycle.

**Figure 4.40**  shows a more detailed view of the SEQ+ hardware. We can see that it contains the exact same hardware units and control blocks that we had in SEQ (**Figure 4.23** ) , but with the PC logic shifted from the top, where it was active at the end of the clock cycle, to the bottom, where it is active at the beginning.

The shift of state elements from SEQ to SEQ+ is an example of a general transformation known as *circuit retiming* [68]. Retiming changes the state representation for a system without changing its logical behavior. It is often used to balance the delays between the different stages of a pipelined system.

## 4.5.2 Inserting Pipeline Registers

In our first attempt at creating a pipelined Y86-64 processor, we insert pipeline registers between the stages of SEQ+ and rearrange signals somewhat, yielding the PIPE— processor, where the "-" in the name signifies that this processor has somewhat less performance than our ultimate processor design. The structure of PIPE— is illustrated in [Figure 4.41](#). The pipeline registers are shown in this figure as blue boxes, each containing different fields that are shown as white boxes. As indicated by the multiple fields, each pipeline register holds multiple bytes and words. Unlike the labels shown in rounded boxes in the hardware structure of the two sequential processors ([Figures 4.23](#) and [4.40](#)), these white boxes represent actual hardware components.

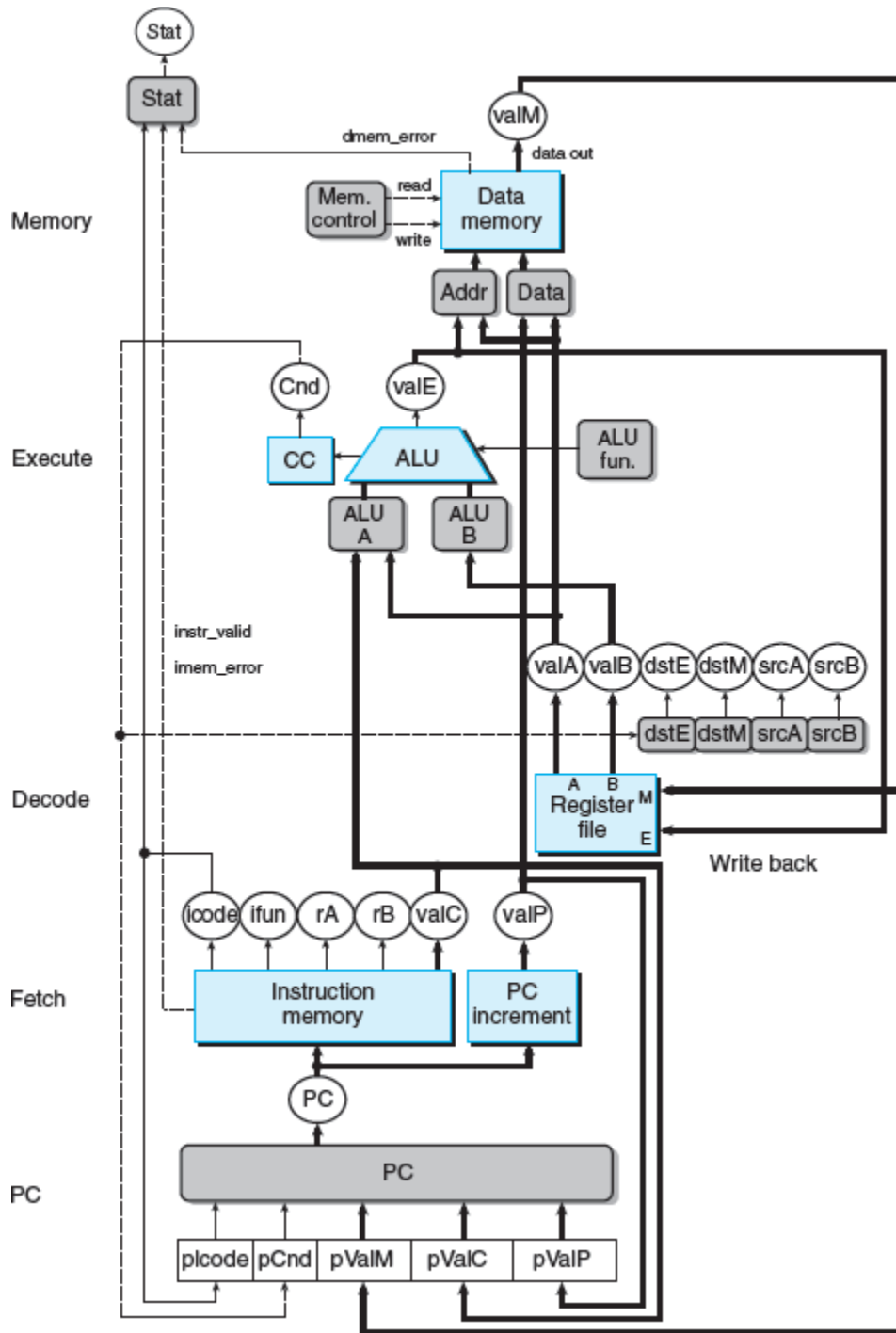
Observe that PIPE— uses nearly the same set of hardware units as our sequential design SEQ ([Figure 4.40](#)), but with the pipeline registers separating the stages. The differences between the signals in the two systems is discussed in [Section 4.5.3](#).

The pipeline registers are labeled as follows:

**F** holds a *predicted* value of the program counter, as will be discussed shortly.

**D** sits between the fetch and decode stages. It holds information about the most recently fetched instruction for processing by the decode stage.





**Figure 4.40 SEQ+ hardware structure.**

Shifting the PC computation from the end of the clock cycle to the beginning makes it more suitable for pipelining.

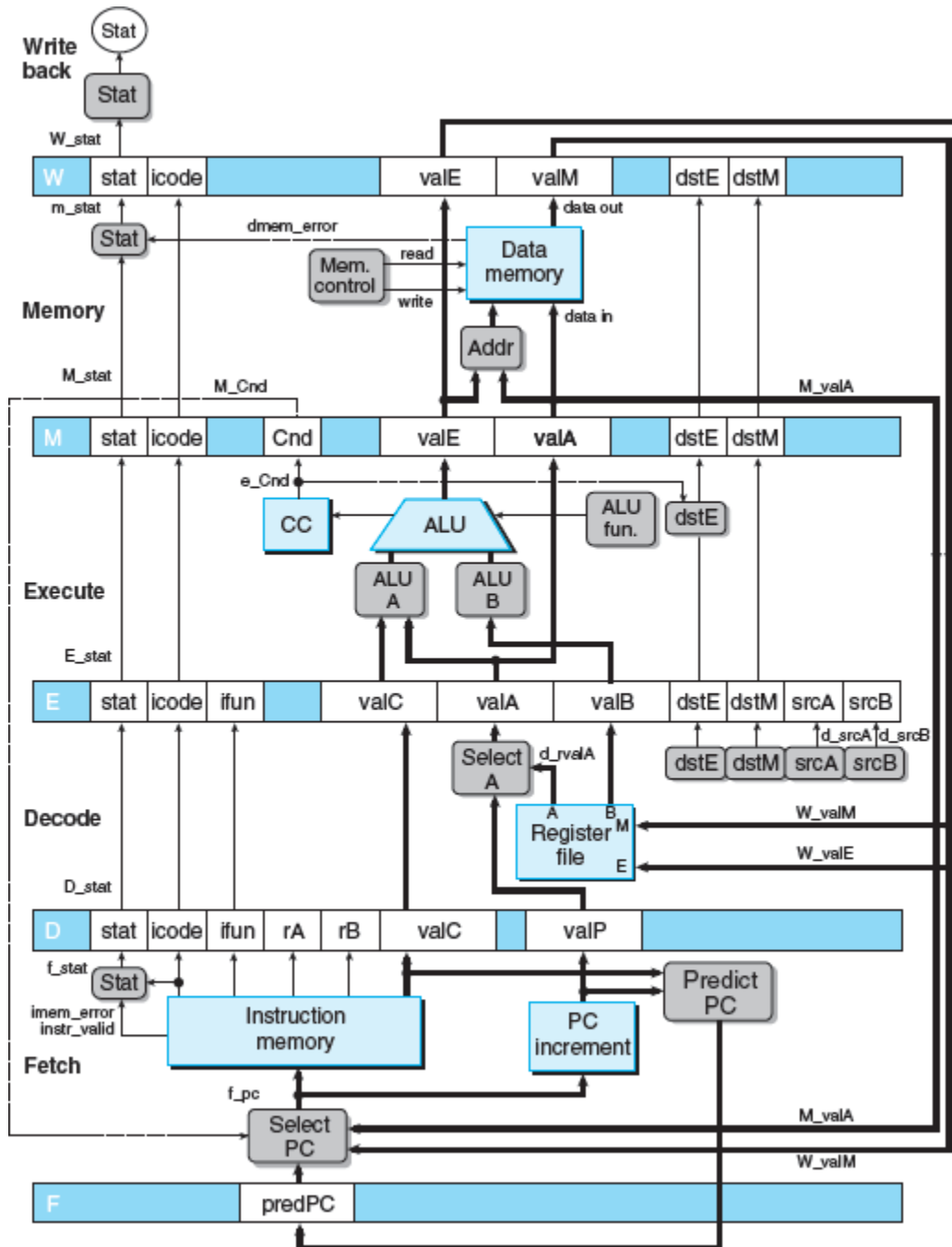



Figure 4.41 Hardware structure of PIPE—, an initial pipelined implementation.

By inserting pipeline registers into SEQ+ (Figure 4.40), we create a five-stage pipeline. There are several shortcomings of this version that we will deal with shortly.

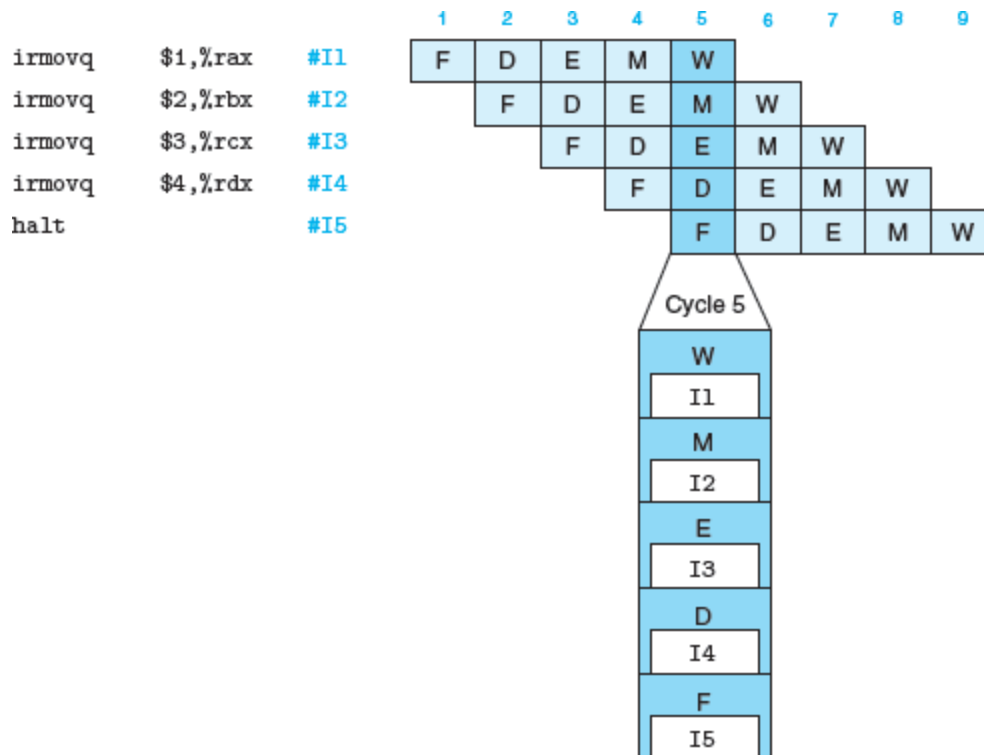
**E** sits between the decode and execute stages. It holds information about the most recently decoded instruction and the values read from the register file for processing by the execute stage.

**M** sits between the execute and memory stages. It holds the results of the most recently executed instruction for processing by the memory stage. It also holds information about branch conditions and branch targets for processing conditional jumps.

**W** sits between the memory stage and the feedback paths that supply the computed results to the register file for writing and the return address to the PC selection logic when completing a `ret` instruction.

**Figure 4.42**  shows how the following code sequence would flow through our five-stage pipeline, where the comments identify the instructions as `I1` to `I5` for reference:

```
1    irmovq  $1,%rax # I1
2    irmovq  $2,%rbx # I2
3    irmovq  $3,%rcx # I3
4    irmovq  $4,%rdx # I4
5    halt                    #I5
```




**Figure 4.42** Example of instruction flow through pipeline.

The right side of the figure shows a pipeline diagram for this instruction sequence. As with the pipeline diagrams for the simple pipelined computation units of [Section 4.4](#), this diagram shows the progression of each instruction through the pipeline stages, with time increasing from left to right. The numbers along the top identify the clock cycles at which the different stages occur. For example, in cycle 1, instruction [I1](#) is fetched, and it then proceeds through the pipeline stages, with its result being written to the register file after the end of cycle 5. Instruction [I2](#) is fetched in cycle 2, and its result is written back after the end of cycle 6, and so on. At the bottom, we show an expanded view of the pipeline for cycle 5. At this point, there is an instruction in each of the pipeline stages.

From [Figure 4.42](#), we can also justify our convention of drawing processors so that the instructions flow from bottom to top. The expanded view for cycle 5 shows the pipeline stages with the fetch stage on the bottom and the write-back stage on the top, just as do our diagrams of the pipeline hardware ([Figure 4.41](#)). If we look at the ordering of instructions in the pipeline stages, we see that they appear in the same order as they do in the program listing. Since normal program flow goes from top to bottom of a listing, we preserve this ordering by having the pipeline flow go from bottom to top. This convention is particularly useful when working with the simulators that accompany this text.

## 4.5.3 Rearranging and Relabeling Signals

Our sequential implementations SEQ and SEQ+ only process one instruction at a time, and so there are unique values for signals such as valC, srcA, and valE. In our pipelined design, there will be multiple versions of these values associated with the different instructions flowing through the system. For example, in the detailed structure of PIPE—, there are four white boxes labeled "Stat" that hold the status codes for four different instructions (see [Figure 4.41](#) ). We need to take great care to make sure we use the proper version of a signal, or else we could have serious errors, such as storing the result computed for one instruction at the destination register specified by another instruction. We adopt a naming scheme where a signal stored in a pipeline register can be uniquely identified by prefixing its name with that of the pipe register written in uppercase. For example, the four status codes are named D\_stat, E\_stat, M\_stat, and W\_stat. We also need to refer to some signals that have just been computed within a stage. These are labeled by prefixing the signal name with the first character of the stage name, written in lowercase. Using the status codes as examples, we can see control logic blocks labeled "Stat" in the fetch and memory stages. The outputs of these blocks are therefore named f\_stat and m\_stat. We can also see that the actual status of the overall processor Stat is computed by a block in the write-back stage, based on the status value in pipeline register W.

The decode stages of SEQ+ and PIPE— both generate signals `dstE` and `dstM` indicating the destination register for values `valE` and `valM`. In SEQ+, we could connect these signals directly to the address inputs of the register file write ports. With PIPE-, these signals are carried along in the pipeline through the execute and memory stages and are directed to the register file only once they reach

## Aside What is the difference between signals `M_stat` and `m_stat`?

With our naming system, the uppercase prefixes ``D'`, ``E'`, ``M'`, and ``W` refer to pipeline *registers*, and so `M_stat` refers to the status code field of pipeline register M. The lowercase prefixes ``f'`, ``d'`, ``e'`, ``m'`, and ``w'` refer to the pipeline *stages*, and so `m_stat` refers to the status signal generated in the memory stage by a control logic block.

Understanding this naming convention is critical to understanding the operation of our pipelined processors.

the write-back stage (shown in the more detailed views of the stages). We do this to make sure the write port address and data inputs hold values from the same instruction. Otherwise, the write back would be writing the values for the instruction in the write-back stage, but with register IDs from the instruction in the decode stage. As a general principle, we want to keep all of the information about a particular instruction contained within a single pipeline stage.

One block of PIPE— that is not present in SEQ+ in the exact same form is the block labeled "Select A" in the decode stage. We can see that this block generates the value valA for the pipeline register E by choosing either valP from pipeline register D or the value read from the A port of the register file. This block is included to reduce the amount of state that must be carried forward to pipeline registers E and M. Of all the different instructions, only the `call` requires valP in the memory stage. Only the jump instructions require the value of valP in the execute stage (in the event the jump is not taken). None of these instructions requires a value read from the register file. Therefore, we can reduce the amount of pipeline register state by merging these two signals and carrying them through the pipeline as a single signal valA. This eliminates the need for the block labeled "Data" in SEQ ([Figure 4.23](#)) and SEQ+ ([Figure 4.40](#)), which served a similar purpose. In hardware design, it is common to carefully identify how signals get used and then reduce the amount of register state and wiring by merging signals such as these.

As shown in [Figure 4.41](#), our pipeline registers include a field for the status code stat, initially computed during the fetch stage and possibly modified during the memory stage. We will discuss how to implement the processing of exceptional events in [Section 4.5.6](#), after we have covered the implementation of normal instruction execution. Suffice it to say at this point that the most systematic approach is to associate a status code with each instruction as it passes through the pipeline, as we have indicated in the figure.



## 4.5.4 Next PC Prediction

We have taken some measures in the design of PIPE— to properly handle control dependencies. Our goal in the pipelined design is to *issue* a new instruction on every clock cycle, meaning that on each clock cycle, a new instruction proceeds into the execute stage and will ultimately be completed. Achieving this goal would

## Aside Other branch prediction strategies

Our design uses an *always taken* branch prediction strategy. Studies show this strategy has around a 60% success rate [44, 122]. Conversely, a *never taken* (NT) strategy has around a 40% success rate. A slightly more sophisticated strategy, known as *backward taken, forward not taken* (BTFNT), predicts that branches to lower addresses than the next instruction will be taken, while those to higher addresses will not be taken. This strategy has a success rate of around 65%. This improvement stems from the fact that loops are closed by backward branches and loops are generally executed multiple times. Forward branches are used for conditional operations, and these are less likely to be taken. In Problems 4.55 and 4.56, you can modify the Y86-64 pipeline processor to implement the NT and BTFNT branch prediction strategies.

As we saw in [Section 3.6.6](#), mispredicted branches can degrade the performance of a program considerably, thus motivating the use of conditional data transfer rather than conditional control transfer when possible.

yield a throughput of one instruction per cycle. To do this, we must determine the location of the next instruction right after fetching the current instruction. Unfortunately, if the fetched instruction is a conditional branch, we will not know whether or not the branch should be taken until several cycles later, after the instruction has

passed through the execute stage. Similarly, if the fetched instruction is a `ret`, we cannot determine the return location until the instruction has passed through the memory stage.

With the exception of conditional jump instructions and `ret`, we can determine the address of the next instruction based on information computed during the fetch stage. For `call` and `jmp` (unconditional jump), it will be `valC`, the constant word in the instruction, while for all others it will be `valP`, the address of the next instruction. We can therefore achieve our goal of issuing a new instruction every clock cycle in most cases by *predicting* the next value of the PC. For most instruction types, our prediction will be completely reliable. For conditional jumps, we can predict either that a jump will be taken, so that the new PC value would be `valC`, or that it will not be taken, so that the new PC value would be `valP`. In either case, we must somehow deal with the case where our prediction was incorrect and therefore we have fetched and partially executed the wrong instructions. We will return to this matter in [Section 4.5.8](#).

This technique of guessing the branch direction and then initiating the fetching of instructions according to our guess is known as *branch prediction*. It is used in some form by virtually all processors. Extensive experiments have been conducted on effective strategies for predicting whether or not branches will be taken [[46, Section 2.3](#)]. Some systems devote large amounts of hardware to this task. In our design, we will use the simple strategy of predicting that conditional branches are always taken, and so we predict the new value of the PC to be `valC`.

We are still left with predicting the new PC value resulting from a `ret` instruction. Unlike conditional jumps, we have a nearly unbounded set of possible

## Aside Return address prediction with a stack

With most programs, it is very easy to predict return addresses, since procedure calls and returns occur in matched pairs. Most of the time that a procedure is called, it returns to the instruction following the call. This property is exploited in high-performance processors by including a hardware stack within the instruction fetch unit that holds the return address generated by procedure call instructions.

Every time a procedure call instruction is executed, its return address is pushed onto the stack. When a return instruction is fetched, the top value is popped from this stack and used as the predicted return address. Like branch prediction, a mechanism must be provided to recover when the prediction was incorrect, since there are times when calls and returns do not match. In general, the prediction is highly reliable. This hardware stack is not part of the programmer-visible state.

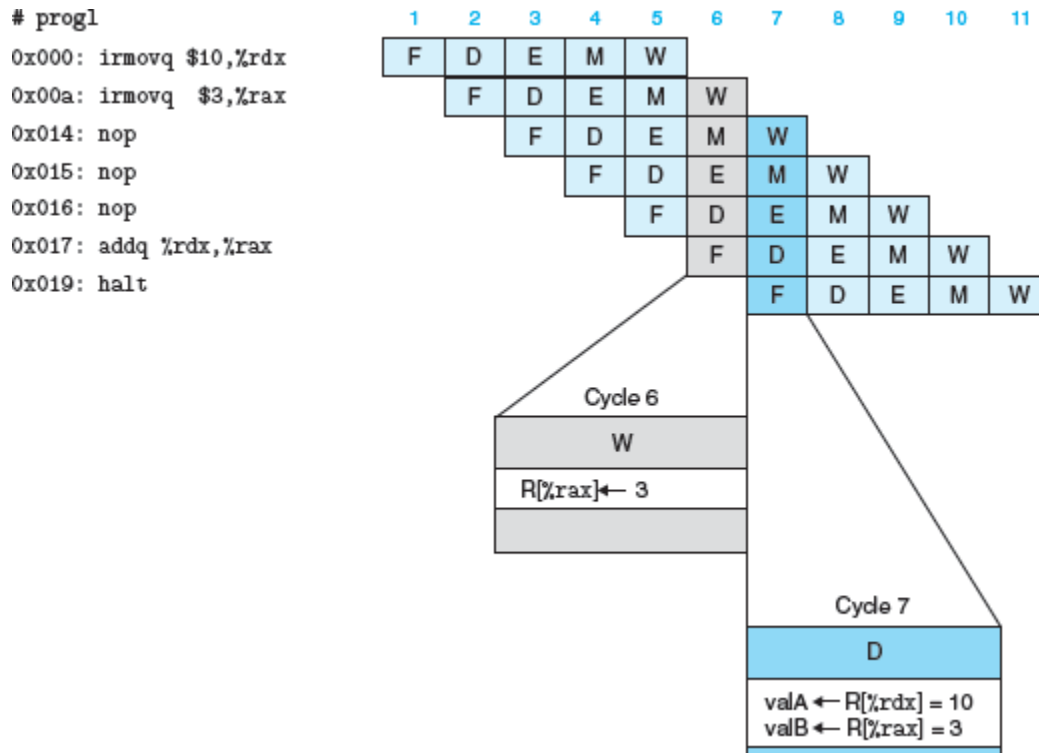
results, since the return address will be whatever word is on the top of the stack. In our design, we will not attempt to predict any value for the return address. Instead, we will simply hold off processing any more instructions until the `ret` instruction passes through the

write-back stage. We will return to this part of the implementation in [Section 4.5.8](#).

The PIPE— fetch stage, diagrammed at the bottom of [Figure 4.41](#), is responsible for both predicting the next value of the PC and selecting the actual PC for the instruction fetch. We can see the block labeled "Predict PC" can choose either valP (as computed by the PC incrementer) or valC (from the fetched instruction). This value is stored in pipeline register F as the *predicted* value of the program counter. The block labeled "Select PC" is similar to the block labeled "PC" in the SEQ+ PC selection stage ([Figure 4.40](#)). It chooses one of three values to serve as the address for the instruction memory: the predicted PC, the value of valP for a not-taken branch instruction that reaches pipeline register M (stored in register M\_valA), or the value of the return address when a `ret` instruction reaches pipeline register W (stored in W\_valM).

## 4.5.5 Pipeline Hazards

Our structure PIPE— is a good start at creating a pipelined Y86-64 processor. Recall from our discussion in [Section 4.4.4](#), however, that introducing pipelining into a system with feedback can lead to problems when there are dependencies between successive instructions. We must resolve this issue before we can complete our design. These dependencies can take two forms: (1) *data* dependencies, where the results computed by one instruction are used as the data for a following instruction, and (2) *control* dependencies, where one instruction determines the location of the following instruction, such as when executing a jump, call, or return. When such dependencies have the potential to cause an erroneous computation by the pipeline, they are called *hazards*. Like dependencies, hazards can be classified as either *data hazards* or *control hazards*. We first concern ourselves with data hazards and then consider control hazards.



**Figure 4.43** Pipelined execution of `prog1` without special pipeline control.

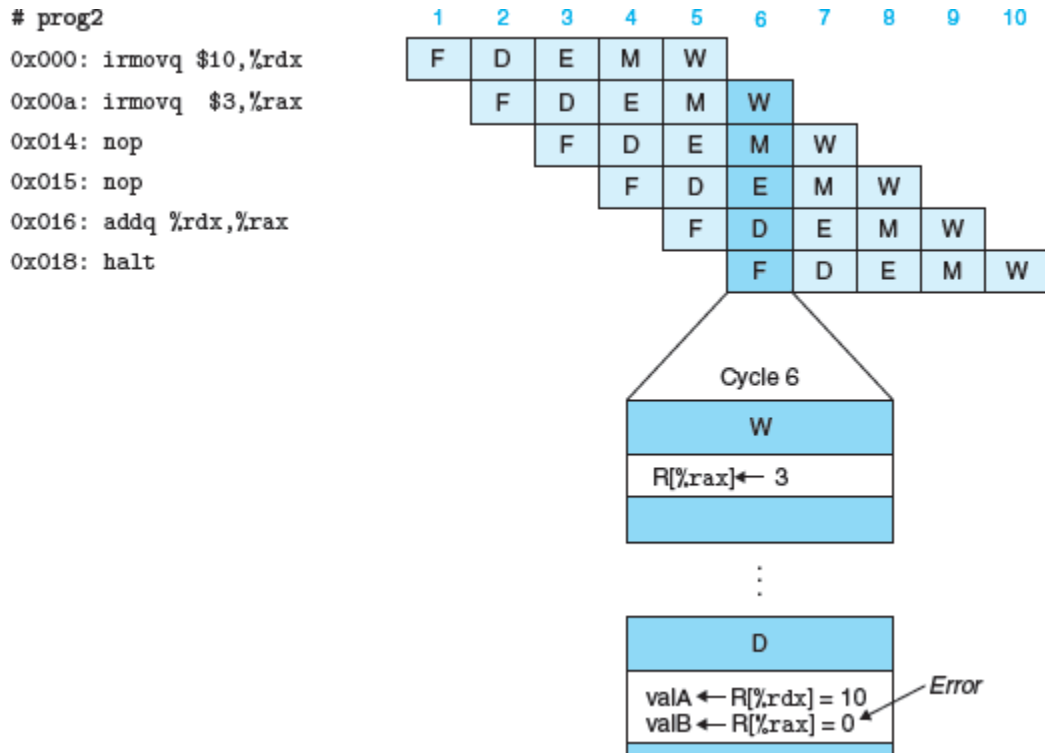
In cycle 6, the second `irmovq` writes its result to program register `%rax`. The `addq` instruction reads its source operands in cycle 7, so it gets correct values for both `%rdx` and `%rax`.

**Figure 4.43** illustrates the processing of a sequence of instructions we refer to as `prog1` by the PIPE—processor. Let us assume in this example and successive ones that the program registers initially all have value 0. The code loads values 10 and 3 into program registers `%rdx` and `%rax`, executes three `nop` instructions, and then adds register `%rdx` to `%rax`. We focus our attention on the potential data hazards resulting from the data

dependencies between the two `irmovq` instructions and the `addq` instruction. On the right-hand side of the figure, we show a pipeline diagram for the instruction sequence. The pipeline stages for cycles 6 and 7 are shown highlighted in the pipeline diagram. Below this, we show an expanded view of the write-back activity in cycle 6 and the decode activity during cycle 7. After the start of cycle 7, both of the `irmovq` instructions have passed through the write back stage, and so the register file holds the updated values of `%rdx` and `%rax`. As the `addq` instruction passes through the decode stage during cycle 7, it will therefore read the correct values for its source operands. The data dependencies between the two `irmovq` instructions and the `addq` instruction have not created data hazards in this example.

We saw that `prog1` will flow through our pipeline and get the correct results, because the three `nop` instructions create a delay between instructions with data






**Figure 4.44 Pipelined execution of `prog2` without special pipeline control.**

The write to program register `%rax` does not occur until the start of cycle 7, and so the `addq` instruction gets the incorrect value for this register in the decode stage.

dependencies. Let us see what happens as these `nop` instructions are removed. [Figure 4.44](#) illustrates the pipeline flow of a program, named `prog2`, containing two `nop` instructions between the two `irmovq` instructions generating values for registers `%rdx` and `%rax` and the `addq` instruction having these two registers as operands. In this case, the crucial step occurs in cycle 6, when the `addq` instruction reads its operands from the register file. An

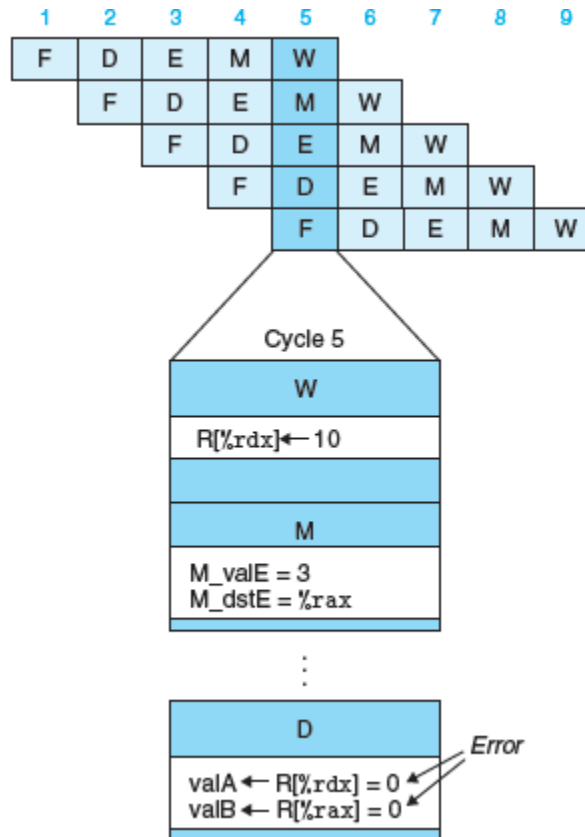
expanded view of the pipeline activities during this cycle is shown at the bottom of the figure. The first `irmovq` instruction has passed through the write-back stage, and so program register `%rdx` has been updated in the register file. The second `irmovq` instruction is in the write-back stage during this cycle, and so the write to program register `%rax` only occurs at the start of cycle 7 as the clock rises. As a result, the incorrect value zero would be read for register `%rax` (recall that we assume all registers are initially zero), since the pending write for this register has not yet occurred. Clearly, we will have to adapt our pipeline to handle this hazard properly.

**Figure 4.45**  shows what happens when we have only one `nop` instruction between the `irmovq` instructions and the `addq` instruction, yielding a program `prog3`. Now we must examine the behavior of the pipeline during cycle 5 as the `addq` instruction passes through the decode stage. Unfortunately, the pending

```

# prog3
0x000: irmovq $10,%rdx
0x00a: irmovq $3,%rax
0x014: nop
0x015: addq %rdx,%rax
0x017: halt


```



**Figure 4.45 Pipelined execution of `prog3` without special pipeline control.**

In cycle 5, the `addq` instruction reads its source operands from the register file. The pending write to register `%rdx` is still in the write-back stage, and the pending write to register `%rax` is still in the memory stage. Both operands `valA` and `valB` get incorrect values.

write to register `%rdx` is still in the write-back stage, and the pending write to `%rax` is still in the memory stage. Therefore, the `addq` instruction would get the incorrect values for both operands.

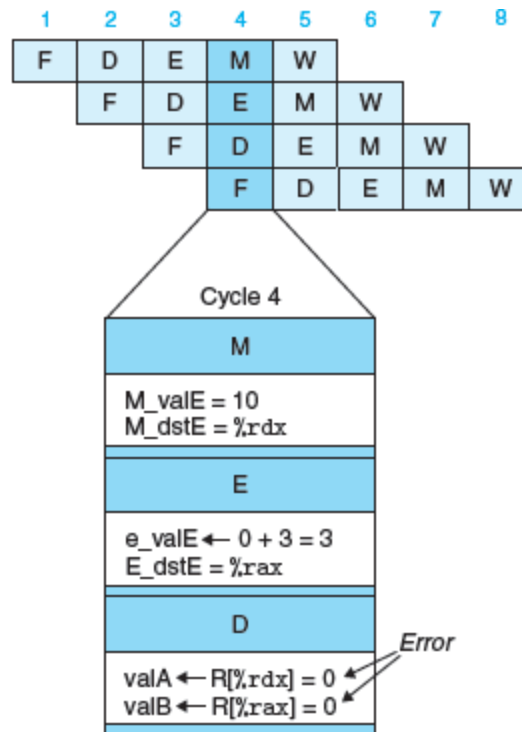
**Figure 4.46**  shows what happens when we remove all of the `nop` instructions between the `irmovq` instructions and the `addq` instruction, yielding a program `prog4`. Now we must examine the behavior of the pipeline during cycle 4 as the `addq` instruction passes through the decode stage. Unfortunately, the pending write to register `%rdx` is still in the memory stage, and the new value for `%rax` is just being computed in the execute stage. Therefore, the `addq` instruction would get the incorrect values for both operands.

These examples illustrate that a data hazard can arise for an instruction when one of its operands is updated by any of the three preceding instructions. These hazards occur because our pipelined processor reads the operands for an instruction from the register file in the decode stage but does not write the results for the instruction to the register file until three cycles later, after the instruction passes through the write-back stage.

```

# prog4
0x000: irmovq $10,%rdx
0x00a: irmovq $3,%rax
0x014: addq %rdx,%rax
0x016: halt

```



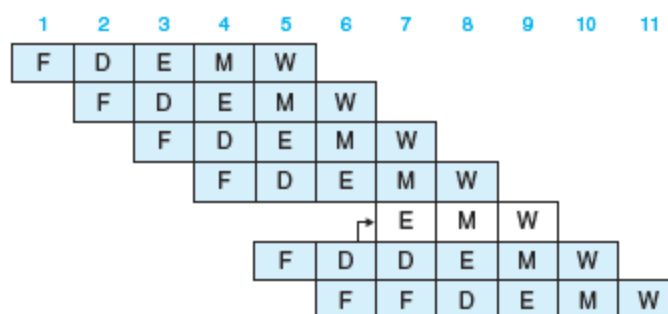
**Figure 4.46 Pipelined execution of `prog4` without special pipeline control.**

In cycle 4, the `addq` instruction reads its source operands from the register file. The pending write to register `%rdx` is still in the memory stage, and the new value for register `%rax` is just being computed in the execute stage. Both operands `valA` and `valB` get incorrect values.

# Avoiding Data Hazards by Stalling


One very general technique for avoiding hazards involves *stalling*, where the processor holds back one or more instructions in the pipeline until the hazard condition no longer holds. Our processor can avoid data hazards by holding back an instruction in the decode stage until the instructions generating its source operands have passed through the write-back stage. The details of this mechanism will be discussed in [Section 4.5.8](#). It involves simple enhancements to the pipeline control logic. The effect of stalling is diagrammed in [Figure 4.47](#) (`prog2`) and [Figure 4.48](#) (`prog4`). (We omit `prog3` from this discussion, since it operates similarly to the other two examples.) When the `addq` instruction is in the decode stage, the pipeline control logic detects that at least one of the instructions in the execute, memory, or write-back stage will update either register `%rdx` or register `%rax`. Rather than letting the `addq` instruction pass through the stage with the incorrect results, it stalls the instruction, holding it back in the decode stage for either one (for `prog2`) or three (for `prog4`) extra cycles. For all three programs, the `addq` instruction finally gets correct values for its two source operands in cycle 7 and then proceeds down the pipeline.

```
# prog2
0x000: irmovq $10,%rdx
0x00a: irmovq $3,%rax
0x014: nop
0x015: nop
      bubble
0x016: addlq %rdx,%rax
0x018: halt
```

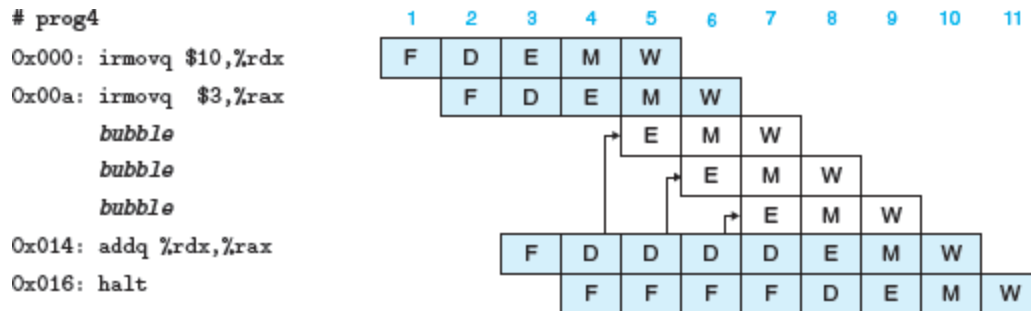


[OceanofPDF.com](http://OceanofPDF.com)

**Figure 4.47 Pipelined execution of `prog2` using stalls.**

After decoding the `addq` instruction in cycle 6, the stall control logic detects a data hazard due to the pending write to register `%rax` in the write-back stage. It injects a bubble into the execute stage and repeats the decoding of the `addq` instruction in cycle 7. In effect, the machine has dynamically inserted a `nop` instruction, giving a flow similar to that shown for `prog1` ([Figure 4.43](#) )





**Figure 4.48** Pipelined execution of `prog4` using stalls.

After decoding the `addq` instruction in cycle 4, the stall control logic detects data hazards for both source registers. It injects a bubble into the execute stage and repeats the decoding of the `addq` instruction on cycle 5. It again detects hazards for both source registers, injects a bubble into the execute stage, and repeats the decoding of the `addq` instruction on cycle 6. Still, it detects a hazard for source register `%rax`, injects a bubble into the execute stage, and repeats the decoding of the `addq` instruction on cycle 7. In effect, the machine has dynamically inserted three `nop` instructions, giving a flow similar to that shown for `prog1` (Figure 4.43).

In holding back the `addq` instruction in the decode stage, we must also hold back the `halt` instruction following it in the fetch stage. We can do this by keeping the program counter at a fixed value, so that the `halt` instruction will be fetched repeatedly until the stall has completed.


Stalling involves holding back one group of instructions in their stages while allowing other instructions to continue flowing through

the pipeline. What then should we do in the stages that would normally be processing the `addq` instruction? We handle these by injecting a *bubble* into the execute stage each time we hold an instruction back in the decode stage. A bubble is like a dynamically generated `nop` instruction—it does not cause any changes to the registers, the memory, the

# Aside Enumerating classes of data hazards

Hazards can potentially occur when one instruction updates part of the program state that will be read by a later instruction. For Y86-64, the program state includes the program registers, the program counter, the memory, the condition code register, and the status register. Let us look at the hazard possibilities in our proposed design for each of these forms of state.

**Program registers.** These are the hazards we have already identified. They arise because the register file is read in one stage and written in another, leading to possible unintended interactions between different instructions.

**Program counter.** Conflicts between updating and reading the program counter give rise to control hazards. No hazard arises when our fetch-stage logic correctly predicts the new value of the program counter before fetching the next instruction. Mispredicted branches and `ret` instructions require special handling, as will be discussed in [Section 4.5.5](#) .

**Memory.** Writes and reads of the data memory both occur in the memory stage. By the time an instruction reading memory reaches this stage, any preceding instructions

writing memory will have already done so. On the other hand, there can be interference between instructions writing data in the memory stage and the reading of instructions in the fetch stage, since the instruction and data memories reference a single address space. This can only happen with programs containing *self-modifying code*, where instructions write to a portion of memory from which instructions are later fetched. Some systems have complex mechanisms to detect and avoid such hazards, while others simply mandate that programs should not use self-modifying code. We will assume for simplicity that programs do not modify themselves, and therefore we do not need to take special measures to update the instruction memory based on updates to the data memory during program execution.

**Condition code register.** These are written by integer operations in the execute stage. They are read by conditional moves in the execute stage and by conditional jumps in the memory stage. By the time a conditional move or jump reaches the execute stage, any preceding integer operation will have already completed this stage. No hazards can arise.

**Status register.** The program status can be affected by instructions as they flow through the pipeline. Our mechanism of associating a status code with each instruction in the pipeline enables the processor to come

to an orderly halt when an exception occurs, as will be discussed in [Section 4.5.6](#).

This analysis shows that we only need to deal with register data hazards, control hazards, and making sure exceptions are handled properly. A systematic analysis of this form is important when designing a complex system. It can identify the potential difficulties in implementing the system, and it can guide the generation of test programs to be used in checking the correctness of the system.


condition codes, or the program status. These are shown as white boxes in the pipeline diagrams of [Figures 4.47](#) and [4.48](#). In these figures the arrow between the box labeled "D" for the `addq` instruction and the box labeled "E" for one of the pipeline bubbles indicates that a bubble was injected into the execute stage in place of the `addq` instruction that would normally have passed from the decode to the execute stage. We will look at the detailed mechanisms for making the pipeline stall and for injecting bubbles in [Section 4.5.8](#).

In using stalling to handle data hazards, we effectively execute programs `prog2` and `prog4` by dynamically generating the pipeline flow seen for `prog1` ([Figure 4.43](#)). Injecting one bubble for `prog2` and three for `prog4` has the same effect as having three `nop` instructions between the second `irmovq` instruction and the `addq` instruction. This mechanism can be implemented fairly easily (see [Problem 4.53](#)), but the resulting performance is not very good. There are numerous cases in which one instruction updates a

register and a closely following instruction uses the same register. This will cause the pipeline to stall for up to three cycles, reducing the overall throughput significantly.

## *Avoiding Data Hazards by Forwarding*

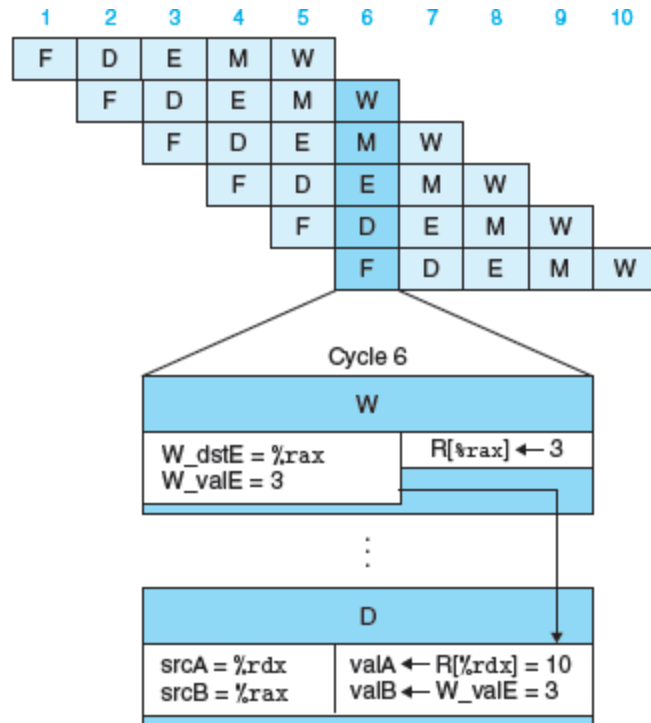
Our design for PIPE— reads source operands from the register file in the decode stage, but there can also be a pending write to one of these source registers in the write-back stage. Rather than stalling until the write has completed, it can simply pass the value that is about to be written to pipeline register E as the source operand.

**Figure 4.49**  shows this strategy with an expanded view of the pipeline diagram for cycle 6 of `prog2`. The decode-stage logic detects that register

```

# prog2
0x000: irmovq $10,%rdx
0x00a: irmovq $3,%rax
0x014: nop
0x015: nop
0x016: addq %rdx,%rax
0x018: halt

```



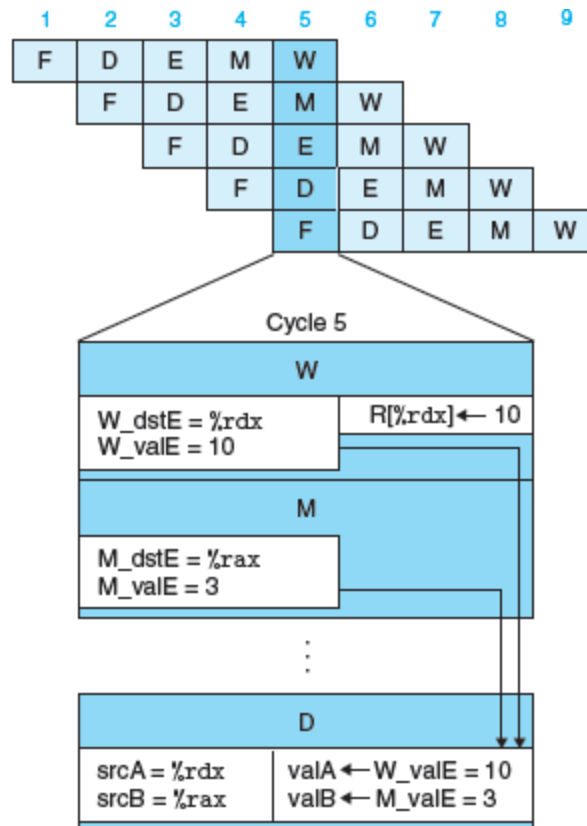
**Figure 4.49 Pipelined execution of `prog2` using forwarding.** In cycle 6, the decode-stage logic detects the presence of a pending write to register `%rax` in the write-back stage. It uses this value for source operand `valB` rather than the value read from the register file.



```

# prog3
0x000: irmovq $10,%rdx
0x00a: irmovq $3,%rax
0x014: nop
0x005: addq %rdx,%rax
0x017: halt

```




**Figure 4.50** Pipelined execution of `prog3` using forwarding.

In cycle 5, the decode-stage logic detects a pending write to register `%rdx` in the write-back stage and to register `%rax` in the memory stage. It uses these as the values for `valA` and `valB` rather than the values read from the register file.

`%rax` is the source register for operand `valB`, and that there is also a pending write to `%rax` on write port E. It can therefore avoid stalling by simply using the data word supplied to port E (signal `W_valE`) as the value for operand `valB`. This technique of passing a result value directly from one pipeline stage to an earlier one is commonly known as *data forwarding* (or simply *forwarding*, and sometimes *bypassing*).

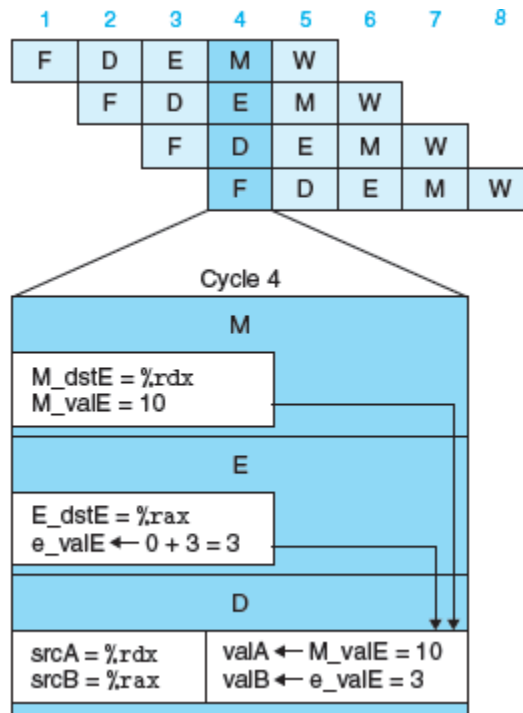
It allows the instructions of `prog2` to proceed through the pipeline without any stalling. Data forwarding requires adding additional data connections and control logic to the basic hardware structure.

As **Figure 4.50**  illustrates, data forwarding can also be used when there is a pending write to a register in the memory stage, avoiding the need to stall for program `prog3`. In cycle 5, the decode-stage logic detects a pending write to register `%rdx` on port E in the write-back stage, as well as a pending write to register `%rax` that is on its way to port E but is still in the memory stage. Rather than stalling until the writes have occurred, it can use the value in the write-back stage (signal `W_valE`) for operand `valA` and the value in the memory stage (signal `M_valE`) for operand `valB`.

```

# prog4
0x000: irmovq $10,%rdx
0x00a: irmovq $3,%rax
0x014: addq %rdx,%rax
0x016: halt

```



**Figure 4.51** Pipelined execution of `prog4` using forwarding.



In cycle 4, the decode-stage logic detects a pending write to register `%rdx` in the memory stage. It also detects that a new value is being computed for register `%rax` in the execute stage. It uses these as the values for `valA` and `valB` rather than the values read from the register file.

To exploit data forwarding to its full extent, we can also pass newly computed values from the execute stage to the decode stage, avoiding the need to stall for program `prog4`, as illustrated in [Figure 4.51](#). In cycle 4, the decode-stage logic detects a pending write to register `%rdx` in the memory stage, and also that the value being computed by the ALU in the execute stage will later be written to register `%rax`. It can use the value in the memory stage (signal


M\_valE) for operand valA. It can also use the ALU output (signal e\_valE) for operand valB. Note that using the ALU output does not introduce any timing problems. The decode stage only needs to generate signals valA and valB by the end of the clock cycle so that pipeline register E can be loaded with the results from the decode stage as the clock rises to start the next cycle. The ALU output will be valid before this point.


The uses of forwarding illustrated in programs `prog2` to `prog4` all involve the forwarding of values generated by the ALU and destined for write port E. Forwarding can also be used with values read from the memory and destined for write port M. From the memory stage, we can forward the value that has just been read from the data memory (signal m\_valM). From the write-back stage, we can forward the pending write to port M (signal W\_valM). This gives a total of five different forwarding sources (e\_valE, m\_valM, M\_valE, W\_valM, and W\_valE) and two different forwarding destinations (valA and valB).

The expanded diagrams of [Figures 4.49](#) to [4.51](#) also show how the decode-stage logic can determine whether to use a value from the register file or to use a forwarded value. Associated with every value that will be written back to the register file is the destination register ID. The logic can compare these IDs with the source register IDs srcA and srcB to detect a case for forwarding. It is possible to have multiple destination register IDs match one of the source IDs. We must establish a priority among the different forwarding sources to handle such cases. This will be discussed when we look at the detailed design of the forwarding logic.

**Figure 4.52**  shows the structure of PIPE, an extension of PIPE—that can handle data hazards by forwarding. Comparing this to the structure of PIPE—(**Figure 4.41** ) , we can see that the values from the five forwarding sources are fed back to the two blocks labeled "Sel+Fwd A" and "Fwd B" in the decode stage. The block labeled "Sel+Fwd A" combines the role of the block labeled "Select A" in PIPE—with the forwarding logic. It allows valA for pipeline register E to be either the incremented program counter valP, the value read from the A port of the register file, or one of the forwarded values. The block labeled "Fwd B" implements the forwarding logic for source operand valB.

## Load/Use Data Hazards

One class of data hazards cannot be handled purely by forwarding, because memory reads occur late in the pipeline. **Figure 4.53**  illustrates an example of a *load/use hazard*, where one instruction (the `mrmovq` at address `0x028`) reads a value from memory for register `%rax` while the next instruction (the `addq` at address `0x032`) needs this value as a source operand. Expanded views of cycles 7 and 8 are shown in the lower part of the figure, where we assume all program registers initially have value 0. The `addq` instruction requires the value of the register in cycle 7, but it is not generated by the `mrmovq` instruction until cycle 8. In order to "forward" from the `mrmovq` to the `addq`, the forwarding logic would have to make the value go backward in time! Since this is clearly impossible, we must find some other mechanism for handling this form of data hazard. (The data hazard for register `%rbx`, with the value being generated by the `irmovq` instruction at address `0x01e` and used by the `addq` instruction at address `0x032`, can be handled by forwarding.)

As **Figure 4.54**  demonstrates, we can avoid a load/use data hazard with a combination of stalling and forwarding. This requires modifications of the control logic, but it can use existing bypass paths. As the `mrmovq` instruction passes through the execute stage, the pipeline control logic detects that the instruction in the decode stage (the `addq`) requires the result read from memory. It stalls the instruction in the decode stage for one cycle, causing a bubble to be injected into the execute stage. As the expanded view of cycle 8

shows, the value read from memory can then be forwarded from the memory stage to the `addq` instruction in the decode stage. The value for register `%rbx` is also forwarded from the write-back to the memory stage. As indicated in the pipeline diagram by the arrow from the box labeled "D" in cycle 7 to the box labeled "E" in cycle 8, the injected bubble replaces the `addq` instruction that would normally continue flowing through the pipeline.

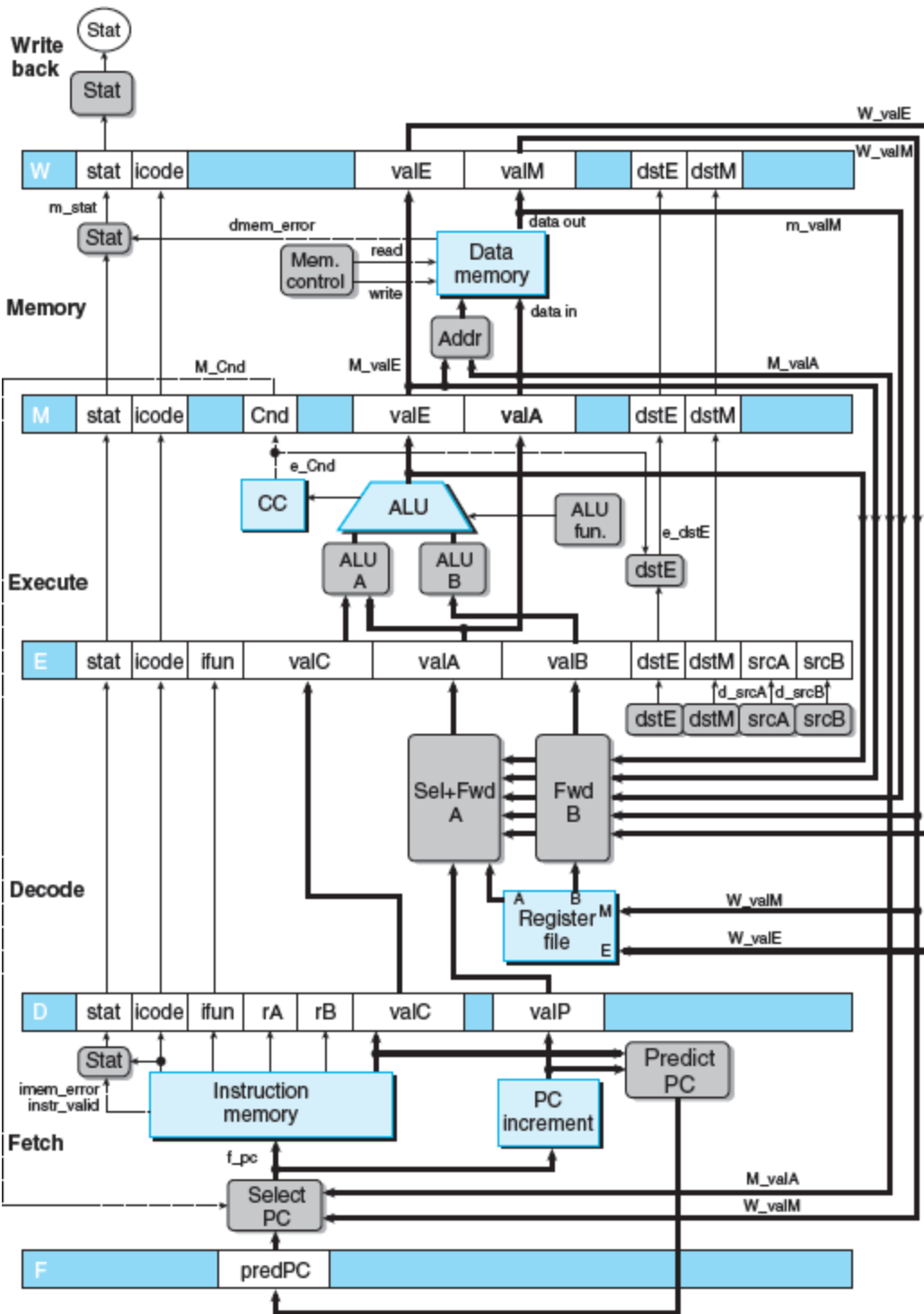
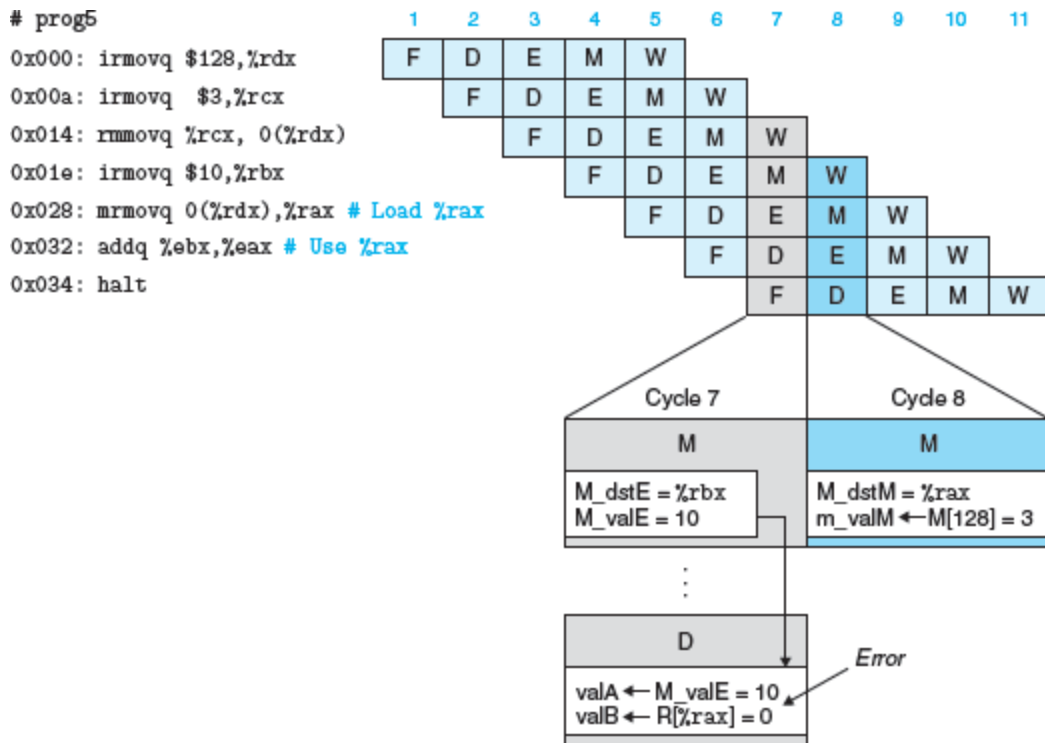


Figure 4.52 Hardware structure of PIPE, our final pipelined implementation.



The additional bypassing paths enable forwarding the results from the three preceding instructions. This allows us to handle most forms of data hazards without stalling the pipeline.



**Figure 4.53 Example of load/use data hazard.**

The `addq` instruction requires the value of register `%rax` during the decode stage in cycle 7. The preceding `mrmovq` reads a new value for this register during the memory stage in cycle 8, which is too late for the `addq` instruction.

This use of a stall to handle a load/use hazard is called a *load interlock*. Load interlocks combined with forwarding suffice to handle all possible forms of data hazards. Since only load interlocks reduce

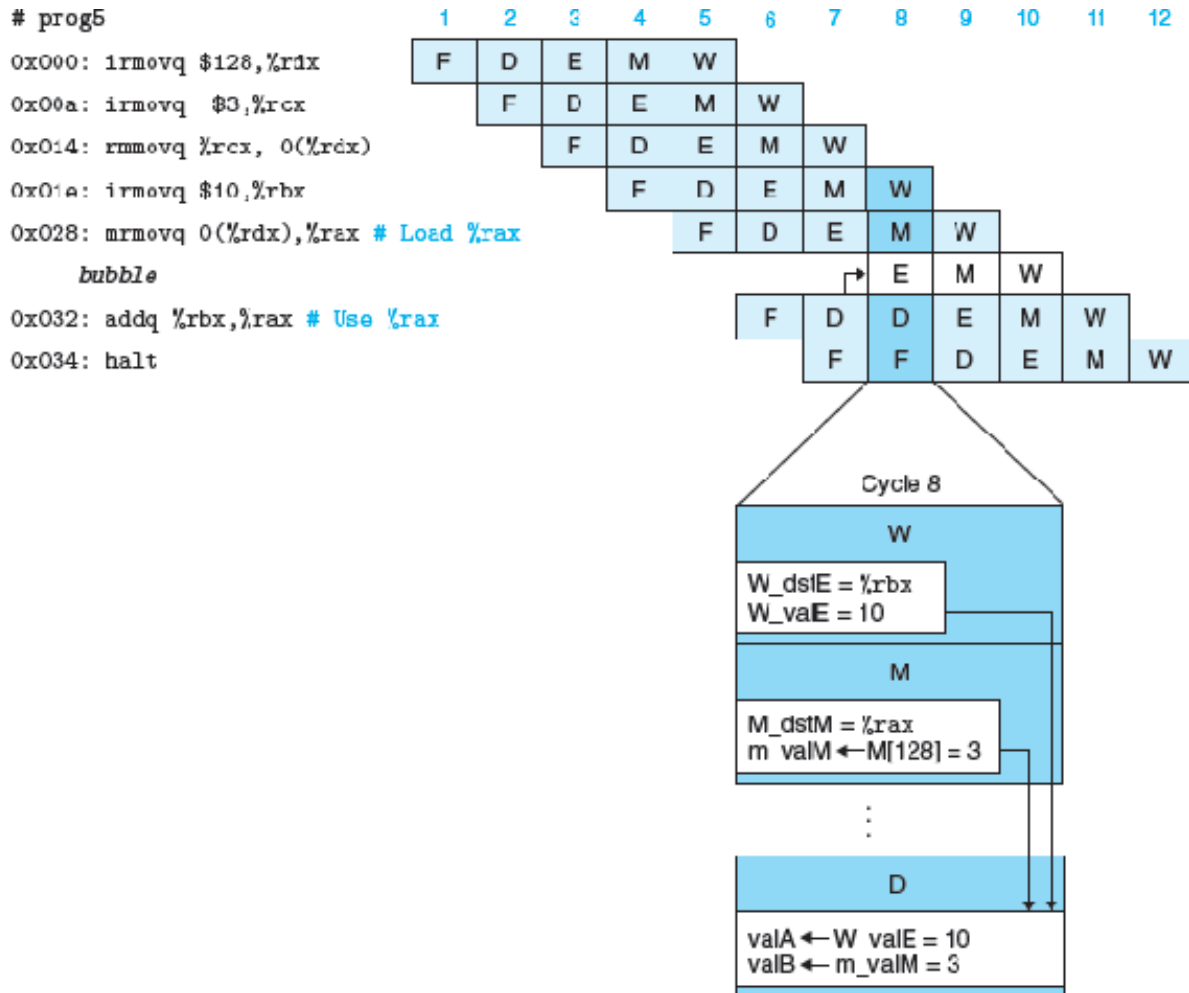
the pipeline throughput, we can nearly achieve our throughput goal of issuing one new instruction on every clock cycle.

## *Avoiding Control Hazards*

Control hazards arise when the processor cannot reliably determine the address of the next instruction based on the current instruction in the fetch stage. As was discussed in [Section 4.5.4](#), control hazards can only occur in our pipelined processor for `ret` and jump instructions. Moreover, the latter case only causes difficulties when the direction of a conditional jump is mispredicted. In this section, we provide a high-level view of how these hazards can be handled. The detailed implementation will be presented in [Section 4.5.8](#) as part of a more general discussion of the pipeline control.

For the `ret` instruction, consider the following example program.

This program is shown in assembly code, but with the addresses of the different instructions on the left for reference:




**Figure 4.54 Handling a load/use hazard by stalling.**

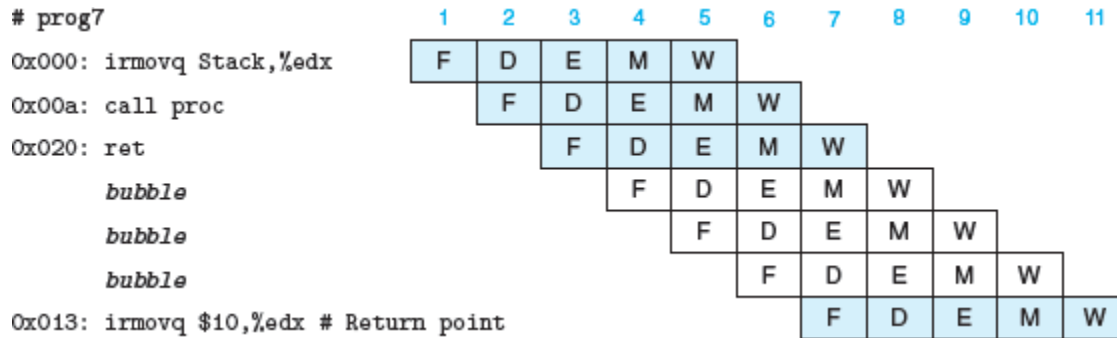
By stalling the `addq` instruction for one cycle in the decode stage, the value for `valB` can be forwarded from the `mrmovq` instruction in the memory stage to the `addq` instruction in the decode stage.

```

0x000:  irmovq stack,%rsp          # Initialize stack
pointer
0x00a:  call proc                   # Procedure call
0x013:  irmovq $10,%rdx           # Return point
0x01d:  halt
0x020:  .pos 0x20
0x020:  proc:                       # proc:
0x020:  ret                         # Return immediately
0x021:  rrmovq %rdx,%rbx          # Not executed
0x030:  .pos 0x30
0x030:  stack:                      # stack: Stack pointer

```

**Figure 4.55**  shows how we want the pipeline to process the `ret` instruction. As with our earlier pipeline diagrams, this figure shows the pipeline activity with



**Figure 4.55 Simplified view of `ret` instruction processing.**

The pipeline should stall while the `ret` passes through the decode, execute, and memory stages, injecting three bubbles in the process. The PC selection logic will choose the return address as the instruction fetch address once the `ret` reaches the write-back stage (cycle 7).


time growing to the right. Unlike before, the instructions are not listed in the same order they occur in the program, since this program involves a control flow where instructions are not executed in a linear sequence. It is useful to look at the instruction addresses to identify the different instructions in the program.

As this diagram shows, the `ret` instruction is fetched during cycle 3 and proceeds down the pipeline, reaching the write-back stage in cycle 7. While it passes through the decode, execute, and memory stages, the pipeline cannot do any useful activity. Instead, we want to inject three bubbles into the pipeline. Once the `ret` instruction reaches the write-back stage, the PC selection logic will set the

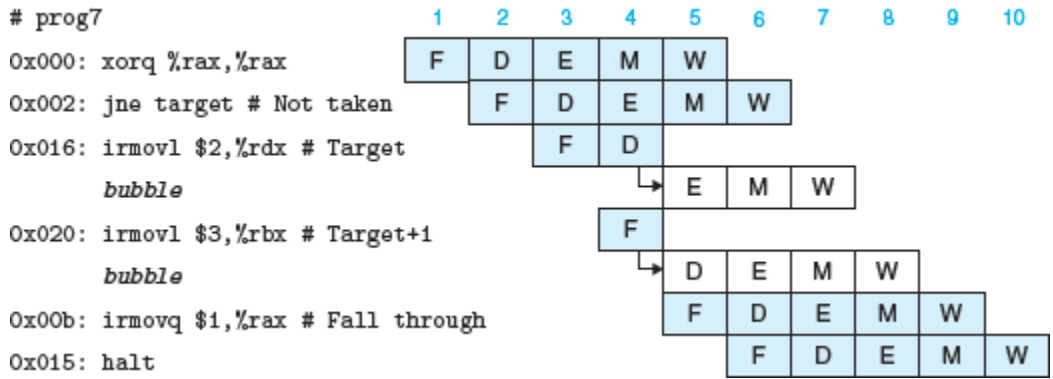
program counter to the return address, and therefore the fetch stage will fetch the `irmovq` instruction at the return point (address `0x013`).

To handle a mispredicted branch, consider the following program, shown in assembly code but with the instruction addresses shown on the left for reference:

```
0x000: xorq %rax,%rax
0x002: jne target      # Not taken
0x00b: irmovq $1, %rax # Fall through
0x015: halt
0x016: target:
0x016: irmovq $2, %rdx # Target
0x020: irmovq $3, %rbx # Target+1
0x02a: halt
```

**Figure 4.56**  shows how these instructions are processed. As before, the instructions are listed in the order they enter the pipeline, rather than the order they occur in the program. Since the jump instruction is predicted as being taken, the instruction at the jump target will be fetched in cycle 3, and the instruction following this one will be fetched in cycle 4. By the time the branch logic detects that the jump should not be taken during cycle 4, two instructions have been fetched that should not continue being executed. Fortunately,

neither of these instructions has caused a change in the programmer-visible state. That can only occur when an instruction



**Figure 4.56 Processing mispredicted branch instructions.**

The pipeline predicts branches will be taken and so starts fetching instructions at the jump target. Two instructions are fetched before the misprediction is detected in cycle 4 when the jump instruction flows through the execute stage. In cycle 5, the pipeline *cancel*s the two target instructions by injecting bubbles into the decode and execute stages, and it also fetches the instruction following the jump.

reaches the execute stage, where it can cause the condition codes to change. At this point, the pipeline can simply *cancel* (sometimes called *instruction squashing*) the two misfetched instructions by injecting bubbles into the decode and execute stages on the following cycle while also fetching the instruction following the jump instruction. The two misfetched instructions will then simply disappear from the pipeline and therefore not have any effect on the programmer-visible state. The only drawback is that two clock cycles' worth of instruction processing capability have been wasted.



This discussion of control hazards indicates that they can be handled by careful consideration of the pipeline control logic. Techniques such as stalling and injecting bubbles into the pipeline dynamically adjust the pipeline flow when special conditions arise. As we will discuss in [Section 4.5.8](#), a simple extension to the basic clocked register design will enable us to stall stages and to inject bubbles into pipeline registers as part of the pipeline control logic.

## 4.5.6 Exception Handling

As we will discuss in [Chapter 8](#), a variety of activities in a processor can lead to *exceptional control flow*, where the normal chain of program execution gets broken. Exceptions can be generated either *internally*, by the executing program, or *externally*, by some outside signal. Our instruction set architecture includes three different internally generated exceptions, caused by (1) a halt instruction, (2) an instruction with an invalid combination of instruction and function code, and (3) an attempt to access an invalid address, either for instruction fetch or data read or write. A more complete processor design would also handle external exceptions, such as when the processor receives a signal that the network interface has received a new packet or the user has clicked a mouse button. Handling exceptions correctly is a challenging aspect of any microprocessor design. They can occur at unpredictable times, and they require creating a clean break in the flow of instructions through the processor pipeline. Our handling of the three internal exceptions gives just a glimpse of the true complexity of correctly detecting and handling exceptions.

Let us refer to the instruction causing the exception as the *excepting instruction*. In the case of an invalid instruction address, there is no actual excepting instruction, but it is useful to think of there being a sort of "virtual instruction" at the invalid address. In our simplified ISA model, we want the processor to halt when it reaches an exception and to set the appropriate status code, as listed in [Figure 4.5](#). It

should appear that all instructions up to the excepting instruction have completed, but none of the following instructions should have any effect on the programmer-visible state. In a more complete design, the processor would continue by invoking an exception handler, a procedure that is part of the operating system, but implementing this part of exception handling is beyond the scope of our presentation.

In a pipelined system, exception handling involves several subtleties. First, it is possible to have exceptions triggered by multiple instructions simultaneously. For example, during one cycle of pipeline operation, we could have a halt instruction in the fetch stage, and the data memory could report an out-of-bounds data address for the instruction in the memory stage. We must determine which of these exceptions the processor should report to the operating system. The basic rule is to put priority on the exception triggered by the instruction that is furthest along the pipeline. In the example above, this would be the out-of-bounds address attempted by the instruction in the memory stage. In terms of the machine-language program, the instruction in the memory stage should appear to execute before one in the fetch stage, and therefore only this exception should be reported to the operating system.

A second subtlety occurs when an instruction is first fetched and begins execution, causes an exception, and later is canceled due to a mispredicted branch. The following is an example of such a program in its object-code form:

```

0x000: 6300                | xorq %rax,%rax
0x002: 7416000000000000    | jne target      # Not taken
0x00b: 30f0010000000000    | irmovq $1, %rax # Fall through
0x015: 00                  | halt
0x016:                  | target:
0x016: ff              | .byte 0xFF      # Invalid
instruction code

```

In this program, the pipeline will predict that the branch should be taken, and so it will fetch and attempt to use a byte with value `0xFF` as an instruction (generated in the assembly code using the `.byte` directive). The decode stage will therefore detect an invalid instruction exception. Later, the pipeline will discover that the branch should not be taken, and so the instruction at address `0x016` should never even have been fetched. The pipeline control logic will cancel this instruction, but we want to avoid raising an exception.

A third subtlety arises because a pipelined processor updates different parts of the system state in different stages. It is possible for an instruction following one causing an exception to alter some part of the state before the excepting instruction completes. For example, consider the following code sequence, in which we assume that user programs are not allowed to access addresses at the upper end of the 64-bit range:

```
1    irmovq $1,%rax
2    xorq %rsp,%rsp # Set stack pointer to 0 and CC to 100
3    pushq %rax     # Attempt to write to 0xffffffffffffff8
4    addq %rax/Zrax # (Should not be executed) would set CC
to 000
```

The `pushq` instruction causes an address exception, because decrementing the stack pointer causes it to wrap around to `0xffffffffffffff8`. This exception is detected in the memory stage. On the same cycle, the `addq` instruction is in the execute stage, and it will cause the condition codes to be set to new values. This would violate our requirement that none of the instructions following the excepting instruction should have had any effect on the system state.

In general, we can both correctly choose among the different exceptions and avoid raising exceptions for instructions that are fetched due to mispredicted branches by merging the exception-handling logic into the pipeline structure. That is the motivation for us to include a status code `stat` in each of our pipeline registers ([Figures 4.41](#) and [4.52](#)). If an instruction generates an exception at some stage in its processing, the status field is set to indicate the nature of the exception. The exception status propagates through the pipeline with the rest of the information for that instruction, until it reaches the write-back stage. At this point, the

pipeline control logic detects the occurrence of the exception and stops execution.

To avoid having any updating of the programmer-visible state by instructions beyond the excepting instruction, the pipeline control logic must disable any updating of the condition code register or the data memory when an instruction in the memory or write-back stages has caused an exception. In the example program above, the control logic will detect that the `pushq` in the memory stage has caused an exception, and therefore the updating of the condition code register by the `addq` instruction in the execute stage will be disabled.

Let us consider how this method of handling exceptions deals with the subtleties we have mentioned. When an exception occurs in one or more stages of a pipeline, the information is simply stored in the status fields of the pipeline registers. The event has no effect on the flow of instructions in the pipeline until an excepting instruction reaches the final pipeline stage, except to disable any updating of the programmer-visible state (the condition code register and the memory) by later instructions in the pipeline. Since instructions reach the write-back stage in the same order as they would be executed in a nonpipelined processor, we are guaranteed that the first instruction encountering an exception will arrive first in the write-back stage, at which point program execution can stop and the status code in pipeline register W can be recorded as the program status. If some instruction is fetched but later canceled, any exception status information about the instruction gets canceled as well. No

instruction following one that causes an exception can alter the programmer-visible state. The simple rule of carrying the exception status together with all other information about an instruction through the pipeline provides a simple and reliable mechanism for handling exceptions.

## 4.5.7 PIPE Stage Implementations

We have now created an overall structure for PIPE, our pipelined Y86-64 processor with forwarding. It uses the same set of hardware units as the earlier sequential designs, with the addition of pipeline registers, some reconfigured logic blocks, and additional pipeline control logic. In this section, we go through the design of the different logic blocks, deferring the design of the pipeline control logic to the next section. Many of the logic blocks are identical to their counterparts in SEQ and SEQ+, except that we must choose proper versions of the different signals from the pipeline registers (written with the pipeline register name, written in uppercase, as a prefix) or from the stage computations (written with the first character of the stage name, written in lowercase, as a prefix).

As an example, compare the HCL code for the logic that generates the `srcA` signal in SEQ to the corresponding code in PIPE:



```

# Code from SEQ
word srcA = [
  icode in { IRRMOVQ, IRMMOVQ, IOPQ, IPUSHQ } : rA;
  icode in { IPOPQ, IRET } : RRSP;
  1 : RNONE; # Don't need register
];

# Code from PIPE
word d_srcA = [
  D_icode in { IRRMOVQ, IRMMOVQ, IOPQ, IPUSHQ } : D_rA;
  D_icode in { IPOPQ, IRET } : RRSP;
  1 : RNONE; # Don't need register
];

```

They differ only in the prefixes added to the PIPE signals: `D_` for the source values, to indicate that the signals come from pipeline register D, and `d_` for the result value, to indicate that it is generated in the decode stage. To avoid repetition, we will not show the HCL code here for blocks that only differ from those in SEQ because of the prefixes on names. As a reference, the complete HCL code for PIPE is given in Web Aside ARCH:HCL on page 472.

# PC Selection and Fetch Stage

Figure 4.57 provides a detailed view of the PIPE fetch stage logic. As discussed earlier, this stage must also select a current value for the program counter and predict the next PC value. The hardware units for reading the instruction from

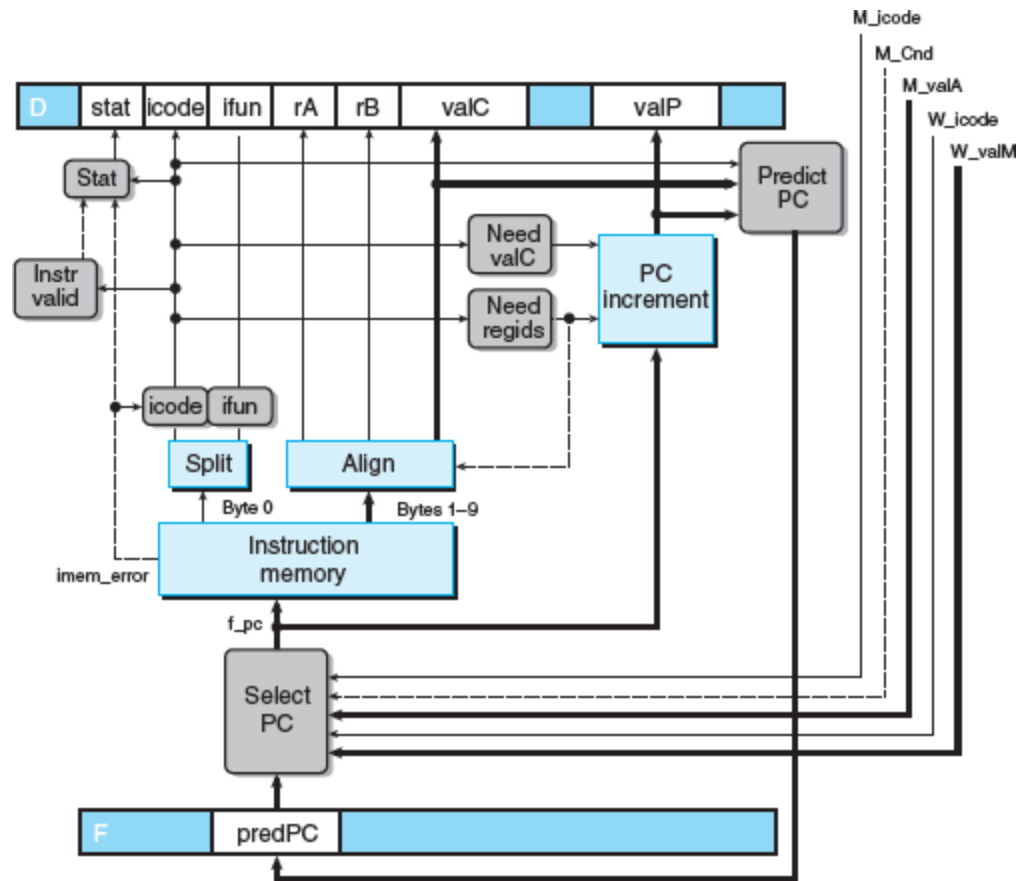


Figure 4.57 PIPE PC selection and fetch logic.

Within the one cycle time limit, the processor can only predict the address of the next instruction.

memory and for extracting the different instruction fields are the same as those we considered for SEQ (see the fetch stage in [Section 4.3.4](#)).

The PC selection logic chooses between three program counter sources. As a mispredicted branch enters the memory stage, the value of valP for this instruction (indicating the address of the following instruction) is read from pipeline register M (signal M\_valA). When a `ret` instruction enters the write-back stage, the return address is read from pipeline register W (signal W\_valM). All other cases use the predicted value of the PC, stored in pipeline register F (signal F\_predPC):

```
word f_pc = [  
    # Mispredicted branch. Fetch at incremented PC  
    M_icode == IJXX && !M_Cnd : M_valA;  
    # Completion of RET instruction  
    W_icode == IRET : W_valM;  
    # Default: Use predicted value of PC  
    1 : F_predPC;  
];
```

The PC prediction logic chooses valC for the fetched instruction when it is either a call or a jump, and valP otherwise:

```
word f_predPC = [  
    f_icode in { IJXX, ICALL } : f_valC;  
    1 : f_valP;  
];
```


The logic blocks labeled "Instr valid," "Need regids," and "Need valC" are the same as for SEQ, with appropriately named source signals.

Unlike in SEQ, we must split the computation of the instruction status into two parts. In the fetch stage, we can test for a memory error due to an out-of-range instruction address, and we can detect an illegal instruction or a halt instruction. Detecting an invalid data address must be deferred to the memory stage.

## Practice Problem 4.30 (solution page [490](#))

Write HCL code for the signal `f_stat`, providing the provisional status for the fetched instruction.

## *Decode and Write-Back Stages*

**Figure 4.58**  gives a detailed view of the decode and write-back logic for PIPE. The blocks labeled dstE, dstM, srcA, and srcB are very similar to their counterparts in the implementation of SEQ. Observe that the register IDs supplied to the write ports come from the write-back stage (signals W\_dstE and W\_dstM), rather than from the decode stage. This is because we want the writes to occur to the destination registers specified by the instruction in the write-back stage.

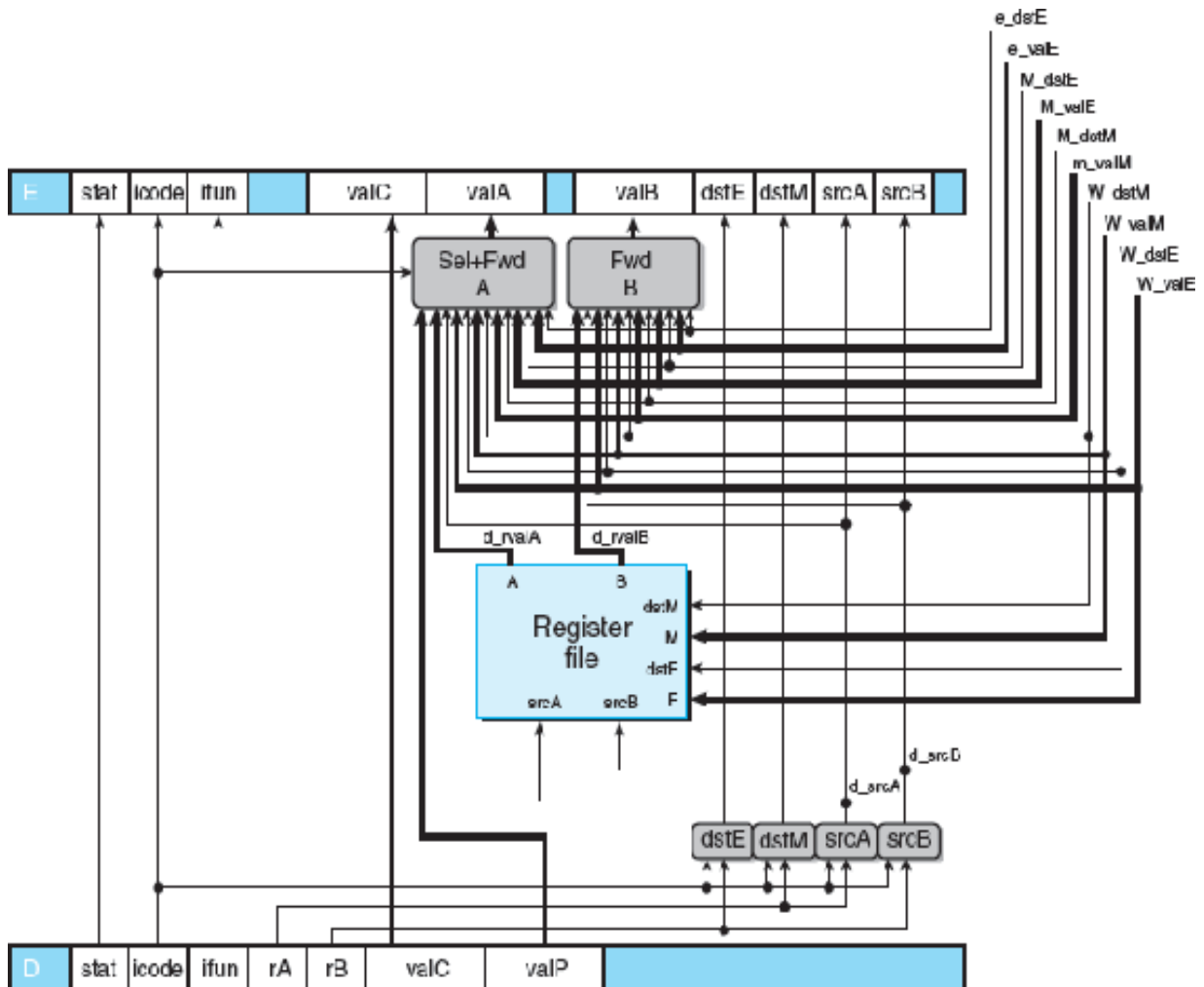
[OceanofPDF.com](http://OceanofPDF.com)

## Practice Problem 4.31 (solution page [490](#))

The block labeled "dstE" in the decode stage generates the register ID for the E port of the register file, based on fields from the fetched instruction in pipeline register D. The resulting signal is named `d_dstE` in the HCL description of PIPE. Write HCL code for this signal, based on the HCL description of the SEQ signal `dstE`. (See the decode stage for SEQ in [Section 4.3.4](#).) Do not concern yourself with the logic to implement conditional moves yet.

Most of the complexity of this stage is associated with the forwarding logic. As mentioned earlier, the block labeled "Sel+Fwd A" serves two roles. It merges the `valP` signal into the `valA` signal for later stages in order to reduce the amount of state in the pipeline register. It also implements the forwarding logic for source operand `valA`.

The merging of signals `valA` and `valP` exploits the fact that only the `call` and jump instructions need the value of `valP` in later stages, and these instructions



**Figure 4.58 PIPE decode and write-back stage logic.**

No instruction requires both valP and the value read from register port A, and so these two can be merged to form the signal valA for later stages. The block labeled "Sel+Fwd A" performs this task and also implements the forwarding logic for source operand valA. The block labeled "Fwd B" implements the forwarding logic for source operand valB. The register write locations are specified by the dstE and dstM signals from the write-back stage rather than from the decode stage, since it is writing the results of the instruction currently in the write-back stage.

do not need the value read from the A port of the register file. This selection is controlled by the icode signal for this stage. When signal `D_icode` matches the instruction code for either `call` or `jXX`, this block should select `D_valP` as its output.

As mentioned in [Section 4.5.5](#), there are five different forwarding sources, each with a data word and a destination register ID:

If none of the forwarding conditions hold, the block should select `d_rvalA`, the value read from register port A, as its output.

Putting all of this together, we get the following HCL description for the new value of `valA` for pipeline register E:



```

word d_valA = [
    D_icode in { ICALL, IJXX } : D_valP; # Use incremented
PC
    d_srcA == e_dstE : e_valE;      # Forward valE from
execute
    d_srcA == M_dstM : m_valM;      # Forward valM from
memory
    d_srcA == M_dstE : M_valE;      # Forward valE from
memory
    d_srcA == W_dstM : W_valM;      # Forward valM from
write back
    d_srcA == W_dstE : W_valE;      # Forward valE from
write back
    1 : d_rvalA; # Use value read from register file
];

```

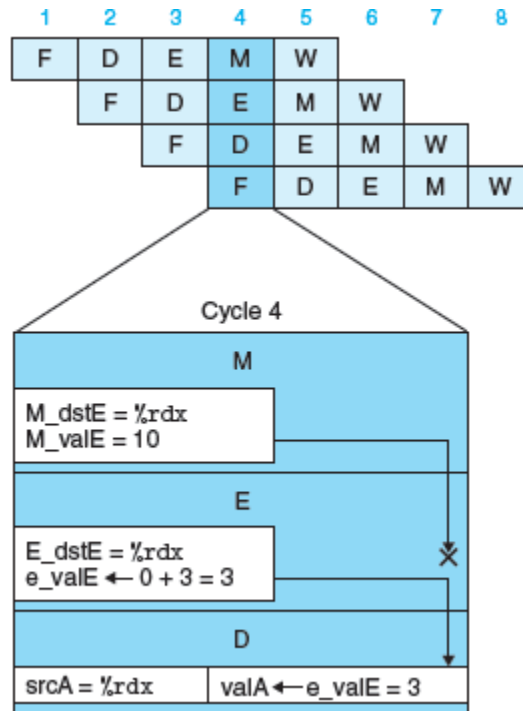
The priority given to the five forwarding sources in the above HCL code is very important. This priority is determined in the HCL code by the order in which the five destination register IDs are tested. If any order other than the one shown were chosen, the pipeline would behave incorrectly for some programs. Figure 4.59 shows an example of a program that requires a correct setting of priority among the forwarding sources in the execute and memory stages. In this program, the first two instructions write to register `%rdx`, while the third uses this register as its source operand. When the `rrmovq` instruction reaches the decode stage in cycle 4, the forwarding logic

must choose between two values destined for its source register. Which one should it choose? To set the priority, we must consider the behavior of the machine-language program when it is executed one instruction at a time. The first `irmovq` instruction would set register `%rdx` to 10, the second would set the register to 3, and then the `rrmovq` instruction would read 3 from `%rdx`. To imitate this behavior, our pipelined implementation should always give priority to the forwarding source in the earliest pipeline stage, since it holds the latest instruction in the program sequence setting the register. Thus, the logic in the HCL code above first tests the forwarding source in the execute stage, then those in the memory stage, and finally the sources in the write-back stage. The forwarding priority between the two sources in either the memory or the write-back stages is only a concern for the instruction `popq %rsp`, since only this instruction can attempt two simultaneous writes to the same register.

```

# prog8
0x000: irmovq $10,%rdx
0x00a: irmovq $3,%rdx
0x014: rrmovq %rdx,%rax
0x016: halt

```



**Figure 4.59 Demonstration of forwarding priority.**

In cycle 4, values for `%rdx` are available from both the execute and memory stages. The forwarding logic should choose the one in the execute stage, since it represents the most recently generated value for this register.

## Practice Problem 4.32 (solution page [490](#))

Suppose the order of the third and fourth cases (the two forwarding sources from the memory stage) in the HCL code for `d_valA` were reversed. Describe the resulting behavior of the `rrmovq` instruction (line 5) for the following program:

```
1  irmovq $5, %rdx
2  irmovq $0x100,%rsp
3  rmmovq %rdx,0(%rsp) popq%rsp
5  rrmovq %rsp,%rax
```

## Practice Problem 4.33 (solution page [491](#))

Suppose the order of the fifth and sixth cases (the two forwarding sources from the write-back stage) in the HCL code for `d_valA` were reversed. Write a Y86-64 program that would be executed incorrectly. Describe how the error would occur and its effect on the program behavior.

## Practice Problem 4.34 (solution page [491](#))

Write HCL code for the signal `d_valB`, giving the value for source operand `valB` supplied to pipeline register E.

One small part of the write-back stage remains. As shown in [Figure 4.52](#), the overall processor status `Stat` is computed by a block based on the status value in pipeline register `W`. Recall from [Section 4.1.1](#) that the code should indicate either normal operation (`AOK`) or one of the three exception conditions. Since pipeline register `W` holds the state of the most recently completed instruction, it is natural to use this value as an indication of the overall processor status. The only special case to consider is when there is a bubble in the write-back stage. This is part of normal operation, and so we want the status code to be `AOK` for this case as well:

```
word Stat = [  
    W_stat == SBUB : SAOK;  
    1 : W_stat;  
];
```

# Execute Stage

Figure 4.60 shows the execute stage logic for PIPE. The hardware units and the logic blocks are identical to those in SEQ, with an appropriate renaming of signals. We can see the signals `e_valE` and `e_dstE` directed toward the decode stage as one of the forwarding sources. One difference is that the logic labeled "Set CC," which determines whether or not to update the condition codes, has signals `m_stat` and `W_stat` as inputs. These signals are used to detect cases where an instruction

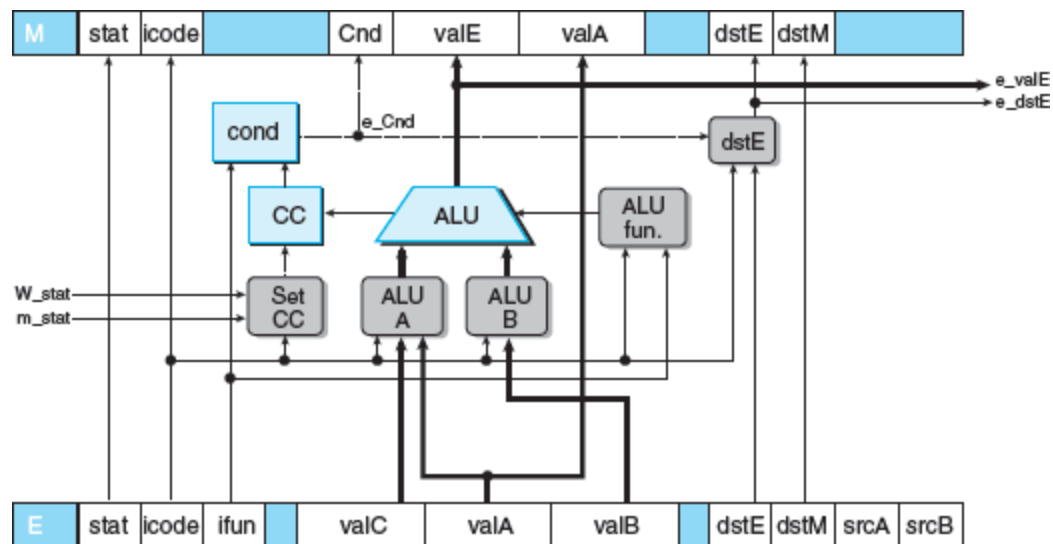
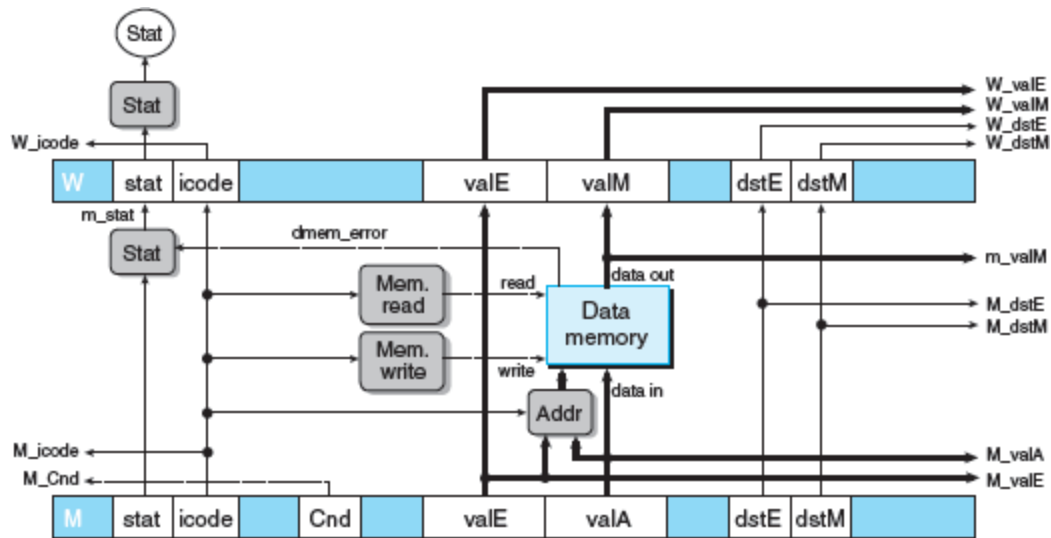


Figure 4.60 PIPE execute stage logic.

This part of the design is very similar to the logic in the SEQ implementation.



**Figure 4.61 PIPE memory stage logic.**



Many of the signals from pipeline registers M and W are passed down to earlier stages to provide write-back results, instruction addresses, and forwarded results.

causing an exception is passing through later pipeline stages, and therefore any updating of the condition codes should be suppressed. This aspect of the design is discussed in [Section 4.5.8](#).

## Practice Problem 4.35 (solution page 491)

Our second case in the HCL code for `d_valA` uses signal `e_dstE` to see whether to select the ALU output `e_valE` as the forwarding source. Suppose instead that we use signal `E_dstE`, the destination register ID in pipeline register E for this selection. Write a Y86-64 program that would give an incorrect result with this modified forwarding logic.

## Memory Stage

**Figure 4.61**  shows the memory stage logic for PIPE. Comparing this to the memory stage for SEQ (**Figure 4.30** ) , we see that, as noted before, the block labeled "Mem. data" in SEQ is not present in PIPE. This block served to select between data sources valP (for `call` instructions) and valA, but this selection is now performed by the block labeled "Sel+Fwd A" in the decode stage. Most other blocks in this stage are identical to their counterparts in SEQ, with an appropriate renaming of the signals. In this figure, you can also see that many of the values in pipeline registers and M and W are supplied to other parts of the circuit as part of the forwarding and pipeline control logic.

### Practice Problem 4.36 (solution page **492**)

In this stage, we can complete the computation of the status code Stat by detecting the case of an invalid address for the data memory. Write HCL code for the signal `m_stat`.



## 4.5.8 Pipeline Control Logic

We are now ready to complete our design for PIPE by creating the pipeline control logic. This logic must handle the following four control cases for which other mechanisms, such as data forwarding and branch prediction, do not suffice:

**Load/use hazards.** The pipeline must stall for one cycle between an instruction that reads a value from memory and an instruction that uses this value.

**Processing ret.** The pipeline must stall until the `ret` instruction reaches the write-back stage.

**Mispredicted branches.** By the time the branch logic detects that a jump should not have been taken, several instructions at the branch target will have started down the pipeline. These instructions must be canceled, and fetching should begin at the instruction following the jump instruction.

**Exceptions.** When an instruction causes an exception, we want to disable the updating of the programmer-visible state by later instructions and halt execution once the excepting instruction reaches the write-back stage.

We will go through the desired actions for each of these cases and then develop control logic to handle all of them.

## *Desired Handling of Special Control Cases*

For a load/use hazard, we have described the desired pipeline operation in [Section 4.5.5](#), as illustrated by the example of [Figure 4.54](#). Only the `mrmovq` and `popq` instructions read data from memory. When (1) either of these is in the execute stage and (2) an instruction requiring the destination register is in the decode stage, we want to hold back the second instruction in the decode stage and inject a bubble into the execute stage on the next cycle. After this, the forwarding logic will resolve the data hazard. The pipeline can hold back an instruction in the decode stage by keeping pipeline register D in a fixed state. In doing so, it should also keep pipeline register F in a fixed state, so that the next instruction will be fetched a second time. In summary, implementing this pipeline flow requires detecting the hazard condition, keeping pipeline registers F and D fixed, and injecting a bubble into the execute stage.

For the processing of a `ret` instruction, we have described the desired pipeline operation in [Section 4.5.5](#). The pipeline should stall for three cycles until the return address is read as the `ret` instruction passes through the memory stage.

This was illustrated by a simplified pipeline diagram in [Figure 4.55](#) for processing the following program:

```

0x000:  irmovq stack,%rsp          # Initialize stack
pointer
0x00a:  call proc                   # Procedure call
0x013:  irmovq $10,%rdx           # Return point
0x01d:  halt
0x020:  .pos 0x20
0x020:  proc:                       # proc:
0x020 :  ret                         # Return immediately
0x021:  rrmovq %rdx,%rbx          # Not executed
0x030:  .pos 0x30
0x030:  stack:                      # stack: Stack pointer

```

**Figure 4.62** provides a detailed view of the processing of the `ret` instruction for the example program. The key observation here is that there is no way to inject a bubble into the fetch stage of our pipeline. On every cycle, the fetch stage reads *some* instruction from the instruction memory. Looking at the HCL code for implementing the PC prediction logic in **Section 4.5.7**, we can see that for the `ret` instruction, the new value of the PC is predicted to be `valP`, the address of the following instruction. In our example program, this would be `0x021`, the address of the `rrmovq` instruction following the `ret`. This prediction is not correct for this example, nor would it be for most cases, but we are not attempting to predict return addresses correctly in our design. For three clock cycles, the fetch stage stalls, causing the `rrmovq` instruction to be fetched but then replaced by a bubble in the decode stage. This process is illustrated in **Figure**

4.62 by the three fetches, with an arrow leading down to the bubbles passing through the remaining pipeline stages. Finally, the `irmovq` instruction is fetched on cycle 7. Comparing Figure 4.62 with

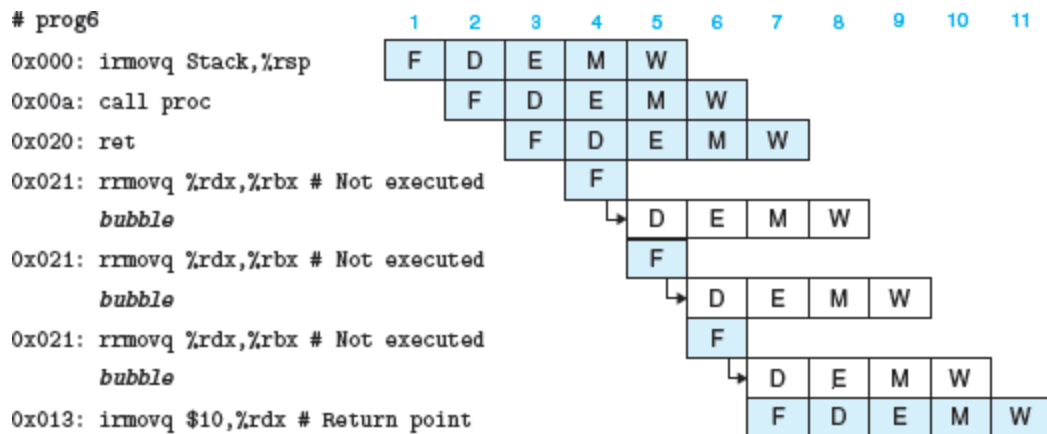


Figure 4.62 Detailed processing of the `ret` instruction.

The fetch stage repeatedly fetches the `rrmovq` instruction following the `ret` instruction, but then the pipeline control logic injects a bubble into the decode stage rather than allowing the `rrmovq` instruction to proceed. The resulting behavior is equivalent to that shown in Figure 4.55.

Figure 4.55, we see that our implementation achieves the desired effect, but with a slightly peculiar fetching of an incorrect instruction for three consecutive cycles.

When a mispredicted branch occurs, we have described the desired pipeline operation in Section 4.5.5 and illustrated it in Figure 4.56. The misprediction will be detected as the jump instruction

reaches the execute stage. The control logic then injects bubbles into the decode and execute stages on the next cycle, causing the two incorrectly fetched instructions to be canceled. On the same cycle, the pipeline reads the correct instruction into the fetch stage.

For an instruction that causes an exception, we must make the pipelined implementation match the desired ISA behavior, with all prior instructions completing and with none of the following instructions having any effect on the program state. Achieving these effects is complicated by the facts that (1) exceptions are detected during two different stages (fetch and memory) of program execution, and (2) the program state is updated in three different stages (execute, memory, and write-back).

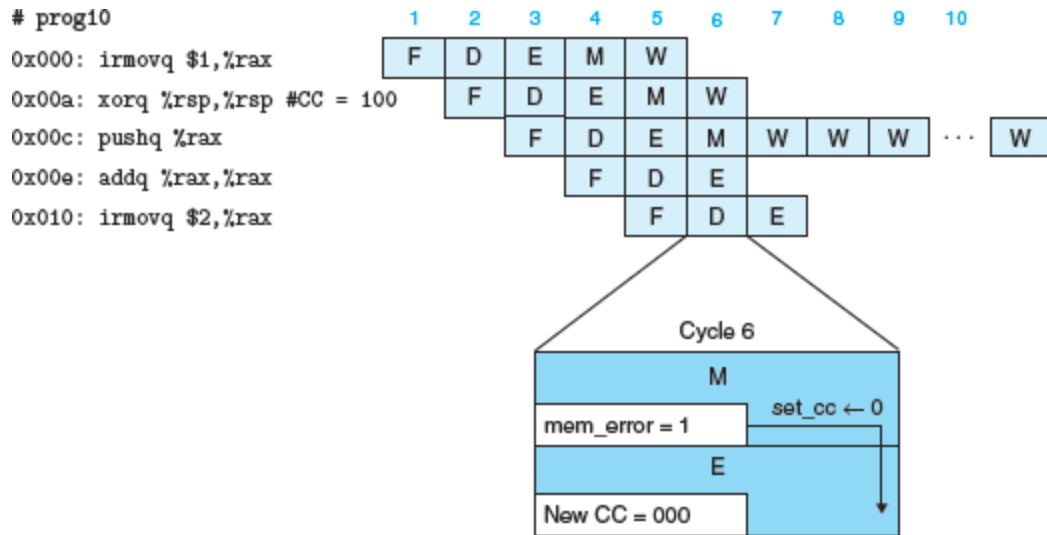
Our stage designs include a status code stat in each pipeline register to track the status of each instruction as it passes through the pipeline stages. When an exception occurs, we record that information as part of the instruction's status and continue fetching, decoding, and executing instructions as if nothing were amiss. As the excepting instruction reaches the memory stage, we take steps to prevent later instructions from modifying the programmer-visible state by (1) disabling the setting of condition codes by instructions in the execute stage, (2) injecting bubbles into the memory stage to disable any writing to the data memory, and (3) stalling the write-back stage when it has an excepting instruction, thus bringing the pipeline to a halt.

The pipeline diagram in [Figure 4.63](#) illustrates how our pipeline control handles the situation where an instruction causing an exception is followed by one that would change the condition codes. On cycle 6, the `pushq` instruction reaches the memory stage and generates a memory error. On the same cycle, the `addq` instruction in the execute stage generates new values for the condition codes. We disable the setting of condition codes when an excepting instruction is in the memory or write-back stage (by examining the signals `m_stat` and `W_stat` and then setting the signal `set_cc` to zero). We can also see the combination of injecting bubbles into the memory stage and stalling the excepting instruction in the write-back stage in the example of [Figure 4.63](#)—the `pushq` instruction remains stalled in the write-back stage, and none of the subsequent instructions get past the execute stage.

By this combination of pipelining the status signals, controlling the setting of condition codes, and controlling the pipeline stages, we achieve the desired behavior for exceptions: all instructions prior to the excepting instruction are completed, while none of the following instructions has any effect on the programmer-visible state.

# Detecting Special Control Conditions

Figure 4.64 summarizes the conditions requiring special pipeline control. It gives expressions describing the conditions under which the three special cases arise.



**Figure 4.63 Processing invalid memory reference exception.** On cycle 6, the invalid memory reference by the `pushq` instruction causes the updating of the condition codes to be disabled. The pipeline starts injecting bubbles into the memory stage and stalling the excepting instruction in the write-back stage.

### Figure 4.64 Detection conditions for pipeline control logic.


Four different conditions require altering the pipeline flow by either stalling the pipeline or canceling partially executed instructions.

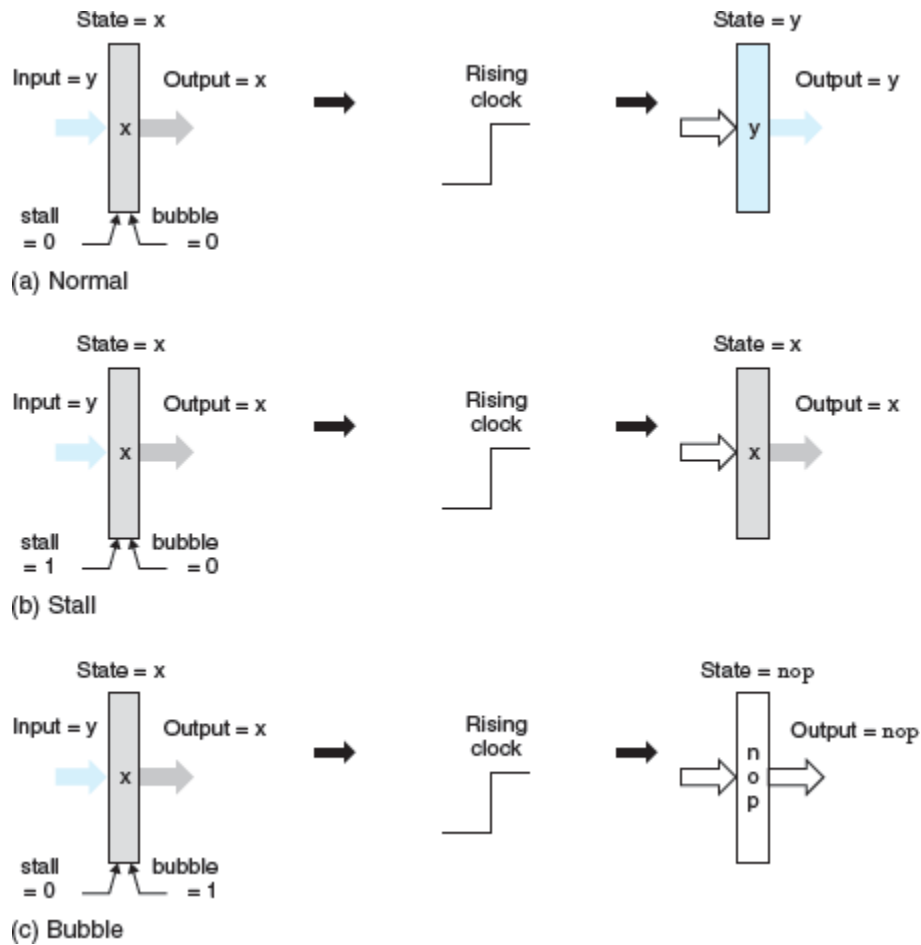
These expressions are implemented by simple blocks of combinational logic that must generate their results before the end of the clock cycle in order to control the action of the pipeline registers as the clock rises to start the next cycle. During a clock cycle, pipeline registers D, E, and M hold the states of the instructions that are in the decode, execute, and memory pipeline stages, respectively. As we approach the end of the clock cycle, signals `d_srcA` and `d_srcB` will be set to the register IDs of the source operands for the instruction in the decode stage. Detecting a `ret` instruction as it passes through the pipeline simply involves checking the instruction codes of the instructions in the decode, execute, and memory stages. Detecting a load/use hazard involves checking the instruction type (`mrmovq` or `popq`) of the instruction in the execute stage and comparing its destination register with the source registers of the instruction in the decode stage. The pipeline control logic should detect a mispredicted branch while the jump instruction is in the execute stage, so that it can set up the conditions required to recover from the misprediction as the instruction enters the memory stage. When a jump instruction is in the execute stage, the signal `e_Cnd` indicates whether or not the jump should be taken. We detect an excepting instruction by examining the instruction status values in the memory and write-back stages. For the memory stage, we use the signal `m_stat`, computed within the stage, rather than `M_stat`



from the pipeline register. This internal signal incorporates the possibility of a data memory address error.

## *Pipeline Control Mechanisms*

**Figure 4.65**  shows low-level mechanisms that allow the pipeline control logic to hold back an instruction in a pipeline register or to inject a bubble into the pipeline. These mechanisms involve small extensions to the basic clocked register described



**Figure 4.65 Additional pipeline register operations,**

(a) Under normal conditions, the state and output of the register are set to the value at the input when the clock rises, (b) When operated in *stall* mode, the state is held fixed at its previous value, (c) When operated in *bubble* mode, the state is overwritten with that of a `nop` operation.

### Figure 4.66 Actions for pipeline control logic.

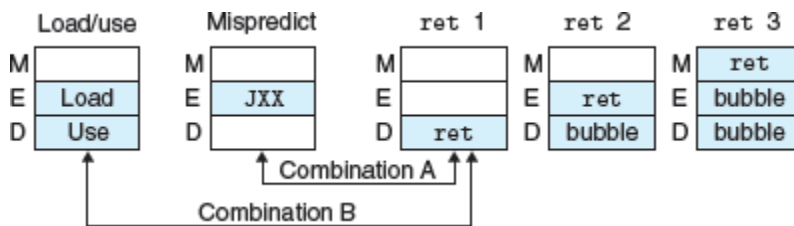
The different conditions require altering the pipeline flow by either stalling the pipeline or canceling partially executed instructions.

in [Section 4.2.5](#). Suppose that each pipeline register has two control inputs `stall` and `bubble`. The settings of these signals determine how the pipeline register is updated as the clock rises. Under normal operation ([Figure 4.65\(a\)](#)), both of these inputs are set to 0, causing the register to load its input as its new state. When the `stall` signal is set to 1 ([Figure 4.65\(b\)](#)), the updating of the state is disabled. Instead, the register will remain in its previous state. This makes it possible to hold back an instruction in some pipeline stage. When the `bubble` signal is set to 1 ([Figure 4.65\(c\)](#)), the state of the register will be set to some fixed *reset configuration*, giving a state equivalent to that of a `nop` instruction. The particular pattern of ones and zeros for a pipeline register's reset configuration depends on the set of fields in the pipeline register. For example, to inject a bubble into pipeline register D, we want the `icode` field to be set to the constant value `INOP` ([Figure 4.26](#)). To inject a bubble into pipeline register E, we want the `icode` field to be set to `INOP` and the `dstE`, `dstM`, `srcA`, and `srcB` fields to be set to the constant `RNONE`. Determining the reset configuration is one of the tasks for the hardware designer in designing a pipeline register. We will not concern ourselves with the details here. We will consider it an error to set both the `bubble` and the `stall` signals to 1.

The table in [Figure 4.66](#) shows the actions the different pipeline stages should take for each of the three special conditions. Each involves some combination of normal, stall, and bubble operations for the pipeline registers. In terms of timing, the stall and bubble control signals for the pipeline registers are generated by blocks of combinational logic. These values must be valid as the clock rises, causing each of the pipeline registers to either load, stall, or bubble as the next clock cycle begins. With this small extension to the pipeline register designs, we can implement a complete pipeline, including all of its control, using the basic building blocks of combinational logic, clocked registers, and random access memories.

## Combinations of Control Conditions

In our discussion of the special pipeline control conditions so far, we assumed that at most one special case could arise during any single clock cycle. A common bug in designing a system is to fail to handle instances where multiple special conditions arise simultaneously. Let us analyze such possibilities. We need not worry about combinations involving program exceptions, since we have carefully designed our exception-handling mechanism to consider other instructions in the pipeline. **Figure 4.67** diagrams the pipeline states that cause the other three special control



**Figure 4.67** Pipeline states for special control conditions.

The two pairs indicated can arise simultaneously.

conditions. These diagrams show blocks for the decode, execute, and memory stages. The shaded boxes represent particular constraints that must be satisfied for the condition to arise. A load/use hazard requires that the instruction in the execute stage reads a value from memory into a register, and that the instruction in the decode stage has this register as a source operand. A mispredicted branch requires the instruction in the execute stage to have a jump instruction. There are three possible cases for `ret`—the


instruction can be in either the decode, execute, or memory stage. As the `ret` instruction moves through the pipeline, the earlier pipeline stages will have bubbles.

We can see by these diagrams that most of the control conditions are mutually exclusive. For example, it is not possible to have a load/use hazard and a mispredicted branch simultaneously, since one requires a load instruction (`mrmovq` or `popq`) in the execute stage, while the other requires a jump. Similarly, the second and third `ret` combinations cannot occur at the same time as a load/use hazard or a mispredicted branch. Only the two combinations indicated by arrows can arise simultaneously.

Combination A involves a not-taken jump instruction in the execute stage and a `ret` instruction in the decode stage. Setting up this combination requires the `ret` to be at the target of a not-taken branch. The pipeline control logic should detect that the branch was mispredicted and therefore cancel the `ret` instruction.

## Practice Problem 4.37 (solution page [492](#))

Write a Y86-64 assembly-language program that causes combination A to arise and determines whether the control logic handles it correctly.

Combining the control actions for the combination A conditions ([Figure 4.66](#) ) , we get the following pipeline control actions


(assuming that either a bubble or a stall overrides the normal case):

That is, it would be handled like a mispredicted branch, but with a stall in the fetch stage. Fortunately, on the next cycle, the PC selection logic will choose the address of the instruction following the jump, rather than the predicted program counter, and so it does not matter what happens with the pipeline register F. We conclude that the pipeline will correctly handle this combination.

Combination B involves a load/use hazard, where the loading instruction sets register `%rsp` and the `ret` instruction then uses this register as a source operand, since it must pop the return address from the stack. The pipeline control logic should hold back the `ret` instruction in the decode stage.

## Practice Problem 4.38 (solution page [492](#))

Write a Y86-64 assembly-language program that causes combination B to arise and completes with a halt instruction if the pipeline operates correctly.

Combining the control actions for the combination B conditions ([Figure 4.66](#) ) , we get the following pipeline control actions:



If both sets of actions were triggered, the control logic would try to stall the `ret` instruction to avoid the load/use hazard but also inject a bubble into the decode stage due to the `ret` instruction. Clearly, we do not want the pipeline to perform both sets of actions. Instead, we want it to just take the actions for the load/use hazard. The actions for processing the `ret` instruction should be delayed for one cycle.

This analysis shows that combination B requires special handling. In fact, our original implementation of the PIPE control logic did not handle this combination correctly. Even though the design had passed many simulation tests, it had a subtle bug that was uncovered only by the analysis we have just shown. When a program having combination B was executed, the control logic would set both the bubble and the stall signals for pipeline register D to 1. This example shows the importance of systematic analysis. It would be unlikely to uncover this bug by just running normal programs. If left undetected, the pipeline would not faithfully implement the ISA behavior.

# Control Logic Implementation

Figure 4.68 shows the overall structure of the pipeline control logic. Based on signals from the pipeline registers and pipeline stages, the control logic generates

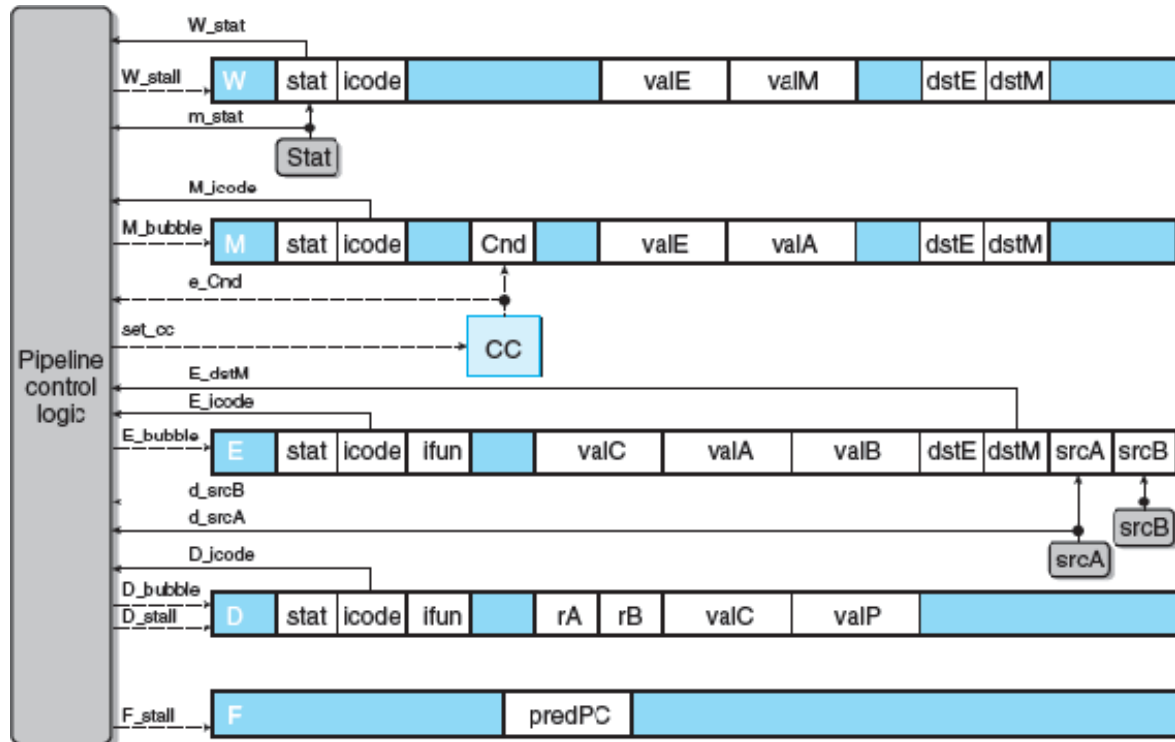


Figure 4.68 PIPE pipeline control logic.

This logic overrides the normal flow of instructions through the pipeline to handle special conditions such as procedure returns, mispredicted branches, load/use hazards, and program exceptions.

stall and bubble control signals for the pipeline registers and also determines whether the condition code registers should be updated. We can combine the detection conditions of Figure 4.64 with the

actions of [Figure 4.66](#) to create HCL descriptions for the different pipeline control signals.

Pipeline register F must be stalled for either a load/use hazard or a `ret` instruction:

```
bool F_stall =  
    # Conditions for a load/use hazard  
    E_icode in { IMRMOVQ, IPOPQ } &&  
    E_dstM in { d_srcA, d_srcB } | |  
    # Stalling at fetch while ret passes through pipeline  
    IRET in { D_icode, E_icode, M_icode };
```

## Practice Problem 4.39 (solution page [493](#))

Write HCL code for the signal `D_stall` in the PIPE implementation.

Pipeline register D must be set to bubble for a mispredicted branch or a `ret` instruction. As the analysis in the preceding section shows, however, it should not inject a bubble when there is a load/use hazard in combination with a `ret` instruction:

```
bool D_bubble =
    # Mispredicted branch (E_icode == IJXX && !e_Cnd) ||
    # Stalling at fetch while ret passes through pipeline
    # but not condition for a load/use hazard
    !(E_icode in { IMRMOVQ, IPOPOP } && E_dstM in { d_srcA,
d_srcB }) && IRET in { D_icode, E_icode, M_icode };
```


## Practice Problem 4.40 (solution page [493](#))

Write HCL code for the signal `E_bubble` in the PIPE implementation.

## Practice Problem 4.41 (solution page [493](#))

Write HCL code for the signal `set_cc` in the PIPE implementation. This should only occur for `OPq` instructions, and should consider the effects of program exceptions.

## Practice Problem 4.42 (solution page [493](#))

Write HCL code for the signals `M_bubble` and `W_stall` in the PIPE implementation. The latter signal requires modifying the exception condition listed in [Figure 4.64](#) .

This covers all of the special pipeline control signal values. In the complete HCL code for PIPE, all other pipeline control signals are set to zero.

## 4.5.9 Performance Analysis

We can see that the conditions requiring special action by the pipeline control logic all cause our pipeline to fall short of the goal of issuing a new instruction on every clock cycle. We can measure this inefficiency by determining how often a bubble gets injected into the pipeline, since these cause unused pipeline cycles. A return instruction generates three bubbles, a load/use hazard generates one, and a mispredicted branch generates two. We can quantify the effect these penalties have on the overall performance by computing an estimate of the average number of clock cycles PIPE would require per instruction it executes, a measure known as the CPI (for "cycles per instruction"). This measure is the reciprocal of the average throughput of the pipeline, but with time measured in clock cycles rather than picoseconds. It is a useful measure of the architectural efficiency of a design.

If we ignore the performance implications of exceptions (which, by definition, will only occur rarely), another way to think about CPI is to imagine we run the

## Aside Testing the design

As we have seen, there are many ways to introduce bugs into a design, even for a simple microprocessor. With pipelining, there are many subtle interactions between the instructions at different pipeline stages. We have seen that many of the design challenges involve unusual instructions (such as popping to the stack pointer) or unusual instruction combinations (such as a not-taken jump followed by a `ret`). We also see that exception handling adds an entirely new dimension to the possible pipeline behaviors. How, then, can we be sure that our design is correct? For hardware manufacturers, this is a dominant concern, since they cannot simply report an error and have users download code patches over the Internet. Even a simple logic design error can have serious consequences, especially as microprocessors are increasingly used to operate systems that are critical to our lives and health, such as automotive antilock braking systems, heart pacemakers, and aircraft control systems.

Simply simulating a design while running a number of "typical" programs is not a sufficient means of testing a system. Instead, thorough testing requires devising ways of systematically generating many tests that will exercise as many different instructions and instruction combinations as possible. In creating our Y86-64 processor designs, we also devised a number of testing scripts, each of which generates many different tests, runs simulations of the processor, and compares the resulting register and memory values to those


produced by our `YIS` instruction set simulator. Here is a brief description of the scripts:

**optest.** Runs 49 tests of different Y86-64 instructions with different source and destination registers

**jtest.** Runs 64 tests of the different jump and call instructions, with different combinations of whether or not the branches are taken

**erntest.** Runs 28 tests of the different conditional move instructions, with different control combinations

**htest.** Runs 600 tests of different data hazard possibilities, with different combinations of source and destination instructions, and with different numbers of `nop` instructions between the instruction pairs

**ctest.** Tests 22 different control combinations, based on an analysis similar to what we did in [Section 4.5.8](#) 

**etest.** Tests 12 different combinations where an instruction causes an exception and the instructions following it could alter the programmer-visible state

The key idea of this testing method is that we want to be as systematic as possible, generating tests that create the different conditions that are likely to cause pipeline errors.

processor on some benchmark program and observe the operation of the execute stage. On each cycle, the execute stage either (1) processes an instruction and this instruction continues through the

remaining stages to completion, or (2) processes a bubble injected due to one of the three special cases. If the stage processes a total of  $C_i$  instructions and  $C_b$  bubbles, then the processor has required around  $C_i + C_b$  total clock cycles to execute  $C_i$  instructions. We say "around" because we ignore



## Aside Formally verifying our design

Even when a design passes an extensive set of tests, we cannot be certain that it will operate correctly for all possible programs. The number of possible programs we could test is unimaginably large, even if we only consider tests consisting of short code segments. Newer methods of *formal verification*, however, hold the promise that we can have tools that rigorously consider all possible behaviors of a system and determine whether or not there are any design errors.

We were able to apply formal verification to an earlier version of our Y86-64 processors [13]. We set up a framework to compare the behavior of the pipelined design PIPE to the unpipelined version SEQ. That is, it was able to prove that for an arbitrary machine-language program, the two processors would have identical effects on the programmer-visible state. Of course, our verifier cannot actually run all possible programs, since there are an infinite number of them. Instead, it uses a form of proof by induction, showing a consistency between the two processors on a cycle-by-cycle basis. Carrying out this analysis requires reasoning about the hardware using *symbolic methods* in which we consider all program values to be arbitrary integers, and we abstract the ALU as a sort of "black box," computing some unspecified function over its arguments. We assume only that the ALUs for SEQ and PIPE compute identical functions.

We used the HCL descriptions of the control logic to generate the control logic for our symbolic processor models, and so we could catch any bugs in the HCL code. Being able to show that SEQ and PIPE are identical does not guarantee that either of them faithfully implements the instruction set architecture. However, it would uncover any bug due to an incorrect pipeline design, and this is the major source of design errors.

In our experiments, we verified not only a version of PIPE similar to the one we have presented in this chapter but also several variants that we give as homework problems, in which we add more instructions, modify the hardware capabilities, or use different branch prediction strategies. Interestingly, we found only one bug in all of our designs, involving control combination B (described in [Section 4.5.8](#)) for our solution to the variant described in [Problem 4.58](#). This exposed a weakness in our testing regime that caused us to add additional cases to the ctest testing script.

Formal verification is still in an early stage of development. The tools are often difficult to use, and they do not have the capacity to verify large-scale designs. We were able to verify our processors in part because of their relative simplicity. Even then, it required several weeks of effort and multiple runs of the tools, each requiring up to 8 hours of computer time. This is an active area of research, with some tools becoming commercially available and some in use at companies such as Intel, AMD, and IBM.

the cycles required to start the instructions flowing through the pipeline. We can then compute the CPI for this benchmark as follows:

$$\text{CPI} = \frac{C_i + C_b}{C_i} = 1.0 + \frac{C_b}{C_i}$$

That is, the CPI equals 1.0 plus a penalty term  $C_b/C_i$  indicating the average number of bubbles injected per instruction executed. Since only three different instruction types can cause a bubble to be injected, we can break this penalty term into three components:

# Web Aside ARCH:VLOG Verilog implementation of a pipelined Y86- 64 processor

As we have mentioned, modern logic design involves writing textual representations of hardware designs in a *hardware description language*. The design can then be tested by both simulation and a variety of formal verification tools. Once we have confidence in the design, we can use *logic synthesis* tools to translate the design into actual logic circuits.

We have developed models of our Y86-64 processor designs in the Verilog hardware description language. These designs combine modules implementing the basic building blocks of the processor, along with control logic generated directly from the HCL descriptions. We have been able to synthesize some of these designs, download the logic circuit descriptions onto field-programmable gate array (FPGA) hardware, and run the processors on actual programs.

$$CPI=1.0+lp+mp+rp$$

where  $lp$  (for "load penalty") is the average frequency with which bubbles are injected while stalling for load/use hazards,  $mp$  (for "mispredicted branch penalty") is the average frequency with which bubbles are injected when canceling instructions due to mispredicted branches, and  $rp$  (for "return penalty") is the average frequency with

which bubbles are injected while stalling for `ret` instructions. Each of these penalties indicates the total number of bubbles injected for the stated reason (some portion of  $C_b$ ) divided by the total number of instructions that were executed ( $C_i$ )

To estimate each of these penalties, we need to know how frequently the relevant instructions (load, conditional branch, and return) occur, and for each of these how frequently the particular condition arises. Let us pick the following set of frequencies for our CPI computation (these are comparable to measurements reported in [44] and [46]):

- Load instructions (`mrmovq` and `popq`) account for 25% of all instructions executed. Of these, 20% cause load/use hazards.
- Conditional branches account for 20% of all instructions executed. Of these, 60% are taken and 40% are not taken.
- Return instructions account for 2% of all instructions executed.

We can therefore estimate each of our penalties as the product of the frequency of the instruction type, the frequency the condition arises, and the number of bubbles that get injected when the condition occurs:

The sum of the three penalties is 0.27, giving a CPI of 1.27.

Our goal was to design a pipeline that can issue one instruction per cycle, giving a CPI of 1.0. We did not quite meet this goal, but the overall performance is still quite good. We can also see that any effort to reduce the CPI further should focus on mispredicted branches. They account for 0.16 of our total penalty of 0.27, because conditional branches are common, our prediction strategy often fails, and we cancel two instructions for every misprediction.

## *Practice Problem 4.43 (solution page 494)*

Suppose we use a branch prediction strategy that achieves a success rate of 65%, such as backward taken, forward not taken (BTFNT), as described in [Section 4.5.4](#). What would be the impact on CPI, assuming all of the other frequencies are not affected?

## *Practice Problem 4.44 (solution page 494)*

Let us analyze the relative performance of using conditional data transfers versus conditional control transfers for the programs you wrote for Problems 4.5 and 4.6. Assume that we are using these programs to compute the sum of the absolute values of a very long array, and so the overall performance is determined largely by the number of cycles required by the inner loop. Assume that our jump instructions are predicted as being taken, and that around 50% of the array values are positive.

- A. On average, how many instructions are executed in the inner loops of the two programs?
- B. On average, how many bubbles would be injected into the inner loops of the two programs?
- C. What is the average number of clock cycles required per array element for the two programs?

## 4.5.10 Unfinished Business

We have created a structure for the PIPE pipelined microprocessor, designed the control logic blocks, and implemented pipeline control logic to handle special cases where normal pipeline flow does not suffice. Still, PIPE lacks several key features that would be required in an actual microprocessor design. We highlight a few of these and discuss what would be required to add them.



## *Multicycle Instructions*

All of the instructions in the Y86-64 instruction set involve simple operations such as adding numbers. These can be processed in a single clock cycle within the execute stage. In a more complete instruction set, we would also need to implement instructions requiring more complex operations such as integer multiplication and division and floating-point operations. In a medium-performance processor such as PIPE, typical execution times for these operations range from 3 or 4 cycles for floating-point addition up to 64 cycles for integer division. To implement these instructions, we require both additional hardware to perform the computations and a mechanism to coordinate the processing of these instructions with the rest of the pipeline.

One simple approach to implementing multicycle instructions is to simply expand the capabilities of the execute stage logic with integer and floating-point arithmetic units. An instruction remains in the execute stage for as many clock cycles as it requires, causing the fetch and decode stages to stall. This approach is simple to implement, but the resulting performance is not very good.

Better performance can be achieved by handling the more complex operations with special hardware functional units that operate independently of the main pipeline. Typically, there is one functional unit for performing integer multiplication and division, and another for performing floating-point operations. As an instruction enters the decode stage, it can be *issued* to the special unit. While the unit

performs the operation, the pipeline continues processing other instructions. Typically, the floating-point unit is itself pipelined, and thus multiple operations can execute concurrently in the main pipeline and in the different units.

The operations of the different units must be synchronized to avoid incorrect behavior. For example, if there are data dependencies between the different operations being handled by different units, the control logic may need to stall one part of the system until the results from an operation handled by some other part of the system have been completed. Often, different forms of forwarding are used to convey results from one part of the system to other parts, just as we saw between the different stages of PIPE. The overall design becomes more complex than we have seen with PIPE, but the same techniques of stalling, forwarding, and pipeline control can be used to make the overall behavior match the sequential ISA model.

## *Interfacing with the Memory System*

In our presentation of PIPE, we assumed that both the instruction fetch unit and the data memory could read or write any memory location in one clock cycle. We also ignored the possible hazards caused by self-modifying code where one instruction writes to the region of memory from which later instructions are fetched. Furthermore, we reference memory locations according to their virtual addresses, and these require a translation into physical addresses before the actual read or write operation can be performed. Clearly, it is unrealistic to do all of this processing in a single clock cycle. Even worse, the memory values being accessed may reside on disk, requiring millions of clock cycles to read into the processor memory.

As will be discussed in [Chapters 6](#) and [9](#), the memory system of a processor uses a combination of multiple hardware memories and operating system software to manage the virtual memory system. The memory system is organized as a hierarchy, with faster but smaller memories holding a subset of the memory being backed up by slower and larger memories. At the level closest to the processor, the *cache* memories provide fast access to the most heavily referenced memory locations. A typical processor has two first-level caches—one for reading instructions and one for reading and writing data. Another type of cache memory, known as a *translation look-aside buffer*, or TLB, provides a fast translation from virtual to physical addresses. Using a combination of TLBs and caches, it is indeed possible to read instructions and read or write

data in a single clock cycle most of the time. Thus, our simplified view of memory referencing by our processors is actually quite reasonable.

Although the caches hold the most heavily referenced memory locations, there will be times when a cache *miss* occurs, where some reference is made to a location that is not held in the cache. In the best case, the missing data can be retrieved from a higher-level cache or from the main memory of the processor, requiring 3 to 20 clock cycles. Meanwhile, the pipeline simply stalls, holding the instruction in the fetch or memory stage until the cache can perform the read or write operation. In terms of our pipeline design, this can be implemented by adding more stall conditions to the pipeline control logic. A cache miss and the consequent synchronization with the pipeline is handled completely by hardware, keeping the time required down to a small number of clock cycles.

In some cases, the memory location being referenced is actually stored in the disk or nonvolatile memory. When this occurs, the hardware signals a *page fault* exception. Like other exceptions, this will cause the processor to invoke the operating system's exception handler code. This code will then set up a transfer from the disk to the main memory. Once this completes, the operating system will return to the original program, where the instruction causing the page fault will be re-executed. This time, the memory reference will succeed, although it might cause a cache miss. Having the hardware invoke an operating system routine, which then returns control back to the hardware, allows the hardware and system software to

cooperate in the handling of page faults. Since accessing a disk can require millions of clock cycles, the several thousand cycles of processing performed by the OS page fault handler has little impact on performance.

From the perspective of the processor, the combination of stalling to handle short-duration cache misses and exception handling to handle long-duration page faults takes care of any unpredictability in memory access times due to the structure of the memory hierarchy.

[OceanofPDF.com](http://OceanofPDF.com)

## 4.6 Summary

We have seen that the instruction set architecture, or ISA, provides a layer of abstraction between the behavior of a processor—in terms of the set of instructions and their encodings—and how the processor is implemented. The ISA provides a very sequential view of program execution, with one instruction executed to completion before the next one begins.

# Aside State-of-the-art microprocessor design

A five-stage pipeline, such as we have shown with the PIPE processor, represented the state of the art in processor design in the mid-1980s. The prototype RISC processor developed by Patterson's research group at Berkeley formed the basis for the first SPARC processor, developed by Sun Microsystems in 1987. The processor developed by Hennessy's research group at Stanford was commercialized by MIPS Technologies (a company founded by Hennessy) in 1986. Both of these used five-stage pipelines. The Intel i486 processor also uses a five-stage pipeline, although with a different partitioning of responsibilities among the stages, with two decode stages and a combined execute/memory stage [27].

These pipelined designs are limited to a throughput of at most one instruction per clock cycle. The CPI (for "cycles per instruction") measure described in [Section 4.5.9](#) can never be less than 1.0. The different stages can only process one instruction at a time. More recent processors support *superscalar* operation, meaning that they can achieve a CPI less than 1.0 by fetching, decoding, and executing multiple instructions in parallel. As superscalar processors have become widespread, the accepted performance measure has shifted from CPI to its reciprocal—the average number of instructions executed per cycle, or IPC. It can exceed 1.0 for

superscalar processors. The most advanced designs use a technique known as *out-of-order* execution to execute multiple instructions in parallel, possibly in a totally different order than they occur in the program, while preserving the overall behavior implied by the sequential ISA model. This form of execution is described in [Chapter 5](#) as part of our discussion of program optimization.

Pipelined processors are not just historical artifacts, however. The majority of processors sold are used in embedded systems, controlling automotive functions, consumer products, and other devices where the processor is not directly visible to the system user. In these applications, the simplicity of a pipelined processor, such as the one we have explored in this chapter, reduces its cost and power requirements compared to higher-performance models.

More recently, as multicore processors have gained a following, some have argued that we could get more overall computing power by integrating many simple processors on a single chip rather than a smaller number of more complex ones. This strategy is sometimes referred to as "many-core" processors [\[10\]](#).

We defined the Y86-64 instruction set by starting with the x86-64 instructions and simplifying the data types, address modes, and instruction encoding considerably. The resulting ISA has attributes of both RISC and CISC instruction sets. We then organized the processing required for the different instructions into a series of five stages, where the operations at each stage vary according to the



instruction being executed. From this, we constructed the SEQ processor, in which an entire instruction is executed every clock cycle by having it flow through all five stages.

Pipelining improves the throughput performance of a system by letting the different stages operate concurrently. At any given time, multiple operations are being processed by the different stages. In introducing this concurrency, we must be careful to provide the same program-level behavior as would a sequential execution of the program. We introduced pipelining by reordering parts of SEQ to get SEQ+ and then adding pipeline registers to create the PIPE—pipeline.

## Web Aside ARCH:HCL HCL

### descriptions of Y86-64 processors

In this chapter, we have looked at portions of the HCL code for several simple logic designs and for the control logic for Y86-64 processors SEQ and PIPE. For reference, we provide documentation of the HCL language and complete HCL descriptions for the control logic of the two processors. Each of these descriptions requires only five to seven pages of HCL code, and it is worthwhile to study them in their entirety.

We enhanced the pipeline performance by adding forwarding logic to speed the sending of a result from one instruction to another. Several special cases require additional pipeline control logic to stall or cancel some of the pipeline stages.

Our design included rudimentary mechanisms to handle exceptions, where we make sure that only instructions up to the excepting instruction affect the programmer-visible state. Implementing a complete handling of exceptions would be significantly more challenging. Properly handling exceptions gets even more complex in systems that employ greater degrees of pipelining and parallelism.

In this chapter, we have learned several important lessons about processor design:

- **Managing complexity is a top priority.** We want to make optimum use of the hardware resources to get maximum performance at minimum cost. We did this by creating a very simple and uniform framework for processing all of the different instruction types. With this framework, we could share the hardware units among the logic for processing the different instruction types.
- **We do not need to implement the ISA directly.** A direct implementation of the ISA would imply a very sequential design. To achieve higher performance, we want to exploit the ability in hardware to perform many operations simultaneously. This led to the use of a pipelined design. By careful design and analysis, we can handle the various pipeline hazards, so that the overall effect of running a program exactly matches what would be obtained with the ISA model.
- **Hardware designers must be meticulous.** Once a chip has been fabricated, it is nearly impossible to correct any errors. It is very important to get the design right on the first try. This means

carefully analyzing different instruction types and combinations, even ones that do not seem to make sense, such as popping to the stack pointer. Designs must be thoroughly tested with systematic simulation test programs. In developing the control logic for PIPE, our design had a subtle bug that was uncovered only after a careful and systematic analysis of control combinations.

## 4.6.1 Y86-64 Simulators

The lab materials for this chapter include simulators for the SEQ and PIPE processors. Each simulator has two versions:

- The GUI (graphic user interface) version displays the memory, program code, and processor state in graphic windows. This provides a way to readily see how the instructions flow through the processors. The control panel also allows you to reset, single-step, or run the simulator interactively.
- The text version runs the same simulator, but it only displays information by printing to the terminal. This version is not as useful for debugging, but it allows automated testing of the processor.

The control logic for the simulators is generated by translating the HCL declarations of the logic blocks into C code. This code is then compiled and linked with the rest of the simulation code. This combination makes it possible for you to test out variants of the original designs using the simulators. Testing scripts are also available that thoroughly exercise the different instructions and the different hazard possibilities.

# Bibliographic Notes

For those interested in learning more about logic design, the Katz and Borriello logic design textbook [58] is a standard introductory text, emphasizing the use of hardware description languages. Hennessy and Patterson's computer architecture textbook [46] provides extensive coverage of processor design, including both simple pipelines, such as the one we have presented here, and advanced processors that execute more instructions in parallel. Shriver and Smith [101] give a very thorough presentation of an Intel-compatible x86-64 processor manufactured by AMD.

[OceanofPDF.com](http://OceanofPDF.com)

# Homework Problems

## 4.45

In [Section 3.4.2](#), the x86-64 `pushq` instruction was described as decrementing the stack pointer and then storing the register at the stack pointer location. So, if we had an instruction of the form `pushq REG`, for some register `REG`, it would be equivalent to the code sequence

```
subq $8,%rsp      Decrement stack pointer
movq REG, (%rsp)  Store REG on stack
```

- A. In light of analysis done in [Practice Problem 4.7](#), does this code sequence correctly describe the behavior of the instruction `pushq %rsp`? Explain.
- B. How could you rewrite the code sequence so that it correctly describes both the cases where `REG` is `%rsp` as well as any other register?

## 4.46

In [Section 3.4.2](#), the x86-64 `popq` instruction was described as copying the result from the top of the stack to the destination register and then incrementing the stack pointer. So, if we had an instruction of the form `popq REG`, it would be equivalent to the code sequence

```
movq (%rsp), REG      Read REG from stack
addq $8,%rsp          Increment stack pointer
```

- A. In light of analysis done in [Practice Problem 4.8](#), does this code sequence correctly describe the behavior of the instruction `popq %rsp`? Explain.
- B. How could you rewrite the code sequence so that it correctly describes both the cases where `REG` is `%rsp` as well as any other register?

## 4.47

Your assignment will be to write a Y86-64 program to perform bubblesort. For reference, the following C function implements bubblesort using array referencing:

```
1  /* Bubble sort: Array version */
2  void bubble_a(long *data, long count) {
3      long i, last ;
4      for (last = count-1; last > 0; last--) {
5          for (i = 0; i < last; i++)
6              if (data[i+1] < data[i]) {
7                  /* Swap adjacent elements */
8                  long t = data[i+1];
9                  data[i+1] = data[i];
10                 data[i] = t;
11             }
12         }
13     }
```

- A. Write and test a C version that references the array elements with pointers, rather than using array indexing.
- B. Write and test a Y86-64 program consisting of the function and test code. You may find it useful to pattern your implementation after x86-64 code generated by compiling your C code. Although pointer comparisons are normally done



using unsigned arithmetic, you can use signed arithmetic for this exercise.

## 4.48

Modify the code you wrote for [Problem 4.47](#) to implement the test and swap in the bubblesort function (lines 6-11) using no jumps and at most three conditional moves.

## 4.49

Modify the code you wrote for [Problem 4.47](#) to implement the test and swap in the bubblesort function (lines 6-11) using no jumps and just one conditional move.

## 4.50

In [Section 3.6.8](#), we saw that a common way to implement `switch` statements is to create a set of code blocks and then index those blocks using a jump table. Consider

```
#include <stdio.h>

/* Example use of switch statement */

long switchv(long idx) {
    long result = 0;
    switch(idx) {
        case 0:
            result = 0xaaa;
            break;
        case 2:
        case 5:
            result = 0xbbb;
            break;
        case 3:
            result = 0xccc;
            break;
        default :
            result = 0xddd;
    }
    return result;
}

/* Testing Code */
#define CNT 8
#define MINVAL -1

int main() {
    long vais [CNT];
    long i;
    for (i = 0; i < CNT; i++) {
```

```

        vals[i] = switchv(i + MINVAL);
        printf ("idx = %ld, val = 0x%lx\n", i + MINVAL,
vals [i] );
    }
    return 0;
}

```

**Figure 4.69** Switch statements can be translated into Y86-64 code.

This requires implementation of a jump table.

the C code shown in [Figure 4.69](#) for a function `switchv`, along with associated test code.

Implement `switchv` in Y86-64 using a jump table. Although the Y86-64 instruction set does not include an indirect jump instruction, you can get the same effect by pushing a computed address onto the stack and then executing the `ret` instruction. Implement test code similar to what is shown in C to demonstrate that your implementation of `switchv` will handle both the cases handled explicitly as well as those that trigger the `default` case.

## 4.51

**Practice Problem 4.3** introduced the `iaddq` instruction to add immediate data to a register. Describe the computations performed to implement this instruction. Use the computations for `irmovq` and `OPq` (**Figure 4.18**) as a guide.

## 4.52

The file `seq-full.hcl` contains the HCL description for SEQ, along with the declaration of a constant `IIADDQ` having hexadecimal value C, the instruction code for `iaddq`. Modify the HCL descriptions of the control logic blocks to implement the `iaddq` instruction, as described in **Practice Problem 4.3** and **Problem 4.51**. See the lab material for directions on how to generate a simulator for your solution and how to test it.

## 4.53

Suppose we wanted to create a lower-cost pipelined processor based on the structure we devised for PIPE— (Figure 4.41 [🔗](#)), without any bypassing. This design would handle all data dependencies by stalling until the instruction generating a needed value has passed through the write-back stage.

The file `pipe-stall.hcl` contains a modified version of the HCL code for PIPE in which the bypassing logic has been disabled. That is, the signals `e_valA` and `e_valB` are simply declared as follows:

```
## DO NOT MODIFY THE FOLLOWING CODE.
## No forwarding. valA is either valP or value from register
file
word d_valA = [
    D_icode in { ICALL, IJXX } : D_valP; # Use incremented
PC
    1 : d_rvalA; # Use value read from register file
];
## No forwarding. valB is value from register file
word d_valB = d_rvalB;
```

Modify the pipeline control logic at the end of this file so that it correctly handles all possible control and data hazards. As part of

your design effort, you should analyze the different combinations of control cases, as we did in the design of the pipeline control logic for PIPE. You will find that many different combinations can occur, since many more conditions require the pipeline to stall. Make sure your control logic handles each combination correctly. See the lab material for directions on how to generate a simulator for your solution and how to test it.

## 4.54

The `file pipe-full.hcl` contains a copy of the PIPE HCL description, along with a declaration of the constant value `IIADDQ`. Modify this file to implement the `iaddq` instruction, as described in [Practice Problem 4.3](#) and [Problem 4.51](#). See the lab material for directions on how to generate a simulator for your solution and how to test it.

## 4.55

The file `pipe-nt.hcl` contains a copy of the HCL code for PIPE, plus a declaration of the constant `J_YES` with value 0, the function code for an unconditional jump instruction. Modify the branch prediction logic so that it predicts conditional jumps as being not taken while continuing to predict unconditional jumps and `call` as being taken. You will need to devise a way to get `valC`, the jump target address, to pipeline register M to recover from mispredicted branches. See the lab material for directions on how to generate a simulator for your solution and how to test it.



## 4.56


The file `pipe-btfnt.hcl` contains a copy of the HCL code for PIPE, plus a declaration of the constant `J_YES` with value 0, the function code for an unconditional jump instruction. Modify the branch prediction logic so that it predicts conditional jumps as being taken when `valC < valP` (backward branch) and as being not taken when `valC ≥ valP` (forward branch). (Since Y86-64 does not support unsigned arithmetic, you should implement this test using a signed comparison.) Continue to predict unconditional jumps and `call` as being taken. You will need to devise a way to get both `valC` and `valP` to pipeline register M to recover from mispredicted branches. See the lab material for directions on how to generate a simulator for your solution and how to test it.

## 4.57

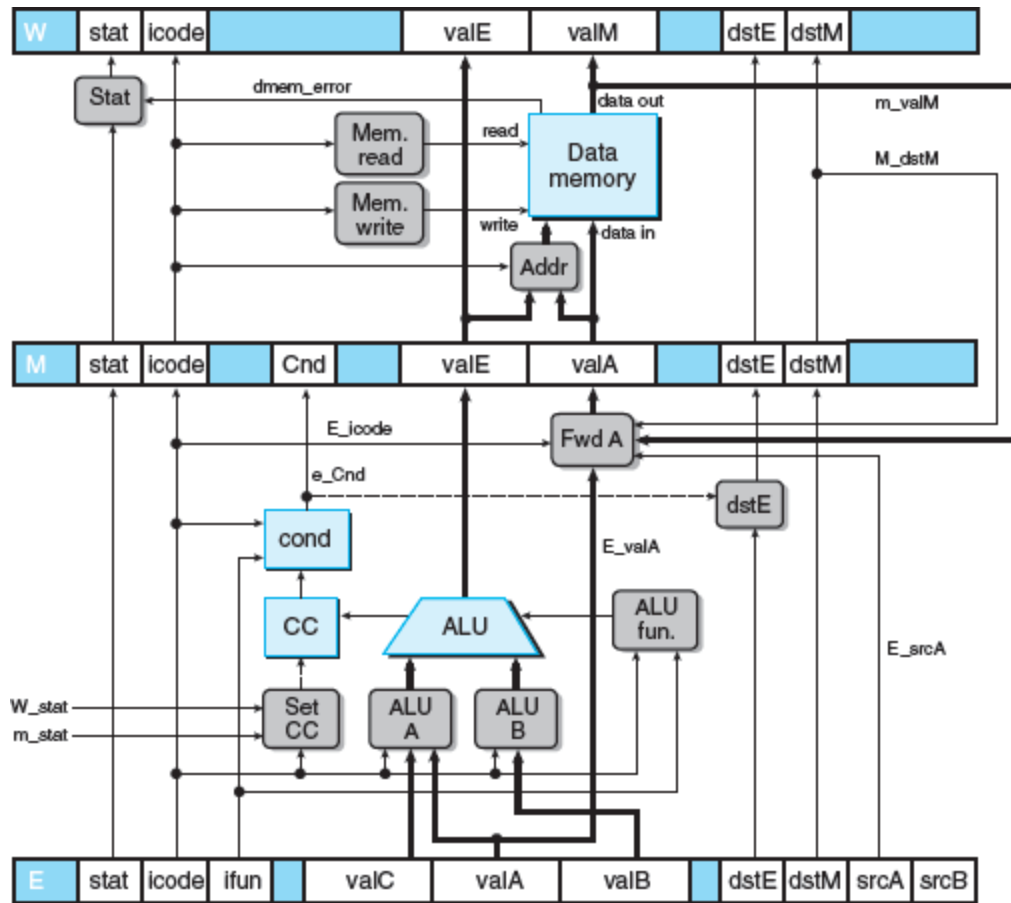
In our design of PIPE, we generate a stall whenever one instruction performs a *load*, reading a value from memory into a register, and the next instruction has this register as a source operand. When the source gets used in the execute stage, this stalling is the only way to avoid a hazard. For cases where the second instruction stores the source operand to memory, such as with an `rmmovq` or `pushq` instruction, this stalling is not necessary. Consider the following code examples:

```
1  mrmovq 0(%rcx),%rdx    # Load 1
2  pushq %rdx             # Store 1
3  nop
4  popq %rdx              # Load 2
5  rmmovq %rax,0(%rdx)    # Store 2
```


In lines 1 and 2, the `mrmovq` instruction reads a value from memory into `%rdx`, and the `pushq` instruction then pushes this value onto the stack. Our design for PIPE would stall the `pushq` instruction to avoid a load/use hazard. Observe, however, that the value of `%rdx` is not required by the `pushq` instruction until it reaches the memory stage. We can add an additional bypass path, as diagrammed in [Figure](#)

4.70 , to forward the memory output (signal `m_valM`) to the `valA` field in pipeline register M. On the next clock cycle, this forwarded value can then be written to memory. This technique is known as *load forwarding*.

Note that the second example (lines 4 and 5) in the code sequence above cannot make use of load forwarding. The value loaded by the `popq` instruction is



**Figure 4.70** Execute and memory stages capable of load forwarding.

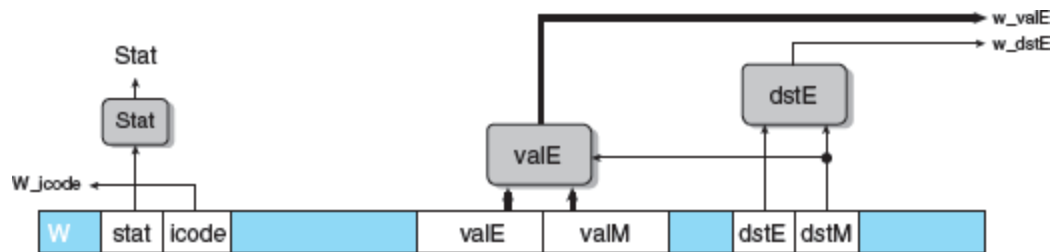
By adding a bypass path from the memory output to the source of valA in pipeline register M, we can use forwarding rather than stalling for one form of load/use hazard. This is the subject of [Problem 4.57](#) .

used as part of the address computation by the next instruction, and this value is required in the execute stage rather than the memory stage.

- A. Write a logic formula describing the detection condition for a load/use hazard, similar to the one given in [Figure 4.64](#), except that it will not cause a stall in cases where load forwarding can be used.
- B. The file `pipe-1f.hcl` contains a modified version of the control logic for PIPE. It contains the definition of a signal `e_valA` to implement the block labeled "Fwd A" in [Figure 4.70](#). It also has the conditions for a load/use hazard in the pipeline control logic set to zero, and so the pipeline control logic will not detect any forms of load/use hazards. Modify this HCL description to implement load forwarding. See the lab material for directions on how to generate a simulator for your solution and how to test it.

# 4.58

Our pipelined design is a bit unrealistic in that we have two write ports for the register file, but only the `popq` instruction requires two simultaneous writes to the register file. The other instructions could therefore use a single write port, sharing this for writing `valE` and `valM`. The following figure shows a modified version of the write-back logic, in which we merge the write-back register IDs (`w_dstE` and `w_dstM`) into a single signal `w_dstE` and the write-back values (`w_valE` and `w_valM`) into a single signal `w_valE`:



The logic for performing the merges is written in HCL as follows:

```

## Set E port register ID
word w_dstE = [
    ## writing from valM
    W_dstM != RNONE : W_dstM;
    1: W_dstE;
];

## Set E port value
word w_valE = [
    W_dstM != RNONE : W_valM;
    1: W_valE;
];

```

The control for these multiplexors is determined by `dstE`—when it indicates there is some register, then it selects the value for port E, and otherwise it selects the value for port M.

In the simulation model, we can then disable register port M, as shown by the following HCL code:

```
## Disable register port M
## Set M port register ID
word w_dstM = RNONE;


## Set M port value
word w_valM = 0;
```

The challenge then becomes to devise a way to handle `popq`. One method is to use the control logic to dynamically process the instruction `popq rA` so that it has the same effect as the two-instruction sequence

```
iaddq $8, %rsp
mrmovq -8(%rsp), rA
```




(See [Practice Problem 4.3](#) for a description of the `iaddq` instruction.) Note the ordering of the two instructions to make sure `popq %rsp` works properly. You can do this by having the logic in the decode stage treat `popq` the same as it would the `iaddq` listed above, except that it predicts the next PC to be equal to the current PC. On the next cycle, the `popq` instruction is refetched, but the instruction code is converted to a special value `IP0P2`. This is treated as a special instruction that has the same behavior as the `mrmovq` instruction listed above.



The file `pipe-lw.hcl` contains the modified write port logic described above. It contains a declaration of the constant `IP0P2` having hexadecimal value E. It also contains the definition of a signal `f_icode` that generates the icode field for pipeline register D. This definition can be modified to insert the instruction code `IP0P2` the second time the `popq` instruction is fetched. The HCL file also contains a declaration of the signal `f_pc`, the value of the program counter generated in the fetch stage by the block labeled "Select PC" ([Figure 4.57](#) )

Modify the control logic in this file to process `popq` instructions in the manner we have described. See the lab material for directions on how to generate a simulator for your solution and how to test it.

## 4.59

Compare the performance of the three versions of bubblesort ([Problems 4.47](#) , [4.48](#) , and [4.49](#) ). Explain why one version performs better than the other.

# Solutions to Practice Problems

# Solution to Problem 4.1 (page 360)

Encoding instructions by hand is rather tedious, but it will solidify your understanding of the idea that assembly code gets turned into byte sequences by the assembler. In the following output from our Y86-64 assembler, each line shows an address and a byte sequence that starts at that address:

```
1      0x100:                | .pos 0x100 # Start
code at address 0x100
2      0x100: 30f30f000000000000000000 |      irmovq $15,%rbx
3      0x10a: 2031                |      rrmovq %rbx,%rcx
4      0x10c:                | loop:
5      0x10c: 4013fdffffffffffffffffffff |      rmmovq
%rcx, -3(%rbx)
6      0x116: 6031                |      addq %rbx,%rcx
7      0x118: 700c01000000000000000000 |      jmp loop
```

Several features of this encoding are worth noting:

- Decimal 15 (line 2) has hex representation `0x00000000000000000000000f`. Writing the bytes in reverse order gives `0f 00 00 00 00 00 00 00 00`.

- Decimal -3 (line 5) has hex representation `0xfffffffffffffffd`.  
Writing the bytes in reverse order gives `fd ff ff ff ff ff ff ff`.
- The code starts at address `0x100`. The first instruction requires 10 bytes, while the second requires 2. Thus, the loop target will be `0x0000010c`. Writing these bytes in reverse order gives `0c 01 00 00 00 00 00 00 00 00`.

# Solution to Problem 4.2 (page 360)

Decoding a byte sequence by hand helps you understand the task faced by a processor. It must read byte sequences and determine what instructions are to be executed. In the following, we show the assembly code used to generate each of the byte sequences. To the left of the assembly code, you can see the address and byte sequence for each instruction.

- A. Some operations with immediate data and address displacements:

```
0x100: 30f3fcffffffffffffffff | irmovq $-4,%rbx
0x10a: 40630008000000000000 | rmmovq
%rsi,0x800(%rbx)
0x114: 00 | halt
```

- B. Code including a function call:

```

0x200: a06f          |      pushq %rsi
0x202: 800c0200000000000000 |      call proc
0x20b: 00            |      halt
0x20c:              |      proc:
0x20c: 30f30a00000000000000 |      irmovq $10,%rbx
0x216: 90          |      ret

```

C. Code containing illegal instruction specifier byte `0xf0`:

```

0x300: 50540700000000000000 |      mrmovq
7(%rsp),%rbp
0x30a: 10            |      nop
0x30b: f0          |      .byte 0xf0 #
Invalid instruction code
0x30c: b01f          |      popq %rcx

```

D. Code containing a jump operation:

```

0x400:              |      loop:
0x400: 6113          |      subq %rcx, %rbx
0x402: 73000400000000000000 |      je loop
0x40b: 00            |      halt

```

E. Code containing an invalid second byte in a `pushq` instruction:

```
0x500: 6362          |      xorq %rsi,%rdx
0x502: a0         |      .byte 0xa0 # pushq
instruction code
0x503: f0         |      .byte 0xf0 # Invalid
register specifier byte
```

# Solution to Problem 4.3 (page 369)

Using the `iaddq` instruction, we can rewrite the `sum` function as

```
# long sum(long *start, long count)
# start in %rdi, count in %rsi
sum:
    xorq %rax,%rax        # sum = 0
    andq %rsi,%rsi       # Set condition codes
    jmp test
loop:
    mrmovq (%rdi),%r10    # Get *start
    addq %r10,%rax       # Add to sum
    iaddq $8,%rdi        # start++
    iaddq $-1,%rsi       # count--
test :
    jne loop             # Stop when 0
    ret
```



# Solution to Problem 4.4 (page 370)

Gcc, running on an x86-64 machine, produces the following code for `rsum`:

```
long rsum(long * start, long count)
start in %rdi, count in %rsi
rsum:
    movl    $0, %eax
    testq   %rsi, %rsi
    jle    .L9
    pushq   %rbx
    movq   (%rdi), %rbx
    subq   $1, %rsi
    addq   $8, %rdi
    call   rsum
    addq   %rbx, %rax
    popq   %rbx
.L9:
    rep; ret
```

This can easily be adapted to produce Y86-64 code:

```

# long rsum(long *start, long count)
# start in %rdi, count in %rsi
rsum:
    xorq %rax,%rax          # Set return value to 0
    andq %rsi,%rsi         # Set condition codes
    je return              # If count == 0, return 0
    pushq %rbx             # Save callee-saved register
    mrmovq (%rdi), %rbx    # Get *start
    irmovq $-1,%r10
    addq %r10,%rsi         # count--
    irmovq $8,%r10
    addq %r10,%rdi         # start++
    call rsum
    addq %rbx,%rax         # Add *start to sum
    popq %rbx             # Restore callee-saved register
return:
    ret

```

# Solution to Problem 4.5 (page 370)

This problem gives you a chance to try your hand at writing assembly code.

```

1      # long absSum(long *start, long count)
2      # start in %rdi, count in %rsi
3      absSum:
4          irmovq $8,%r8          # Constant 8
5          irmovq $1,%r9          # Constant 1
6          xorq %rax,%rax         # sum = 0
7          andq %rsi,%rsi        # Set condition
codes
8          jmp test
9      loop :
10         mrmovq (%rdi),%r10      # x = *start
11         xorq %r11,%r11         # Constant 0
12         subq %r10,%r11         # -x
13         jle pos                # Skip if -x <=
0
14         rrmovq %r11,%r10       # x = -x
15     pos:
16         addq %r10,%rax         # Add to sum
17         addq %r8,%rdi          # start++
18         subq %r9,%rsi          # count--
19     test:
20         jne loop                # Stop when 0
21         ret

```

## Solution to Problem 4.6 [↗](#)(page 370)

This problem gives you a chance to try your hand at writing assembly code with conditional moves. We show only the code for the loop. The rest is the same as for [Problem 4.5](#) [↗](#):

```
9      loop :
10     mrmovq (%rdi),%r10      # x = *start
11     xorq %r11,%r11         # Constant 0
12     subq %r10,%r11         # -x
13     cmovg %r11,%r10        # If -x > 0 then x = -x
14     addq %r10,%rax         # Add to sum
15     addq %r8,%rdi          # start++
16     subq %r9,%rsi         # count--
17     test:
18     jne loop               # Stop when 0
```

## Solution to Problem 4.7 (page 370)

Although it is hard to imagine any practical use for this particular instruction, it is important when designing a system to avoid any ambiguities in the specification. We want to determine a reasonable convention for the instruction's behavior and to make sure each of our implementations adheres to this convention.

The `subq` instruction in this test compares the starting value of `%rsp` to the value pushed onto the stack. The fact that the result of this subtraction is zero implies that the old value of `%rsp` gets pushed.

## Solution to Problem 4.8 (page 371)

It is even more difficult to imagine why anyone would want to pop to the stack pointer. Still, we should decide on a convention and stick with it. This code sequence pushes `0xabcd` onto the stack, pops to `%rsp`, and returns the popped value. Since the result equals `0xabcd`, we can deduce that `popq %rsp` sets the stack pointer to the value read from memory. It is therefore equivalent to the instruction `mrmovq (%rsp), %rsp`.

## Solution to Problem 4.9 [↗](#)(page 374)

The EXCLUSIVE-OR function requires that the 2 bits have opposite values:

```
bool xor = (!a && b) || (a && !b);
```

In general, the signals `eq` and `xor` will be complements of each other. That is, one will equal 1 whenever the other is 0.

## Solution to Problem 4.10 [↗](#)(page 377)

The outputs of the EXCLUSIVE-OR circuits will be the complements of the bit equality values. Using DeMorgan's laws (Web Aside `DATA:BOOL` on page 52), we can implement AND using OR and NOT, yielding the circuit shown in [Figure 4.71 \[↗\]\(#\)](#).

# Solution to Problem 4.11 [\(page 379\)](#)

We can see that the second part of the case expression can be written as

```
B <= C : B;
```

Since the first line will detect the case where A is the minimum element, the second line need only determine whether B or C is minimum.



# Solution to Problem 4.12 (page 380)

This design is a variant of the one to find the minimum of the three inputs:

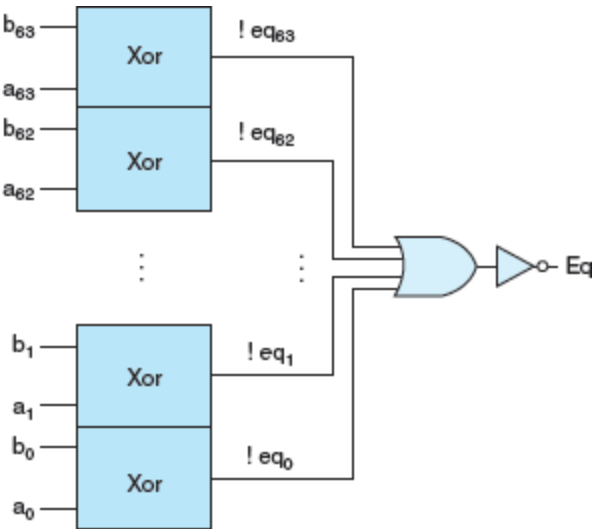


Figure 4.71 Solution for Problem 4.10.

```
word Med3 = [
```

```
    A <= B && B <= C : B;
```

```
    C <= B && B <= A : B;
```

```
    B <= A && A <= C : A;
```

```
    C <= A && A <= B : A;
```

```
    1 : C;
```

```
];
```

## Solution to Problem 4.13 (page 387)

These exercises help make the stage computations more concrete. We can see from the object code that this instruction is located at address `0x016`. It consists of 10 bytes, with the first two being `0x30` and `0xf4`. The last 8 bytes are a byte-reversed version of `0x000000000000000080` (decimal 128).

This instruction sets register `%rsp` to 128 and increments the PC by 10.

## Solution to Problem 4.14 (page 390)

We can see that the instruction is located at address `0x02c` and consists of 2 bytes with values `0xb0` and `0x00f`. Register `%rsp` was set to 120 by the `pushq` instruction (line 6), which also stored 9 at this memory location.

The instruction sets `%rax` to 9, sets `%rsp` to 128, and increments the PC by 2.

## Solution to Problem 4.15 (page 391)

Tracing the steps listed in [Figure 4.20 !\[\]\(e78f798d4ea5c530c9db49e7d26e6b95\_img.jpg\)](#) with `rA` equal to `%rsp`, we can see that in the memory stage the instruction will store `valA`, the original value of the stack pointer, to memory, just as we found for x86-64.

## Solution to Problem 4.16 (page 392)

Tracing the steps listed in [Figure 4.20 !\[\]\(8af806fb1314382d09bc5ec5b767526c\_img.jpg\)](#) with rA equal to `%rsp`, we can see that both of the write-back operations will update `%rsp`. Since the one writing valM would occur last, the net effect of the instruction will be to write the value read from memory to `%rsp`, just as we saw for x86-64.

## Solution to Problem 4.17 (page 393)

Implementing conditional moves requires only minor changes from register-to-register moves. We simply condition the write-back step on the outcome of the conditional test:

## Solution to Problem 4.18 (page 394)

We can see that this instruction is located at address `0x037` and is 9 bytes long. The first byte has value `0x80`, while the last 8 bytes are a byte-reversed version of `0x0000000000000041`, the call target. The stack pointer was set to 128 by the `popq` instruction (line 7).

The effect of this instruction is to set `%rsp` to 120, to store `0x040` (the return address) at this memory address, and to set the PC to `0x041` (the call target).

# Solution to Problem 4.19 (page 406)

All of the HCL code in this and other practice problems is straightforward, but trying to generate it yourself will help you think about the different instructions and how they are processed. For this problem, we can simply look at the set of Y86-64 instructions ([Figure 4.2](#)) and determine which have a constant field.

```
bool need_valC =  
    icode in { IIRMOVQ, IRMMOVQ, IMRMVQ, IJXX, ICALL };
```

# Solution to Problem 4.20 (page 407)

This code is similar to the code for srcA.

```
word srcB = [  
    icode in { IOPQ, IRMMOVQ, IMRMVQ } : rB;  
    icode in { IPUSHQ, IPOPQ, ICALL, IRET } : RRSP;  
    1 : RNONE; # Don't need register  
];
```



## Solution to Problem 4.21 [□](#)(page 408)

This code is similar to the code for dstE.

```
word dstM = [  
    icode in { IMRMOVQ, IPOPOP } : rA;  
    1 : RNONE; # Don't write any register  
];
```

## Solution to Problem 4.22 [□](#)(page 408)

As we found in [Practice Problem 4.16](#) [□](#), we want the write via the M port to take priority over the write via the E port in order to store the value read from memory into `%rsp`.

# Solution to Problem 4.23 (page 409)

This code is similar to the code for aluA.

```
word aluB = [  
    icode in { IRMMOVQ, IMRMVQ, IOPQ, ICALL, IPUSHQ, IRET,  
    IPOPOPQ } : valB;  
    icode in { IRRMOVQ, IIRMOVQ } : 0;  
    # Other instructions don't need ALU  
];
```

# Solution to Problem 4.24 (page 409)

Implementing conditional moves is surprisingly simple: we disable writing to the register file by setting the destination register to `RNONE` when the condition does not hold.

```
word dstE = [  
    icode in { IRRMOVQ } && Cnd : rB;  
    icode in { IIRMOVQ, IOPQ } : rB;  
    icode in { IPUSHQ, IPOPQ, ICALL, IRET } : RRSP;  
    1 : RNONE; # Don't write any register  
];
```

## Solution to Problem 4.25 [\(page 410\)](#)

This code is similar to the code for `mem_addr`.

```
word mem_data = [  
    # Value from register  
    icode in { IRMMOVQ, IPUSHQ } : valA;  
    # Return PC  
    icode == ICALL : valP;  
    # Default: Don't write anything  
];
```

## Solution to Problem 4.26 [\(page 410\)](#)

This code is similar to the code for `mem_read`.

```
bool mem_write = icode in { IRMMOVQ, IPUSHQ, ICALL };
```

# Solution to Problem 4.27 (page 411)

Computing the Stat field requires collecting status information from several stages:

```
## Determine instruction status
word Stat = [
    imem_error | | dmem_error : SADR;
    !instr_valid: SINS;
    icode == IHALT : SHLT;
    1 : SAOK;
];
```

## Solution to Problem 4.28 (page 417)

This problem is an interesting exercise in trying to find the optimal balance among a set of partitions. It provides a number of opportunities to compute throughputs and latencies in pipelines.

- A. For a two-stage pipeline, the best partition would be to have blocks A, B, and C in the first stage and D, E, and F in the second. The first stage has a delay of 170 ps, giving a total cycle time of  $170 + 20 = 190$  ps. We therefore have a throughput of 5.26 GIPS and a latency of 380 ps.
- B. For a three-stage pipeline, we should have blocks A and B in the first stage, blocks C and D in the second, and blocks E and F in the third. The first two stages have a delay of 110 ps, giving a total cycle time of 130 ps and a throughput of 7.69 GIPS. The latency is 390 ps.
- C. For a four-stage pipeline, we should have block A in the first stage, blocks B and C in the second, block D in the third, and blocks E and F in the fourth. The second stage requires 90 ps, giving a total cycle time of 110 ps and a throughput of 9.09 GIPS. The latency is 440 ps.
- D. The optimal design would be a five-stage pipeline, with each block in its own stage, except that the fifth stage has blocks E and F. The cycle time is  $80 + 20 = 100$  ps, for a throughput of around 10.00 GIPS and a latency of 500 ps. Adding more

stages would not help, since we cannot run the pipeline any faster than one cycle every 100 ps.

## Solution to Problem 4.29 (page 418)

Each stage would have combinational logic requiring  $300/k$  ps and a pipeline register requiring 20 ps.

- A. The total latency would be  $300 + 20k$  ps, while the throughput (in GIPS) would be

$$\frac{1,000}{\frac{300}{k} + 20} = \frac{1,000k}{300 + 20k}$$

- B. As we let  $k$  go to infinity, the throughput becomes  $1,000/20 = 50$  GIPS. Of course, the latency would approach infinity as well.

This exercise quantifies the diminishing returns of deep pipelining. As we try to subdivide the logic into many stages, the latency of the pipeline registers becomes a limiting factor.

## Solution to Problem 4.30 (page 449)

This code is very similar to the corresponding code for SEQ, except that we cannot yet determine whether the data memory will generate an error signal for this instruction.

```
# Determine status code for fetched instruction
word f_stat = [
    imem_error: SADR;
    !instr_valid : SINS;
    f_icode == IHALT : SHLT;
    1 : SAOK;
];
```



# Solution to Problem 4.31 (page 449)

This code simply involves prefixing the signal names in the code for SEQ with `d_` and `D_`.

```
word d_dstE = [  
    D_icode in { IRRMOVQ, IIRMOVQ, IOPQ } : D_rB;  
    D_icode in { IPUSHQ, IPOPQ, ICALL, IRET } :  
RRSP;  
    1 : RNONE; # Don't write any register  
];
```

# Solution to Problem 4.32 (page 452)

The `rrmovq` instruction (line 5) would stall for one cycle due to a load/use hazard caused by the `popq` instruction (line 4). As it enters the decode stage, the `popq` instruction would be in the memory stage, giving both `M_dstE` and `M_dstM` equal to `%rsp`. If the two cases were reversed, then the write back from `M_valE` would take priority, causing the incremented stack pointer to be passed as the argument to the `rrmovq` instruction. This would not be consistent with the convention for handling `popq %rsp` determined in [Practice Problem 4.8 !\[\]\(529949c2c3dadbaa4e538e8c643454bc\_img.jpg\)](#).

# Solution to Problem 4.33 (page 452)

This problem lets you experience one of the important tasks in processor design—devising test programs for a new processor. In general, we should have test programs that will exercise all of the different hazard possibilities and will generate incorrect results if some dependency is not handled properly.

For this example, we can use a slightly modified version of the program shown in [Practice Problem 4.32](#):

```
1    irmovq $5, %rdx
2    irmovq $0x100,%rsp
3    rmmovq %rdx,0(%rsp) popq%rsp
5    nop
6    nop
7    rrmovq %rsp,%rax
```

The two `nop` instructions will cause the `popq` instruction to be in the write-back stage when the `rrmovq` instruction is in the decode stage. If the two forwarding sources in the write-back stage are given the

wrong priority, then register `%rax` will be set to the incremented program counter rather than the value read from memory.

## Solution to Problem 4.34 [\(page 453\)](#)

This logic only needs to check the five forwarding sources:

```
word d_valB = [  
    d_srcB == e_dstE : e_valE;      # Forward valE from  
execute  
    d_srcB == M_dstM : m_valM;      # Forward valM from  
memory  
    d_srcB == M_dstE : M_valE;      # Forward valE from  
memory  
    d_srcB == W_dstM : W_valM;      # Forward valM from  
write back  
    d_srcB == W_dstE : W_valE;      # Forward valE from  
write back  
    1 : d_rvalB; # Use value read from register file  
];
```

# Solution to Problem 4.35 (page 454)

This change would not handle the case where a conditional move fails to satisfy the condition, and therefore sets the `dstE` value to `RNONE`. The resulting value could get forwarded to the next instruction, even though the conditional transfer does not occur.

```
1    irmovq $0x123,%rax
2    irmovq $0x321,%rdx
3    xorq %rcx/Zrcx      # CC = 100
4    cmovne %rax,%rdx   # Not transferred
5    addq %rdx,%rdx     # Should be 0x642
6    halt
```

This code initializes register `%rdx` to `0x321`. The conditional data transfer does not take place, and so the final `addq` instruction should double the value in `%rdx` to `0x642`. With the altered design, however, the conditional move source value `0x321` gets forwarded into ALU input `valA`, while input `valB` correctly gets operand value `0x123`. These inputs get added to produce result `0x444`.

## Solution to Problem 4.36 (page 455)

This code completes the computation of the status code for this instruction.

```
## Update the status
word m_stat = [
    dmem_error : SADR;
    1 : M_stat;
];
```

# Solution to Problem 4.37 [↗](#)(page 461)

The following test program is designed to set up control combination A ([Figure 4.67 ↗](#)) and detect whether something goes wrong:

```

1      # Code to generate a combination of not-taken branch and
ret
2      irmovq Stack, %rsp
3      irmovq rtnp,%rax
4      pushq %rax          # Set up return pointer
5      xorq %rax,%rax     # Set Z condition code
6      jne target        # Not taken (First part
of combination)
7      irmovq $1,%rax     # Should execute this
8      halt
9      target: ret       # Second part of
combination
10     irmovq $2,%rbx     # Should not execute
this
11     halt
12     rtnp: irmovq $3,%rdx # Should not execute
this
13     halt
14     .pos 0x40
15     Stack:

```

This program is designed so that if something goes wrong (for example, if the `ret` instruction is actually executed), then the program will execute one of the extra `irmovq` instructions and then halt. Thus, an error in the pipeline would cause some register to be



updated incorrectly. This code illustrates the care required to implement a test program. It must set up a potential error condition and then detect whether or not an error occurs.

## Solution to Problem 4.38 [□](#)(page 462)

The following test program is designed to set up control combination B ([Figure 4.67 □](#)). The simulator will detect a case where the bubble and stall control signals for a pipeline register are both set to zero, and so our test program need only set up the combination for it to be detected. The biggest challenge is to make the program do something sensible when handled correctly.

```

1      # Test instruction that modifies %esp followed by ret
2      irmovq mem,%rbx
3      mrmovq 0(%rbx),%rsp      # Sets %rsp to point to
return point
4      ret                      # Returns to return
point
5      halt                    #
6      rtnpt: irmovq $5,%rsi    # Return point
7      halt
8      .pos 0x40
9      mem:    .quad stack      # Holds desired stack
pointer
10     .pos 0x50
11     stack: .quad rtnpt      # Top of stack: Holds
return point

```

This program uses two initialized words in memory. The first word (`mem`) holds the address of the second (`stack`--the desired stack pointer). The second word holds the address of the desired return point for the `ret` instruction. The program loads the stack pointer into `%rsp` and executes the `ret` instruction.

# Solution to Problem 4.39 (page 463)

From [Figure 4.66](#), we can see that pipeline register D must be stalled for a load/use hazard:

```
bool D_stall =  
    # Conditions for a load/use hazard  
    E_icode in { IMRMOVQ, IPOPOQ } &&  
    E_dstM in { d_srcA, d_srcB };
```

# Solution to Problem 4.40 (page 464)

From [Figure 4.66](#), we can see that pipeline register E must be set to bubble for a load/use hazard or for a mispredicted branch:

```
bool E_bubble =  
    # Mispredicted branch  
    (E_icode == IJXX && !e_Cnd) ||  
    # Conditions for a load/use hazard  
    E_icode in { IMRMOVQ, IPOPOP } &&  
    E_dstM in { d_srcA, d_srcB};
```

# Solution to Problem 4.41 (page 464)

This control requires examining the code of the executing instruction and checking for exceptions further down the pipeline.

```
## Should the condition codes be updated?  
bool set_cc = E_icode == IOPQ &&  
    # State changes only during normal operation  
    !m_stat in { SADR, SINS, SHLT } && !W_stat in { SADR,  
SINS, SHLT };
```

# Solution to Problem 4.42 (page 464)

Injecting a bubble into the memory stage on the next cycle involves checking for an exception in either the memory or the write-back stage during the current cycle.

```
# Start injecting bubbles as soon as exception passes through
memory stage
bool M_bubble = m_stat in { SADR, SINS, SHLT } || w_stat in { SADR,
SINS, SHLT };
```

For stalling the write-back stage, we check only the status of the instruction in this stage. If we also stalled when an excepting instruction was in the memory stage, then this instruction would not be able to enter the write-back stage.

```
bool w_stall = w_stat in { SADR, SINS, SHLT };
```

## Solution to Problem 4.43 (page 468)

We would then have a misprediction frequency of 0.35, giving  $mp = 0.20 \times 0.35 \times 2 = 0.14$ , giving an overall CPI of 1.25. This seems like a fairly marginal gain, but it would be worthwhile if the cost of implementing the new branch prediction strategy were not too high.



# Solution to Problem 4.44 (page 468)

This simplified analysis, where we focus on the inner loop, is a useful way to estimate program performance. As long as the array is sufficiently large, the time spent in other parts of the code will be negligible.

- A. The inner loop of the code using the conditional jump has 11 instructions, all of which are executed when the array element is zero or negative, and 10 of which are executed when the array element is positive. The average is 10.5. The inner loop of the code using the conditional move has 10 instructions, all of which are executed every time.
- B. The loop-closing jump will be predicted correctly, except when the loop terminates. For a very long array, this one misprediction will have a negligible effect on the performance. The only other source of bubbles for the jump-based code is the conditional jump, depending on whether or not the array element is positive. This will cause two bubbles, but it only occurs 50% of the time, so the average is 1.0. There are no bubbles in the conditional move code.
- C. Our conditional jump code requires an average of  $10.5 + 1.0 = 11.5$  cycles per array element (11 cycles in the best case and 12 cycles in the worst), while our conditional move code requires 10.0 cycles in all cases.

Our pipeline has a branch misprediction penalty of only two cycles—far better than those for the deep pipelines of higher-performance processors. As a result, using conditional moves does not affect program performance very much.

[OceanofPDF.com](http://OceanofPDF.com)

---

# Chapter 5 Optimizing Program Performance

---

5.1 Capabilities and Limitations of Optimizing Compilers	498	<a href="#">□</a>
5.2 Expressing Program Performance	502	<a href="#">□</a>
5.3 Program Example	504	<a href="#">□</a>
5.4 Eliminating Loop Inefficiencies	508	<a href="#">□</a>
5.5 Reducing Procedure Calls	512	<a href="#">□</a>
5.6 Eliminating Unneeded Memory References	514	<a href="#">□</a>
5.7 Understanding Modern Processors	517	<a href="#">□</a>
5.8 Loop Unrolling	531	<a href="#">□</a>
5.9 Enhancing Parallelism	536	<a href="#">□</a>
5.10 Summary of Results for Optimizing Combining Code	547	<a href="#">□</a>
5.11 Some Limiting Factors	548	<a href="#">□</a>
5.12 Understanding Memory Performance	553	<a href="#">□</a>
5.13 Life in the Real World: Performance Improvement Techniques	561	<a href="#">□</a>
5.14 Identifying and Eliminating Performance Bottlenecks	562	<a href="#">□</a>
5.15 Summary	568	<a href="#">□</a>
Bibliographic Notes	569	<a href="#">□</a>
Homework Problems	570	<a href="#">□</a>
Solutions to Practice Problems	573	<a href="#">□</a>

*The primary objective in writing a program must be to make it work correctly under all possible conditions. A program that runs fast but gives incorrect results serves no useful purpose. Programmers must write clear and concise code, not only so that they can make sense of it, but also so that others can read and understand the code during code reviews and when modifications are required later.*

*On the other hand, there are many occasions when making a program run fast is also an important consideration. If a program must process video frames or network packets in real time, then a slow-running program will not provide the needed functionality. When a computational task is so demanding that it requires days or weeks to execute, then making it run just 20% faster can have significant impact. In this chapter, we will explore how to make programs run faster via several different types of program optimization.*

*Writing an efficient program requires several types of activities. First, we must select an appropriate set of algorithms and data structures. Second, we must write source code*

*that the compiler can effectively optimize to turn into efficient executable code. For this second part, it is important to understand the capabilities and limitations of optimizing compilers.*

*Seemingly minor changes in how a program is written can make large differences in how well a compiler can optimize it. Some programming languages are more easily optimized than others. Some features of C, such as the ability to perform pointer arithmetic and casting, make it challenging for a compiler to optimize.*

*Programmers can often write their programs in ways that make it easier for compilers to generate efficient code. A third technique for dealing with especially demanding computations is to divide a task into portions that can be computed in parallel, on some combination of multiple cores and multiple processors. We will defer this aspect of performance enhancement to [Chapter 12](#). Even when exploiting parallelism, it is important that each parallel thread execute with maximum performance, and so the material of this chapter remains relevant in any case.*

*In approaching program development and optimization, we must consider how the code will be used and what critical factors affect it. In*

*general, programmers must make a trade-off between how easy a program is to implement and maintain, and how fast it runs. At an algorithmic level, a simple insertion sort can be programmed in a matter of minutes, whereas a highly efficient sort routine may take a day or more to implement and optimize. At the coding level, many low-level optimizations tend to reduce code readability and modularity, making the programs more susceptible to bugs and more difficult to modify or extend. For code that will be executed repeatedly in a performance-critical environment, extensive optimization may be appropriate. One challenge is to maintain some degree of elegance and readability in the code despite extensive transformations.*

*We describe a number of techniques for improving code performance. Ideally, a compiler would be able to take whatever code we write and generate the most efficient possible machine-level program having the specified behavior. Modern compilers employ sophisticated forms of analysis and optimization, and they keep getting better. Even the best compilers, however, can be thwarted by optimization blockers—aspects of the program's behavior that depend strongly on the execution*

*environment. Programmers must assist the compiler by writing code that can be optimized readily.*

*The first step in optimizing a program is to eliminate unnecessary work, making the code perform its intended task as efficiently as possible. This includes eliminating unnecessary function calls, conditional tests, and memory references. These optimizations do not depend on any specific properties of the target machine.*

*To maximize the performance of a program, both the programmer and the compiler require a model of the target machine, specifying how instructions are processed and the timing characteristics of the different operations. For example, the compiler must know timing information to be able to decide whether it should use a multiply instruction or some combination of shifts and adds. Modern computers use sophisticated techniques to process a machine-level program, executing many instructions in parallel and possibly in a different order than they appear in the program. Programmers must understand how these processors work to be able to tune their*



*programs for maximum speed. We present a high-level model of such a machine based on recent designs of Intel and AMD processors. We also devise a graphical data-flow notation to visualize the execution of instructions by the processor, with which we can predict program performance.*

*With this understanding of processor operation, we can take a second step in program optimization, exploiting the capability of processors to provide instruction-level parallelism, executing multiple instructions simultaneously. We cover several program transformations that reduce the data dependencies between different parts of a computation, increasing the degree of parallelism with which they can be executed.*

*We conclude the chapter by discussing issues related to optimizing large programs. We describe the use of code profilers—tools that measure the performance of different parts of a program. This analysis can help find inefficiencies in the code and identify the parts of the program on which we should focus our optimization efforts.*

*In this presentation, we make code optimization look like a simple linear process of applying a series of transformations to the code in a particular order. In fact, the task is not nearly so straightforward. A fair amount of trial-and-error experimentation is required. This is especially true as we approach the later optimization stages, where seemingly small changes can cause major changes in performance and some very promising techniques prove ineffective. As we will see in the examples that follow, it can be difficult to explain exactly why a particular code sequence has a particular execution time. Performance can depend on many detailed features of the processor design for which we have relatively little documentation or understanding. This is another reason to try a number of different variations and combinations of techniques.*

*Studying the assembly-code representation of a program is one of the most effective means for gaining an understanding of the compiler and how the generated code will run. A good strategy is to start by looking carefully at the code for the inner loops, identifying performance-reducing attributes such as excessive memory references and poor use of*

*registers. Starting with the assembly code, we can also predict what operations will be performed in parallel and how well they will use the processor resources. As we will see, we can often determine the time (or at least a lower bound on the time) required to execute a loop by identifying critical paths, chains of data dependencies that form during repeated executions of a loop. We can then go back and modify the source code to try to steer the compiler toward more efficient implementations.*

*Most major compilers, including gcc, are continually being updated and improved, especially in terms of their optimization abilities. One useful strategy is to do only as much rewriting of a program as is required to get it to the point where the compiler can then generate efficient code. By this means, we avoid compromising the readability, modularity, and portability of the code as much as if we had to work with a compiler of only minimal capabilities. Again, it helps to iteratively modify the code and analyze its performance both through measurements and by examining the generated assembly code.*

*To novice programmers, it might seem strange to keep modifying the source code in an attempt to coax the compiler into generating efficient code, but this is indeed how many high-performance programs are written. Compared to the alternative of writing code in assembly language, this indirect approach has the advantage that the resulting code will still run on other machines, although perhaps not with peak performance.*

[OceanofPDF.com](http://OceanofPDF.com)

# 5.1 Capabilities and Limitations of Optimizing Compilers

Modern compilers employ sophisticated algorithms to determine what values are computed in a program and how they are used. They can then exploit opportunities to simplify expressions, to use a single computation in several different places, and to reduce the number of times a given computation must be performed. Most compilers, including `gcc`, provide users with some control over which optimizations they apply. As discussed in [Chapter 3](#), the simplest control is to specify the *optimization level*. For example, invoking `gcc` with the command-line option `-Og` specifies that it should apply a basic set of optimizations.

Invoking `gcc` with option `-O1` or higher (e.g., `-O2` or `-O3`) will cause it to apply more extensive optimizations. These can further improve program performance, but they may expand the program size and they may make the program more difficult to debug using standard debugging tools. For our presentation, we will mostly consider code compiled with optimization level `-O1`, even though level `-O2` has become the accepted standard for most software projects that use `gcc`. We purposely limit the level of optimization to demonstrate how different ways of writing a function in C can affect the efficiency of the code generated by a compiler. We will find that we can write C

code that, when compiled just with option `-O1`, vastly outperforms a more naive version compiled with the highest possible optimization levels.

Compilers must be careful to apply only *safe* optimizations to a program, meaning that the resulting program will have the exact same behavior as would an unoptimized version for all possible cases the program may encounter, up to the limits of the guarantees provided by the C language standards. Constraining the compiler to perform only safe optimizations eliminates possible sources of undesired run-time behavior, but it also means that the programmer must make more of an effort to write programs in a way that the compiler can then transform into efficient machine-level code. To appreciate the challenges of deciding which program transformations are safe or not, consider the following two procedures:

```
|  
1 void twiddle1(long *xp, long *yp)  
2 {  
3     *xp += *yp;  
4     *xp += *yp;  
5 }  
6  
7 void twiddle2(long *xp, long *yp)  
8 {  
9     *xp += 2* *yp;  
10 }
```

At first glance, both procedures seem to have identical behavior. They both add twice the value stored at the location designated by pointer `yp` to that designated by pointer `xp`. On the other hand, function `twiddle2` is more efficient. It requires only three memory references (read `*xp`, read `*yp`, write `*xp`), whereas `twiddle1` requires six (two reads of `*xp`, two reads of `*yp`, and two writes of `*xp`). Hence, if a compiler is given procedure `twiddle1` to compile, one might think it could generate more efficient code based on the computations performed by `twiddle2`.

Consider, however, the case in which `xp` and `yp` are equal. Then function `twiddle1` will perform the following computations:

```
|  
3      *xp += *xp; /* Double value at xp */  
4      *xp += *xp; /* Double value at xp */
```

The result will be that the value at `xp` will be increased by a factor of 4. On the other hand, function `twiddle2` will perform the following computation:

```
|  
9      *xp += 2* *xp; /* Triple value at xp */
```

The result will be that the value at `xp` will be increased by a factor of 3. The compiler knows nothing about how `twiddle1` will be called, and so it must assume that arguments `xp` and `yp` can be equal. It therefore cannot generate code in the style of `twiddle2` as an optimized version of `twiddle1`.

The case where two pointers may designate the same memory location is known as *memory aliasing*. In performing only safe optimizations, the compiler must assume that different pointers may be aliased. As another example, for a program with pointer variables `p` and `q`, consider the following code sequence:

```
x = 1000; y = 3000;  
*q = y; /* 3000 */  
*p = x; /* 1000 */  
t1 = *q; /* 1000 or 3000 */
```

The value computed for `t1` depends on whether or not pointers `p` and `q` are aliased—if not, it will equal 3,000, but if so it will equal 1,000. This leads to one of the major *optimization blockers*, aspects of programs that can severely limit the opportunities for a compiler to generate optimized code. If a compiler cannot determine whether or not two pointers may be aliased, it must assume that either case is possible, limiting the set of possible optimizations.



# Practice Problem 5.1 (solution page 573)

The following problem illustrates the way memory aliasing can cause unexpected program behavior. Consider the following procedure to swap two values:

```
1      /* Swap value x at xp with value y at yp */
2      void swap(long *xp, long *yp)
3      {
4          *xp = *xp + *yp; /* x+y */
5          *yp = *xp - *yp; /* x+y-y = x */
6          *xp = *xp - *yp; /* x+y-x = y */
7      }
```

If this procedure is called with `xp` equal to `yp`, what effect will it have?

A second optimization blocker is due to function calls. As an example, consider the following two procedures:

```

|
1 long f();
2
3 long func1() {
4     return f ()+ f ()+ f ()+ f ();
5 }
6
7 long func2() {
8     return 4*f();
9 }

```

It might seem at first that both compute the same result, but with `func2` calling `f` only once, whereas `func1` calls it four times. It is tempting to generate code in the style of `func2` when given `func1` as the source.

Consider, however, the following code for `f`:

```

|
1 long counter = 0;
2
3 long f() {
4     return counter++;
5 }

```

This function has a *side effect*—it modifies some part of the global program state. Changing the number of times it gets called changes the program behavior. In

# Aside Optimizing function calls by inline substitution

Code involving function calls can be optimized by a process known as *inline substitution* (or simply "inlining"), where the function call is replaced by the code for the body of the function. For example, we can expand the code for `func1` by substituting four instantiations of function `f`:

```
1      /* Result of inlining f in func1 */
2      long func1in() {
3          long t = counter++; /* +0 */
4          t += counter++; /* +1 */
5          t += counter++; /* +2 */
6          t += counter++; /* +3 */
7          return t;
8      }
```

This transformation both reduces the overhead of the function calls and allows further optimization of the expanded code. For example, the compiler can consolidate the updates of global variable `counter` in `func1` in to generate an optimized version of the function:

```
1      /* Optimization of inlined code */
2      long func1opt() {
3          long t = 4 * counter + 6;
4          counter += 4;
5          return t;
6      }
```

This code faithfully reproduces the behavior of `func1` for this particular definition of function `f`.

Recent versions of `gcc` attempt this form of optimization, either when directed to with the command-line option `-finline` or for optimization level `-O1` and higher.

Unfortunately, `gcc` only attempts inlining for functions defined within a single file. That means it will not be applied in the common case where a set of library functions is defined in one file but invoked by functions in other files.

There are times when it is best to prevent a compiler from performing inline substitution. One is when the code will be evaluated using a symbolic debugger, such as `GDB`, as described in [Section 3.10.2](#). If a function call has been optimized away via inline substitution, then any attempt to trace or set a breakpoint for that call will fail. The second is when evaluating the performance of a program by profiling, as is discussed in [Section 5.14.1](#). Calls to functions that

have been eliminated by inline substitution will not be profiled correctly.

particular, a call to `func1` would return  $0 + 1 + 2 + 3 = 6$ , whereas a call to `func2` would return  $4 \cdot 0 = 0$ , assuming both started with global variable counter set to zero.

Most compilers do not try to determine whether a function is free of side effects and hence is a candidate for optimizations such as those attempted in `func2`. Instead, the compiler assumes the worst case and leaves function calls intact.

Among compilers, `gcc` is considered adequate, but not exceptional, in terms of its optimization capabilities. It performs basic optimizations, but it does not perform the radical transformations on programs that more "aggressive" compilers do. As a consequence, programmers using `gcc` must put more effort into writing programs in a way that simplifies the compiler's task of generating efficient code.

## 5.2 Expressing Program Performance

We introduce the metric *cycles per element*, abbreviated CPE, to express program performance in a way that can guide us in improving the code. CPE measurements help us understand the loop performance of an iterative program at a detailed level. It is appropriate for programs that perform a repetitive computation, such as processing the pixels in an image or computing the elements in a matrix product.

The sequencing of activities by a processor is controlled by a clock providing a regular signal of some frequency, usually expressed in *gigahertz* (GHz), billions of cycles per second. For example, when product literature characterizes a system as a "4 GHz" processor, it means that the processor clock runs at  $4.0 \times 10^9$  cycles per second. The time required for each clock cycle is given by the reciprocal of the clock frequency. These typically are expressed in *nanoseconds* (1 nanosecond is  $10^{-9}$  seconds) or *picoseconds* (1 picosecond is  $10^{-12}$  seconds). For example, the period of a 4 GHz clock can be expressed as either 0.25 nanoseconds or 250 picoseconds. From a programmer's perspective, it is more instructive to express measurements in clock cycles rather than nanoseconds or picoseconds. That way, the measurements express how many instructions are being executed rather than how fast the clock runs.

Many procedures contain a loop that iterates over a set of elements. For example, functions `psum1` and `psum2` in [Figure 5.1](#) both compute the *prefix sum* of a vector of length  $n$ . For a vector  $\vec{a} = \langle a_0, a_1, \dots, a_{n-1} \rangle$ , the prefix sum  $\vec{p} = \langle p_0, p_1, \dots, p_{n-1} \rangle$  is defined as

$$\begin{aligned} p_0 &= a_0 \\ p_i &= p_{i-1} + a_i, \quad 1 < i < n \end{aligned} \tag{5.1}$$

Function `psum1` computes one element of the result vector per iteration. Function `psum2` uses a technique known as *loop unrolling* to compute two elements per iteration. We will explore the benefits of loop unrolling later in this chapter. (See Problems 5.11, 5.12, and 5.19 for more about analyzing and optimizing the prefix-sum computation.)

The time required by such a procedure can be characterized as a constant plus a factor proportional to the number of elements processed. For example, [Figure 5.2](#) shows a plot of the number of clock cycles required by the two functions for a range of values of  $n$ . Using a *least squares fit*, we find that the run times (in clock cycles) for `psum1` and `psum2` can be approximated by the equations  $368 + 9.0n$  and  $368 + 6.0n$ , respectively. These equations indicate an overhead of 368 cycles due to the timing code and to initiate the procedure, set up the loop, and complete the



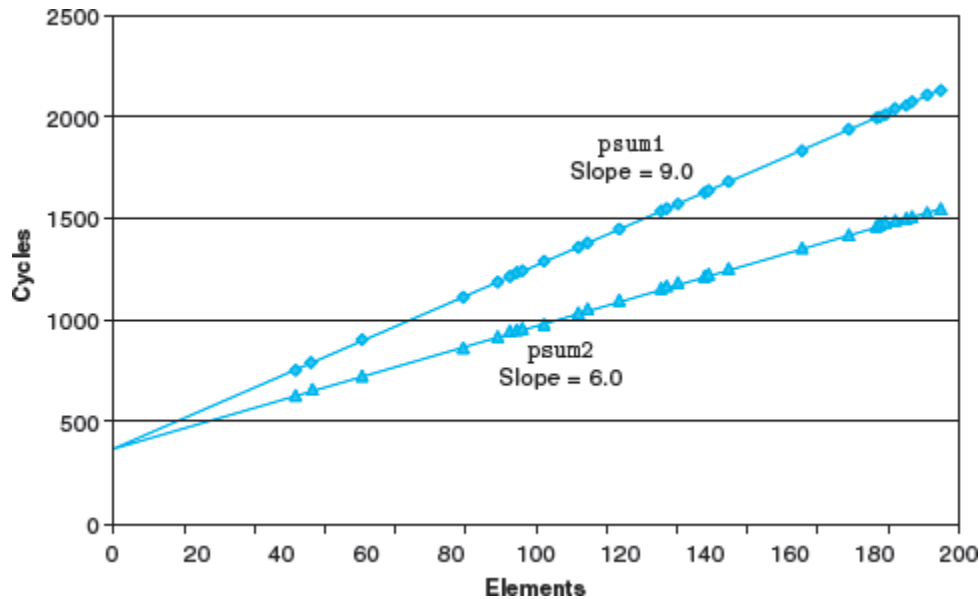
```

1      /* Compute prefix sum of vector a */
2      void pum1(float a[], float p[], long n)
3      {
4          long i;
5          p[0] = a[0];
6          for (i = 1; i < n; i++)
7              p[i] = p[i-1] + a[i];
8      }
9
10     void psum2(float a[], float p[], long n)
11     {
12         long i;
13         p[0] = a[0];
14         for (i = 1; i < n-1; i+=2) {
15             float mid_val = p[i-1] + a[i];
16             p[i] = mid_val;
17             p[i+1] = mid_val + a[i+1];
18         }
19         /* For even n, finish remaining element */
20         if (i < n)
21             p[i] = p[i-1] + a[i];
22     }

```

### Figure 5.1 Prefix-sum functions.

These functions provide examples for how we express program performance.



**Figure 5.2 Performance of prefix-sum functions.**

The slope of the lines indicates the number of clock cycles per element (CPE).

## Aside What is a least squares fit?

For a set of data points  $(x_1, y_1), \dots, (x_n, y_n)$ , we often try to draw a line that best approximates the X-Y trend represented by these data. With a least squares fit, we look for a line of the form  $y = mx + b$  that minimizes the following error measure:

$$E(m, b) = \sum_{i=1, n} (mx_i + b - y_i)^2$$

An algorithm for computing  $m$  and  $b$  can be derived by finding the derivatives of  $E(m, b)$  with respect to  $m$  and  $b$  and setting them to 0.

procedure, plus a linear factor of 6.0 or 9.0 cycles per element. For large values of  $n$  (say, greater than 200), the run times will be dominated by the linear factors. We refer to the coefficients in these terms as the effective number of cycles per element. We prefer measuring the number of cycles per *element* rather than the number of cycles per *iteration*, because techniques such as loop unrolling allow us to use fewer iterations to complete the computation, but our ultimate concern is how fast the procedure will run for a given vector length. We focus our efforts on minimizing the CPE for our computations. By this measure, `psum2`, with a CPE of 6.0, is superior to `psum1`, with a CPE of 9.0.

# Practice Problem 5.2 (solution page **573**)

Later in this chapter we will start with a single function and generate many different variants that preserve the function's behavior, but with different performance characteristics. For three of these variants, we found that the run times (in clock cycles) can be approximated by the following functions:

$$\text{Version 1: } 60 + 35n$$

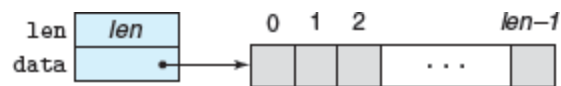
$$\text{Version 2: } 136 + 4n$$

$$\text{Version 3: } 157 + 1.25n$$

For what values of  $n$  would each version be the fastest of the three? Remember that  $n$  will always be an integer.

## 5.3 Program Example

To demonstrate how an abstract program can be systematically transformed into more efficient code, we will use a running example based on the vector data structure shown in [Figure 5.3](#). A vector is represented with two blocks of memory: the header and the data array. The header is a structure declared as follows:



**Figure 5.3 Vector abstract data type.**

A vector is represented by header information plus an array of designated length.

```
|  
-----  
-----code/opt/vec.h  
1      /* Create abstract data type for vector */  
2      typedef struct {  
3          long len;  
4          data_t *data;  
5      } vec_rec, *vec_ptr;  
-----  
-----code/opt/vec.h
```

The declaration uses `data_t` to designate the data type of the underlying elements. In our evaluation, we measured the performance of our code for integer (C `int` and `long`), and floating-point (C `float` and `double`) data. We do this by compiling and running the program separately for different type declarations, such as the following for data type `long`:

```
typedef long data_t;
```

We allocate the data array block to store the vector elements as an array of `len` objects of type `data_t`.

**Figure 5.4** shows some basic procedures for generating vectors, accessing vector elements, and determining the length of a vector. An important feature to note is that `get_vec_element`, the vector access routine, performs bounds checking for every vector reference. This code is similar to the array representations used in many other languages, including Java. Bounds checking reduces the chances of program error, but it can also slow down program execution.

As an optimization example, consider the code shown in **Figure 5.5**, which combines all of the elements in a vector into a single value according to some operation. By using different definitions of compile-time constants `IDENT` and `OP`, the code can be recompiled

to perform different operations on the data. In particular, using the declarations

```
|  
#define IDENT 0  
#define OP +
```

it sums the elements of the vector. Using the declarations

```
|  
#define IDENT 1  
#define OP *
```

it computes the product of the vector elements.

In our presentation, we will proceed through a series of transformations of the code, writing different versions of the combining function. To gauge progress,

```

1      /* Create vector of specified length */
2      vec_ptr new_vec(long len)
3      {
4          /* Allocate header structure */
5          vec_ptr result = (vec_ptr)
malloc(sizeof(vec_rec));
6          data_t *data = NULL;
7          if (!result)
8              return NULL; /* Couldn't allocate
storage */
9          result->len = len;
10         /* Allocate array */
11         if (len > 0) {
12             data = (data_t *)calloc(len,
sizeof(data_t));
13             if (!data) {
14                 free((void *) result);
15                 return NULL; /* Couldn't
allocate storage */
16             }
17         }
18         /* Data will either be NULL or allocated array
*/
19         result->data = data;
20         return result;
21     }
22

```



```

23     /*
24     * Retrieve vector element and store at dest.
25     * Return 0 (out of bounds) or 1 (successful)
26     */
27     int get_vec_element(vec_ptr v, long index, data_t *dest)
28     {
29         if (index < 0 || index >= v->len)
30             return 0;
31         *dest = v->data [index];
32         return 1 ;
33     }
34
35     /* Return length of vector */
36     long vec_length(vec_ptr v)
37     {
38         return v->len;
39     }

```

**Figure 5.4 Implementation of vector abstract data type.**

In the actual program, data type `data_t` is declared to be `int`, `long`, `float`, or `double`.

```

1      /* Implementation with maximum use of data abstraction
*/
2      void combinel(vec_ptr v, data_t *dest)
3      {
4          long i;
5
6          *dest = IDENT;
7          for (i = 0; i < vec_length(v); i++) {
8              data_t val;
9              get_vec_element(v, i, &val);
10             *dest = *dest OP val;
11         }
12     }

```

**Figure 5.5 Initial implementation of combining operation.**

Using different declarations of identity element `IDENT` and combining operation `OP`, we can measure the routine for different operations.

we measured the CPE performance of the functions on a machine with an Intel Core i7 Haswell processor, which we refer to as our *reference machine*. Some characteristics of this processor were given in [Section 3.1](#). These measurements characterize performance in terms of how the programs run on just one particular machine, and so there is no guarantee of comparable performance on other combinations of machine and compiler. However, we have compared the results with those for a number of different

compiler/processor combinations, and we have found them generally consistent with those presented here.

As we proceed through a set of transformations, we will find that many lead to only minimal performance gains, while others have more dramatic effects. Determining which combinations of transformations to apply is indeed part of the "black art" of writing fast code. Some combinations that do not provide measurable benefits are indeed ineffective, while others are important as ways to enable further optimizations by the compiler. In our experience, the best approach involves a combination of experimentation and analysis: repeatedly attempting different approaches, performing measurements, and examining the assembly-code representations to identify underlying performance bottlenecks.

As a starting point, the following table shows CPE measurements for `combine1` running on our reference machine, with different combinations of operation (addition or multiplication) and data type (long integer and double-precision floating-point). Our experiments with many different programs showed that operations on 32-bit and 64-bit integers have identical performance, with the exception of code involving division operations. Similarly, we found identical performance for programs operating on single- or double-precision floating-point data. In our tables, we will therefore show only separate results for integer data and for floating-point data.

We can see that our measurements are somewhat imprecise. The more likely CPE number for integer sum is 23.00, rather than 22.68, while the number for integer product is likely 20.0 instead of 20.02. Rather than "fudging" our numbers to make them look good, we will present the measurements we actually obtained. There are many factors that complicate the task of reliably measuring the precise number of clock cycles required by some code sequence. It helps when examining these numbers to mentally round the results up or down by a few hundredths of a clock cycle.

The unoptimized code provides a direct translation of the C code into machine code, often with obvious inefficiencies. By simply giving the command-line option `-O1`, we enable a basic set of optimizations. As can be seen, this significantly improves the program performance—more than a factor of 2—with no effort on behalf of the programmer. In general, it is good to get into the habit of enabling some level of optimization. (Similar performance results were obtained with optimization level `-Og`.) For the remainder of our measurements, we use optimization levels `-O1` and `-O2` when generating and measuring our programs.

## 5.4 Eliminating Loop Inefficiencies

Observe that procedure `combine1`, as shown in [Figure 5.5](#), calls function `vec_length` as the test condition of the `for` loop. Recall from our discussion of how to translate code containing loops into machine-level programs ([Section 3.6.7](#)) that the test condition must be evaluated on every iteration of the loop. On the other hand, the length of the vector does not change as the loop proceeds. We could therefore compute the vector length only once and use this value in our test condition.

[Figure 5.6](#) shows a modified version called `combine2`. It calls `vec_length` at the beginning and assigns the result to a local variable `length`. This transformation has noticeable effect on the overall performance for some data types and operations, and minimal or even none for others. In any case, this transformation is required to eliminate inefficiencies that would become bottlenecks as we attempt further optimizations.

This optimization is an instance of a general class of optimizations known as *code motion*. They involve identifying a computation that is performed multiple

```
1      /* Move call to vec_length out of loop */
2      void combine2(vec_ptr v, data_t *dest)
3      {
4          long i;
5          long length = vec_length(v);
6
7          *dest = IDENT;
8          for (i = 0; i < length; i++) {
9              data_t val;
10             get_vec_element(v, i, &val);
11             *dest = *dest OP val;
12         }
13     }
```

**Figure 5.6 Improving the efficiency of the loop test.**

By moving the call to `vec_length` out of the loop test, we eliminate the need to execute it on every iteration.

times, (e.g., within a loop), but such that the result of the computation will not change. We can therefore move the computation to an earlier section of the code that does not get

evaluated as often. In this case, we moved the call to `vec_length` from within the loop to just before the loop.

Optimizing compilers attempt to perform code motion. Unfortunately, as discussed previously, they are typically very cautious about making transformations that change where or how many times a procedure is called. They cannot reliably detect whether or not a function will have side effects, and so they assume that it might. For example, if `vec_length` had some side effect, then `combine1` and `combine2` could have different behaviors. To improve the code, the programmer must often help the compiler by explicitly performing code motion.

As an extreme example of the loop inefficiency seen in `combine1`, consider the procedure `lower1` shown in [Figure 5.7](#). This procedure is styled after routines submitted by several students as part of a network programming project. Its purpose is to convert all of the uppercase letters in a string to lowercase. The procedure steps through the string, converting each uppercase character to lowercase. The case conversion involves shifting characters in the range ``A' to `Z'` to the range ``a' to `z'`.

The library function `strlen` is called as part of the loop test of `lower1`. Although `strlen` is typically implemented with special x86 string-processing instructions, its overall execution is similar to the simple version that is also shown in [Figure 5.7](#). Since strings in C are null-terminated character sequences, `strlen` can only determine

the length of a string by stepping through the sequence until it hits a null character. For a string of length  $n$ , `strlen` takes time proportional to  $n$ . Since `strlen` is called in each of the  $n$  iterations of `lower1`, the overall run time of `lower1` is quadratic in the string length, proportional to  $n^2$ .



```

1      /* Convert string to lowercase: slow */
2      void lower1(char *s)
3      {
4          long i;
5
6          for (i = 0; i < strlen(s); i++)
7              if (s[i] >= `A' && s[i] <= `Z')
8                  s[i] -= (`A' - `a');
9      }
10
11     /* Convert string to lowercase: faster */
12     void lower2(char *s)
13     {
14         long i;
15         long len = strlen(s);
16
17         for (i = 0; i < len; i++)
18             if (s[i] >= `A' && s[i] <= `Z')
19                 s[i] -= (`A' - `a');
20     }
21
22     /* Sample implementation of library function strlen */
23     /* Compute length of string */
24     size_t strlen(const char *s)
25     {
26         long length = 0;
27         while (*s != `\\0') {

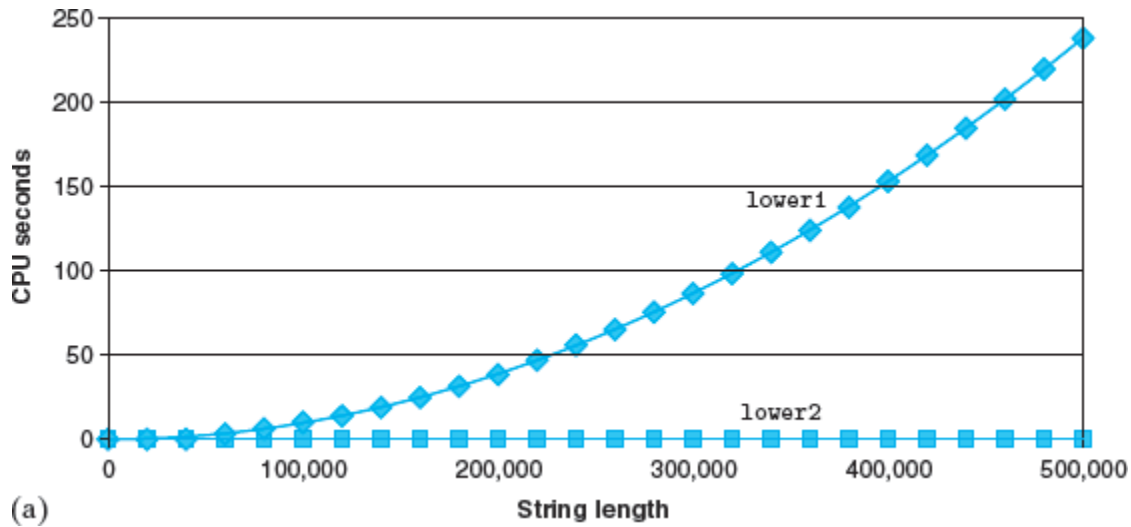
```

```
28         s++;
29         length++;
30     }
31     return length;
32 }
```

### Figure 5.7 Lowercase conversion routines.

The two procedures have radically different performance.

This analysis is confirmed by actual measurements of the functions for different length strings, as shown in [Figure 5.8](#) (and using the library version of `strlen`). The graph of the run time for `lower1` rises steeply as the string length increases ([Figure 5.8\(a\)](#)). [Figure 5.8\(b\)](#) shows the run times for seven different lengths (not the same as shown in the graph), each of which is a power of 2. Observe that for `lower1` each doubling of the string length causes a quadrupling of the run time. This is a clear indicator of a quadratic run time. For a string of length 1,048,576, `lower1` requires over 17 minutes of CPU time.



**Figure 5.8 Comparative performance of lowercase conversion routines.**

The original code `lower1` has a quadratic run time due to an inefficient loop structure. The modified code `lower2` has a linear run time.

Function `lower2` shown in [Figure 5.7](#) is identical to that of `lower1`, except that we have moved the call to `strlen` out of the loop. The performance improves dramatically. For a string length of 1,048,576, the function requires just 2.0 milliseconds—over 500,000 times faster than `lower1`. Each doubling of the string length causes a doubling of the run time—a clear indicator of linear run time. For longer strings, the run-time improvement will be even greater.

In an ideal world, a compiler would recognize that each call to `strlen` in the loop test will return the same result, and thus the call could be moved out of the loop. This would require a very sophisticated analysis, since `strlen` checks the elements of the string and these

values are changing as `lower1` proceeds. The compiler would need to detect that even though the characters within the string are changing, none are being set from nonzero to zero, or vice versa. Such an analysis is well beyond the ability of even the most sophisticated compilers, even if they employ inlining, and so programmers must do such transformations themselves.

This example illustrates a common problem in writing programs, in which a seemingly trivial piece of code has a hidden asymptotic inefficiency. One would not expect a lowercase conversion routine to be a limiting factor in a program's performance. Typically, programs are tested and analyzed on small data sets, for which the performance of `lower1` is adequate. When the program is ultimately deployed, however, it is entirely possible that the procedure could be applied to strings of over one million characters. All of a sudden this benign piece of code has become a major performance bottleneck. By contrast, the performance of `lower2` will be adequate for strings of arbitrary length. Stories abound of major programming projects in which problems of this sort occur. Part of the job of a competent programmer is to avoid ever introducing such asymptotic inefficiency.

# Practice Problem 5.3 (solution page **573**)

Consider the following functions:

```
|  
long min(long x, long y) { return x < y ? x : y; }  
long max(long x, long y) { return x < y ? y : x; }  
void incr(long *xp, long v) { *xp += v; }  
long square(long x) { return x*x; }
```

The following three code fragments call these functions:

A. 

```
for (i = min(x, y); i < max(x, y); incr(&i, 1))  
    t += square(i);
```

B. 

```
for (i = max(x, y) - 1; i >= min(x, y); incr(&i,  
-1))  
    t += square(i);
```


C. `long low = min(x, y);`  
`long high = max(x, y);`

```
for (i = low; i < high; incr(&i, 1))  
    t += square(i);
```

Assume `x` equals 10 and `y` equals 100. Fill in the following table indicating the number of times each of the four functions is called in code fragments A–C:

[OceanofPDF.com](http://OceanofPDF.com)

## 5.5 Reducing Procedure Calls

As we have seen, procedure calls can incur overhead and also block most forms of program optimization. We can see in the code for `combine2` (Figure 5.6 ) that `get_vec_element` is called on every loop iteration to retrieve the next vector element. This function checks the vector index `i` against the loop bounds with every vector reference, a clear source of inefficiency. Bounds checking might be a useful feature when dealing with arbitrary array accesses, but a simple analysis of the code for `combine2` shows that all references will be valid.

---

*code/opt/vec.c*

```
|  
1 data_t *get_vec_start(vec_ptr v)  
2 {  
3     return v->data;  
4 }
```

---

*code/opt/vec.c*

```
|  
1 /* Direct access to vector data */  
2 void combine3(vec_ptr v, data_t *dest)  
3 {  
4     long i;  
5     long length = vec_length(v);  
6     data_t *data = get_vec_start(v);  
7  
8     *dest = IDENT;  
9     for (i = 0; i < length; i++) {  
10         *dest = *dest OP data[i];  
11     }  
12 }
```



### Figure 5.9 Eliminating function calls within the loop.

The resulting code does not show a performance gain, but it enables additional optimizations.

Suppose instead that we add a function `get_vec_start` to our abstract data type. This function returns the starting address of the data array, as shown in [Figure 5.9](#). We could then write the procedure shown as `combine3` in this figure, having no function calls in the inner loop. Rather than making a function call to retrieve each vector element, it accesses the array directly. A purist might say that this transformation seriously impairs the program modularity. In principle, the user of the vector abstract data type should not even need to know that the vector contents are stored as an array, rather than as some other data structure such as a linked list. A more pragmatic programmer would argue that this transformation is a necessary step toward achieving high-performance results.


Surprisingly, there is no apparent performance improvement. Indeed, the performance for integer sum has gotten slightly worse. Evidently, other operations in the inner loop are forming a bottleneck that limits the performance more than the call to `get_vec_element`. We will return to this function later ([Section 5.11.2](#)) and see why the repeated bounds checking by `combine2` does not incur a performance penalty. For now, we can view this transformation as one of a series of steps that will ultimately lead to greatly improved performance.

## 5.6 Eliminating Unneeded Memory References

The code for `combine3` accumulates the value being computed by the combining operation at the location designated by the pointer `dest`. This attribute can be seen by examining the assembly code generated for the inner loop of the compiled code. We show here the x86-64 code generated for data type `double` and with multiplication as the combining operation:

```
|
|
| Inner loop of combine3. data_t = double, OP = *
| dest in %rbx, data+i in %rdx, data+length in %rax
1   .L17:                                loop:
2       vmovsd (%rbx), %xmm0             Read product from dest
3       vmulsd (%rdx), %xmm0, %xmm0     Multiply product by
| data[i]
4       vmovsd %xmm0, (%rbx)            Store product at dest
5       addq $8, %rdx                   Increment data+i
6       cmpq %rax, %rdx                 Compare to data+length
7       jne .L17                        If !=, goto loop
```

We see in this loop code that the address corresponding to pointer `dest` is held in register `%rbx`. It has also transformed the code to maintain a pointer to the  $i$ th data element in register `%rdx`, shown in the annotations as `data+i`. This pointer is incremented by 8 on every iteration. The loop termination is detected by comparing this pointer to one stored in register `%rax`. We can see that the accumulated value is read from and written to memory on each iteration. This reading and writing is wasteful, since the value read from `dest` at the beginning of each iteration should simply be the value written at the end of the previous iteration.

We can eliminate this needless reading and writing of memory by rewriting the code in the style of `combine4` in [Figure 5.10](#) . We introduce a temporary variable `acc` that is used in the loop to accumulate the computed value. The result is stored at `dest` only after the loop has been completed. As the assembly code that follows shows, the compiler can now use register `%xmm0` to hold the accumulated value. Compared to the loop in `combine3`, we have reduced the memory operations per iteration from two reads and one write to just a single read.

```

|
|   Inner loop of combine4. data_t = double, OP = *
|   acc in %xmm0, data+i in %rdx, data+length in %rax
1   .L25:                                loop:
2       vmulsd (%rdx), %xmm0, %xmm0      Multiply acc by
|   data[i]
3       addq $8, %rdx                    Increment data+i
4       cmpq %rax, %rdx                  Compare to data+length
5       jne .L25                          If !=, goto loop

```

We see a significant improvement in program performance, as shown in the following table:

```

1      /* Accumulate result in local variable */
2      void combine4(vec_ptr v, data_t *dest)
3      {
4          long i;
5          long length = vec_length(v);
6          data_t *data = get_vec_start(v);
7          data_t acc = IDENT;
8
9          for (i = 0; i < length; i++) {
10             acc = acc OP data[i];
11         }
12         *dest = acc;
13     }

```

### Figure 5.10 Accumulating result in temporary.

Holding the accumulated value in local variable `acc` (short for "accumulator") eliminates the need to retrieve it from memory and write back the updated value on every loop iteration.

All of our times improve by factors ranging from 2.2× to 5.7×, with the integer addition case dropping to just 1.27 clock cycles per element.

Again, one might think that a compiler should be able to automatically transform the `combine3` code shown in [Figure 5.9](#) to accumulate the value in a register, as it does with the code for

`combine4` shown in [Figure 5.10](#). In fact, however, the two functions can have different behaviors due to memory aliasing. Consider, for example, the case of integer data with multiplication as the operation and 1 as the identity element. Let `v = [2, 3, 5]` be a vector of three elements and consider the following two function calls:

```
combine3(v, get_vec_start(v) + 2);  
combine4(v, get_vec_start(v) + 2);
```

That is, we create an alias between the last element of the vector and the destination for storing the result. The two functions would then execute as follows:

As shown previously, `combine3` accumulates its result at the destination, which in this case is the final vector element. This value is therefore set first to 1, then to  $2 \cdot 1 = 2$ , and then to  $3 \cdot 2 = 6$ . On the last iteration, this value is then multiplied by itself to yield a final value of 36. For the case of `combine4`, the vector remains unchanged until the end, when the final element is set to the computed result  $1 \cdot 2 \cdot 3 \cdot 5 = 30$ .

Of course, our example showing the distinction between `combine3` and `combine4` is highly contrived. One could argue that the behavior of `combine4` more closely matches the intention of the function description. Unfortunately, a compiler cannot make a judgment about

the conditions under which a function might be used and what the programmer's intentions might be. Instead, when given `combine3` to compile, the conservative approach is to keep reading and writing memory, even though this is less efficient.

# Practice Problem 5.4 (solution page 574)

When we use `gcc` to compile `combine3` with command-line option `-O2`, we get code with substantially better CPE performance than with `-O1`:

We achieve performance comparable to that for `combine4`, except for the case of integer sum, but even it improves significantly. On examining the assembly code generated by the compiler, we find an interesting variant for the inner loop:

```
|
| Inner loop of combine3. data_t = double, OP = *.
| Compiled -O2
| dest in %rbx, data+i in %rdx, data+length in %rax
| Accumulated product in %xmm0
1   .L22:                                loop:
2   vmulsd (%rdx), %xmm0, %xmm0          Multiply product
| by data[i]
3   addq $8, %rdx                         Increment data+i
4   cmpq %rax, %rdx                       Compare to
| data+length
5   vmovsd %xmm0, (%rbx)                  Store product at
| dest
6   jne .L22                              If !=, goto loop
```



We can compare this to the version created with optimization level 1:

```
|
|
|   Inner loop of combine3. data_t = double, OP = *.
| Compiled -O1
|   dest in %rbx, data+i in %rdx, data+length in %rax
1   .L17:                                loop:
2       vmovsd (%rbx), %xmm0              Read product
|   from dest
3       vmulsd (%rdx), %xmm0, %xmm0      Multiply
|   product by data[i]
4       vmovsd %xmm0, (%rbx)              Store product
|   at dest
5       addq $8, %rdx                     Increment
|   data+i
6       cmpq %rax, %rdx                   Compare to
|   data+length
7       jne .L17                           If !=, goto
|   loop
```

We see that, besides some reordering of instructions, the only difference is that the more optimized version does not contain the `vmovsd` implementing the read from the location designated by `dest` (line 2).

- A. How does the role of register `%xmm0` differ in these two loops?

- B. Will the more optimized version faithfully implement the C code of `combine3`, including when there is memory aliasing between `dest` and the vector data?
- C. Either explain why this optimization preserves the desired behavior, or give an example where it would produce different results than the less optimized code.

With this final transformation, we reached a point where we require just 1.25-5 clock cycles for each element to be computed. This is a considerable improvement over the original 9-11 cycles when we first enabled optimization. We would now like to see just what factors are constraining the performance of our code and how we can improve things even further.

[OceanofPDF.com](http://OceanofPDF.com)

## 5.7 Understanding Modern Processors



Up to this point, we have applied optimizations that did not rely on any features of the target machine. They simply reduced the overhead of procedure calls and eliminated some of the critical "optimization blockers" that cause difficulties for optimizing compilers. As we seek to push the performance further, we must consider optimizations that exploit the *microarchitecture* of the processor—that is, the underlying system design by which a processor executes instructions. Getting every last bit of performance requires a detailed analysis of the program as well as code generation tuned for the target processor. Nonetheless, we can apply some basic optimizations that will yield an overall performance improvement on a large class of processors. The detailed performance results we report here may not hold for other machines, but the general principles of operation and optimization apply to a wide variety of machines.

To understand ways to improve performance, we require a basic understanding of the microarchitectures of modern processors. Due to the large number of transistors that can be integrated onto a single chip, modern microprocessors employ complex hardware that attempts to maximize program performance. One result is that their actual operation is far different from the view that is perceived by

looking at machine-level programs. At the code level, it appears as if instructions are executed one at a time, where each instruction involves fetching values from registers or memory, performing an operation, and storing results back to a register or memory location. In the actual processor, a number of instructions are evaluated simultaneously, a phenomenon referred to as *instruction-level parallelism*. In some designs, there can be 100 or more instructions "in flight." Elaborate mechanisms are employed to make sure the behavior of this parallel execution exactly captures the sequential semantic model required by the machine-level program. This is one of the remarkable feats of modern microprocessors: they employ complex and exotic microarchitectures, in which multiple instructions can be executed in parallel, while presenting an operational view of simple sequential instruction execution.

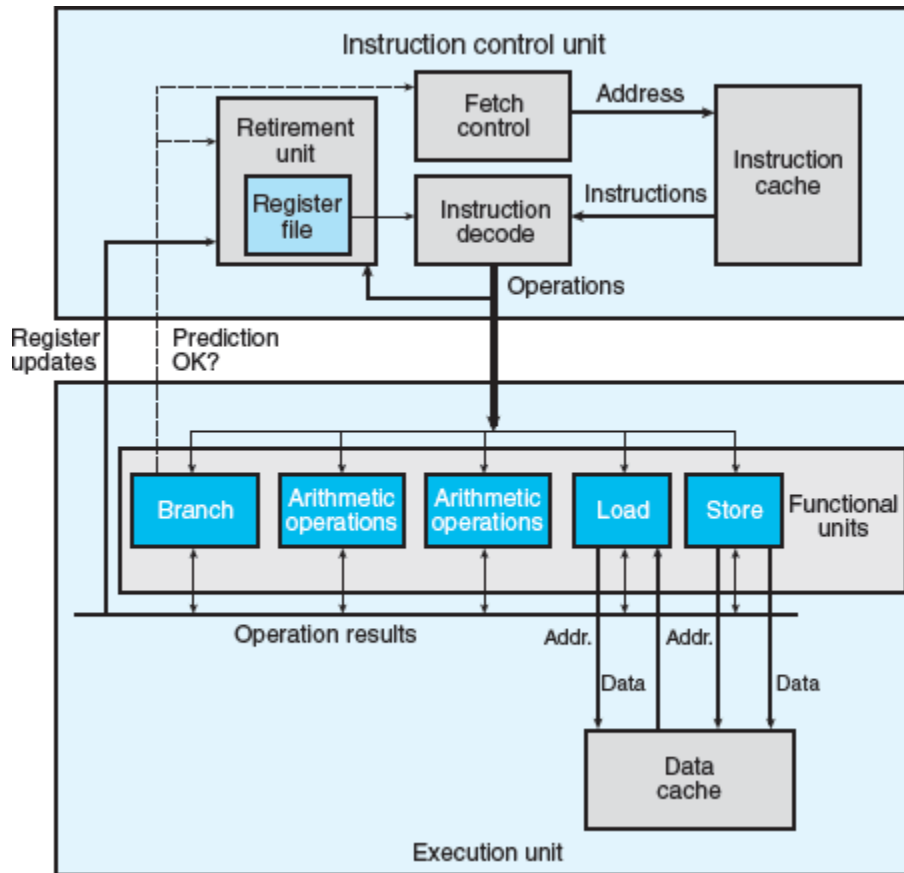
Although the detailed design of a modern microprocessor is well beyond the scope of this book, having a general idea of the principles by which they operate suffices to understand how they achieve instruction-level parallelism. We will find that two different lower bounds characterize the maximum performance of a program. The *latency bound* is encountered when a series of operations must be performed in strict sequence, because the result of one operation is required before the next one can begin. This bound can limit program performance when the data dependencies in the code limit the ability of the processor to exploit instruction-level parallelism. The *throughput bound* characterizes the raw computing capacity of the processor's functional units. This bound becomes the ultimate limit on program performance.

## 5.7.1 Overall Operation

**Figure 5.11**  shows a very simplified view of a modern microprocessor. Our hypothetical processor design is based loosely on the structure of recent Intel processors. These processors are described in the industry as being *superscalar*, which means they can perform multiple operations on every clock cycle and *out of order*, meaning that the order in which instructions execute need not correspond to their ordering in the machine-level program. The overall design has two main parts: the *instruction control unit* (ICU), which is responsible for reading a sequence of instructions from memory and generating from these a set of primitive operations to perform on program data, and the *execution unit* (EU), which then executes these operations. Compared to the simple *in-order* pipeline we studied in **Chapter 4** , out-of-order processors require far greater and more complex hardware, but they are better at achieving higher degrees of instruction-level parallelism.

The ICU reads the instructions from an *instruction cache*—a special high-speed memory containing the most recently accessed instructions. In general, the ICU fetches well ahead of the currently executing instructions, so that it has enough time to decode these and send operations down to the EU. One problem, however, is that when a program hits a branch,<sup>1</sup> there are two possible directions the program might go. The branch can be *taken*, with control passing to the branch target. Alternatively, the branch can be *not taken*, with control passing to the next

1. We use the term "branch" specifically to refer to conditional jump instructions. Other instructions that can transfer control to multiple destinations, such as procedure return and indirect jumps, provide similar challenges for the processor.



**Figure 5.11 Block diagram of an out-of-order processor.**

The instruction control unit is responsible for reading instructions from memory and generating a sequence of primitive operations. The execution unit then performs the operations and indicates whether the branches were correctly predicted.

instruction in the instruction sequence. Modern processors employ a technique known as *branch prediction*, in which they guess whether or not a branch will be taken and also predict the target address for the branch. Using a technique known as *speculative execution*, the

processor begins fetching and decoding instructions at where it predicts the branch will go, and even begins executing these operations before it has been determined whether or not the branch prediction was correct. If it later determines that the branch was predicted incorrectly, it resets the state to that at the branch point and begins fetching and executing instructions in the other direction. The block labeled "Fetch control" incorporates branch prediction to perform the task of determining which instructions to fetch.

The *instruction decoding* logic takes the actual program instructions and converts them into a set of primitive *operations* (sometimes referred to as *micro-operations*). Each of these operations performs some simple computational task such as adding two numbers, reading data from memory, or writing data to memory. For machines with complex instructions, such as x86 processors, an instruction can be decoded into multiple operations. The details of how instructions are decoded into sequences of operations varies between machines, and this information is considered highly proprietary. Fortunately, we can optimize our programs without knowing the low-level details of a particular machine implementation.

In a typical x86 implementation, an instruction that only operates on registers, such as

```
addq %rax,%rdx
```

is converted into a single operation. On the other hand, an instruction involving one or more memory references, such as

```
addq %rax, 8(%rdx)
```

yields multiple operations, separating the memory references from the arithmetic operations. This particular instruction would be decoded as three operations: one to *load* a value from memory into the processor, one to add the loaded value to the value in register `%eax`, and one to *store* the result back to memory. The decoding splits instructions to allow a division of labor among a set of dedicated hardware units. These units can then execute the different parts of multiple instructions in parallel.

The EU receives operations from the instruction fetch unit. Typically, it can receive a number of them on each clock cycle. These operations are dispatched to a set of *functional units* that perform the actual operations. These functional units are specialized to handle different types of operations.

Reading and writing memory is implemented by the load and store units. The load unit handles operations that read data from the memory into the processor. This unit has an adder to perform address computations. Similarly, the store unit handles operations that write data from the processor to the memory. It also has an adder to perform address computations. As shown in the figure, the



load and store units access memory via a *data cache*, a high-speed memory containing the most recently accessed data values.


With speculative execution, the operations are evaluated, but the final results are not stored in the program registers or data memory until the processor can be certain that these instructions should actually have been executed. Branch operations are sent to the EU, not to determine where the branch should go, but rather to determine whether or not they were predicted correctly. If the prediction was incorrect, the EU will discard the results that have been computed beyond the branch point. It will also signal the branch unit that the prediction was incorrect and indicate the correct branch destination. In this case, the branch unit begins fetching at the new location. As we saw in [Section 3.6.6](#), such a *misprediction* incurs a significant cost in performance. It takes a while before the new instructions can be fetched, decoded, and sent to the functional units.

[Figure 5.11](#) indicates that the different functional units are designed to perform different operations. Those labeled as performing "arithmetic operations" are typically specialized to perform different combinations of integer and floating-point operations. As the number of transistors that can be integrated onto a single microprocessor chip has grown over time, successive models of microprocessors have increased the total number of functional units, the combinations of operations each unit can perform, and the performance of each of these units. The arithmetic units are intentionally designed to be able to perform a variety of different operations, since the required operations vary widely across

different programs. For example, some programs might involve many integer operations, while others require many floating-point operations. If one functional unit were specialized to perform integer operations while another could only perform floating-point operations, then none of these programs would get the full benefit of having multiple functional units.

For example, our Intel Core i7 Haswell reference machine has eight functional units, numbered 0–7. Here is a partial list of each one's capabilities:

0. Integer arithmetic, floating-point multiplication, integer and floating-point division, branches
1. Integer arithmetic, floating-point addition, integer multiplication, floating-point multiplication
2. Load, address computation
3. Load, address computation
4. Store
5. Integer arithmetic
6. Integer arithmetic, branches
7. Store address computation

In the above list, "integer arithmetic" refers to basic operations, such as addition, bitwise operations, and shifting. Multiplication and division require more specialized resources. We see that a store operation requires two functional units—one to compute the store address and one to actually store the data. We will discuss the mechanics of store (and load) operations in [Section 5.12](#) .

We can see that this combination of functional units has the potential to perform multiple operations of the same type simultaneously. It has four units capable of performing integer operations, two that can perform load operations, and two that can perform floating-point multiplication. We will later see the impact these resources have on the maximum performance our programs can achieve.

Within the ICU, the *retirement unit* keeps track of the ongoing processing and makes sure that it obeys the sequential semantics of the machine-level program. Our figure shows a *register file* containing the integer, floating-point, and, more recently, SSE and AVX registers as part of the retirement unit, because this unit controls the updating of these registers. As an instruction is decoded, information about it is placed into a first-in, first-out queue. This information remains in the queue until one of two outcomes occurs. First, once the operations for the instruction have completed and any branch points leading to this instruction are confirmed as having been correctly predicted, the instruction can be *retired*, with any updates to the program registers being made. If some branch point leading to this instruction was mispredicted, on the other hand, the instruction will be


# Aside The history of out-of-order processing

Out-of-order processing was first implemented in the Control Data Corporation 6600 processor in 1964. Instructions were processed by 10 different functional units, each of which could be operated independently. In its day, this machine, with a clock rate of 10 MHz, was considered the premium machine for scientific computing.

IBM first implemented out-of-order processing with the IBM 360/91 processor in 1966, but just to execute the floating-point instructions. For around 25 years, out-of-order processing was considered an exotic technology, found only in machines striving for the highest possible performance, until IBM reintroduced it in the RS/6000 line of workstations in 1990. This design became the basis for the IBM/Motorola PowerPC line, with the model 601, introduced in 1993, becoming the first single-chip microprocessor to use out-of-order processing. Intel introduced out-of-order processing with its PentiumPro model in 1995, with an underlying microarchitecture similar to that of our reference machine.

*flushed*, discarding any results that may have been computed. By this means, mispredictions will not alter the program state.

As we have described, any updates to the program registers occur only as instructions are being retired, and this takes place only after the processor can be certain that any branches leading to this

instruction have been correctly predicted. To expedite the communication of results from one instruction to another, much of this information is exchanged among the execution units, shown in the figure as "Operation results." As the arrows in the figure show, the execution units can send results directly to each other. This is a more elaborate form of the data-forwarding techniques we incorporated into our simple processor design in [Section 4.5.5](#) .


The most common mechanism for controlling the communication of operands among the execution units is called *register renaming*. When an instruction that updates register  $r$  is decoded, a *tag*  $t$  is generated giving a unique identifier to the result of the operation. An entry  $(r, t)$  is added to a table maintaining the association between program register  $r$  and tag  $t$  for an operation that will update this register. When a subsequent instruction using register  $r$  as an operand is decoded, the operation sent to the execution unit will contain  $t$  as the source for the operand value. When some execution unit completes the first operation, it generates a result  $(v, t)$ , indicating that the operation with tag  $t$  produced value  $v$ . Any operation waiting for  $t$  as a source will then use  $v$  as the source value, a form of data forwarding. By this mechanism, values can be forwarded directly from one operation to another, rather than being written to and read from the register file, enabling the second operation to begin as soon as the first has completed. The renaming table only contains entries for registers having pending write operations. When a decoded instruction requires a register  $r$ , and there is no tag associated with this register, the operand is retrieved directly from the register file. With register renaming, an entire

sequence of operations can be performed speculatively, even though the registers are updated only after the processor is certain of the branch outcomes.

**Figure 5.12 Latency, issue time, and capacity characteristics of reference machine operations.**

Latency indicates the total number of clock cycles required to perform the actual operations, while issue time indicates the minimum number of cycles between two independent operations. The capacity indicates how many of these operations can be issued simultaneously. The times for division depend on the data values.

## 5.7.2 Functional Unit Performance

**Figure 5.12**  documents the performance of some of the arithmetic operations for our Intel Core i7 Haswell reference machine, determined by both measurements and by reference to Intel literature [49]. These timings are typical for other processors as well. Each operation is characterized by its *latency*, meaning the total time required to perform the operation, the *issue time*, meaning the minimum number of clock cycles between two independent operations of the same type, and the *capacity*, indicating the number of functional units capable of performing that operation.

We see that the latencies increase in going from integer to floating-point operations. We see also that the addition and multiplication operations all have issue times of 1, meaning that on each clock cycle, the processor can start a new one of these operations. This short issue time is achieved through the use of *pipelining*. A pipelined function unit is implemented as a series of *stages*, each of which performs part of the operation. For example, a typical floating-point adder contains three stages (and hence the three-cycle latency): one to process the exponent values, one to add the fractions, and one to round the result. The arithmetic operations can proceed through the stages in close succession rather than waiting for one operation to complete before the next begins. This capability can be exploited only if there are successive, logically independent operations to be performed. Functional units with issue times of 1 cycle are said to be *fully pipelined*: they can start a new operation


every clock cycle. Operations with capacity greater than 1 arise due to the capabilities of the multiple functional units, as was described earlier for the reference machine.

We see also that the divider (used for integer and floating-point division, as well as floating-point square root) is not pipelined—its issue time equals its latency. What this means is that the divider must perform a complete division before it can begin anew one. We also see that the latencies and issue times for division are given as ranges, because some combinations of dividend and divisor require more steps than others. The long latency and issue times of division make it a comparatively costly operation.

A more common way of expressing issue time is to specify the maximum *throughput* of the unit, defined as the reciprocal of the issue time. A fully pipelined functional unit has a maximum throughput of 1 operation per clock cycle, while units with higher issue times have lower maximum throughput. Having multiple functional units can increase throughput even further. For an operation with capacity  $C$  and issue time  $I$ , the processor can potentially achieve a throughput of  $C/I$  operations per clock cycle. For example, our reference machine is capable of performing floating-point multiplication operations at a rate of 2 per clock cycle. We will see how this capability can be exploited to increase program performance.

Circuit designers can create functional units with wide ranges of performance characteristics. Creating a unit with short latency or



with pipelining requires more hardware, especially for more complex functions such as multiplication and floating-point operations. Since there is only a limited amount of space for these units on the microprocessor chip, CPU designers must carefully balance the number of functional units and their individual performance to achieve optimal overall performance. They evaluate many different benchmark programs and dedicate the most resources to the most critical operations. As [Figure 5.12](#)  indicates, integer multiplication and floating-point multiplication and addition were considered important operations in the design of the Core i7 Haswell processor, even though a significant amount of hardware is required to achieve the low latencies and high degree of pipelining shown. On the other hand, division is relatively infrequent and difficult to implement with either short latency or full pipelining.

The latencies, issue times, and capacities of these arithmetic operations can affect the performance of our combining functions. We can express these effects in terms of two fundamental bounds on the CPE values:

The *latency bound* gives a minimum value for the CPE for any function that must perform the combining operation in a strict sequence. The *throughput bound* gives a minimum bound for the CPE based on the maximum rate at which the functional units can produce results. For example, since there is only one integer multiplier, and it has an issue time of 1 clock cycle, the processor cannot possibly sustain a rate of more than 1 multiplication per clock cycle. On the other hand, with four functional units capable of

performing integer addition, the processor can potentially sustain a rate of 4 operations per cycle. Unfortunately, the need to read elements from memory creates an additional throughput bound. The two load units limit the processor to reading at most 2 data values per clock cycle, yielding a throughput bound of 0.50. We will demonstrate the effect of both the latency and throughput bounds with different versions of the combining functions.

## 5.7.3 An Abstract Model of Processor Operation

As a tool for analyzing the performance of a machine-level program executing on a modern processor, we will use a *data-flow* representation of programs, a graphical notation showing how the data dependencies between the different operations constrain the order in which they are executed. These constraints then lead to *critical paths* in the graph, putting a lower bound on the number of clock cycles required to execute a set of machine instructions.

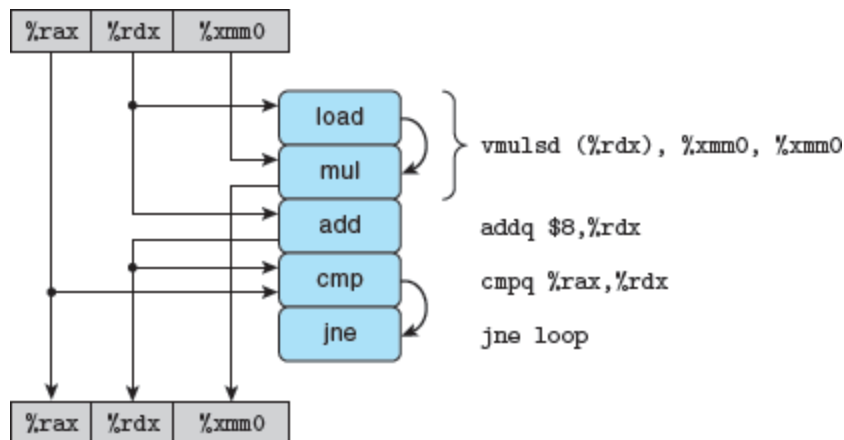
Before proceeding with the technical details, it is instructive to examine the CPE measurements obtained for function `combine4`, our fastest code up to this point:

We can see that these measurements match the latency bound for the processor, except for the case of integer addition. This is not a coincidence—it indicates that the performance of these functions is dictated by the latency of the sum or product computation being performed. Computing the product or sum of  $n$  elements requires around  $L \cdot n + K$  clock cycles, where  $L$  is the latency of the combining operation and  $K$  represents the overhead of calling the function and initiating and terminating the loop. The CPE is therefore equal to the latency bound  $L$ .

# From Machine-Level Code to Data-Flow Graphs

Our data-flow representation of programs is informal. We use it as a way to visualize how the data dependencies in a program dictate its performance. We present the data-flow notation by working with `combine4` (Figure 5.10) as an example. We focus just on the computation performed by the loop, since this is the dominating factor in performance for large vectors. We consider the case of data type `double` with multiplication as the combining operation. Other combinations of data type and operation yield similar code. The compiled code for this loop consists of four instructions, with registers `%rdx` holding a pointer to the  $i$ th element of array `data`, `%rax` holding a pointer to the end of the array, and `%xmm0` holding the accumulated value `acc`.

```
|  
|  
| Inner loop of combine4. data_t = double, OP = *  
| acc in %xmm0, data+i in %rdx, data+length in %rax  
1 .L25: loop:  
2 vmulsd (%rdx), %xmm0, %xmm0 Multiply acc by  
data[i]  
3 addq $8, %rdx Increment data+i  
4 cmpq %rax, %rdx Compare to data+length  
5 jne .L25 If !=, goto loop
```



**Figure 5.13** Graphical representation of inner-loop code for


`combine4`

Instructions are dynamically translated into one or two operations, each of which receives values from other operations or from registers and produces values for other operations and for registers. We show the target of the final instruction as the label `loop`. It jumps to the first instruction shown.

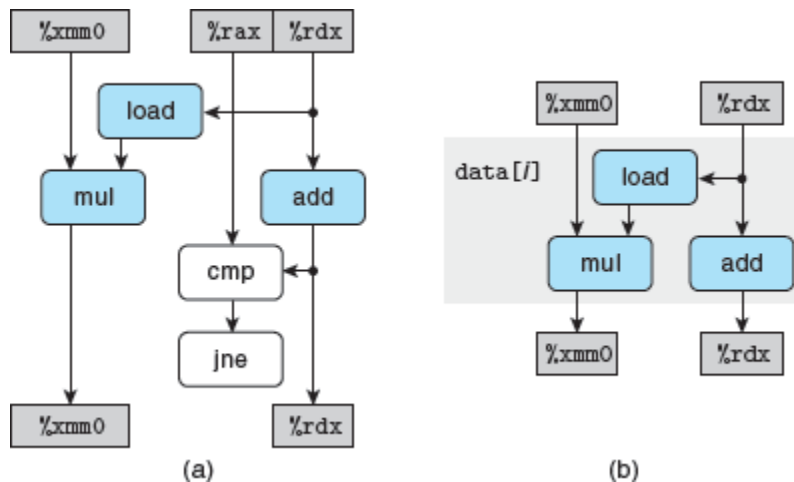
As [Figure 5.13](#) indicates, with our hypothetical processor design, the four instructions are expanded by the instruction decoder into a series of five *operations*, with the initial multiplication instruction being expanded into a load operation to read the source operand from memory, and a `mul` operation to perform the multiplication.

As a step toward generating a data-flow graph representation of the program, the boxes and lines along the left-hand side of [Figure 5.13](#) show how the registers are used and updated by the different operations, with the boxes along the top representing the register values at the beginning of the loop, and those along the bottom representing the values at the end. For example, register `%rax` is

only used as a source value by the `cmp` operation, and so the register has the same value at the end of the loop as at the beginning. Register `%rdx`, on the other hand, is both used and updated within the loop. Its initial value is used by the load and add operations; its new value is generated by the add operation, which is then used by the `cmp` operation. Register `%xmm0` is also updated within the loop by the `mul` operation, which first uses the initial value as a source value.

Some of the operations in [Figure 5.13](#)  produce values that do not correspond to registers. We show these as arcs between operations on the right-hand side. The load operation reads a value from memory and passes it directly to the `mul` operation. Since these two operations arise from decoding a single `vmulsd` instruction, there is no register associated with the intermediate value passing between them. The `cmp` operation updates the condition codes, and these are then tested by the `jne` operation.

For a code segment forming a loop, we can classify the registers that are accessed into four categories:



**Figure 5.14** Abstracting `combine4` operations as a data-flow graph.

We rearrange the operators of [Figure 5.13](#) to more clearly show the data dependencies (a), and then further show only those operations that use values from one iteration to produce new values for the next (b).




**Read-only.** These are used as source values, either as data or to compute memory addresses, but they are not modified within the loop. The only read only register for the loop in `combine4` is `%rax`.


**Write-only.** These are used as the destinations of data-movement operations. There are no such registers in this loop.


**Local.** These are updated and used within the loop, but there is no dependency from one iteration to another. The condition code registers are examples for this loop: they are updated by the `cmp` operation and used by the `jne` operation, but this dependency is contained within individual iterations.

**Loop.** These are used both as source values and as destinations for the loop, with the value generated in one iteration being used in another. We can see that `%rdx` and `%xmm0` are loop registers for `combine4`, corresponding to program values `data+i` and `acc`.

As we will see, the chains of operations between loop registers determine the performance-limiting data dependencies.



**Figure 5.14**  shows further refinements of the graphical representation of **Figure 5.13** , with a goal of showing only those operations and data dependencies that affect the program execution time. We see in **Figure 5.14(a)**  that we rearranged the operators to show more clearly the flow of data from the source registers at the top (both read-only and loop registers) and to the destination registers at the bottom (both write-only and loop registers).

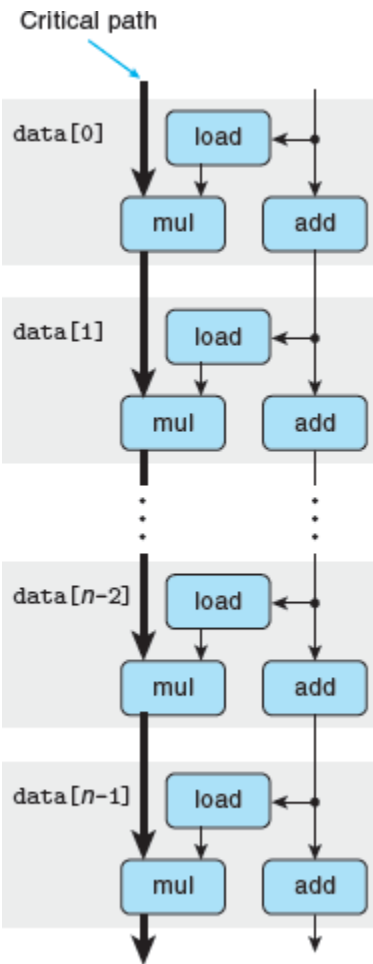
In **Figure 5.14(a)** , we also color operators white if they are not part of some chain of dependencies between loop registers. For this example, the comparison (`cmp`) and branch (`jne`) operations do not directly affect the flow of data in the program. We assume that the instruction control unit predicts that branch will be taken, and hence the program will continue looping. The purpose of the compare and branch operations is to test the branch condition and notify the ICU if it is not taken. We assume this checking can be done quickly enough that it does not slow down the processor.

In **Figure 5.14(b)** , we have eliminated the operators that were colored white on the left, and we have retained only the loop



registers. What we have left is an abstract template showing the data dependencies that form among loop registers due to one iteration of the loop. We can see in this diagram that there are two data dependencies from one iteration to the next. Along one side, we see the dependencies between successive values of program value `acc`, stored in register `%xmm0`. The loop computes a new value for `acc` by multiplying the old value by a data element, generated by the load operation. Along the other side, we see the dependencies between successive values of the pointer to the  $i$ th data element. On each iteration, the old value is used as the address for the load operation, and it is also incremented by the add operation to compute its new value.

**Figure 5.15**  shows the data-flow representation of  $n$  iterations by the inner loop of function `combine4`. This graph was obtained by simply replicating the template shown in **Figure 5.14(b)**   $n$  times. We can see that the program has two chains of data





**Figure 5.15** Data-flow representation of computation by  $n$  iterations of the inner loop of `combine4`.

The sequence of multiplication operations forms a critical path that limits program performance.

dependencies, corresponding to the updating of program values `acc` and `data+i` with operations `mul` and `add`, respectively. Given that floating-point multiplication has a latency of 5 cycles, while integer addition has a latency of 1 cycle, we can see that the chain on the left will form a *critical path*, requiring  $5n$  cycles to execute. The chain

on the right would require only  $n$  cycles to execute, and so it does not limit the program performance.

**Figure 5.15**  demonstrates why we achieved a CPE equal to the latency bound of 5 cycles for `combine4`, when performing floating-point multiplication. When executing the function, the floating-point multiplier becomes the limiting resource. The other operations required during the loop—manipulating and testing pointer value `data+i` and reading data from memory—proceed in parallel with the multiplication. As each successive value of `acc` is computed, it is fed back around to compute the next value, but this will not occur until 5 cycles later.

The flow for other combinations of data type and operation are identical to those shown in **Figure 5.15** , but with a different data operation forming the chain of data dependencies shown on the left. For all of the cases where the operation has a latency  $L$  greater than 1, we see that the measured CPE is simply  $L$ , indicating that this chain forms the performance-limiting critical path.

## Other Performance Factors

For the case of integer addition, on the other hand, our measurements of `combine4` show a CPE of 1.27, slower than the CPE of 1.00 we would predict based on the chains of dependencies formed along either the left- or the right-hand side of the graph of [Figure 5.15](#). This illustrates the principle that the critical paths in a data-flow representation provide only a *lower* bound on how many cycles a program will require. Other factors can also limit performance, including the total number of functional units available and the number of data values that can be passed among the functional units on any given step. For the case of integer addition as the combining operation, the data operation is sufficiently fast that the rest of the operations cannot supply data fast enough. Determining exactly why the program requires 1.27 cycles per element would require a much more detailed knowledge of the hardware design than is publicly available.

To summarize our performance analysis of `combine4`: our abstract data-flow representation of program operation showed that `combine4` has a critical path of length  $L \cdot n$  caused by the successive updating of program value `acc`, and this path limits the CPE to at least  $L$ . This is indeed the CPE we measure for all cases except integer addition, which has a measured CPE of 1.27 rather than the CPE of 1.00 we would expect from the critical path length.

It may seem that the latency bound forms a fundamental limit on how fast our combining operations can be performed. Our next task will

be to restructure the operations to enhance instruction-level parallelism. We want to transform the program in such a way that our only limitation becomes the throughput bound, yielding CPEs below or close to 1.00.

## Practice Problem 5.5 (solution page [575](#))

Suppose we wish to write a function to evaluate a polynomial, where a polynomial of degree  $n$  is defined to have a set of coefficients  $a_0, a_1, a_2, \dots, a_n$ . For a value  $x$ , we evaluate the polynomial by computing

$$a_0 + a_1x + a_2x^2 + \dots + a_nx^n \quad (5.2)$$

This evaluation can be implemented by the following function, having as arguments an array of coefficients `a`, a value `x`, and the polynomial degree `degree` (the value  $n$  in Equation 5.2). In this function, we compute both the successive terms of the equation and the successive powers of  $x$  within a single loop:

```
1 double poly(double a[], double x, long degree)
2 {
3     long i;
4     double result = a[0];
5     double xpwr = x; /* Equals  $x_i$  at start of
loop */
6     for (i = 1; i <= degree; i++) {
7         result += a[i] * xpwr;
8         xpwr = x * xpwr;
9     }
10    return result;
11 }
```

- A. For degree  $n$ , how many additions and how many multiplications does this code perform?
- B. On our reference machine, with arithmetic operations having the latencies shown in [Figure 5.12](#), we measure the CPE for this function to be 5.00. Explain how this CPE arises based on the data dependencies formed between iterations due to the operations implementing lines 7-8 of the function.

## Practice Problem 5.6 (solution page [575](#))

Let us continue exploring ways to evaluate polynomials, as described in [Practice Problem 5.5](#). We can reduce the number of multiplications in evaluating a polynomial by applying *Horner's method*, named after British mathematician William G. Horner (1786-1837). The idea is to repeatedly factor out the powers of  $x$  to get the following evaluation:



$$a_0 + x (a_1 + x (a_2 + \dots + x (a_{n-1} + x a_n) \dots)) \quad (5.3)$$

Using Horner's method, we can implement polynomial evaluation using the following code:

```
|
1      /* Apply Horner's method */
2      double polyh(double a[], double x, long degree)
3      {
4          long i;
5          double result = a[degree];
6          for (i = degree-1; i >= 0; i-)
7              result = a[i] + x*result;
8          return result;
9      }
```

- A. For degree  $n$ , how many additions and how many multiplications does this code perform?



- B. On our reference machine, with the arithmetic operations having the latencies shown in **Figure 5.12** , we measure the CPE for this function to be 8.00. Explain how this CPE arises based on the data dependencies formed between iterations due to the operations implementing line 7 of the function.
- C. Explain how the function shown in **Practice Problem 5.5**  can run faster, even though it requires more operations.

[OceanofPDF.com](http://OceanofPDF.com)

## 5.8 Loop Unrolling

Loop unrolling is a program transformation that reduces the number of iterations for a loop by increasing the number of elements computed on each iteration. We saw an example of this with the function `psum2` (Figure 5.1), where each iteration computes two elements of the prefix sum, thereby halving the total number of iterations required. Loop unrolling can improve performance in two ways. First, it reduces the number of operations that do not contribute directly to the program result, such as loop indexing and conditional branching. Second, it exposes ways in which we can further transform the code to reduce the number of operations in the critical paths of the overall computation. In this section, we will examine simple loop unrolling, without any further transformations.

Figure 5.16 shows a version of our combining code using what we will refer to as "2 × 1 loop unrolling." The first loop steps through the array two elements at a time. That is, the loop index `i` is incremented by 2 on each iteration, and the combining operation is applied to array elements `i` and `i + 1` in a single iteration.

In general, the vector length will not be a multiple of 2. We want our code to work correctly for arbitrary vector lengths. We account for this requirement in two ways. First, we make sure the first loop does not overrun the array bounds. For a vector of length  $n$ , we set the loop limit to be  $n - 1$ . We are then assured that the loop will only be

executed when the loop index  $i$  satisfies  $i < n - 1$ , and hence the maximum array index  $i + 1$  will satisfy  $i + 1 < (n - 1) + 1 = n$ .

We can generalize this idea to unroll a loop by any factor  $k$ , yielding  $k \times 1$  loop unrolling. To do so, we set the upper limit to be  $n - k + 1$  and within the loop apply the combining operation to elements  $i$  through  $i + k - 1$ . Loop index `i` is incremented by  $k$  in each iteration. The maximum array index  $i + k - 1$  will then be less than  $n$ . We include the second loop to step through the final few elements of the vector one at a time. The body of this loop will be executed between 0 and  $k - 1$  times. For  $k = 2$ , we could use a simple conditional statement

```

1      /* 2 x 1 loop unrolling */
2      void combine5(vec_ptr v, data_t *dest)
3      {
4          long i;
5          long length = vec_length(v);
6          long limit = length-1;
7          data_t *data = get_vec_start(v);
8          data_t acc = IDENT;
9
10         /* Combine 2 elements at a time */
11         for (i = 0; i < limit; i+=2) {
12             acc = (acc OP data[i]) OP data[i+1];
13         }
14
15         /* Finish any remaining elements */
16         for (;i < length; i++) {
17             acc = acc OP data[i];
18         }
19         *dest = acc;
20     }

```

**Figure 5.16 Applying  $2 \times 1$  loop unrolling.**

This transformation can reduce the effect of loop overhead.

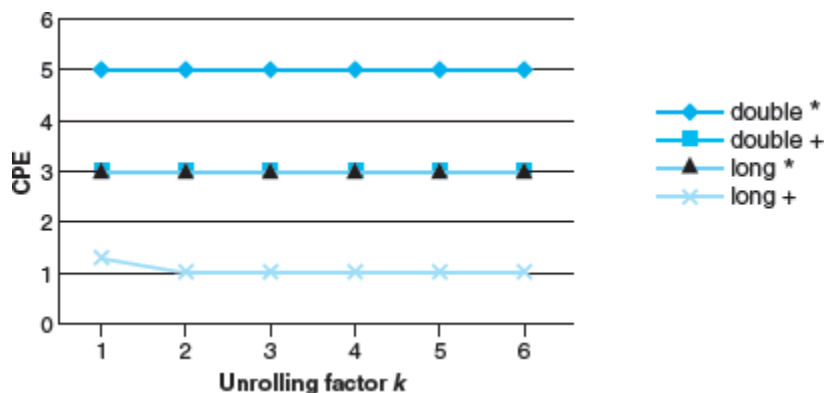
to optionally add a final iteration, as we did with the function `psum2` (Figure 5.1 [□](#)). For  $k > 2$ , the finishing cases are better expressed with a loop, and so we adopt this programming convention for  $k = 2$

as well. We refer to this transformation as " $k \times 1$  loop unrolling," since we unroll by a factor of  $k$  but accumulate values in a single variable `acc`.

## Practice Problem 5.7 (solution page 575)

Modify the code for `combine5` to unroll the loop by a factor  $k = 5$ .

When we measure the performance of unrolled code for unrolling factors  $k = 2$  (`combine5`) and  $k = 3$ , we get the following results:



**Figure 5.17 CPE performance for different degrees of  $k \times 1$  loop unrolling.**

Only integer addition improves with this transformation.

We see that the CPE for integer addition improves, achieving the latency bound of 1.00. This result can be attributed to the benefits of reducing loop overhead operations. By reducing the number of overhead operations relative to the number of additions required to compute the vector sum, we can reach the point where the 1-cycle latency of integer addition becomes the performance-limiting factor. On the other hand, none of the other cases improve—they are already at their latency bounds. [Figure 5.17](#) shows CPE measurements when unrolling the loop by up to a factor of 10. We see that the trends we observed for unrolling by 2 and 3 continue—none go below their latency bounds.

To understand why  $k \times 1$  unrolling cannot improve performance beyond the latency bound, let us examine the machine-level code for the inner loop of `combine5`, having  $k = 2$ . The following code gets generated when type `data_t` is double, and the operation is multiplication:

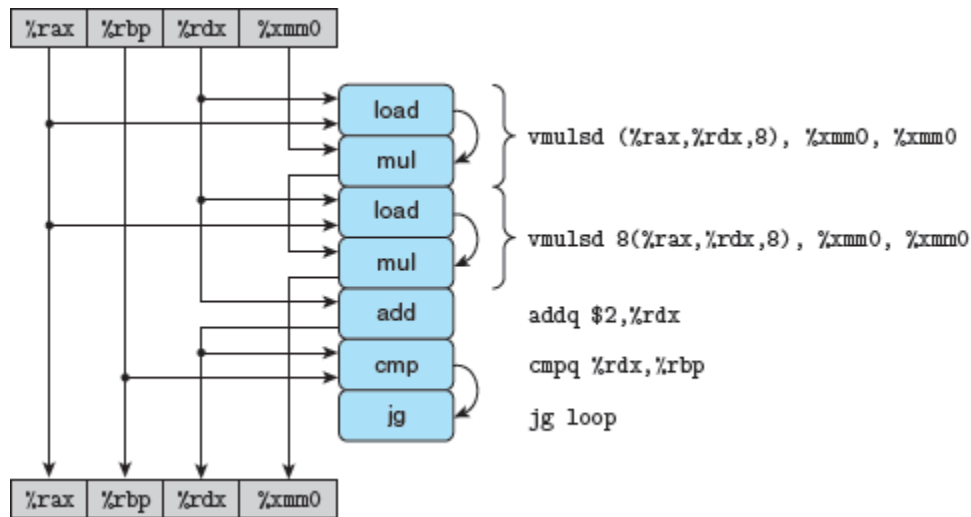
```

|
|   Inner loop of combine5. data_t = double, OP = *
|   i in %rdx, data %rax, limit in %rbx, acc in %xmm0
1   .L35:                                loop:
2       vmulsd (%rax,%rdx,8), %xmm0, %xmm0    Multiply acc
by data[i]
3       vmulsd 8(%rax,%rdx,8), %xmm0, %xmm0    Multiply acc
by data[i+1]
4       addq $2, %rdx                        Increment i by
2
5       cmpq %rdx, %rbp                      Compare to
limit:i
6       jg .L35                              If >, goto
loop

```

We can see that gcc uses a more direct translation of the array referencing seen in the C code, compared to the pointer-based code generated for `combine4`.<sup>2</sup> Loop index `i` is held in register `%rdx`, and the address of data is held in register `%rax`. As before, the accumulated value `acc` is held in vector register `%xmm0`. The loop unrolling leads to two `vmulsd` instructions—one to add `data[i]` to `acc`, and

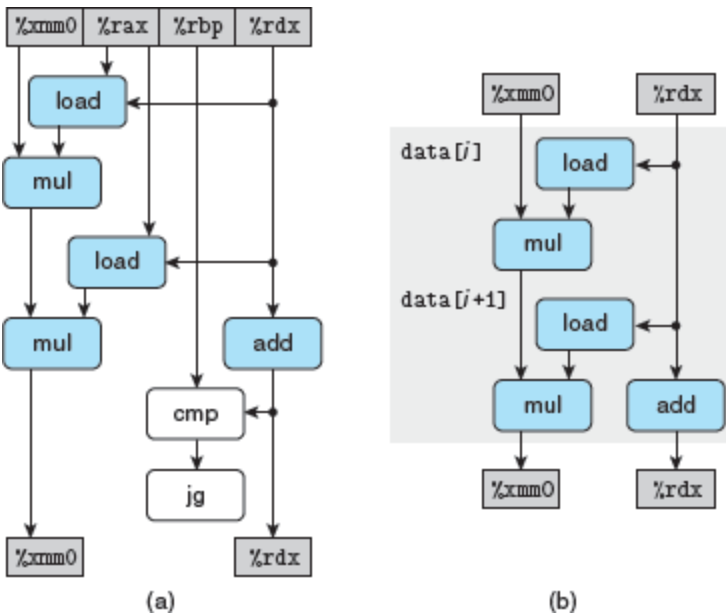
2. The gcc optimizer operates by generating multiple variants of a function and then choosing one that it predicts will yield the best performance and smallest code size. As a consequence, small changes in the source code can yield widely varying forms of machine code. We have found that the choice of pointer-based or array-based code has no impact on the performance of programs running on our reference machine.



**Figure 5.18** Graphical representation of inner-loop code for `combine5`.

Each iteration has two `vmulsd` instructions, each of which is translated into a load and a mul operation.

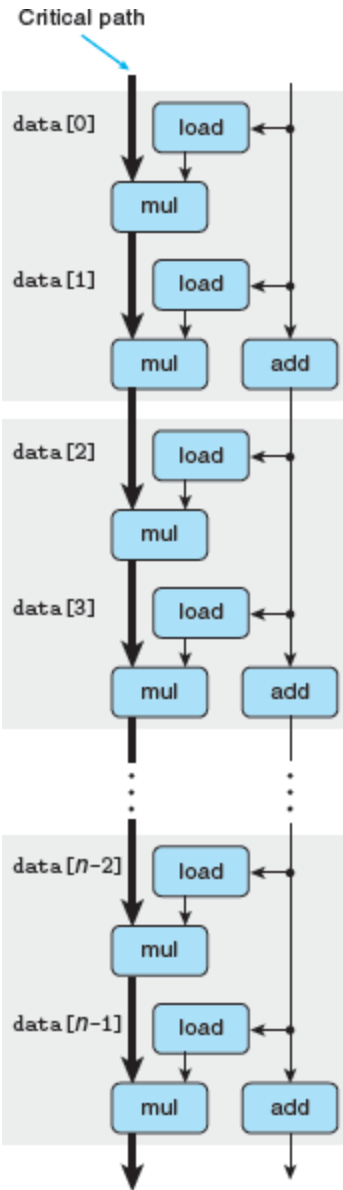




**Figure 5.19** Abstracting `combine5` operations as a data-flow graph.

We rearrange, simplify, and abstract the representation of [Figure 5.18](#) to show the data dependencies between successive iterations (a). We see that each iteration must perform two multiplications in sequence (b).

the second to add `data[i+1]` to `acc`. [Figure 5.18](#) shows a graphical representation of this code. The `vmulsd` instructions each get translated into two operations: one to load an array element from memory and one to multiply this value by the accumulated value. We see here that register `%xmm0` gets read and written twice in each execution of the loop. We can rearrange, simplify, and abstract this graph, following the process shown in [Figure 5.19\(a\)](#), to obtain the template shown in [Figure 5.19\(b\)](#). We then replicate this template  $n/2$  times to show the computation for a vector of length  $n$ , obtaining the data-flow representation



**Figure 5.20** Data-flow representation of `combine5` operating on a vector of length  $n$ .

Even though the loop has been unrolled by a factor of 2, there are still  $n$  mul operations along the critical path.

shown in [Figure 5.20](#). We see here that there is still a critical path of  $n$  mul operations in this graph—there are half as many iterations, but each iteration has two multiplication operations in sequence.

Since the critical path was the limiting factor for the performance of the code without loop unrolling, it remains so with  $k \times 1$  loop unrolling.

## Aside Getting the compiler to unroll loops

Loop unrolling can easily be performed by a compiler. Many compilers do this as part of their collection of optimizations. gcc will perform some forms of loop unrolling when invoked with optimization level 3 or higher.

[OceanofPDF.com](http://OceanofPDF.com)

## 5.9 Enhancing Parallelism

At this point, our functions have hit the bounds imposed by the latencies of the arithmetic units. As we have noted, however, the functional units performing addition and multiplication are all fully pipelined, meaning that they can start new operations every clock cycle, and some of the operations can be performed by multiple functional units. The hardware has the potential to perform multiplications and additions at a much higher rate, but our code cannot take advantage of this capability, even with loop unrolling, since we are accumulating the value as a single variable `acc`. We cannot compute a new value for `acc` until the preceding computation has completed. Even though the functional unit computing a new value for `acc` can start a new operation every clock cycle, it will only start one every  $L$  cycles, where  $L$  is the latency of the combining operation. We will now investigate ways to break this sequential dependency and get performance better than the latency bound.


## 5.9.1 Multiple Accumulators

For a combining operation that is associative and commutative, such as integer addition or multiplication, we can improve performance by splitting the set of combining operations into two or more parts and combining the results at the end. For example, let  $P_n$  denote the product of elements  $a_0, a_1, \dots, a_{n-1}$ :

$$p_n = \prod_{i=0}^{n-1} a_i$$

Assuming  $n$  is even, we can also write this as  $P_n = PE_n \times PO_n$ , where  $PE_n$  is the product of the elements with even indices, and  $PO_n$  is the product of the elements with odd indices:

$$PE_n = \prod_{i=0}^{n/2-1} a_{2i}$$
$$PO_n = \prod_{i=0}^{n/2-1} a_{2i+1}$$

**Figure 5.21**  shows code that uses this method. It uses both two-way loop unrolling, to combine more elements per iteration, and two-way parallelism, accumulating elements with even indices in variable `acc0` and elements with odd indices in variable `acc1`. We therefore refer to this as "2 × 2 loop unrolling." As before, we include a second

loop to accumulate any remaining array elements for the case where the vector length is not a multiple of 2. We then apply the combining operation to `acc0` and `acc1` to compute the final result.

Comparing loop unrolling alone to loop unrolling with two-way parallelism, we obtain the following performance:

```

1      /* 2 x 2 loop unrolling */
2      void combine6(vec_ptr v, data_t *dest)
3      {
4          long i;
5          long length = vec_length(v);
6          long limit = length-1;
7          data_t *data = get_vec_start(v);
8          data_t acc0 = IDENT;
9          data_t acc1 = IDENT;
10
11         /* Combine 2 elements at a time */
12         for (i = 0; i < limit; i+=2) {
13             acc0 = acc0 OP data[i];
14             acc1 = acc1 OP data[i+1];
15         }
16
17         /* Finish any remaining elements */
18         for (;i < length; i++) {
19             acc0 = acc0 OP data[i];
20         }
21         *dest = acc0 OP acc1;
22     }

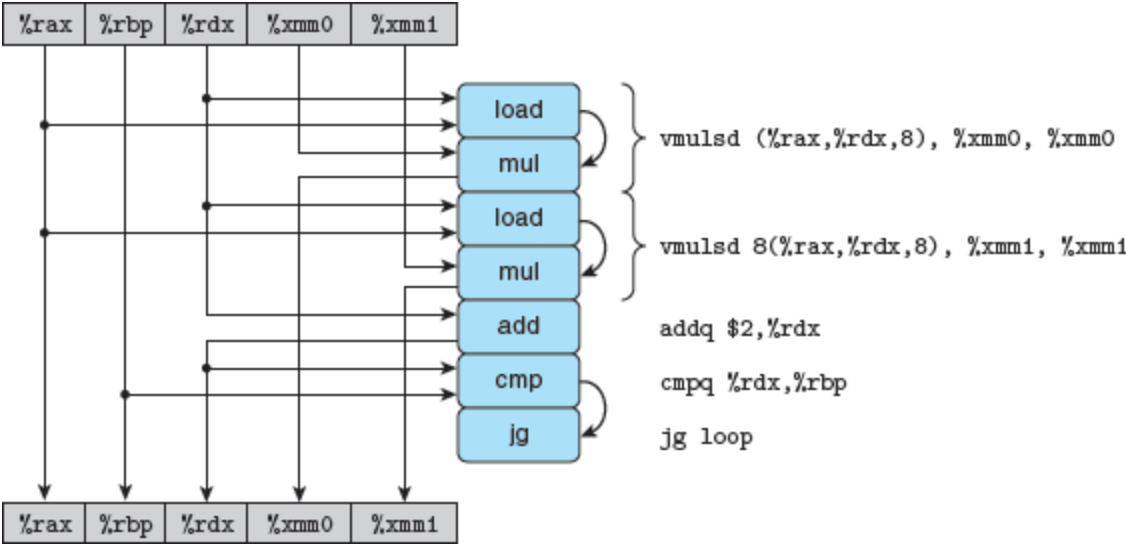
```

**Figure 5.21 Applying 2 × 2 loop unrolling.**

By maintaining multiple accumulators, this approach can make better use of the multiple functional units and their pipelining capabilities.

We see that we have improved the performance for all cases, with integer product, floating-point addition, and floating-point multiplication improving by a factor of around 2, and integer addition improving somewhat as well. Most significantly, we have broken through the barrier imposed by the latency bound. The processor no longer needs to delay the start of one sum or product operation until the previous one has completed.

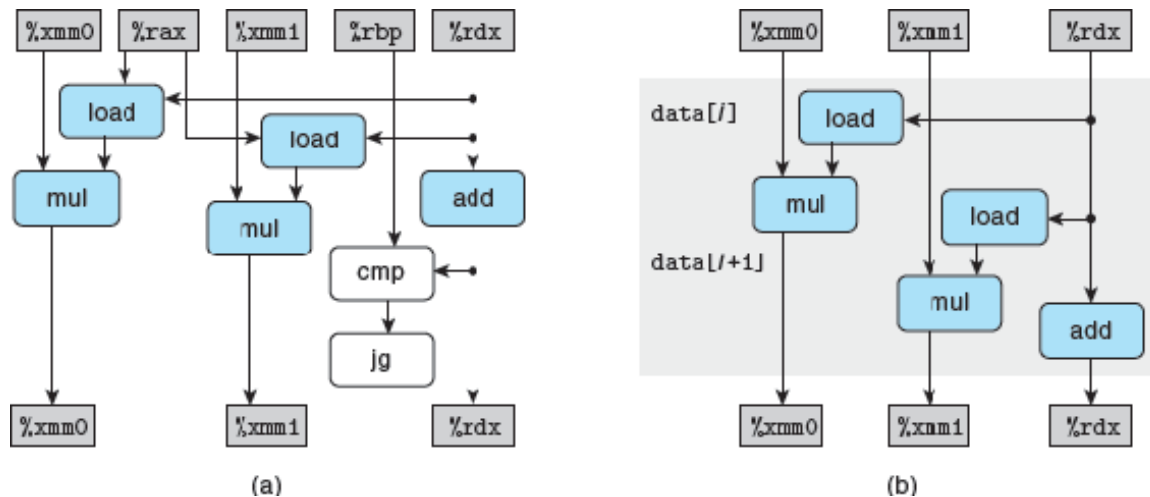
To understand the performance of `combine6`, we start with the code and operation sequence shown in [Figure 5.22](#). We can derive a template showing the



**Figure 5.22** Graphical representation of inner-loop code for `combine6`.

Each iteration has two `vmulsd` instructions, each of which is translated into a load and a mul operation.





**Figure 5.23** Abstracting `combine6` operations as a data-flow graph.

We rearrange, simplify, and abstract the representation of [Figure 5.22](#) to show the data dependencies between successive iterations (a). We see that there is no dependency between the two mul operations (b).

data dependencies between iterations through the process shown in [Figure 5.23](#). As with `combine5`, the inner loop contains two `vmulsd` operations, but these instructions translate into mul operations that read and write separate registers, with no data dependency between them ([Figure 5.23\(b\)](#)). We then replicate this template  $n/2$  times ([Figure 5.24](#)), modeling the execution of the function on a vector of length  $n$ . We see that we now have two critical paths, one corresponding to computing the product of even-numbered elements (program value `acc0`) and

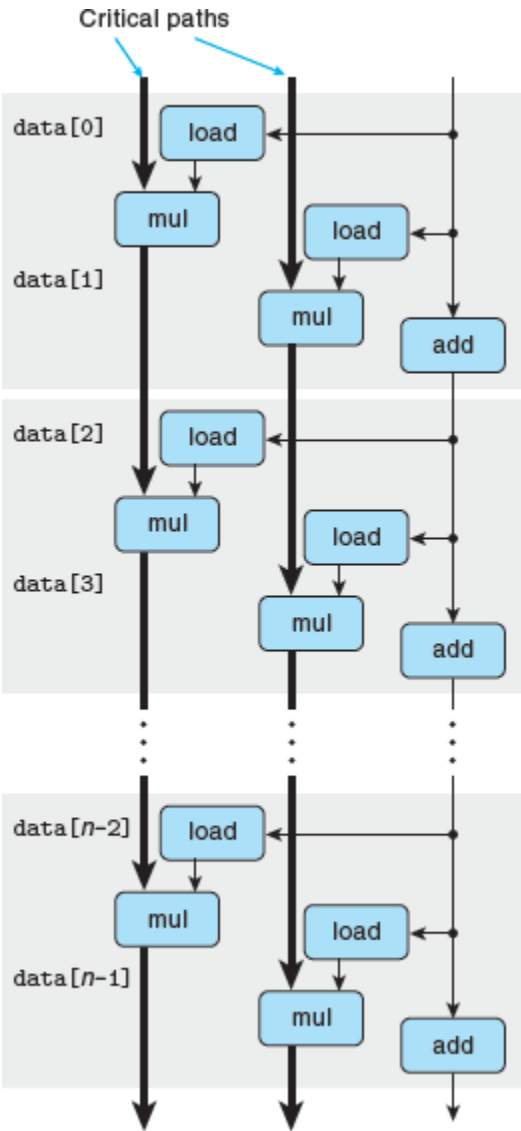



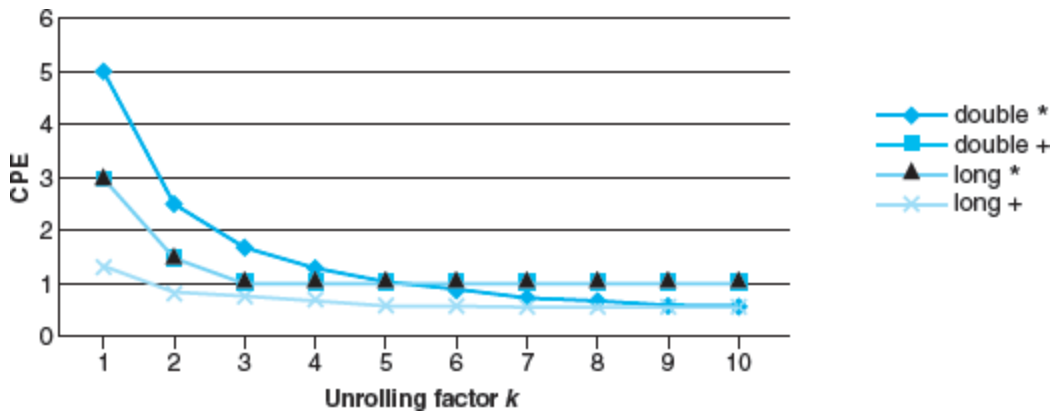
Figure 5.24 Data-flow representation of `combine6` operating on a vector of length  $n$ .

We now have two critical paths, each containing  $n/2$  operations.

one for the odd-numbered elements (program value `acc1`). Each of these critical paths contains only  $n/2$  operations, thus leading to a CPE of around  $5.00/2 = 2.50$ . A similar analysis explains our observed CPE of around  $L/2$  for operations with latency  $L$  for the different combinations of data type and combining operation.

Operationally, the programs are exploiting the capabilities of the functional units to increase their utilization by a factor of 2. The only exception is for integer addition. We have reduced the CPE to below 1.0, but there is still too much loop overhead to achieve the theoretical limit of 0.50.

We can generalize the multiple accumulator transformation to unroll the loop by a factor of  $k$  and accumulate  $k$  values in parallel, yielding  $k \times k$  loop unrolling. **Figure 5.25**  demonstrates the effect of applying this transformation for values up to  $k = 10$ . We can see that, for sufficiently large values of  $k$ , the program can




**Figure 5.25 CPE performance of  $k \times k$  loop unrolling.**

All of the CPEs improve with this transformation, achieving near or at their throughput bounds.

achieve nearly the throughput bounds for all cases. Integer addition achieves a CPE of 0.54 with  $k = 7$ , close to the throughput bound of 0.50 caused by the two load units. Integer multiplication and floating-point addition achieve CPEs of 1.01 when  $k \geq 3$ , approaching the throughput bound of 1.00 set by their functional units. Floating-point

multiplication achieves a CPE of 0.51 for  $k \geq 10$ , approaching the throughput bound of 0.50 set by the two floating-point multipliers and the two load units. It is worth noting that our code is able to achieve nearly twice the throughput with floating-point multiplication as it can with floating-point addition, even though multiplication is a more complex operation.



In general, a program can achieve the throughput bound for an operation only when it can keep the pipelines filled for all of the functional units capable of performing that operation. For an operation with latency  $L$  and capacity  $C$ , this requires an unrolling factor  $k \geq C \cdot L$ . For example, floating-point multiplication has  $C = 2$  and  $L = 5$ , necessitating an unrolling factor of  $k \geq 10$ . Floating-point addition has  $C = 1$  and  $L = 3$ , achieving maximum throughput with  $k \geq 3$ .

In performing the  $k \times k$  unrolling transformation, we must consider whether it preserves the functionality of the original function. We have seen in [Chapter 2](#)  that two's-complement arithmetic is commutative and associative, even when overflow occurs. Hence, for an integer data type, the result computed by `combine6` will be identical to that computed by `combine5` under all possible conditions. Thus, an optimizing compiler could potentially convert the code shown in `combine4` first to a two-way unrolled variant of `combine5` by loop unrolling, and then to that of `combine6` by introducing parallelism. Some compilers do either this or similar transformations to improve performance for integer data.

On the other hand, floating-point multiplication and addition are not associative. Thus, `combine5` and `combine6` could produce different results due to rounding or overflow. Imagine, for example, a product computation in which all of the elements with even indices are numbers with very large absolute values, while those with odd indices are very close to 0.0. In such a case, product  $PE_n$  might overflow, or  $PO_n$  might underflow, even though computing product  $P_n$  proceeds normally. In most real-life applications, however, such patterns are unlikely. Since most physical phenomena are continuous, numerical data tend to be reasonably smooth and well behaved. Even when there are discontinuities, they do not generally cause periodic patterns that lead to a condition such as that sketched earlier. It is unlikely that multiplying the elements in strict order gives fundamentally better accuracy than does multiplying two groups independently and then multiplying those products together. For most applications, achieving a performance gain of 2× outweighs the risk of generating different results for strange data patterns. Nevertheless, a program developer should check with potential users to see if there are particular conditions that may cause the revised algorithm to be unacceptable. Most compilers do not attempt such transformations with floating-point code, since they have no way to judge the risks of introducing transformations that can change the program behavior, no matter how small.

## 5.9.2 Reassociation Transformation

We now explore another way to break the sequential dependencies and thereby improve performance beyond the latency bound. We saw that the  $k \times 1$  loop unrolling of `combine5` did not change the set of operations performed in combining the vector elements to form their sum or product. By a very small change in the code, however, we can fundamentally change the way the combining is performed, and also greatly increase the program performance.

**Figure 5.26**  shows a function `combine7` that differs from the unrolled code of `combine5` (**Figure 5.16** ) only in the way the elements are combined in the inner loop. In `combine5`, the combining is performed by the statement

```
12     acc = (acc OP data[i]) OP data[i+1];
```

while in `combine7` it is performed by the statement

```
12     acc = acc OP (data[i] OP data[i+1]);
```

differing only in how two parentheses are placed. We call this a *reassociation transformation*, because the parentheses shift the order in which the vector elements are combined with the accumulated value `acc`, yielding a form of loop unrolling we refer to as "2 × 1a."

To an untrained eye, the two statements may seem essentially the same, but when we measure the CPE, we get a surprising result:

```

1      /* 2 x 1a loop unrolling */
2      void combine7(vec_ptr v, data_t *dest)
3      {
4          long i;
5          long length = vec_length(v);
6          long limit = length-1;
7          data_t *data = get_vec_start(v);
8          data_t acc = IDENT;
9
10         /* Combine 2 elements at a time */
11         for (i = 0; i < limit; i+=2) {
12             acc = acc OP (data[i] OP data[i+1]);
13         }
14
15         /* Finish any remaining elements */
16         for (;i < length; i++) {
17             acc = acc OP data[i];
18         }
19         *dest = acc;
20     }

```






**Figure 5.26 Applying  $2 \times 1a$  unrolling.**

By reassociating the arithmetic, this approach increases the number of operations that can be performed in parallel.

The integer addition case matches the performance of  $k \times 1$  unrolling (`combine5`), while the other three cases match the performance of the



versions with parallel accumulators (`combine6`), doubling the performance relative to  $k \times 1$  unrolling. These cases have broken through the barrier imposed by the latency bound.

**Figure 5.27**  illustrates how the code for the inner loop of `combine7` (for the case of multiplication as the combining operation and double as data type) gets decoded into operations and the resulting data dependencies. We see that the load operations resulting from the `vmovsd` and the first `vmulsd` instructions load vector elements  $i$  and  $i + 1$  from memory, and the first mul operation multiplies them together. The second mul operation then multiplies this result by the accumulated value `acc`. **Figure 5.28(a)**  shows how we rearrange, refine, and abstract the operations of **Figure 5.27**  to get a template representing the data dependencies for one iteration (**Figure 5.28(b)** ). As with the templates for `combine5` and `combine7`, we have two load and two mul operations, but only one of the mul operations forms a data-dependency chain between loop registers. When we then replicate this template  $n/2$  times to show the computations performed in multiplying  $n$  vector elements (**Figure 5.29** ), we see that we only have  $n/2$  operations along the critical path. The first multiplication within each iteration can be performed without waiting for the accumulated value from the previous iteration. Thus, we reduce the minimum possible CPE by a factor of around 2.

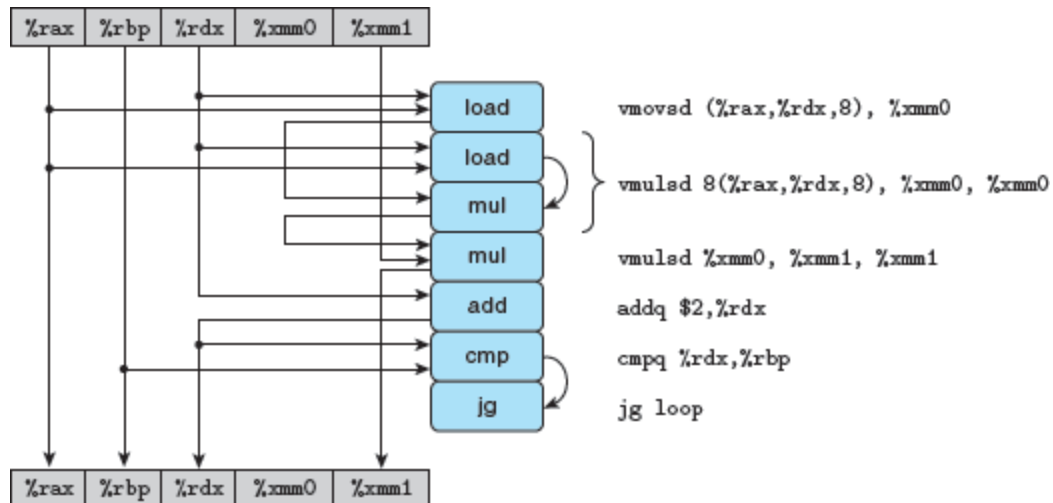
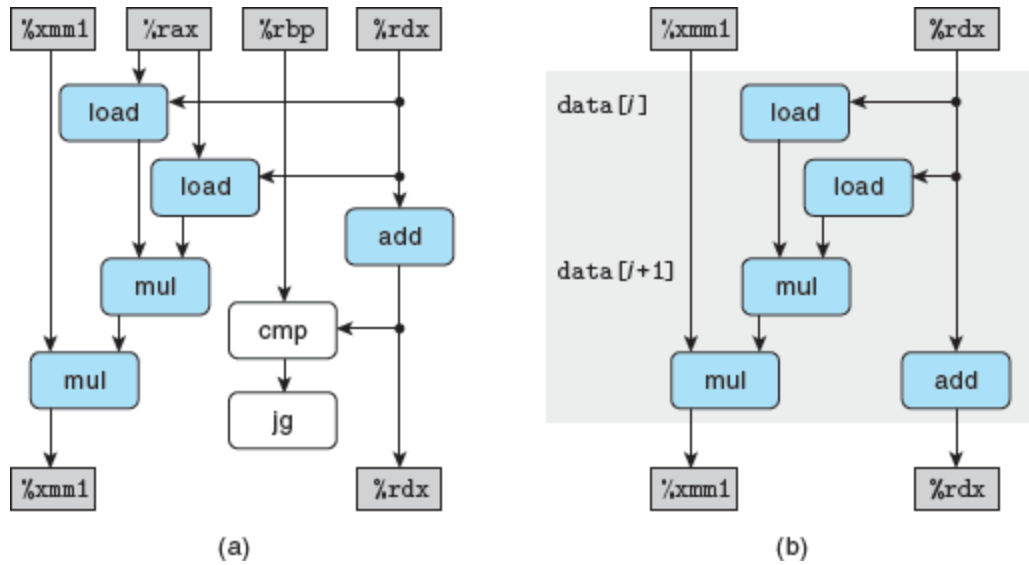


Figure 5.27 Graphical representation of inner-loop code for `combine7`.

Each iteration gets decoded into similar operations as for `combine5` or `combine6`, but with different data dependencies.



**Figure 5.28** Abstracting `combine7` operations as a data-flow graph.

We rearrange, simplify, and abstract the representation of [Figure 5.27](#) to show the data dependencies between successive iterations. The upper `mul` operation multiplies two 2-vector elements with each other, while the lower one multiplies the result by loop variable `acc`.

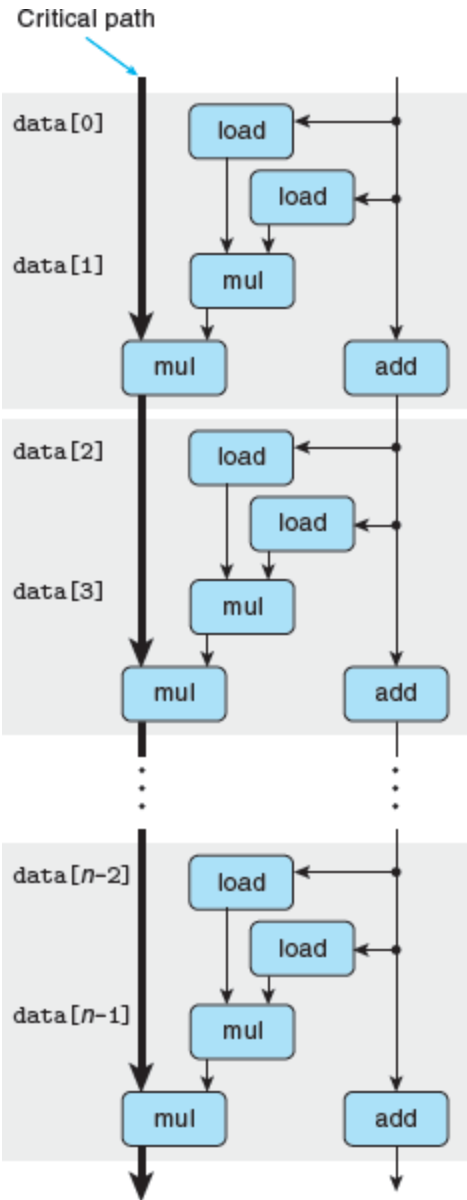



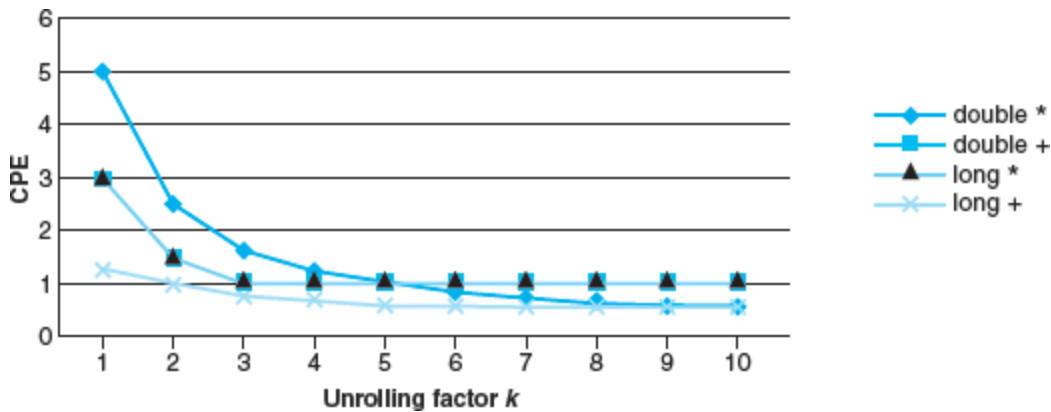
Figure 5.29 Data-flow representation of `combine7` operating on a vector of length  $n$ .

We have a single critical path, but it contains only  $n/2$  operations.

Figure 5.30  demonstrates the effect of applying the reassociation transformation to achieve what we refer to as  $k \times 1a$  loop unrolling for values up to  $k = 10$ . We can see that this transformation yields performance results similar to what is achieved by maintaining  $k$

separate accumulators with  $k \times k$  unrolling. In all cases, we come close to the throughput bounds imposed by the functional units.

In performing the reassociation transformation, we once again change the order in which the vector elements will be combined together. For integer addition and multiplication, the fact that these operations are associative implies that this reordering will have no effect on the result. For the floating-point cases, we must once again assess whether this reassociation is likely to significantly affect



**Figure 5.30 CPE performance for  $k \times 1a$  loop unrolling.**

All of the CPEs improve with this transformation, nearly approaching their throughput bounds.

the outcome. We would argue that the difference would be immaterial for most applications.

In summary, a reassociation transformation can reduce the number of operations along the critical path in a computation, resulting in better performance by better utilizing the multiple functional units and their pipelining capabilities. Most compilers will not attempt any

reassociations of floating-point operations, since these operations are not guaranteed to be associative. Current versions of `gcc` do perform reassociations of integer operations, but not always with good effects. In general, we have found that unrolling a loop and accumulating multiple values in parallel is a more reliable way to achieve improved program performance.

## Practice Problem 5.8 (solution page 576)

Consider the following function for computing the product of an array of  $n$  double-precision numbers. We have unrolled the loop by a factor of 3.

```
|
double aproduct(double a[], long n)
{
    long i;
    double x, y, z;
    double r = 1;
    for (i = 0; i < n-2; i+= 3) {
        x = a[i]; y = a[i+1]; z = a[i+2];
        r = r * x * y * z; /* Product computation
    */
    }
    for (;i < n; i++)
        r *= a[i];
    return r;
}
```

For the line labeled "Product computation," we can use parentheses to create five different associations of the computation, as follows:

```
|  
r = ((r * x) * y) * z; /* A1 */  
r = (r * (x * y)) * z; /* A2 */  
r = r * ((x * y) * z); /* A3 */  
r = r * (x * (y * z)); /* A4 */  
r = (r * x) * (y * z); /* A5 */
```

Assume we run these functions on a machine where floating-point multiplication has a latency of 5 clock cycles. Determine the lower bound on the CPE set by the data dependencies of the multiplication. (*Hint:* It helps to draw a data-flow representation of how `r` is computed on every iteration.)



# Web Aside OPT:SIMD Achieving greater parallelism with vector instructions

As described in [Section 3.1](#), Intel introduced the SSE instructions in 1999, where SSE is the acronym for "streaming SIMD extensions" and, in turn, SIMD (pronounced "sim-dee") is the acronym for "single instruction, multiple data." The SSE capability has gone through multiple generations, with more recent versions being named *advanced vector extensions*, or AVX. The SIMD execution model involves operating on entire vectors of data within single instructions. These vectors are held in a special set of *vector registers*, named `%ymm0-%ymm15`. Current AVX vector registers are 32 bytes long, and therefore each can hold eight 32-bit numbers or four 64-bit numbers, where the numbers can be either integer or floating-point values. AVX instructions can then perform vector operations on these registers, such as adding or multiplying eight or four sets of values in parallel. For example, if YMM register `%ymm0` contains eight single-precision floating-point numbers, which we denote  $a_0, \dots, a_7$ , and `%rcx` contains the memory address of a sequence of eight single-precision floating-point numbers, which we denote  $b_0, \dots, b_7$ , then the instruction

```
vmulps (%rcs), %ymm0, %ymm1
```

will read the eight values from memory and perform eight multiplications in parallel, computing  $a_i \leftarrow a_i \cdot b_i$ , for  $0 < i \leq 7$  and storing the resulting eight products in vector register `%ymm1`. We see that a single instruction is able to generate a computation over multiple data values, hence the term "SIMD."

gcc supports extensions to the C language that let programmers express a program in terms of vector operations that can be compiled into the vector instructions of AVX (as well as code based on the earlier SSE instructions). This coding style is preferable to writing code directly in assembly language, since gcc can also generate code for the vector instructions found on other processors.

Using a combination of gcc instructions, loop unrolling, and multiple accumulators, we are able to achieve the following performance for our combining functions:

In this chart, the first set of numbers is for conventional, *scalar* code written in the style of `combine6`, unrolling by a factor of 10 and maintaining 10 accumulators. The second set of numbers is for code written in a form that `gcc` can compile into AVX vector code. In addition to using vector operations, this version unrolls the main loop by a factor of 8 and maintains eight separate vector accumulators. We show results for both 32-bit and 64-bit numbers, since the vector instructions achieve 8-way parallelism in the first case, but only 4-way parallelism in the second.

We can see that the vector code achieves almost an eightfold improvement on the four 32-bit cases, and a fourfold improvement on three of the four 64-bit cases. Only the long integer multiplication code does not perform well when we attempt to express it in vector code. The AVX instruction set does not include one to do parallel multiplication of 64-bit integers, and so `gcc` cannot generate vector code for this case. Using vector instructions creates a new throughput bound for the combining operations. These are eight times lower for 32-bit operations and four times lower for 64-bit operations than the scalar limits. Our code comes close to achieving these bounds for several combinations of data type and operation.

## 5.10 Summary of Results for Optimizing Combining Code

Our efforts at maximizing the performance of a routine that adds or multiplies the elements of a vector have clearly paid off. The following summarizes the results we obtain with *scalar* code, not making use of the vector parallelism provided by AVX vector instructions:

By using multiple optimizations, we have been able to achieve CPEs close to the throughput bounds of 0.50 and 1.00, limited only by the capacities of the functional units. These represent 10–20× improvements on the original code. This has all been done using ordinary C code and a standard compiler. Rewriting the code to take advantage of the newer SIMD instructions yields additional performance gains of nearly 4× or 8×. For example, for single-precision multiplication, the CPE drops from the original value of 11.14 down to 0.06, an overall performance gain of over 180×. This example demonstrates that modern processors have considerable amounts of computing power, but we may need to coax this power out of them by writing our programs in very stylized ways.

## 5.11 Some Limiting Factors

We have seen that the critical path in a data-flow graph representation of a program indicates a fundamental lower bound on the time required to execute a program. That is, if there is some chain of data dependencies in a program where the sum of all of the latencies along that chain equals  $T$ , then the program will require at least  $T$  cycles to execute.

We have also seen that the throughput bounds of the functional units also impose a lower bound on the execution time for a program. That is, assume that a program requires a total of  $N$  computations of some operation, that the microprocessor has  $C$  functional units capable of performing that operation, and that these units have an issue time of  $I$ . Then the program will require at least  $N \cdot I/C$  cycles to execute.

In this section, we will consider some other factors that limit the performance of programs on actual machines.

## 5.11.1 Register Spilling

The benefits of loop parallelism are limited by the ability to express the computation in assembly code. If a program has a degree of parallelism  $P$  that exceeds the number of available registers, then the compiler will resort to *spilling*, storing some of the temporary values in memory, typically by allocating space on the run-time stack. As an example, the following measurements compare the result of extending the multiple accumulator scheme of `combine6` to the cases of  $k = 10$  and  $k = 20$ :

We can see that none of the CPEs improve with this increased unrolling, and some even get worse. Modern x86-64 processors have 16 integer registers and can make use of the 16 YMM registers to store floating-point data. Once the number of loop variables exceeds the number of available registers, the program must allocate some on the stack.

As an example, the following snippet of code shows how accumulator `acc0` is updated in the inner loop of the code with  $10 \times 10$  unrolling:

```
Updating of accumulator acc0 in 10 x 10 urolling  
vmulsd (%rdx), %xmm0, %xmm0    acc0 *= data[i]
```

We can see that the accumulator is kept in register `%xmm0`, and so the program can simply read `data[i]` from memory and multiply it by this register.


The comparable part of the code for  $20 \times 20$  unrolling has a much different form:

```
Updating of accumulator acc0 in 20 x 20 unrolling  
vmovsd 40(%rsp), %xmm0  
vmulsd (%rdx), %xmm0, %xmm0  
vmovsd %xmm0, 40(%rsp)
```

The accumulator is kept as a local variable on the stack, at offset 40 from the stack pointer. The program must read both its value and the value of `data[i]` from memory, multiply them, and store the result back to memory.

Once a compiler must resort to register spilling, any advantage of maintaining multiple accumulators will most likely be lost. Fortunately, x86-64 has enough registers that most loops will become throughput limited before this occurs.

## 5.11.2 Branch Prediction and Misprediction Penalties

We demonstrated via experiments in [Section 3.6.6](#)  that a conditional branch can incur a significant *misprediction penalty* when the branch prediction logic does not correctly anticipate whether or not a branch will be taken. Now that we have learned something about how processors operate, we can understand where this penalty arises.

Modern processors work well ahead of the currently executing instructions, reading new instructions from memory and decoding them to determine what operations to perform on what operands. This *instruction pipelining* works well as long as the instructions follow in a simple sequence. When a branch is encountered, the processor must guess which way the branch will go. For the case of a conditional jump, this means predicting whether or not the branch will be taken. For an instruction such as an indirect jump (as we saw in the code to jump to an address specified by a jump table entry) or a procedure return, this means predicting the target address. In this discussion, we focus on conditional branches.

In a processor that employs *speculative execution*, the processor begins executing the instructions at the predicted branch target. It does this in a way that avoids modifying any actual register or memory locations until the actual outcome has been determined. If



the prediction is correct, the processor can then "commit" the results of the speculatively executed instructions by storing them in registers or memory. If the prediction is incorrect, the processor must discard all of the speculatively executed results and restart the instruction fetch process at the correct location. The misprediction penalty is incurred in doing this, because the instruction pipeline must be refilled before useful results are generated.

We saw in [Section 3.6.6](#) that recent versions of x86 processors, including all processors capable of executing x86-64 programs, have *conditional move* instructions. gcc can generate code that uses these instructions when compiling conditional statements and expressions, rather than the more traditional realizations based on conditional transfers of control. The basic idea for translating into conditional moves is to compute the values along both branches of a conditional expression or statement and then use conditional moves to select the desired value. We saw in [Section 4.5.7](#) that conditional move instructions can be implemented as part of the pipelined processing of ordinary instructions. There is no need to guess whether or not the condition will hold, and hence no penalty for guessing incorrectly.

How, then, can a C programmer make sure that branch misprediction penalties do not hamper a program's efficiency? Given the 19-cycle misprediction penalty we measured for the reference machine, the stakes are very high. There is no simple answer to this question, but the following general principles apply.

## *Do Not Be Overly Concerned about Predictable Branches*

We have seen that the effect of a mispredicted branch can be very high, but that does not mean that all program branches will slow a program down. In fact, the branch prediction logic found in modern processors is very good at discerning regular patterns and long-term trends for the different branch instructions. For example, the loop-closing branches in our combining routines would typically be predicted as being taken, and hence would only incur a misprediction penalty on the last time around.

As another example, consider the results we observed when shifting from `combine2` to `combine3`, when we took the function `get_vec_element` out of the inner loop of the function, as is reproduced below:

The CPE did not improve, even though the transformation eliminated two conditionals on each iteration that check whether the vector index is within bounds. For this function, the checks always succeed, and hence they are highly predictable.

As a way to measure the performance impact of bounds checking, consider the following combining code, where we have modified the inner loop of `combine4` by replacing the access to the data element with the result of performing an inline substitution of the code for `get_vec_element`. We will call this new version `combine4b`. This code

performs bounds checking and also references the vector elements through the vector data structure.

```
1      /* Include bounds check in loop */
2      void combine4b(vec_ptr v, data_t *dest)
3      {
4          long i;
5          long length = vec_length(v);
6          data_t acc = IDENT;
7
8          for (i = 0; i < length; i++) {
9              if (i >= 0 && i < v->len) {
10                 acc = acc OP v->data[i];
11             }
12         }
13         *dest = acc;
14     }
```

We can then directly compare the CPE for the functions with and without bounds checking:

The version with bounds checking is slightly slower for the case of integer addition, but it achieves the same performance for the other three cases. The performance of these cases is limited by the latencies of their respective combining operations. The additional computation required to perform bounds checking can take place in parallel with the combining operations. The processor is able to predict the outcomes of these branches, and so none of this evaluation has much effect on the fetching and processing of the instructions that form the critical path in the program execution.

## *Write Code Suitable for Implementation with Conditional Moves*

Branch prediction is only reliable for regular patterns. Many tests in a program are completely unpredictable, dependent on arbitrary features of the data, such as whether a number is negative or positive. For these, the branch prediction logic will do very poorly. For inherently unpredictable cases, program performance can be greatly enhanced if the compiler is able to generate code using conditional data transfers rather than conditional control transfers. This cannot be controlled directly by the C programmer, but some ways of expressing conditional behavior can be more directly translated into conditional moves than others.

We have found that `gcc` is able to generate conditional moves for code written in a more "functional" style, where we use conditional operations to compute values and then update the program state with these values, as opposed to a more "imperative" style, where we use conditionals to selectively update program state.

There are no strict rules for these two styles, and so we illustrate with an example. Suppose we are given two arrays of integers `a` and `b`, and at each position `i`, we want to set `a[i]` to the minimum of `a[i]` and `b[i]`, and `b[i]` to the maximum.

An imperative style of implementing this function is to check at each position `i` and swap the two elements if they are out of order:

```

1      /* Rearrange two vectors so that for each i, b[i] >=
a[i] */
2      void minmax1(long a[], long b[], long n) {
3          long i;
4          for (i = 0; i < n; i++) {
5              if (a[i] > b[i]) {
6                  long t = a[i];
7                  a[i] = b[i];
8                  b[i] = t;
9              }
10         }
11     }

```

Our measurements for this function show a CPE of around 13.5 for random data and 2.5-3.5 for predictable data, an indication of a misprediction penalty of around 20 cycles.

A functional style of implementing this function is to compute the minimum and maximum values at each position  $i$  and then assign these values to `a[i]` and `b[i]`, respectively:

```

1      /* Rearrange two vectors so that for each i, b[i] >=
a[i] */
2      void minmax2(long a[], long b[], long n) {
3          long i;
4          for (i = 0; i < n; i++) {
5              long min = a[i] < b[i] ? a[i] : b[i];
6              long max = a[i] < b[i] ? b[i] : a[i];
7              a[i] = min;
8              b[i] = max;
9          }
10     }

```

Our measurements for this function show a CPE of around 4.0 regardless of whether the data are arbitrary or predictable. (We also examined the generated assembly code to make sure that it indeed uses conditional moves.)

As discussed in [Section 3.6.6](#), not all conditional behavior can be implemented with conditional data transfers, and so there are inevitably cases where programmers cannot avoid writing code that will lead to conditional branches for which the processor will do poorly with its branch prediction. But, as we have shown, a little cleverness on the part of the programmer can sometimes make code more amenable to translation into conditional data transfers. This requires some amount of experimentation, writing different versions

of the function and then examining the generated assembly code and measuring performance.



## Practice Problem 5.9 (solution page [576](#))

The traditional implementation of the merge step of mergesort requires three loops [\[98\]](#):

```
1      void merge(long src1[], long src2[], long dest[],
long n) {
2          long i1 = 0;
3          long i2 = 0;
4          long id = 0;
5          while (i1 < n && i2 < n) {
6              if (src1[i1] < src2[i2])
7                  dest[id++] = src1[i1++];
8              else
9                  dest[id++] = src2[i2++];
10         }
11         while (i1 < n)
12             dest[id++] = src1[i1++];
13         while (i2 < n)
14             dest[id++] = src2[i2++];
15     }
```

The branches caused by comparing variables `i1` and `i2` to `n` have good prediction performance—the only mispredictions occur when they first become false. The comparison between values `src1[i1]` and `src2[i2]` (line 6), on the other hand, is highly unpredictable for typical data. This comparison controls

a conditional branch, yielding a CPE (where the number of elements is  $2n$ ) of around 15.0 when run on random data. Rewrite the code so that the effect of the conditional statement in the first loop (lines 6-9) can be implemented with a conditional move.


[OceanofPDF.com](http://OceanofPDF.com)

## 5.12 Understanding Memory Performance


All of the code we have written thus far, and all the tests we have run, access relatively small amounts of memory. For example, the combining routines were measured over vectors of length less than 1,000 elements, requiring no more than 8,000 bytes of data. All modern processors contain one or more *cache* memories to provide fast access to such small amounts of memory. In this section, we will further investigate the performance of programs that involve load (reading from memory into registers) and store (writing from registers to memory) operations, considering only the cases where all data are held in cache. In [Chapter 6](#), we go into much more detail about how caches work, their performance characteristics, and how to write code that makes best use of caches.

As [Figure 5.11](#) shows, modern processors have dedicated functional units to perform load and store operations, and these units have internal buffers to hold sets of outstanding requests for memory operations. For example, our reference machine has two load units, each of which can hold up to 72 pending read requests. It has a single store unit with a store buffer containing up to 42 write requests. Each of these units can initiate 1 operation every clock cycle.

## 5.12.1 Load Performance

The performance of a program containing load operations depends on both the pipelining capability and the latency of the load unit. In our experiments with combining operations using our reference machine, we saw that the CPE never got below 0.50 for any combination of data type and combining operation, except when using SIMD operations. One factor limiting the CPE for our examples is that they all require reading one value from memory for each element computed. With two load units, each able to initiate at most 1 load operation every clock cycle, the CPE cannot be less than 0.50. For applications where we must load  $k$  values for every element computed, we can never achieve a CPE lower than  $k/2$  (see, for example, [Problem 5.15](#) .

In our examples so far, we have not seen any performance effects due to the latency of load operations. The addresses for our load operations depended only on the loop index  $i$ , and so the load operations did not form part of a performance-limiting critical path.

To determine the latency of the load operation on a machine, we can set up a computation with a sequence of load operations, where the outcome of one determines the address for the next. As an example, consider the function `list_len` in [Figure 5.31](#) , which computes the length of a linked list. In the loop of this function, each successive value of variable `ls` depends on the value read by the

pointer reference `ls->next`. Our measurements show that function `list_len` has

```
1     typedef struct ELE {
2         struct ELE *next;
3         long data;
4     } list_ele, *list_ptr;
5
6     long list_len(list_ptr ls) {
7         long len = 0;
8         while (ls) {
9             len++;
10            ls = ls->next;
11        }
12        return len;
13    }
```

**Figure 5.31 Linked list function.**

Its performance is limited by the latency of the load operation.

a CPE of 4.00, which we claim is a direct indication of the latency of the load operation. To see this, consider the assembly code for the loop:

```


|
|   Inner loop of list_len
|   ls in %rdi, len in %rax
1   .L3:                               loop:
2   addq $1, %rax                       Increment len
3   movq (%rdi), %rdi                   ls = ls->next
4   testq %rdi, %rdi                    Test ls
5   jne .L3                              If nonnull, goto loop


```

The `movq` instruction on line 3 forms the critical bottleneck in this loop. Each successive value of register `%rdi` depends on the result of a load operation having the value in `%rdi` as its address. Thus, the load operation for one iteration cannot begin until the one for the previous iteration has completed. The CPE of 4.00 for this function is determined by the latency of the load operation. Indeed, this measurement matches the documented access time of 4 cycles for the reference machine's L1 cache, as is discussed in [Section 6.4](#).

## 5.12.2 Store Performance

In all of our examples thus far, we analyzed only functions that reference memory mostly with load operations, reading from a memory location into a register. Its counterpart, the *store* operation, writes a register value to memory. The performance of this operation, particularly in relation to its interactions with load operations, involves several subtle issues.

As with the load operation, in most cases, the store operation can operate in a fully pipelined mode, beginning a new store on every cycle. For example, consider the function shown in [Figure 5.32](#)  that sets the elements of an array `dest` of length `n` to zero. Our measurements show a CPE of 1.0. This is the best we can achieve on a machine with a single store functional unit.

Unlike the other operations we have considered so far, the store operation does not affect any register values. Thus, by their very nature, a series of store operations cannot create a data dependency. Only a load operation is affected by the result of a store operation, since only a load can read back the memory value that has been written by the store. The function `write_read` shown in [Figure 5.33](#) 

```
1      /* Set elements of array to 0 */  
2      void clear_array(long *dest, long n) {  
3          long i;  
4          for (i = 0; i < n; i++)  
5              dest[i] = 0;  
6      }
```

**Figure 5.32 Function to set array elements to 0.**

This code achieves a CPE of 1.0.



```

1      /* Write to dest, read from src */
2      void write_read(long *src, long *dst, long n)
3      {
4          long cnt = n;
5          long val = 0;
6          while (cnt) {
7              *dst = val;
8              val = (*src)+1;
9              cnt--;
10         }
11     }
12 }

```

**Example A:** `write_read(&a[0], &a[1], 3)`

	Initial	Iter. 1	Iter. 2	Iter. 3
cnt	3	2	1	0
a	-10   17	-10   0	-10   -9	-10   -9
val	0	-9	-9	-9


**Example B:** `write_read(&a[0], &a[0], 3)`


	Initial	Iter. 1	Iter. 2	Iter. 3
cnt	3	2	1	0
a	-10   17	0   17	1   17	2   17
val	0	1	2	3

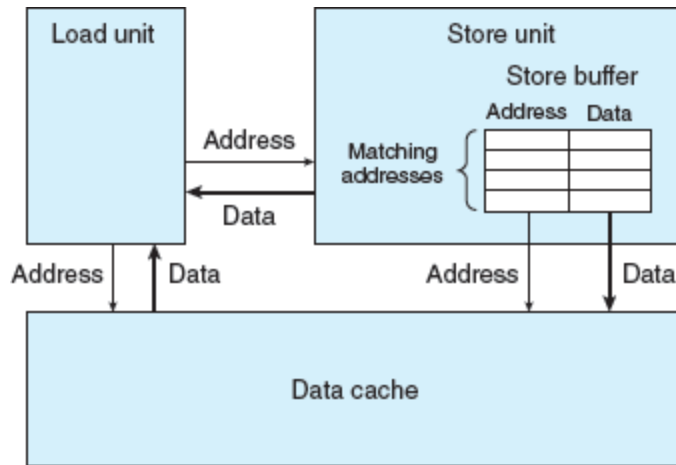
**Figure 5.33** Code to write and read memory locations, along with illustrative executions.

This function highlights the interactions between stores and loads when arguments `src` and `dest` are equal.

illustrates the potential interactions between loads and stores. This figure also shows two example executions of this function, when it is called for a two-element array `a`, with initial contents `-10` and `17`, and with argument `cnt` equal to `3`. These executions illustrate some subtleties of the load and store operations.

In Example A of [Figure 5.33](#) , argument `src` is a pointer to array element `a[0]`, while `dest` is a pointer to array element `a[1]`. In this case, each load by the pointer reference `*src` will yield the value `-10`. Hence, after two iterations, the array elements will remain fixed at `-10` and `-9`, respectively. The result of the read from `src` is not affected by the write to `dest`. Measuring this example over a larger number of iterations gives a CPE of `1.3`.

In Example B of [Figure 5.33](#) , both arguments `src` and `dest` are pointers to array element `a[0]`. In this case, each load by the pointer reference `*src` will yield the value stored by the previous execution of the pointer reference `*dest`.



**Figure 5.34 Detail of load and store units.**

The store unit maintains a buffer of pending writes. The load unit must check its address with those in the store unit to detect a write/read dependency.

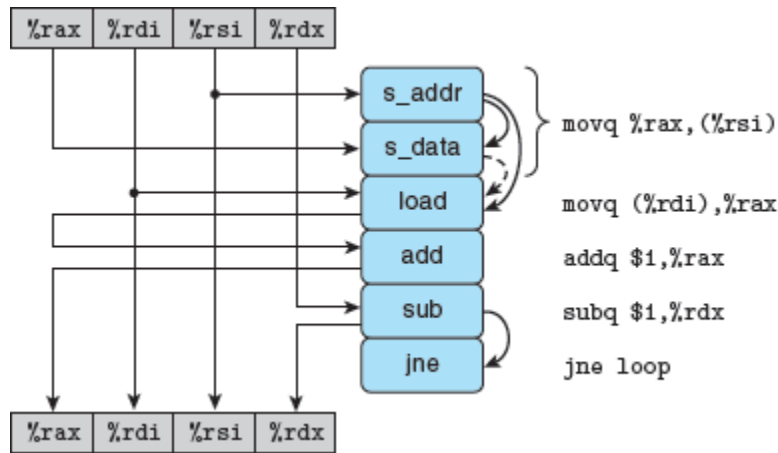
As a consequence, a series of ascending values will be stored in this location. In general, if function `write_read` is called with arguments `src` and `dest` pointing to the same memory location, and with argument `cnt` having some value  $n > 0$ , the net effect is to set the location to  $n - 1$ . This example illustrates a phenomenon we will call a *write/read dependency*—the outcome of a memory read depends on a recent memory write. Our performance measurements show that Example B has a CPE of 7.3. The write/read dependency causes a slowdown in the processing of around 6 clock cycles.

To see how the processor can distinguish between these two cases and why one runs slower than the other, we must take a more detailed look at the load and store execution units, as shown in [Figure 5.34](#). The store unit includes a *store buffer* containing the

addresses and data of the store operations that have been issued to the store unit, but have not yet been completed, where completion involves updating the data cache. This buffer is provided so that a series of store operations can be executed without having to wait for each one to update the cache. When a load operation occurs, it must check the entries in the store buffer for matching addresses. If it finds a match (meaning that any of the bytes being written have the same address as any of the bytes being read), it retrieves the corresponding data entry as the result of the load operation.

gcc generates the following code for the inner loop of `write_read`:

```
|  
Inner loop of write_read  
src in %rdi, dst in %rsi, val in %rax  
.L3:          loop:  
movq  %rax, (%rsi)    Write val to dst  
movq  (%rdi), %rax    t = *src  
addq  $1, %rax       val = t+1  
subq  $1, %rdx       cnt-  
jne   .L3           If != 0, goto loop
```





**Figure 5.35** Graphical representation of inner-loop code for `write_read`.


The first `movl` instruction is decoded into separate operations to compute the store address and to store the data to memory.

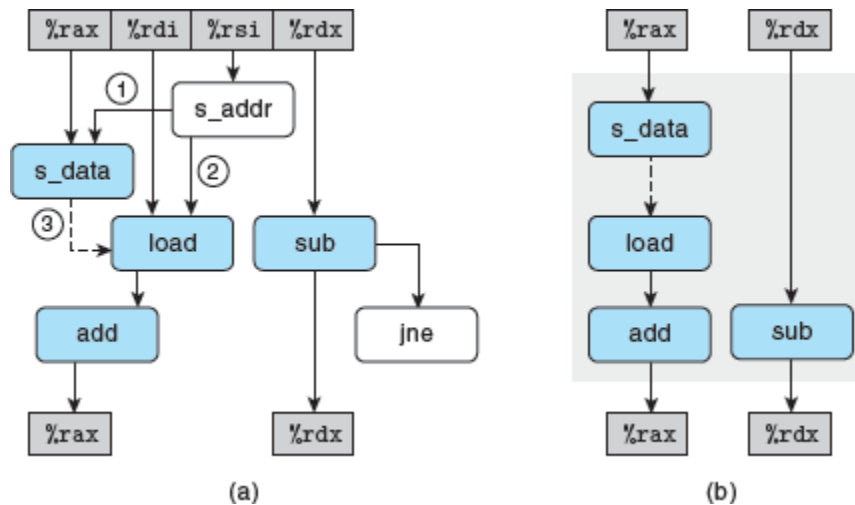
**Figure 5.35** shows a data-flow representation of this loop code. The instruction `movq %rax, (%rsi)` is translated into two operations: The `s_addr` instruction computes the address for the store operation, creates an entry in the store buffer, and sets the address field for that entry. The `s_data` operation sets the data field for the entry. As we will see, the fact that these two computations are performed independently can be important to program performance. This motivates the separate functional units for these operations in the reference machine.

In addition to the data dependencies between the operations caused by the writing and reading of registers, the arcs on the right of the operators denote a set of implicit dependencies for these operations. In particular, the address computation of the `s_addr` operation must clearly precede the `s_data` operation. In addition, the load operation

generated by decoding the instruction `movq (%rdi), %rax` must check the addresses of any pending store operations, creating a data dependency between it and the `s_addr` operation. The figure shows a dashed arc between the `s_data` and load operations. This dependency is conditional: if the two addresses match, the load operation must wait until the `s_data` has deposited its result into the store buffer, but if the two addresses differ, the two operations can proceed independently.

**Figure 5.36**  illustrates the data dependencies between the operations for the inner loop of `write_read`. In **Figure 5.36(a)** , we have rearranged the operations to allow the dependencies to be seen more clearly. We have labeled the three dependencies involving the load and store operations for special attention. The arc labeled "1" represents the requirement that the store address must be computed before the data can be stored. The arc labeled "2" represents the need for the load operation to compare its address with that for any pending store operations. Finally, the dashed arc labeled "3" represents the conditional data dependency that arises when the load and store addresses match.

**Figure 5.36(b)**  illustrates what happens when we take away those operations that do not directly affect the flow of data from one iteration to the next. The data-flow graph shows just two chains of dependencies: the one on the left, with data values being stored, loaded, and incremented (only for the case of matching addresses); and the one on the right, decrementing variable `cnt`.



**Figure 5.36** Abstracting the operations for `write_read`.

We first rearrange the operators of [Figure 5.35\(a\)](#) and then show only those operations that use values from one iteration to produce new values for the next (b).

We can now understand the performance characteristics of function `write_read`. [Figure 5.37](#) illustrates the data dependencies formed by multiple iterations of its inner loop. For the case of Example A in [Figure 5.33](#), with differing source and destination addresses, the load and store operations can proceed independently, and hence the only critical path is formed by the decrementing of variable `cnt`, resulting in a CPE bound of 1.0. For the case of Example B with matching source and destination addresses, the data dependency between the `s_data` and load instructions causes a critical path to form involving data being stored, loaded, and incremented. We found that these three operations in sequence require a total of around 7 clock cycles.

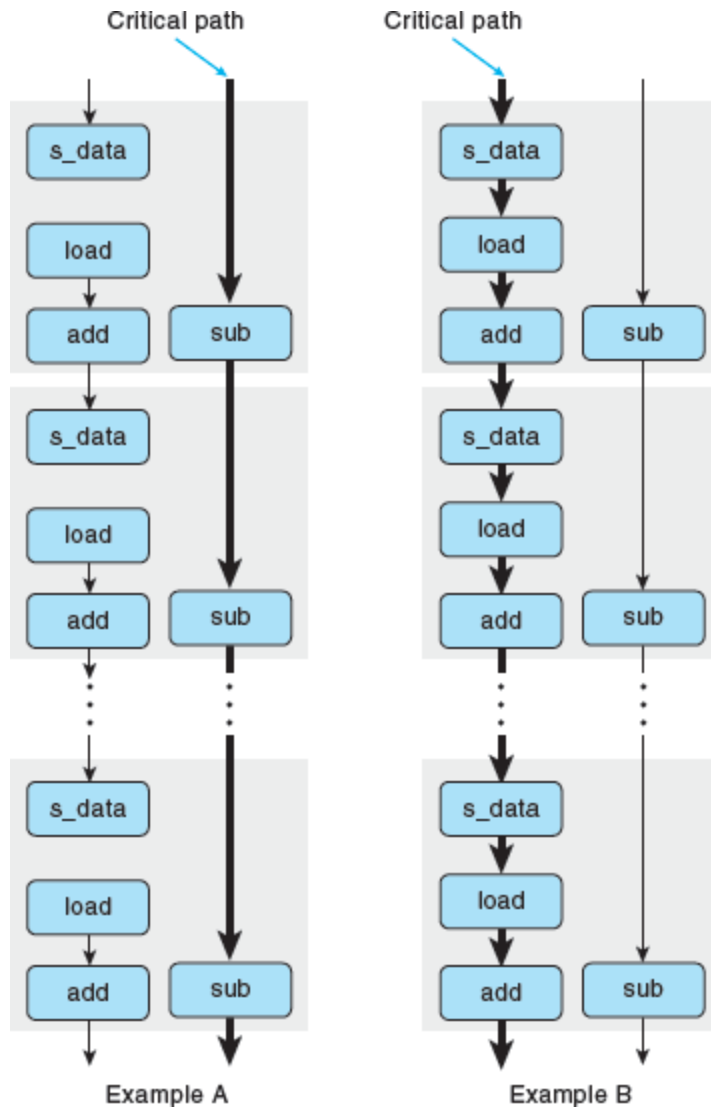
As these two examples show, the implementation of memory operations involves many subtleties. With operations on registers, the processor can determine which instructions will affect which others as they are being decoded into operations. With memory operations, on the other hand, the processor cannot predict which will affect which others until the load and store addresses have been computed. Efficient handling of memory operations is critical to the performance of many programs. The memory subsystem makes use of many optimizations, such as the potential parallelism when operations can proceed independently.



## Practice Problem 5.10 (solution page 577)

As another example of code with potential load-store interactions, consider the following function to copy the contents of one array to another:

```
|  
1 void copy_array(long *src, long *dest, long n)  
2 {  
3     long i;  
4     for (i = 0; i < n; i++)  
5         dest[i] = src[i];  
6 }
```



**Figure 5.37 Data-flow representation of function `write_read`.**

When the two addresses do not match, the only critical path is formed by the decrementing of `cnt` (Example A). When they do match, the chain of data being stored, loaded, and incremented forms the critical path (Example B).

Suppose `a` is an array of length 1,000 initialized so that each element `a[i]` equals  $i$ .

- A. What would be the effect of the call  
`copy_array(a+1, a, 999)?`
- B. What would be the effect of the call  
`copy_array(a, a+1, 999)?`
- C. Our performance measurements indicate that the call of part A has a CPE of 1.2 (which drops to 1.0 when the loop is unrolled by a factor of 4), while the call of part B has a CPE of 5.0. To what factor do you attribute this performance difference?
- D. What performance would you expect for the call  
`copy_array (a, a, 999)?`



Perform an analysis similar to those shown for `combine3` (Figure 5.14) and for `write_read` (Figure 5.36) to diagram the data dependencies created by this loop, and hence the critical path that forms as the computation proceeds. Explain why the CPE is so high.

## *Practice Problem 5.12 (solution page 577)*

Rewrite the code for `psum1` (Figure 5.1) so that it does not need to repeatedly retrieve the value of `p[i]` from memory. You do not need to use loop unrolling. We measured the resulting code to have a CPE of 3.00, limited by the latency of floating-point addition.

# 5.13 Life in the Real World: Performance Improvement Techniques

Although we have only considered a limited set of applications, we can draw important lessons on how to write efficient code. We have described a number of basic strategies for optimizing program performance:

**High-level design.** Choose appropriate algorithms and data structures for the problem at hand. Be especially vigilant to avoid algorithms or coding techniques that yield asymptotically poor performance.

**Basic coding principles.** Avoid optimization blockers so that a compiler can generate efficient code.

- Eliminate excessive function calls. Move computations out of loops when possible. Consider selective compromises of program modularity to gain greater efficiency.
- Eliminate unnecessary memory references. Introduce temporary variables to hold intermediate results. Store a result in an array or global variable only when the final value has been computed.

**Low-level optimizations.** Structure code to take advantage of the hardware capabilities.

- Unroll loops to reduce overhead and to enable further optimizations.
- Find ways to increase instruction-level parallelism by techniques such as multiple accumulators and reassociation.
- Rewrite conditional operations in a functional style to enable compilation via conditional data transfers.

A final word of advice to the reader is to be vigilant to avoid introducing errors as you rewrite programs in the interest of efficiency. It is very easy to make mistakes when introducing new variables, changing loop bounds, and making the code more complex overall. One useful technique is to use checking code to test each version of a function as it is being optimized, to ensure no bugs are introduced during this process. Checking code applies a series of tests to the new versions of a function and makes sure they yield the same results as the original. The set of test cases must become more extensive with highly optimized code, since there are more cases to consider. For example, checking code that uses loop unrolling requires testing for many different loop bounds to make sure it handles all of the different possible numbers of single-step iterations required at the end.

## 5.14 Identifying and Eliminating Performance Bottlenecks

Up to this point, we have only considered optimizing small programs, where there is some clear place in the program that limits its performance and therefore should be the focus of our optimization efforts. When working with large programs, even knowing where to focus our optimization efforts can be difficult. In this section, we describe how to use *code profilers*, analysis tools that collect performance data about a program as it executes. We also discuss some general principles of code optimization, including the implications of Amdahl's law, introduced in [Section 1.9.1](#).



## 5.14.1 Program Profiling

Program *profiling* involves running a version of a program in which instrumentation code has been incorporated to determine how much time the different parts of the program require. It can be very useful for identifying the parts of a program we should focus on in our optimization efforts. One strength of profiling is that it can be performed while running the actual program on realistic benchmark data.

Unix systems provide the profiling program `GPROF`. This program generates two forms of information. First, it determines how much CPU time was spent for each of the functions in the program. Second, it computes a count of how many times each function gets called, categorized by which function performs the call. Both forms of information can be quite useful. The timings give a sense of the relative importance of the different functions in determining the overall run time. The calling information allows us to understand the dynamic behavior of the program.

Profiling with `GPROF` requires three steps, as shown for a C program `prog.c`, which runs with command-line argument `file.txt`:

1. The program must be compiled and linked for profiling. With `gcc` (and other C compilers), this involves simply including the run-time flag `-pg` on the command line. It is important to ensure that the compiler does not attempt to perform any

optimizations via inline substitution, or else the calls to functions may not be tabulated accurately. We use optimization flag `-Og`, guaranteeing that function calls will be tracked properly.

```
linux> gcc -Og -pg prog.c -o prog
```

2. The program is then executed as usual:

```
linux> ./prog file.txt
```

It runs slightly (around a factor of 2) slower than normal, but otherwise the only difference is that it generates a file `gmon.out`.

3. GPROF is invoked to analyze the data in `gmon.out`:

```
linux> gprof prog
```

The first part of the profile report lists the times spent executing the different functions, sorted in descending order. As an example, the following listing shows this part of the report for the three most time-consuming functions in a program:

```

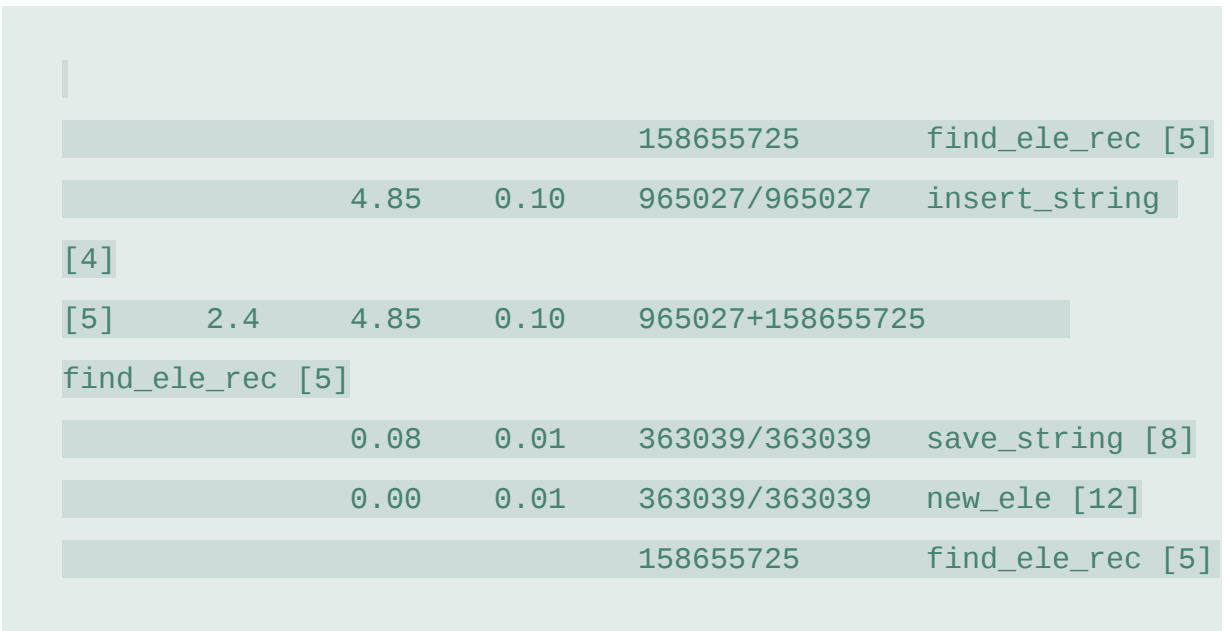
|
%      cumulative      self      self      total
time   seconds         seconds calls    s/call  s/call  name
97.58   203.66           203.66    1    203.66  203.66
sort_words
2.32    208.50             4.85 965027    0.00    0.00
find_ele_rec
0.14    208.81             0.30 12511031    0.00    0.00 Strien

```

Each row represents the time spent for all calls to some function. The first column indicates the percentage of the overall time spent on the function. The second shows the cumulative time spent by the functions up to and including the one on this row. The third shows the time spent on this particular function, and the fourth shows how many times it was called (not counting recursive calls). In our example, the function `sort_words` was called only once, but this single call required 203.66 seconds, while the function `find_ele_rec` was called 965,027 times (not including recursive calls), requiring a total of 4.85 seconds. Function `Strlen` computes the length of a string by calling the library function `strlen`. Library function calls are normally not shown in the results by `GPROF`. Their times are usually reported as part of the function calling them. By creating the "wrapper function" `Strlen`, we can reliably track the calls to `strlen`, showing that it was called 12,511,031 times but only requiring a total of 0.30 seconds.

The second part of the profile report shows the calling history of the functions. The following is the history for a recursive function

`find_ele_rec`:



This history shows both the functions that called `find_ele_rec`, as well as the functions that it called. The first two lines show the calls to the function: 158,655,725 calls by itself recursively, and 965,027 calls by function `insert_string` (which is itself called 965,027 times). Function `find_ele_rec`, in turn, called two other functions, `save_string` and `new_ele`, each a total of 363,039 times.

From these call data, we can often infer useful information about the program behavior. For example, the function `find_ele_rec` is a recursive procedure that scans the linked list for a hash bucket looking for a particular string. For this function, comparing the number of recursive calls with the number of top-level calls provides

statistical information about the lengths of the traversals through these lists. Given that their ratio is 164.4:1, we can infer that the program scanned an average of around 164 elements each time.

Some properties of `GPROF` are worth noting:

- The timing is not very precise. It is based on a simple *interval counting* scheme in which the compiled program maintains a counter for each function recording the time spent executing that function. The operating system causes the program to be interrupted at some regular time interval  $\delta$ . Typical values of  $\delta$  range between 1.0 and 10.0 milliseconds. It then determines what function the program was executing when the interrupt occurred and increments the counter for that function by  $\delta$ . Of course, it may happen that this function just started executing and will shortly be completed, but it is assigned the full cost of the execution since the previous interrupt. Some other function may run between two interrupts and therefore not be charged any time at all.

Over a long duration, this scheme works reasonably well. Statistically, every function should be charged according to the relative time spent executing it. For programs that run for less than around 1 second, however, the numbers should be viewed as only rough estimates.

- The calling information is quite reliable, assuming no inline substitutions have been performed. The compiled program maintains a counter for each combination of caller and callee.

The appropriate counter is incremented every time a procedure is called.

- By default, the timings for library functions are not shown. Instead, these times are incorporated into the times for the calling functions.

## 5.14.2 Using a Profiler to Guide Optimization

As an example of using a profiler to guide program optimization, we created an application that involves several different tasks and data structures. This application analyzes the *n-gram* statistics of a text document, where an *n-gram* is a sequence of *n* words occurring in a document. For  $n = 1$ , we collect statistics on individual words, for  $n = 2$  on pairs of words, and so on. For a given value of *n*, our program reads a text file, creates a table of unique *n*-grams and how many times each one occurs, then sorts the *n*-grams in descending order of occurrence.

As a benchmark, we ran it on a file consisting of the complete works of William Shakespeare, totaling 965,028 words, of which 23,706 are unique. We found that for  $n = 1$ , even a poorly written analysis program can readily process the entire file in under 1 second, and so we set  $n = 2$  to make things more challenging. For the case of  $n = 2$ , *n*-grams are referred to as *bigrams* (pronounced "bye-grams"). We determined that Shakespeare's works contain 363,039 unique bigrams. The most common is "I am," occurring 1,892 times. Perhaps his most famous bigram, "to be," occurs 1,020 times. Fully 266,018 of the bigrams occur only once.

Our program consists of the following parts. We created multiple versions, starting with simple algorithms for the different parts and

then replacing them with more sophisticated ones:



1. Each word is read from the file and converted to lowercase. Our initial version used the function `lower1` (Figure 5.7 ) , which we know to have quadratic run time due to repeated calls to `strlen`.
2. A hash function is applied to the string to create a number between 0 and  $s - 1$ , for a hash table with  $s$  buckets. Our initial function simply summed the ASCII codes for the characters modulo  $s$ .
3. Each hash bucket is organized as a linked list. The program scans down this list looking for a matching entry. If one is found, the frequency for this  $n$ -gram is incremented. Otherwise, a new list element is created. Our initial version performed this operation recursively, inserting new elements at the end of the list.
4. Once the table has been generated, we sort all of the elements according to the frequencies. Our initial version used insertion sort.

Figure 5.38  shows the profile results for six different versions of our  $n$ -gram-frequency analysis program. For each version, we divide the time into the following categories:

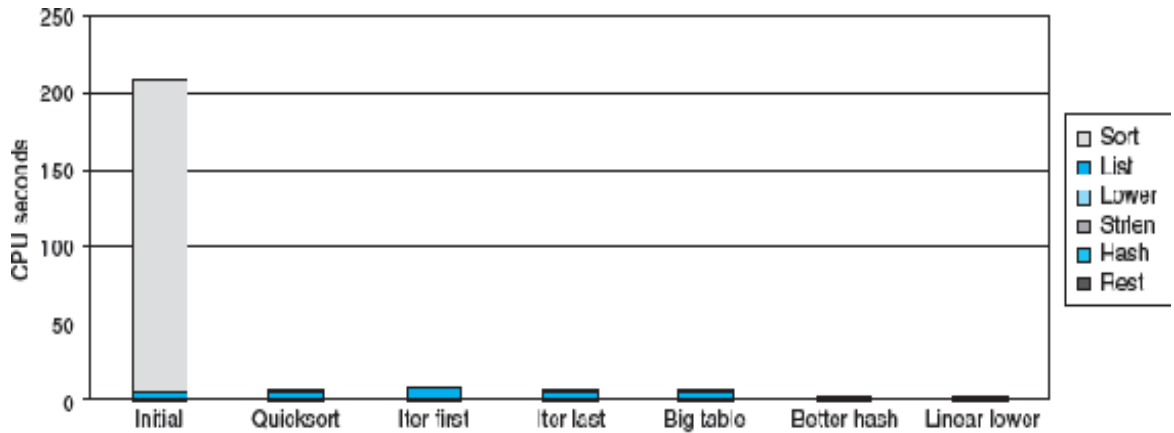
**Sort.** Sorting  $n$ -grams by frequency

**List.** Scanning the linked list for a matching  $n$ -gram, inserting a new element if necessary

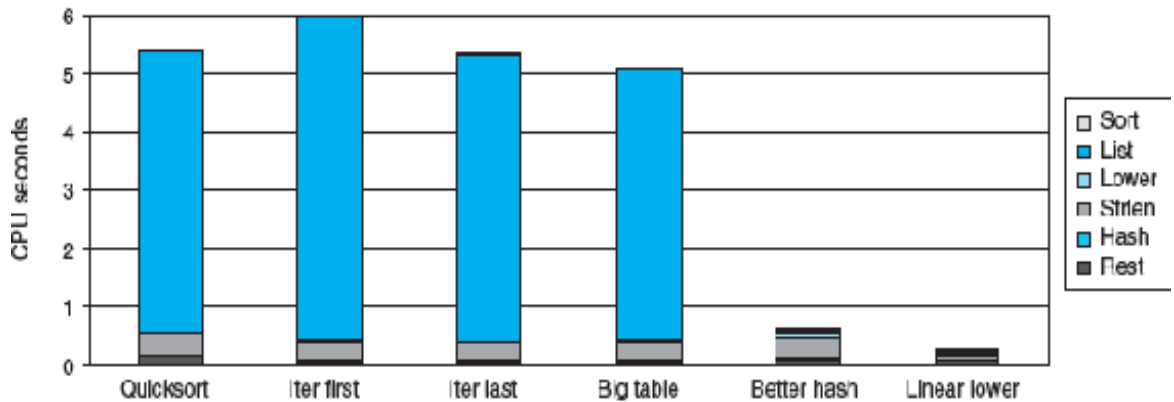


**Lower.** Converting strings to lowercase

**Strlen.** Computing string lengths



(a) All versions



(b) All but the slowest version

**Figure 5.38** Profile results for different versions of bigram-frequency counting program.

Time is divided according to the different major operations in the program.

**Hash.** Computing the hash function

**Rest.** The sum of all other functions

As part (a) of the figure shows, our initial version required 3.5 minutes, with most of the time spent sorting. This is not surprising, since insertion sort has quadratic run time and the program sorted 363,039 values.

In our next version, we performed sorting using the library function `qsort`, which is based on the quicksort algorithm [98]. It has an expected run time of  $O(n \log n)$ . This version is labeled "Quicksort" in the figure. The more efficient sorting algorithm reduces the time spent sorting to become negligible, and the overall run time to around 5.4 seconds. Part (b) of the figure shows the times for the remaining version on a scale where we can see them more clearly.

With improved sorting, we now find that list scanning becomes the bottleneck. Thinking that the inefficiency is due to the recursive structure of the function, we replaced it by an iterative one, shown as "Iter first." Surprisingly, the run time increases to around 7.5 seconds. On closer study, we find a subtle difference between the two list functions. The recursive version inserted new elements at the end of the list, while the iterative one inserted them at the front. To maximize performance, we want the most frequent  $n$ -grams to occur near the beginning of the lists. That way, the function will quickly locate the common cases. Assuming that  $n$ -grams are spread uniformly throughout the document, we would expect the first occurrence of a frequent one to come before that of a less frequent one. By inserting new  $n$ -grams at the end, the first function tended to order  $n$ -grams in descending order of frequency, while the second function tended to do just the opposite. We therefore created a third

list-scanning function that uses iteration but inserts new elements at the end of this list. With this version, shown as "Iter last," the time dropped to around 5.3 seconds, slightly better than with the recursive version. These measurements demonstrate the importance of running experiments on a program as part of an optimization effort. We initially assumed that converting recursive code to iterative code would improve its performance and did not consider the distinction between adding to the end or to the beginning of a list.

Next, we consider the hash table structure. The initial version had only 1,021 buckets (typically, the number of buckets is chosen to be a prime number to enhance the ability of the hash function to distribute keys uniformly among the buckets). For a table with 363,039 entries, this would imply an average *load* of  $363,039/1,021 = 355.6$ . That explains why so much of the time is spent performing list operations—the searches involve testing a significant number of candidate  $n$ -grams. It also explains why the performance is so sensitive to the list ordering. We then increased the number of buckets to 199,999, reducing the average load to 1.8. Oddly enough, however, our overall run time only drops to 5.1 seconds, a difference of only 0.2 seconds.

On further inspection, we can see that the minimal performance gain with a larger table was due to a poor choice of hash function. Simply summing the character codes for a string does not produce a very wide range of values. In particular, the maximum code value for a letter is 122, and so a string of  $n$  characters will generate a sum of at most  $122n$ . The longest bigram in our document,

"honorificabilitudinitatibus\*\*\* thou" sums to just 3,371, and so most of the buckets in our hash table will go unused. In addition, a commutative hash function, such as addition, does not differentiate among the different possible orderings of characters with a string. For example, the words "rat" and "tar" will generate the same sums.


We switched to a hash function that uses shift and EXCLUSIVE-OR operations. With this version, shown as "Better hash," the time drops to 0.6 seconds. A more systematic approach would be to study the distribution of keys among the buckets more carefully, making sure that it comes close to what one would expect if the hash function had a uniform output distribution.

Finally, we have reduced the run time to the point where most of the time is spent in `strlen`, and most of the calls to `strlen` occur as part of the lowercase conversion. We have already seen that function `lower1` has quadratic performance, especially for long strings. The words in this document are short enough to avoid the disastrous consequences of quadratic performance; the longest bigram is just 32 characters. Still, switching to `lower2`, shown as "Linear lower," yields a significant improvement, with the overall time dropping to around 0.2 seconds.

With this exercise, we have shown that code profiling can help drop the time required for a simple application from 3.5 minutes down to 0.2 seconds, yielding a performance gain of around 1,000×. The profiler helps us focus our attention on the most time-consuming parts of the program and also provides useful information about the

procedure call structure. Some of the bottlenecks in our code, such as using a quadratic sort routine, are easy to anticipate, while others, such as whether to append to the beginning or end of a list, emerge only through a careful analysis.

We can see that profiling is a useful tool to have in the toolbox, but it should not be the only one. The timing measurements are imperfect, especially for shorter (less than 1 second) run times. More significantly, the results apply only to the particular data tested. For example, if we had run the original function on data consisting of a smaller number of longer strings, we would have found that the lowercase conversion routine was the major performance bottleneck. Even worse, if it only profiled documents with short words, we might never detect hidden bottlenecks such as the quadratic performance of `lower1`. In general, profiling can help us optimize for *typical* cases, assuming we run the program on representative data, but we should also make sure the program will have respectable performance for all possible cases. This mainly involves avoiding algorithms (such as insertion sort) and bad programming practices (such as `lower1`) that yield poor asymptotic performance.

Amdahl's law, described in [Section 1.9.1](#) , provides some additional insights into the performance gains that can be obtained by targeted optimizations. For our  $n$ -gram code, we saw the total execution time drop from 209.0 to 5.4 seconds when we replaced insertion sort by quicksort. The initial version spent 203.7 of its 209.0 seconds performing insertion sort, giving  $\alpha = 0.974$ , the fraction of time subject to speedup. With quicksort, the time spent sorting

becomes negligible, giving a predicted speedup of  $209/\alpha = 39.0$ , close to the measured speedup of 38.5. We were able to gain a large speedup because sorting constituted a very large fraction of the overall execution time. However, when one bottleneck is eliminated, a new one arises, and so gaining additional speedup required focusing on other parts of the program.

[OceanofPDF.com](http://OceanofPDF.com)

## 5.15 Summary

Although most presentations on code optimization describe how compilers can generate efficient code, much can be done by an application programmer to assist the compiler in this task. No compiler can replace an inefficient algorithm or data structure by a good one, and so these aspects of program design should remain a primary concern for programmers. We also have seen that optimization blockers, such as memory aliasing and procedure calls, seriously restrict the ability of compilers to perform extensive optimizations. Again, the programmer must take primary responsibility for eliminating these. These should simply be considered parts of good programming practice, since they serve to eliminate unneeded work.

Tuning performance beyond a basic level requires some understanding of the processor's microarchitecture, describing the underlying mechanisms by which the processor implements its instruction set architecture. For the case of out-of-order processors, just knowing something about the operations, capabilities, latencies, and issue times of the functional units establishes a baseline for predicting program performance.

We have studied a series of techniques—including loop unrolling, creating multiple accumulators, and reassociation—that can exploit the instruction-level parallelism provided by modern processors. As

we get deeper into the optimization, it becomes important to study the generated assembly code and to try to understand how the computation is being performed by the machine. Much can be gained by identifying the critical paths determined by the data dependencies in the program, especially between the different iterations of a loop. We can also compute a throughput bound for a computation, based on the number of operations that must be computed and the number and issue times of the units that perform those operations.

Programs that involve conditional branches or complex interactions with the memory system are more difficult to analyze and optimize than the simple loop programs we first considered. The basic strategy is to try to make branches more predictable or make them amenable to implementation using conditional data transfers. We must also watch out for the interactions between store and load operations. Keeping values in local variables, allowing them to be stored in registers, can often be helpful.

When working with large programs, it becomes important to focus our optimization efforts on the parts that consume the most time. Code profilers and related tools can help us systematically evaluate and improve program performance. We described `GPROF`, a standard Unix profiling tool. More sophisticated profilers are available, such as the `VTUNE` program development system from Intel, and `VALGRIND`, commonly available on Linux systems. These tools can break down the execution time below the procedure level to estimate the performance of each *basic block* of the program. (A basic block is a



sequence of instructions that has no transfers of control out of its middle, and so the block is always executed in its entirety.)

[OceanofPDF.com](http://OceanofPDF.com)

# Bibliographic Notes

Our focus has been to describe code optimization from the programmer's perspective, demonstrating how to write code that will make it easier for compilers to generate efficient code. An extended paper by Chellappa, Franchetti, and P\$uUschel [19] takes a similar approach but goes into more detail with respect to the processor's characteristics.

Many publications describe code optimization from a compiler's perspective, formulating ways that compilers can generate more efficient code. Muchnick's book is considered the most comprehensive [80]. Wadleigh and Crawford's book on software optimization [115] covers some of the material we have presented, but it also describes the process of getting high performance on parallel machines. An early paper by Mahlke et al. [75] describes how several techniques developed for compilers that map programs onto parallel machines can be adapted to exploit the instruction-level parallelism of modern processors. This paper covers the code transformations we presented, including loop unrolling, multiple accumulators (which they refer to as *accumulator variable expansion*), and reassociation (which they refer to as *tree height reduction*).

Our presentation of the operation of an out-of-order processor is fairly brief and abstract. More complete descriptions of the general

principles can be found in advanced computer architecture textbooks, such as the one by Hennessy and Patterson [46, Ch. 2–3]. Shen and Lipasti's book [100] provides an in-depth treatment of modern processor design.

[OceanofPDF.com](http://OceanofPDF.com)

# Homework Problems

## 5.13 ♦♦

Suppose we wish to write a procedure that computes the inner product of two vectors  $u$  and  $v$ . An abstract version of the function has a CPE of 14–18 with x86-64 for different types of integer and floating-point data. By doing the same sort of transformations we did to transform the abstract program `combine1` into the more efficient `combine4`, we get the following code:

```
1      /* Inner product. Accumulate in temporary */
2      void inner4(vec_ptr u, vec_ptr v, data_t *dest)
3      {
4          long i;
5          long length = vec_length(u);
6          data_t *udata = get_vec_start(u);
7          data_t *vdata = get_vec_start(v);
8          data_t sum = (data_t) 0;
9
10         for (i = 0; i < length; i++) {
11             sum = sum + udata[i] * vdata[i];
12         }
13         *dest = sum;
14     }
```

Our measurements show that this function has CPEs of 1.50 for integer data and 3.00 for floating-point data. For data type double, the x86-64 assembly code for the inner loop is as follows:

```
|
|
|   Inner loop of inner4. data_t = double, OP = *
|   udata in %rbp, vdata in %rax, sum in %xmm0
|   i in %rcx, limit in %rbx
1   .L15:                                loop:
2   vmovsd 0(%rbp,%rcx,8), %xmm1         Get udata[i]
3   vmulsd (%rax,%rcx,8), %xmm1, %xmm1   Multiply by
vdata[i]
4   vaddsd %xmm1, %xmm0, %xmm0          Add to sum
5   addq $1, 7,rcx                       Increment i
6   cmpq %rbx, %rcx                       Compare
i:limit
7   jne .L15                               If !=, goto
loop
```

Assume that the functional units have the characteristics listed in [Figure 5.12](#).

- A. Diagram how this instruction sequence would be decoded into operations and show how the data dependencies between them would create a critical path of operations, in the style of [Figures 5.13](#) and [5.14](#).

- B. For data type double, what lower bound on the CPE is determined by the critical path?
- C. Assuming similar instruction sequences for the integer code as well, what lower bound on the CPE is determined by the critical path for integer data?
- D. Explain how the floating-point versions can have CPEs of 3.00, even though the multiplication operation requires 5 clock cycles.

## 5.14 ♦

Write a version of the inner product procedure described in [Problem 5.13](#) that uses  $6 \times 1$  loop unrolling. For x86-64, our measurements of the unrolled version give a CPE of 1.07 for integer data but still 3.01 for both floating-point data.

- A. Explain why any (scalar) version of an inner product procedure running on an Intel Core i7 Haswell processor cannot achieve a CPE less than 1.00.
- B. Explain why the performance for floating-point data did not improve with loop unrolling.

## 5.15 ♦

Write a version of the inner product procedure described in [Problem 5.13](#) that uses  $6 \times 6$  loop unrolling. Our measurements for this function with x86-64 give a CPE of 1.06 for integer data and 1.01 for floating-point data.

What factor limits the performance to a CPE of 1.00?

## 5.16 ♦

Write a version of the inner product procedure described in [Problem 5.13](#) that uses  $6 \times 1a$  loop unrolling to enable greater parallelism. Our measurements for this function give a CPE of 1.10 for integer data and 1.05 for floating-point data.



## 5.17 ♦♦

The library function `memset` has the following prototype:

```
void *memset(void *s, int c, size_t n);
```

This function fills `n` bytes of the memory area starting at `s` with copies of the low-order byte of `c`. For example, it can be used to zero out a region of memory by giving argument 0 for `c`, but other values are possible.

The following is a straightforward implementation of `memset`:

```

1      /* Basic implementation of memset */
2      void *basic_memset(void *s, int c, size_t n)
3      {
4          size_t cnt = 0;
5          unsigned char *schar = s;
6          while (cnt < n) {
7              *schar++ = (unsigned char) c;
8              cnt++;
9          }
10         return s;
11     }

```

Implement a more efficient version of the function by using a word of data type `unsigned long` to pack eight copies of `c`, and then step through the region using word-level writes. You might find it helpful to do additional loop unrolling as well. On our reference machine, we were able to reduce the CPE from 1.00 for the straightforward implementation to 0.127. That is, the program is able to write 8 bytes every clock cycle.

Here are some additional guidelines. To ensure portability, let  $K$  denote the value of `sizeof (unsigned long)` for the machine on which you run your program.

- You may not call any library functions.

- Your code should work for arbitrary values of `n`, including when it is not a multiple of  $K$ . You can do this in a manner similar to the way we finish the last few iterations with loop unrolling.
- You should write your code so that it will compile and run correctly on any machine regardless of the value of  $K$ . Make use of the operation `sizeof` to do this.
- On some machines, unaligned writes can be much slower than aligned ones. (On some non-x86 machines, they can even cause segmentation faults.) Write your code so that it starts with byte-level writes until the destination address is a multiple of  $K$ , then do word-level writes, and then (if necessary) finish with byte-level writes.
- Beware of the case where `cnt` is small enough that the upper bounds on some of the loops become negative. With expressions involving the `sizeof` operator, the testing may be performed with unsigned arithmetic. (See [Section 2.2.8](#) and [Problem 2.72](#).)

## 5.18 ◆◆◆

We considered the task of polynomial evaluation in Practice Problems 5.5 and 5.6, with both a direct evaluation and an evaluation by Horner's method. Try to write faster versions of the function using the optimization techniques we have explored, including loop unrolling, parallel accumulation, and reassociation. You will find many different ways of mixing together Horner's scheme and direct evaluation with these optimization techniques.

Ideally, you should be able to reach a CPE close to the throughput limit of your machine. Our best version achieves a CPE of 1.07 on our reference machine.

## 5.19 ◆◆◆

In [Problem 5.12](#), we were able to reduce the CPE for the prefix-sum computation to 3.00, limited by the latency of floating-point addition on this machine. Simple loop unrolling does not improve things.

Using a combination of loop unrolling and reassociation, write code for a prefix sum that achieves a CPE less than the latency of floating-point addition on your machine. Doing this requires actually increasing the number of additions performed. For example, our version with two-way unrolling requires three additions per iteration, while our version with four-way unrolling requires five. Our best implementation achieves a CPE of 1.67 on our reference machine.

Determine how the throughput and latency limits of your machine limit the minimum CPE you can achieve for the prefix-sum operation.

# Solutions to Practice Problems

## Solution to Problem 5.1 [↗](#)(page 500)

This problem illustrates some of the subtle effects of memory aliasing.

As the following commented code shows, the effect will be to set the value at `xp` to zero:

```
4      *xp = *xp + *xp; /* 2x */
5      *xp = *xp - *xp; /* 2x-2x = 0 */
6      *xp = *xp - *xp; /* 0-0 = 0 */
```

This example illustrates that our intuition about program behavior can often be wrong. We naturally think of the case where `xp` and `yp` are distinct but overlook the possibility that they might be equal. Bugs often arise due to conditions the programmer does not anticipate.

## Solution to Problem 5.2 (page 504)

This problem illustrates the relationship between CPE and absolute performance. It can be solved using elementary algebra. We find that for  $n \leq 2$ , version 1 is the fastest. Version 2 is fastest for  $3 \leq n \leq 7$ , and version 3 is fastest for  $n \geq 8$ .

## Solution to Problem 5.3 (page 512)

This is a simple exercise, but it is important to recognize that the four statements of a `for` loop—initial, test, update, and body—get executed different numbers of times.

# Solution to Problem 5.4 (page 516)

This assembly code demonstrates a clever optimization opportunity detected by `gcc`. It is worth studying this code carefully to better understand the subtleties of code optimization.

- A. In the less optimized code, register `%xmm0` is simply used as a temporary value, both set and used on each loop iteration. In the more optimized code, it is used more in the manner of variable `acc` in `combine4`, accumulating the product of the vector elements. The difference with `combine4`, however, is that location `dest` is updated on each iteration by the second `vmovsd` instruction.

We can see that this optimized version operates much like the following C code:



```

1      /* Make sure dest updated on each iteration */
2      void combine3w(vec_ptr v, data_t *dest)
3      {
4          long i;
5          long length = vec_length(v);
6          data_t *data = get_vec_start(v);
7          data_t acc = IDENT;
8
9          /* Initialize in event length <= 0 */
10         *dest = ace;
11
12         for (i = 0; i < length; i++) {
13             acc = acc OP data[i];
14             *dest = ace;
15         }
16     }

```

- B. The two versions of `combine3` will have identical functionality, even with memory aliasing.
- C. This transformation can be made without changing the program behavior, because, with the exception of the first iteration, the value read from `dest` at the beginning of each iteration will be the same value written to this register at the end of the previous iteration. Therefore, the combining instruction can simply use the value already in `%xmm0` at the beginning of the loop.

# Solution to Problem 5.5 (page 530)

Polynomial evaluation is a core technique for solving many problems. For example, polynomial functions are commonly used to approximate trigonometric functions in math libraries.

- A. The function performs  $2n$  multiplications and  $n$  additions.
- B. We can see that the performance-limiting computation here is the repeated computation of the expression `xpwr = x * xpwr`. This requires a floating-point multiplication (5 clock cycles), and the computation for one iteration cannot begin until the one for the previous iteration has completed. The updating of `result` only requires a floating-point addition (3 clock cycles) between successive iterations.

# Solution to Problem 5.6 (page 530)

This problem demonstrates that minimizing the number of operations in a computation may not improve its performance.

- A. The function performs  $n$  multiplications and  $n$  additions, half the number of multiplications as the original function `poly`.
- B. We can see that the performance-limiting computation here is the repeated computation of the expression `result = a[i] + x*result`. Starting from the value of `result` from the previous iteration, we must first multiply it by `x` (5 clock cycles) and then add it to `a[i]` (3 cycles) before we have the value for this iteration. Thus, each iteration imposes a minimum latency of 8 cycles, exactly our measured CPE.
- C. Although each iteration in function `poly` requires two multiplications rather than one, only a single multiplication occurs along the critical path per iteration.

# Solution to Problem 5.7 [↗](#)(page 532)

The following code directly follows the rules we have stated for unrolling a loop by some factor  $k$ :

```

1 void unroll5(vec_ptr v, data_t *dest)
2 {
3     long i;
4     long length = vec_length(v);
5     long limit = length-4;
6     data_t *data = get_vec_start(v);
7     data_t acc = IDENT;
8
9     /* Combine 5 elements at a time */
10    for (i = 0; i < limit; i+=5) {
11        acc = acc OP data[i] OP data[i+1];
12        acc = acc OP data[i+2] OP data[i+3];
13        acc = acc OP data[i+4];
14    }
15
16    /* Finish any remaining elements */
17    for (;i < length; i++) {
18        acc = acc OP data[i];
19    }
20    *dest = ace;
21 }

```

## Solution to Problem 5.8 (page 545)

This problem demonstrates how small changes in a program can yield dramatic performance differences, especially on a machine with out-of-order execution. **Figure 5.39** diagrams the three multiplication operations for a single iteration of the function. In this figure, the operations shown as blue boxes are along the critical path—they need to be computed in sequence to compute a new value for loop variable  $r$ . The operations shown as light boxes can be computed in parallel with the critical path operations. For a loop with  $P$  operations along the critical path, each iteration will require a minimum of  $5P$  clock cycles and will compute the product for three elements, giving a lower bound on the CPE of  $5P/3$ . This implies lower bounds of 5.00 for A1, 3.33 for A2 and A5, and 1.67 for A3 and A4. We ran these functions on an Intel Core i7 Haswell processor and found that it could achieve these CPE values.

# Solution to Problem 5.9 (page 553)

This is another demonstration that a slight change in coding style can make it much easier for the compiler to detect opportunities to use conditional moves:

```
while (i1 < n && i2 < n) {  
    long v1 = src1 [i1];
```

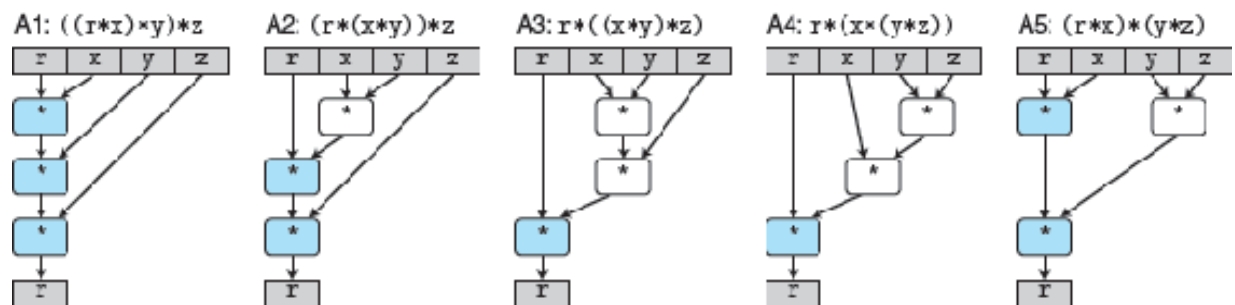


Figure 5.39 Data dependencies among multiplication operations for cases in Problem 5.8.

The operations shown as blue boxes form the critical paths for the iterations.

```
|  
    long v2 = src2 [i2];  
    long take1 = v1 < v2;  
    dest[id++] = take1 ? v1 : v2;  
    i1 += take1;  
    i2 += (1-take1);  
}
```

We measured a CPE of around 12.0 for this version of the code, a modest improvement over the original CPE of 15.0.



# Solution to Problem 5.10 (page 559)

This problem requires you to analyze the potential load-store interactions in a program.

- A. It will set each element `a[i]` to  $i + 1$ , for  $0 \leq i \leq 998$ .
- B. It will set each element `a[i]` to 0, for  $1 \leq i \leq 999$ .
- C. In the second case, the load of one iteration depends on the result of the store from the previous iteration. Thus, there is a write/read dependency between successive iterations.
- D. It will give a CPE of 1.2, the same as for Example A, since there are no dependencies between stores and subsequent loads.

# Solution to Problem 5.11 (page 561)

We can see that this function has a write/read dependency between successive iterations—the destination value `p[i]` on one iteration matches the source value `p[i-1]` on the next. A critical path is therefore formed for each iteration consisting of a store (from the previous iteration), a load, and a floating-point addition. The CPE measurement of 9.0 is consistent with our measurement of 7.3 for the CPE of `write_read` when there is a data dependency, since `write_read` involves an integer addition (1 clock-cycle latency), while `psum1` involves a floating-point addition (3 clock-cycle latency).

# Solution to Problem 5.12 (page 561)

Here is a revised version of the function:

```
1 void psum1a(float a[], float p[], long n)
2 {
3     long i;
4     /* last_val holds p[i-1]; val holds p [i] */
5     float last_val, val;
6     last_val = p[0] = a[0];
7     for (i = 1; i < n; i++) {
8         val = last_val + a[i];
9         p[i] = val;
10        last_val = val;
11    }
12 }
```

We introduce a local variable `last_val`. At the start of iteration `i`, it holds the value of `p[i-1]`. We then compute `val` to be the value of `p[i]` and to be the new value for `last_val`.

This version compiles to the following assembly code:

```

|
|   Inner loop of psum1a
|   a in %rdi, i in %rax, cnt in %rdx, last_val in %xmm0
1   .L16:                                loop:
2   vaddss (%rdi,%rax, 4), %xmm0, %xmm0   last_val = val
= last_val + a[i]
3   vmovss %xmm0, (%rsi,%rax,4)          Store val in
p[i]
4   addq $1, %rax                        Increment i
5   cmpq %rdx, 7, %rax                   Compare i :
cnt
6   jne .L16                             If !=, goto
loop

```

This code holds `last_val` in `%xmm0`, avoiding the need to read `p[i-1]` from memory and thus eliminating the write/read dependency seen in `psum1`.

---

# Chapter 6 The Memory Hierarchy

---

**6.1 Storage Technologies 581** 

**6.2 Locality 604** 

**6.3 The Memory Hierarchy 609** 

**6.4 Cache Memories 614** 

**6.5 Writing Cache-Friendly Code 633** 

**6.6 Putting It Together: The Impact of Caches on Program Performance 639** 

**6.7 Summary 648** 

**Bibliographic Notes 648** 

**Homework Problems 649** 

**Solutions to Practice Problems 660** 

*To this point in our study of systems, we have relied on a simple model of a computer system as a CPU that executes instructions and a memory system that holds instructions and data for the CPU. In our simple model, the memory system is a linear array of bytes, and the CPU can access each memory location in a constant amount of time. While this is an effective model up to a point, it does not reflect the way that modern systems really work.*

*In practice, a memory system is a hierarchy of storage devices with different capacities, costs, and access times. CPU registers hold the most frequently used data. Small, fast cache memories nearby the CPU act as staging areas for a subset of the data and instructions stored in the relatively slow main memory. The main memory stages data stored on large, slow disks, which in turn often serve as staging areas for data stored on the disks or tapes of other machines connected by networks.*

*Memory hierarchies work because well-written programs tend to access the storage at any particular level more frequently than they access the storage at the next lower level. So the*

*storage at the next level can be slower, and thus larger and cheaper per bit. The overall effect is a large pool of memory that costs as much as the cheap storage near the bottom of the hierarchy but that serves data to programs at the rate of the fast storage near the top of the hierarchy.*

*As a programmer, you need to understand the memory hierarchy because it has a big impact on the performance of your applications. If the data your program needs are stored in a CPU register, then they can be accessed in 0 cycles during the execution of the instruction. If stored in a cache, 4 to 75 cycles. If stored in main memory, hundreds of cycles. And if stored in disk, tens of millions of cycles!*

*Here, then, is a fundamental and enduring idea in computer systems: if you understand how the system moves data up and down the memory hierarchy, then you can write your application programs so that their data items are stored higher in the hierarchy, where the CPU can access them more quickly.*

*This idea centers around a fundamental property of computer programs known as*



*locality. Programs with good locality tend to access the same set of data items over and over again, or they tend to access sets of nearby data items. Programs with good locality tend to access more data items from the upper levels of the memory hierarchy than programs with poor locality, and thus run faster. For example, on our Core i7 system, the running times of different matrix multiplication kernels that perform the same number of arithmetic operations, but have different degrees of locality, can vary by a factor of almost 40!*

*In this chapter, we will look at the basic storage technologies—SRAM memory, DRAM memory, ROM memory, and rotating and solid state disks—and describe how they are organized into hierarchies. In particular, we focus on the cache memories that act as staging areas between the CPU and main memory, because they have the most impact on application program performance. We show you how to analyze your C programs for locality, and we introduce techniques for improving the locality in your programs. You will also learn an interesting way to characterize the performance of the memory hierarchy on a particular machine as a "memory*

*mountain" that shows read access times as a function of locality.*

[OceanofPDF.com](http://OceanofPDF.com)

## 6.1 Storage Technologies

Much of the success of computer technology stems from the tremendous progress in storage technology. Early computers had a few kilobytes of random access memory. The earliest IBM PCs didn't even have a hard disk. That changed with the introduction of the IBM PC-XT in 1982, with its 10-megabyte disk. By the year 2015, typical machines had 300,000 times as much disk storage, and the amount of storage was increasing by a factor of 2 every couple of years.

## 6.1.1 Random Access Memory

Random access memory (RAM) comes in two varieties—static and dynamic. Static RAM (SRAM) is faster and significantly more expensive than dynamic RAM (DRAM). SRAM is used for cache memories, both on and off the CPU chip. DRAM is used for the main memory plus the frame buffer of a graphics system. Typically, a desktop system will have no more than a few tens of megabytes of SRAM, but hundreds or thousands of megabytes of DRAM.

### Static RAM

SRAM stores each bit in a *bistable* memory cell. Each cell is implemented with a six-transistor circuit. This circuit has the property that it can stay indefinitely in either of two different voltage configurations, or *states*. Any other state will be unstable—starting from there, the circuit will quickly move toward one of the stable states. Such a memory cell is analogous to the inverted pendulum illustrated in [Figure 6.1](#).

The pendulum is stable when it is tilted either all the way to the left or all the way to the right. From any other position, the pendulum will fall to one side or the other. In principle, the pendulum could also remain balanced in a vertical position indefinitely, but this state is *metastable*—the smallest disturbance would make it start to fall, and once it fell it would never return to the vertical position.

Due to its bistable nature, an SRAM memory cell will retain its value indefinitely, as long as it is kept powered. Even when a disturbance, such as electrical noise, perturbs the voltages, the circuit will return to the stable value when the disturbance is removed.



**Figure 6.1 Inverted pendulum.**


Like an SRAM cell, the pendulum has only two stable configurations, or *states*.

**Figure 6.2 Characteristics of DRAM and SRAM memory.**

## *Dynamic RAM*

DRAM stores each bit as charge on a capacitor. This capacitor is very small— typically around 30 femtofarads—that is,  $30 \times 10^{-15}$  farads. Recall, however, that a farad is a very large unit of measure. DRAM storage can be made very dense—each cell consists of a capacitor and a single access transistor. Unlike SRAM, however, a DRAM memory cell is very sensitive to any disturbance. When the capacitor voltage is disturbed, it will never recover. Exposure to light rays will cause the capacitor voltages to change. In fact, the sensors in digital cameras and camcorders are essentially arrays of DRAM cells.

Various sources of leakage current cause a DRAM cell to lose its charge within a time period of around 10 to 100 milliseconds. Fortunately, for computers operating with clock cycle times measured in nanoseconds, this retention time is quite long. The memory system must periodically refresh every bit of memory by reading it out and then rewriting it. Some systems also use error-correcting codes, where the computer words are encoded using a few more bits (e.g., a 64-bit word might be encoded using 72 bits), such that circuitry can detect and correct any single erroneous bit within a word.

**Figure 6.2**  summarizes the characteristics of SRAM and DRAM memory. SRAM is persistent as long as power is applied. Unlike DRAM, no refresh is necessary. SRAM can be accessed faster than DRAM. SRAM is not sensitive to disturbances such as light and electrical noise. The trade-off is that SRAM cells use more transistors than DRAM cells and thus have lower densities, are more expensive, and consume more power.

## Conventional DRAMs

The cells (bits) in a DRAM chip are partitioned into  $d$  *supercells*, each consisting of  $w$  DRAM cells.  $Ad \times w$  DRAM stores a total of  $dw$  bits of information. The supercells are organized as a rectangular array with  $r$  rows and  $c$  columns, where  $rc = d$ . Each supercell has an address of the form  $(i, j)$ , where  $i$  denotes the row and  $j$  denotes the column.

For example, [Figure 6.3](#) shows the organization of a  $16 \times 8$  DRAM chip with  $d = 16$  supercells,  $w = 8$  bits per supercell,  $r = 4$  rows, and  $c = 4$  columns. The shaded box denotes the supercell at address  $(2,1)$ . Information flows in and out of the chip via external connectors called *pins*. Each pin carries a 1-bit signal. [Figure 6.3](#) shows two of these sets of pins: eight data pins that can transfer 1 byte

### Aside A note on terminology

The storage community has never settled on a standard name for a DRAM array element. Computer architects tend to refer to it as a "cell," overloading the term with the DRAM storage cell. Circuit designers tend to refer to it as a "word," overloading the term with a word of main memory. To avoid confusion, we have adopted the unambiguous term "supercell."

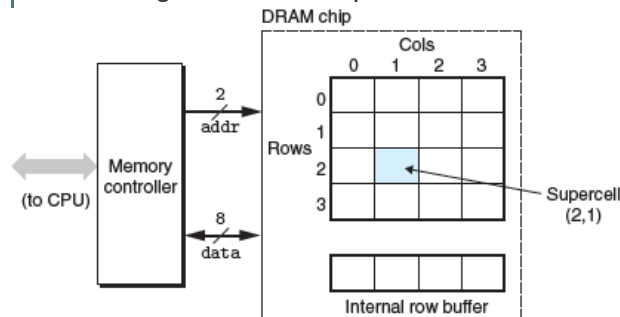


Figure 6.3 High-level view of a 128-bit  $16 \times 8$  DRAM chip.

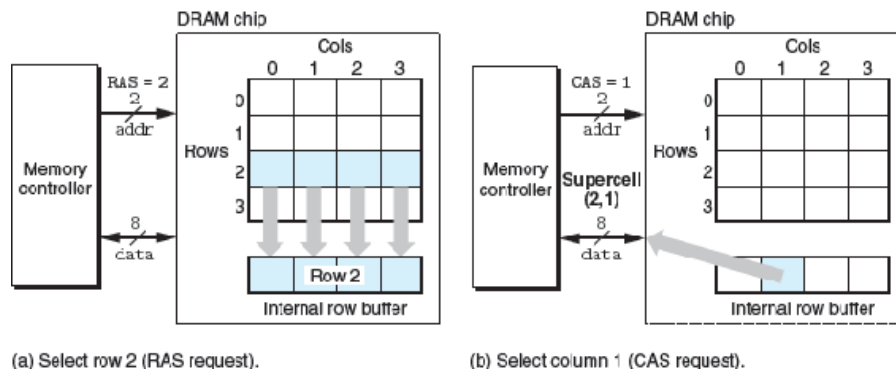
in or out of the chip, and two `addr` pins that carry two-bit row and column supercell addresses. Other pins that carry control information are not shown.

Each DRAM chip is connected to some circuitry, known as the *memory controller*, that can transfer  $w$  bits at a time to and from each DRAM chip. To read the contents of supercell  $(i, j)$ , the memory controller sends the row address  $i$  to the DRAM, followed by the column address  $j$ . The DRAM responds by sending the contents of supercell  $(i, j)$  back to the controller. The row address  $i$  is called a *RAS (row access strobe) request*. The column address  $j$  is called a

CAS (*column access strobe*) request. Notice that the RAS and CAS requests share the same DRAM address pins.

For example, to read supercell (2,1) from the  $16 \times 8$  DRAM in [Figure 6.3](#), the memory controller sends row address 2, as shown in [Figure 6.4\(a\)](#). The DRAM responds by copying the entire contents of row 2 into an internal row buffer. Next, the memory controller sends column address 1, as shown in [Figure 6.4\(b\)](#). The DRAM responds by copying the 8 bits in supercell (2,1) from the row buffer and sending them to the memory controller.

One reason circuit designers organize DRAMs as two-dimensional arrays instead of linear arrays is to reduce the number of address pins on the chip. For example, if our example 128-bit DRAM were organized as a linear array of 16 supercells with addresses 0 to 15, then the chip would need four address pins instead of two. The disadvantage of the two-dimensional array organization is that addresses must be sent in two distinct steps, which increases the access time.



**Figure 6.4** Reading the contents of a DRAM supercell.

## Memory Modules

DRAM chips are packaged in *memory modules* that plug into expansion slots on the main system board (motherboard). Core i7 systems use the 240-pin *dual inline memory module (DIMM)*, which transfers data to and from the memory controller in 64-bit chunks.

**Figure 6.5** shows the basic idea of a memory module. The example module stores a total of 64 MB (megabytes) using eight 64-Mbit  $8M \times 8$  DRAM chips, numbered 0 to 7. Each supercell stores 1 byte of *main memory*, and each 64-bit word at byte address  $A$  in main memory is represented by the eight supercells whose corresponding supercell address is  $(i, j)$ . In the example in **Figure 6.5**, DRAM 0 stores the first (lower-order) byte, DRAM 1 stores the next byte, and so on.

To retrieve the word at memory address  $A$ , the memory controller converts  $A$  to a supercell address  $(i, j)$  and sends it to the memory module, which then broadcasts  $i$  and  $j$  to each DRAM. In response, each DRAM outputs the 8-bit contents of its  $(i, j)$  supercell. Circuitry in the module collects these outputs and forms them into a 64-bit word, which it returns to the memory controller.

Main memory can be aggregated by connecting multiple memory modules to the memory controller. In this case, when the controller receives an address  $A$ , the controller selects the module  $k$  that contains  $A$ , converts  $A$  to its  $(i, j)$  form, and sends  $(i, j)$  to module  $k$ .



## Practice Problem 6.1 (solution page 660)

In the following, let  $r$  be the number of rows in a DRAM array,  $c$  the number of columns,  $b_r$  the number of bits needed to address the rows, and  $b_c$  the number of bits needed to address the columns. For each of the following DRAMs, determine the power-of-2 array dimensions that minimize  $\max(b_r, b_c)$ , the maximum number of bits needed to address the rows or columns of the array.

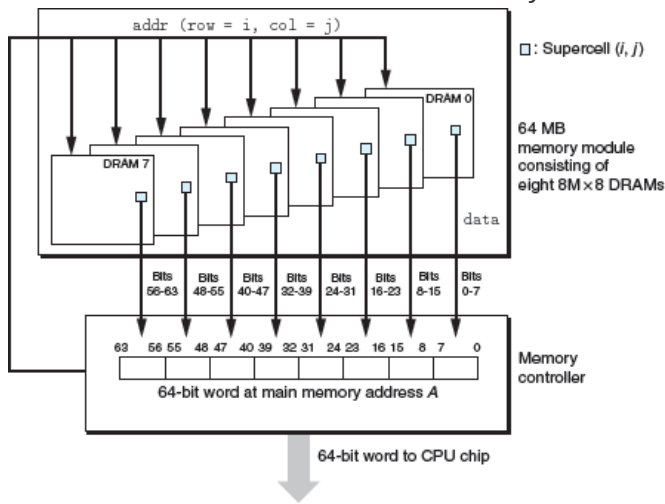


Figure 6.5 Reading the contents of a memory module.

## *Enhanced DRAMs*

There are many kinds of DRAM memories, and new kinds appear on the market with regularity as manufacturers attempt to keep up with rapidly increasing processor speeds. Each is based on the conventional DRAM cell, with optimizations that improve the speed with which the basic DRAM cells can be accessed.

**Fast page mode DRAM (FPM DRAM).** A conventional DRAM copies an entire row of supercells into its internal row buffer, uses one, and then discards the rest. FPM DRAM improves on this by allowing consecutive accesses to the same row to be served directly from the row buffer. For example, to read four supercells from row  $i$  of a conventional DRAM, the memory controller must send four RAS/CAS requests, even though the row address  $i$  is identical in each case. To read supercells from the same row of an FPM DRAM, the memory controller sends an initial RAS/CAS request, followed by three CAS requests. The initial RAS/CAS request copies row  $i$  into the row buffer and returns the supercell addressed by the CAS. The next three supercells are served directly from the row buffer, and thus are returned more quickly than the initial supercell.

**Extended data out DRAM (EDO DRAM).** An enhanced form of FPM DRAM that allows the individual CAS signals to be spaced closer together in time.

**Synchronous DRAM (SDRAM).** Conventional, FPM, and EDO DRAMs are asynchronous in the sense that they communicate with the memory controller using a set of explicit control signals. SDRAM replaces many of these control signals with the rising edges of the same external clock signal that drives the memory controller. Without going into detail, the net effect is that an SDRAM can output the contents of its supercells at a faster rate than its asynchronous counterparts.

**Double Data-Rate Synchronous DRAM (DDR SDRAM).** DDR SDRAM is an enhancement of SDRAM that doubles the speed of the DRAM by using both clock edges as control signals. Different types of DDR SDRAMs are characterized by the size of a small prefetch buffer that increases the effective bandwidth: DDR (2 bits), DDR2 (4 bits), and DDR3 (8 bits).

**Video RAM (VRAM).** Used in the frame buffers of graphics systems. VRAM is similar in spirit to FPM DRAM. Two major differences are that (1) VRAM output is produced by shifting the entire contents of the internal buffer in sequence and (2) VRAM allows concurrent reads and writes to the memory. Thus, the system can be painting the screen with the pixels in the frame buffer (reads) while concurrently writing new values for the next update (writes).

## Nonvolatile Memory

DRAMs and SRAMs are *volatile* in the sense that they lose their information if the supply voltage is turned off. *Nonvolatile memories*, on the other hand, retain their information even when they are powered off. There are a variety of nonvolatile memories. For historical reasons, they are referred to collectively as *read-only memories* (ROMs), even though some types of ROMs can be written to as well as read. ROMs are distinguished by the number of times they can be reprogrammed (written to) and by the mechanism for reprogramming them.

### Aside Historical popularity of DRAM technologies

Until 1995, most PCs were built with FPM DRAMs. From 1996 to 1999, EDO DRAMs dominated the market, while FPM DRAMs all but disappeared. SDRAMs first appeared in 1995 in high-end systems, and by 2002 most PCs were built with SDRAMs and DDR SDRAMs. By 2010, most server and desktop systems were built with DDR3 SDRAMs. In fact, the Intel Core i7 supports only DDR3 SDRAM.

A *programmable ROM (PROM)* can be programmed exactly once. PROMs include a sort of fuse with each memory cell that can be blown once by zapping it with a high current.

An *erasable programmable ROM (EPROM)* has a transparent quartz window that permits light to reach the storage cells. The EPROM cells are cleared to zeros by shining ultraviolet light through the window. Programming an EPROM is done by using a special device to write ones into the EPROM. An EPROM can be erased and reprogrammed on the order of 1,000 times. An *electrically erasable PROM (EEPROM)* is akin to an EPROM, but it does not require a physically separate programming device, and thus can be reprogrammed in-place on printed circuit cards. An EEPROM can be reprogrammed on the order of  $10^5$  times before it wears out.

*Flash memory* is a type of nonvolatile memory, based on EEPROMs, that has become an important storage technology. Flash memories are everywhere, providing fast and durable nonvolatile storage for a slew of electronic devices, including digital cameras, cell phones, and music players, as well as laptop, desktop, and server computer systems. In [Section 6.1.3](#), we will look in detail at a new form of flash-based disk drive, known as a *solid state disk (SSD)*, that provides a faster, sturdier, and less power-hungry alternative to conventional rotating disks.


Programs stored in ROM devices are often referred to as *firmware*. When a computer system is powered up, it runs firmware stored in a ROM. Some systems provide a small set of

primitive input and output functions in firmware—for example, a PC's BIOS (basic input/output system) routines. Complicated devices such as graphics cards and disk drive controllers also rely on firmware to translate I/O (input/output) requests from the CPU.


## Accessing Main Memory

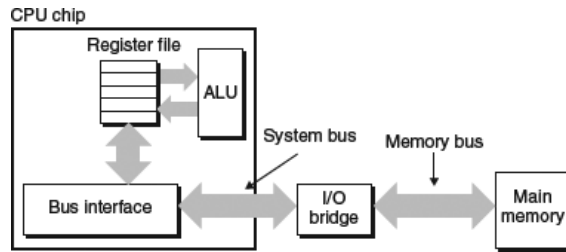
Data flows back and forth between the processor and the DRAM main memory over shared electrical conduits called *buses*. Each transfer of data between the CPU and memory is accomplished with a series of steps called a *bus transaction*. A *read transaction* transfers data from the main memory to the CPU. A *write transaction* transfers data from the CPU to the main memory.

A *bus* is a collection of parallel wires that carry address, data, and control signals. Depending on the particular bus design, data and address signals can share the same set of wires or can use different sets. Also, more than two devices can share the same bus. The control wires carry signals that synchronize the transaction and identify what kind of transaction is currently being performed. For example, is this transaction of interest to the main memory, or to some other I/O device such as a disk controller? Is the transaction a read or a write? Is the information on the bus an address or a data item?

**Figure 6.6**  shows the configuration of an example computer system. The main components are the CPU chip, a chipset that we will call an *I/O bridge* (which includes the memory controller), and the DRAM memory modules that make up main memory. These components are connected by a pair of buses: a *system bus* that connects the CPU to the I/O bridge, and a *memory bus* that connects the I/O

### Aside A note on bus designs

Bus design is a complex and rapidly changing aspect of computer systems. Different vendors develop different bus architectures as a way to differentiate their products. For example, some Intel systems use chipsets known as the *northbridge* and the *southbridge* to connect the CPU to memory and I/O devices, respectively. In older Pentium and Core 2 systems, a *front side bus* (FSB) connects the CPU to the northbridge. Systems from AMD replace the FSB with the *HyperTransport* interconnect, while newer Intel Core i7 systems use the *QuickPath* interconnect. The details of these different bus architectures are beyond the scope of this text. Instead, we will use the high-level bus architecture from **Figure 6.6**  as a running example throughout. It is a simple but useful abstraction that allows us to be concrete. It captures the main ideas without being tied too closely to the detail of any proprietary designs.



**Figure 6.6** Example bus structure that connects the CPU and main memory.

bridge to the main memory. The I/O bridge translates the electrical signals of the system bus into the electrical signals of the memory bus. As we will see, the I/O bridge also connects the system bus and memory bus to an *I/O bus* that is shared by I/O devices such as disks and graphics cards. For now, though, we will focus on the memory bus.

Consider what happens when the CPU performs a load operation such as

```
movq A,%rax
```

where the contents of address *A* are loaded into register `%rax`. Circuitry on the CPU chip called the *bus interface* initiates a read transaction on the bus. The read transaction consists of three steps. First, the CPU places the address *A* on the system bus. The I/O bridge passes the signal along to the memory bus (**Figure 6.7(a)**). Next, the main memory senses the address signal on the memory bus, reads the address from the memory bus, fetches the data from the DRAM, and writes the data to the memory bus. The I/O bridge translates the memory bus signal into a system bus signal and passes it along to the system bus (**Figure 6.7(b)**). Finally, the CPU senses the data on the system bus, reads the data from the bus, and copies the data to register `%rax` (**Figure 6.7(c)**).

Conversely, when the CPU performs a store operation such as

```
movq %rax,A
```

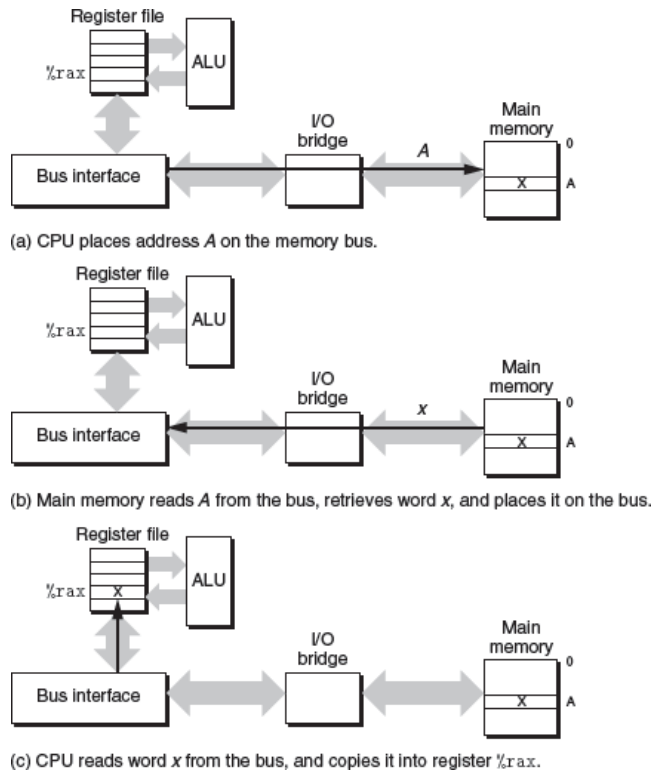


Figure 6.7 Memory read transaction for a load operation: `movq A, %rax.`

where the contents of register `%rax` are written to address `A`, the CPU initiates a write transaction. Again, there are three basic steps. First, the CPU places the address on the system bus. The memory reads the address from the memory bus and waits for the data to arrive (Figure 6.8(a)). Next, the CPU copies the data in `%rax` to the system bus (Figure 6.8(b)). Finally, the main memory reads the data from the memory bus and stores the bits in the DRAM (Figure 6.8(c)).

## 6.1.2 Disk Storage

*Disks* are workhorse storage devices that hold enormous amounts of data, on the order of hundreds to thousands of gigabytes, as opposed to the hundreds or thousands of megabytes in a RAM-based memory. However, it takes on the order of milliseconds to read information from a disk, a hundred thousand times longer than from DRAM and a million times longer than from SRAM.

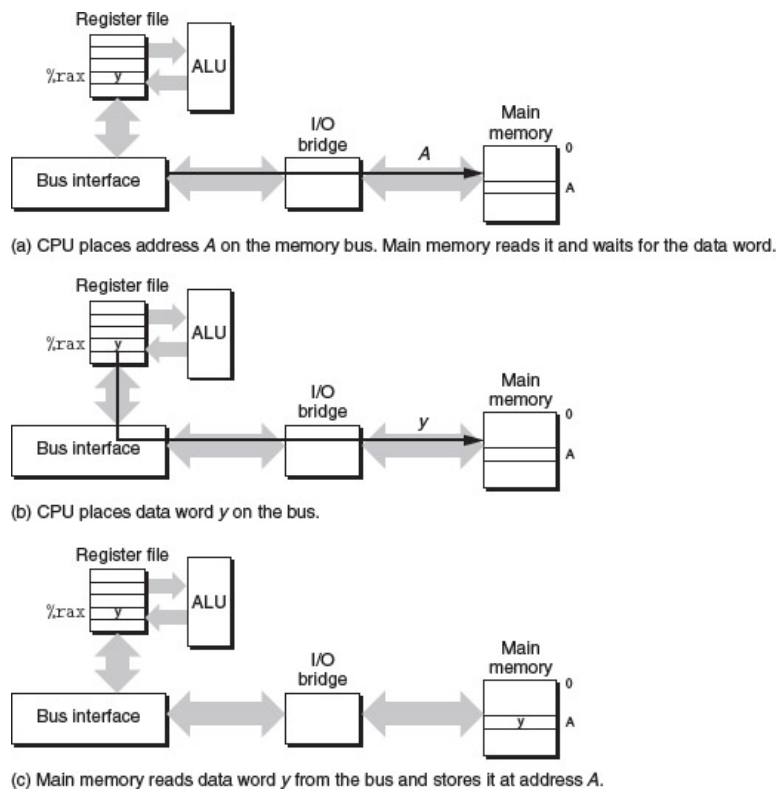
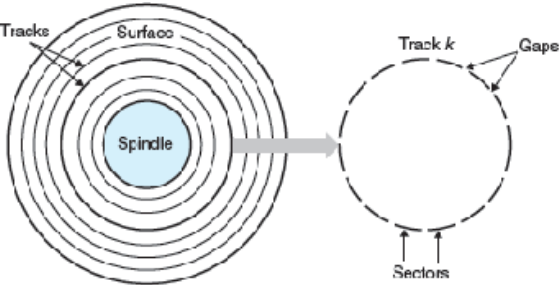


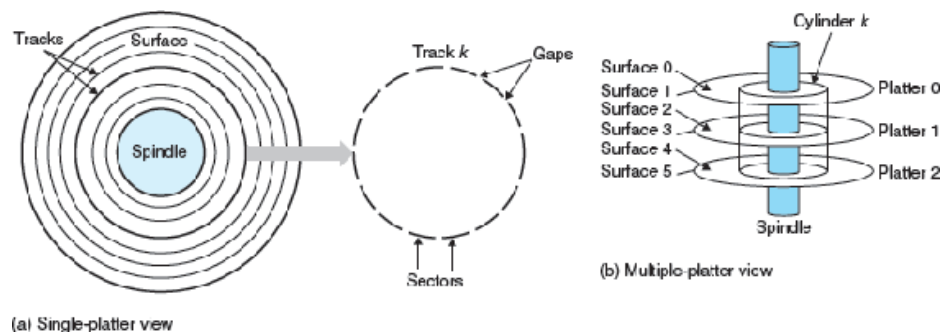
Figure 6.8 Memory write transaction for a store operation: `movq %rax, A.`



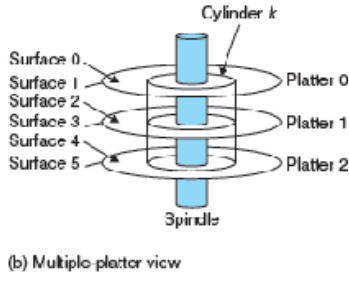
## Disk Geometry

Disks are constructed from *platters*. Each platter consists of two sides, or *surfaces*, that are coated with magnetic recording material. A rotating *spindle* in the center of the platter spins the platter at a fixed *rotational rate*, typically between 5,400 and 15,000 *revolutions per minute (RPM)*. A disk will typically contain one or more of these platters encased in a sealed container.

**Figure 6.9(a)**  shows the geometry of a typical disk surface. Each surface consists of a collection of concentric rings called *tracks*. Each track is partitioned into a collection of *sectors*. Each sector contains an equal number of data bits (typically 512 bytes) encoded in the magnetic material on the sector. Sectors are separated by *gaps* where no data bits are stored. Gaps store formatting bits that identify sectors.



**Figure 6.9** Disk geometry.

A disk consists of one or more platters stacked on top of each other and encased in a sealed package, as shown in **Figure 6.9(b)** . The entire assembly is often referred to as a *disk drive*, although we will usually refer to it as simply a *disk*. We will sometimes refer to disks as *rotating disks* to distinguish them from flash-based solid state disks (SSDs), which have no moving parts.

Disk manufacturers describe the geometry of multiple-platter drives in terms of *cylinders*, where a cylinder is the collection of tracks on all the surfaces that are equidistant from the center of the spindle. For example, if a drive has three platters and six surfaces, and the tracks on each surface are numbered consistently, then cylinder  $k$  is the collection of the six instances of track  $k$ .

## Disk Capacity

The maximum number of bits that can be recorded by a disk is known as its *maximum capacity*, or simply *capacity*. Disk capacity is determined by the following technology factors:

*Recording density* (bits/in). The number of bits that can be squeezed into a 1-inch segment of a track.

*Track density* (tracks/in). The number of tracks that can be squeezed into a 1-inch segment of the radius extending from the center of the platter.

*Areal density* (bits/in<sup>2</sup>). The product of the recording density and the track density.

Disk manufacturers work tirelessly to increase areal density (and thus capacity), and this is doubling every couple of years. The original disks, designed in an age of low areal density, partitioned every track into the same number of sectors, which was determined by the number of sectors that could be recorded on the innermost track. To maintain a fixed number of sectors per track, the sectors were spaced farther apart on the outer tracks. This was a reasonable approach

### Aside How much is a gigabyte?

Unfortunately, the meanings of prefixes such as kilo (K), mega (M), giga (G), and tera (T) depend on the context. For measures that relate to the capacity of DRAMs and SRAMs, typically  $K = 2^{10}$ ,  $M = 2^{20}$ ,  $G = 2^{30}$ , and  $T = 2^{40}$ . For measures related to the capacity of I/O devices such as disks and networks, typically  $K = 10^3$ ,  $M = 10^6$ ,  $G = 10^9$ , and  $T = 10^{12}$ . Rates and throughputs usually use these prefix values as well.

Fortunately, for the back-of-the-envelope estimates that we typically rely on, either assumption works fine in practice. For example, the relative difference between  $2^{30}$  and  $10^9$  is not that large:  $(2^{30} - 10^9)/10^9 \approx 7\%$ . Similarly,  $(2^{40} - 10^{12})/10^{12} \approx 10\%$ .

when areal densities were relatively low. However, as areal densities increased, the gaps between sectors (where no data bits were stored) became unacceptably large. Thus, modern high-capacity disks use a technique known as *multiple zone recording*, where the set of cylinders is partitioned into disjoint subsets known as *recording zones*. Each zone consists of a contiguous collection of cylinders. Each track in each cylinder in a zone has the same number of sectors, which is determined by the number of sectors that can be packed into the innermost track of the zone.

The capacity of a disk is given by the following formula:

$$\text{Capacity} = \frac{\# \text{ bytes}}{\text{sector}} \times \frac{\text{average } \# \text{ sectors}}{\text{track}} \times \frac{\# \text{ tracks}}{\text{surface}} \times \frac{\# \text{ surfaces}}{\text{platter}} \times \frac{\# \text{ platters}}{\text{disk}}$$

For example, suppose we have a disk with five platters, 512 bytes per sector, 20,000 tracks per surface, and an average of 300 sectors per track. Then the capacity of the disk is

$$\begin{aligned} \text{Capacity} &= \frac{512 \text{ bytes}}{\text{sector}} \times \frac{300 \text{ sectors}}{\text{track}} \times \frac{20,000 \text{ tracks}}{\text{surface}} \times \frac{2 \text{ surfaces}}{\text{platter}} \times \frac{5 \text{ platters}}{\text{disk}} \\ &= 30,720,000,000 \text{ bytes} \\ &= 30.72 \text{ GB} \end{aligned}$$

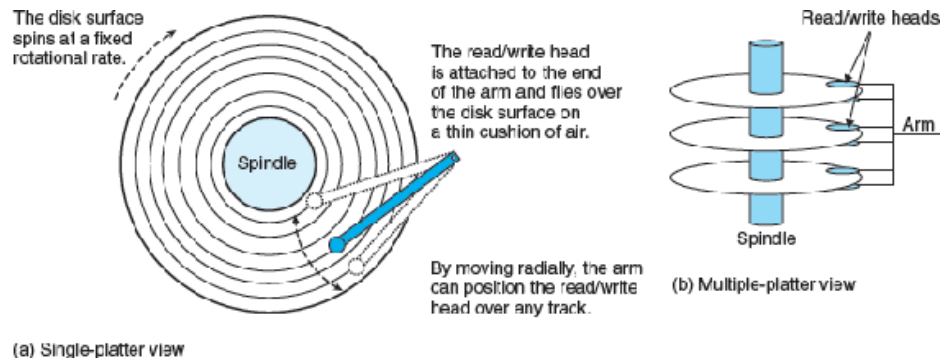
Notice that manufacturers express disk capacity in units of gigabytes (GB) or terabytes (TB), where 1 GB =  $10^9$  bytes and 1 TB =  $10^{12}$  bytes.

## Practice Problem 6.2 (solution page [661](#))

What is the capacity of a disk with 2 platters, 10,000 cylinders, an average of 400 sectors per track, and 512 bytes per sector?

## Disk Operation

Disks read and write bits stored on the magnetic surface using a *read/write head* connected to the end of an *actuator arm*, as shown in [Figure 6.10\(a\)](#). By moving



**Figure 6.10** Disk dynamics.

the arm back and forth along its radial axis, the drive can position the head over any track on the surface. This mechanical motion is known as a *seek*. Once the head is positioned over the desired track, then, as each bit on the track passes underneath, the head can either sense the value of the bit (read the bit) or alter the value of the bit (write the bit). Disks with multiple platters have a separate read/write head for each surface, as shown in [Figure 6.10\(b\)](#). The heads are lined up vertically and move in unison. At any point in time, all heads are positioned on the same cylinder.

The read/write head at the end of the arm flies (literally) on a thin cushion of air over the disk surface at a height of about 0.1 microns and a speed of about 80 km/h. This is analogous to placing a skyscraper on its side and flying it around the world at a height of 2.5 cm (1 inch) above the ground, with each orbit of the earth taking only 8 seconds! At these tolerances, a tiny piece of dust on the surface is like a huge boulder. If the head were to strike one of these boulders, the head would cease flying and crash into the surface (a so-called head crash). For this reason, disks are always sealed in airtight packages.

Disks read and write data in sector-size blocks. The *access time* for a sector has three main components: *seek time*, *rotational latency*, and *transfer time*:

**Seek time.** To read the contents of some target sector, the arm first positions the head over the track that contains the target sector. The time required to move the arm is called the *seek time*. The seek time,  $T_{\text{seek}}$ , depends on the previous position of the head and the speed that the arm moves across the surface. The average seek time in modern drives,

$T_{\text{avg seek}}$ , measured by taking the mean of several thousand seeks to random sectors, is typically on the order of 3 to 9 ms. The maximum time for a single seek,  $T_{\text{max seek}}$ , can be as high as 20 ms.

**Rotational latency.** Once the head is in position over the track, the drive waits for the first bit of the target sector to pass under the head. The performance of this step depends on both the position of the surface when the head arrives at the target track and the rotational speed of the disk. In the worst case, the head just misses the target sector and waits for the disk to make a full rotation. Thus, the maximum rotational latency, in seconds, is given by

$$T_{\text{max rotation}} = \frac{1}{\text{RPM}} \times \frac{60 \text{ secs}}{1 \text{ min}}$$

The average rotational latency,  $T_{\text{avg rotation}}$ , is simply half of  $T_{\text{max rotation}}$ .

**Transfer time.** When the first bit of the target sector is under the head, the drive can begin to read or write the contents of the sector. The transfer time for one sector depends on the rotational speed and the number of sectors per track. Thus, we can roughly estimate the average transfer time for one sector in seconds as

$$T_{\text{avg transfer}} = \frac{1}{\text{RPM}} \times \frac{1}{(\text{average \# sectors/track})} \times \frac{60 \text{ secs}}{1 \text{ min}}$$

We can estimate the average time to access the contents of a disk sector as the sum of the average seek time, the average rotational latency, and the average transfer time. For example, consider a disk with the following parameters:

For this disk, the average rotational latency (in ms) is

$$\begin{aligned} T_{\text{avg rotation}} &= 1/2 \times T_{\text{max rotation}} \\ &= 1/2 \times (60 \text{ sec s}/7,200 \text{ RPM}) \times 1,000 \text{ ms/sec} \\ &\approx 4 \text{ ms} \end{aligned}$$

The average transfer time is

$$\begin{aligned} T_{\text{avg rotation}} &= 60/7,200 \text{ RPM} \times 1/400 \text{ sectors/track} \times 1,000 \text{ ms/sec} \\ &\approx 0.02 \text{ ms} \end{aligned}$$

Putting it all together, the total estimated access time is

$$\begin{aligned}T_{\text{access}} &= T_{\text{avg seek}} + T_{\text{avg rotation}} + T_{\text{avg transfer}} \\ &= 9 \text{ ms} + 4 \text{ ms} + 0.02 \text{ ms} \\ &= 13.02 \text{ ms}\end{aligned}$$

This example illustrates some important points:

- The time to access the 512 bytes in a disk sector is dominated by the seek time and the rotational latency. Accessing the first byte in the sector takes a long time, but the remaining bytes are essentially free.
- Since the seek time and rotational latency are roughly the same, twice the seek time is a simple and reasonable rule for estimating disk access time.
- The access time for a 64-bit word stored in SRAM is roughly 4 ns, and 60 ns for DRAM. Thus, the time to read a 512-byte sector-size block from memory is roughly 256 ns for SRAM and 4,000 ns for DRAM. The disk access time, roughly 10 ms, is about 40,000 times greater than SRAM, and about 2,500 times greater than DRAM.

### Practice Problem 6.3 (solution page [661](#))

Estimate the average time (in ms) to access a sector on the following disk:

## *Logical Disk Blocks*

As we have seen, modern disks have complex geometries, with multiple surfaces and different recording zones on those surfaces. To hide this complexity from the operating system, modern disks present a simpler view of their geometry as a sequence of  $B$  sector-size *logical blocks*, numbered  $0, 1, \dots, B - 1$ . A small hardware/firmware device in the disk package, called the *disk controller*, maintains the mapping between logical block numbers and actual (physical) disk sectors.

When the operating system wants to perform an I/O operation such as reading a disk sector into main memory, it sends a command to the disk controller asking it to read a particular logical block number. Firmware on the controller performs a fast table lookup that translates the logical block number into a (*surface, track, sector*) triple that uniquely identifies the corresponding physical sector. Hardware on the controller interprets this triple to move the heads to the appropriate cylinder, waits for the sector to pass under the head, gathers up the bits sensed by the head into a small memory buffer on the controller, and copies them into main memory.

## Practice Problem 6.4 (solution page [661](#))

Suppose that a 1 MB file consisting of 512-byte logical blocks is stored on a disk drive with the following characteristics:

### Aside Formatted disk capacity

Before a disk can be used to store data, it must be *formatted* by the disk controller. This involves filling in the gaps between sectors with information that identifies the sectors, identifying any cylinders with surface defects and taking them out of action, and setting aside a set of cylinders in each zone as spares that can be called into action if one or more cylinders in the zone goes bad during the lifetime of the disk. The *formatted capacity* quoted by disk manufacturers is less than the maximum capacity because of the existence of these spare cylinders.

For each case below, suppose that a program reads the logical blocks of the file sequentially, one after the other, and that the time to position the head over the first block is  $T_{\text{avg seek}} + T_{\text{avg rotation}}$ .

- A. **Best case:** Estimate the optimal time (in ms) required to read the file given the best possible mapping of logical blocks to disk sectors (i.e., sequential).
- B. **Random case:** Estimate the time (in ms) required to read the file if blocks are mapped randomly to disk sectors.

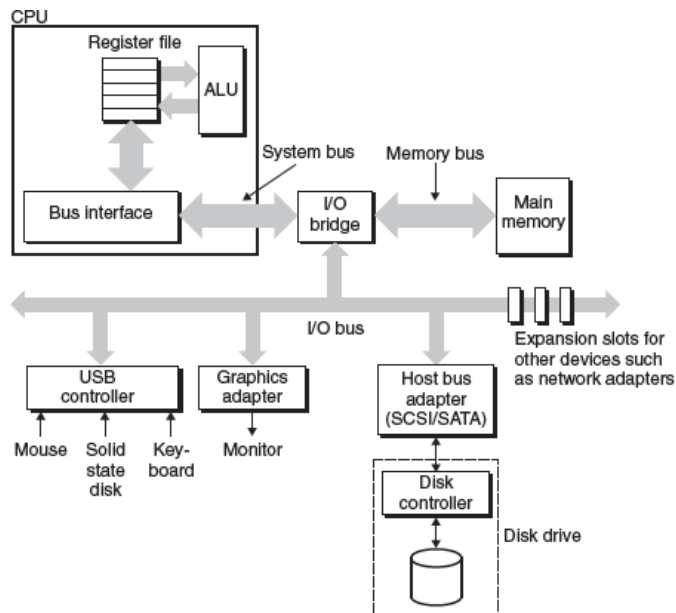


## Connecting I/O Devices

Input/output (I/O) devices such as graphics cards, monitors, mice, keyboards, and disks are connected to the CPU and main memory using an *I/O bus*. Unlike the system bus and memory buses, which are CPU-specific, I/O buses are designed to be independent of the underlying CPU. [Figure 6.11](#) shows a representative I/O bus structure that connects the CPU, main memory, and I/O devices.

Although the I/O bus is slower than the system and memory buses, it can accommodate a wide variety of third-party I/O devices. For example, the bus in [Figure 6.11](#) has three different types of devices attached to it.

- A *Universal Serial Bus (USB)* controller is a conduit for devices attached to a USB bus, which is a wildly popular standard for connecting a variety of peripheral I/O devices, including keyboards, mice, modems, digital cameras, game controllers, printers, external disk drives, and solid state disks. USB 3.0 buses have a maximum bandwidth of 625 MB/s. USB 3.1 buses have a maximum bandwidth of 1,250 MB/s.



**Figure 6.11** Example bus structure that connects the CPU, main memory, and I/O devices.

- A *graphics card (or adapter)* contains hardware and software logic that is responsible for painting the pixels on the display monitor on behalf of the CPU.
- A *host bus adapter* that connects one or more disks to the I/O bus using a communication protocol defined by a particular *host bus interface*. The two most popular such interfaces

for disks are *SCSI* (pronounced "scuzzy") and *SATA* (pronounced "sat-uh"). SCSI disks are typically faster and more expensive than SATA drives. A SCSI host bus adapter (often called a *SCSI controller*) can support multiple disk drives, as opposed to SATA adapters, which can only support one drive.

Additional devices such as *network adapters* can be attached to the I/O bus by plugging the adapter into empty *expansion slots* on the motherboard that provide a direct electrical connection to the bus.

## Accessing Disks

While a detailed description of how I/O devices work and how they are programmed is outside our scope here, we can give you a general idea. For example, [Figure 6.12](#) summarizes the steps that take place when a CPU reads data from a disk.


### Aside Advances in I/O bus designs


The I/O bus in [Figure 6.11](#) is a simple abstraction that allows us to be concrete, without being tied too closely to the details of any specific system. It is based on the *peripheral component interconnect (PCI)* bus, which was popular until around 2010. In the PCI model, each device in the system shares the bus, and only one device at a time can access these wires. In modern systems, the shared PCI bus has been replaced by a *PCI express (PCIe)* bus, which is a set of high-speed serial, point-to-point links connected by switches, akin to the switched Ethernets that you will learn about in [Chapter 11](#). A PCIe bus, with a maximum throughput of 16 GB/s, is an order of magnitude faster than a PCI bus, which has a maximum throughput of 533 MB/s. Except for measured I/O performance, the differences between the different bus designs are not visible to application programs, so we will use the simple shared bus abstraction throughout the text.

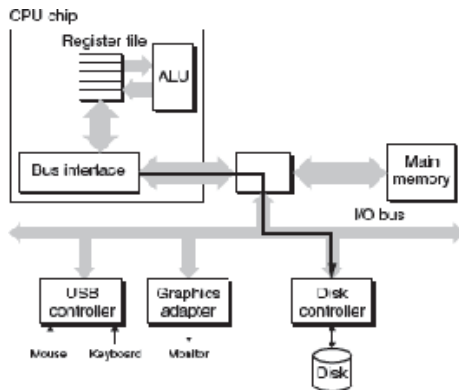
The CPU issues commands to I/O devices using a technique called *memory-mapped I/O* ([Figure 6.12\(a\)](#)). In a system with memory-mapped I/O, a block of addresses in the address space is reserved for communicating with I/O devices. Each of these addresses is known as an *I/O port*. Each device is associated with (or mapped to) one or more ports when it is attached to the bus.

As a simple example, suppose that the disk controller is mapped to port `0xa0`. Then the CPU might initiate a disk read by executing three store instructions to address `0xa0`: The first of these instructions sends a command word that tells the disk to initiate a read, along with other parameters such as whether to interrupt the CPU when the read is finished. (We will discuss interrupts in [Section 8.1](#).) The second instruction indicates the logical block number that should be read. The third instruction indicates the main memory address where the contents of the disk sector should be stored.

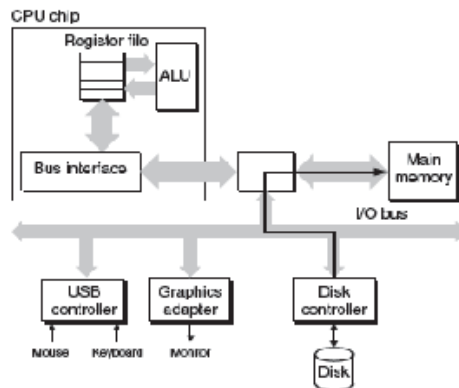
After it issues the request, the CPU will typically do other work while the disk is performing the read. Recall that a 1 GHz processor with a 1 ns clock cycle can potentially execute 16 million instructions in the 16 ms it takes to read the disk. Simply waiting and doing nothing while the transfer is taking place would be enormously wasteful.

After the disk controller receives the read command from the CPU, it translates the logical block number to a sector address, reads the contents of the sector, and transfers the contents directly to main memory, without any intervention from the CPU (**Figure 6.12(b)** ). This process, whereby a device performs a read or write bus transaction on its own, without any involvement of the CPU, is known as *direct memory access* (DMA). The transfer of data is known as a *DMA transfer*.

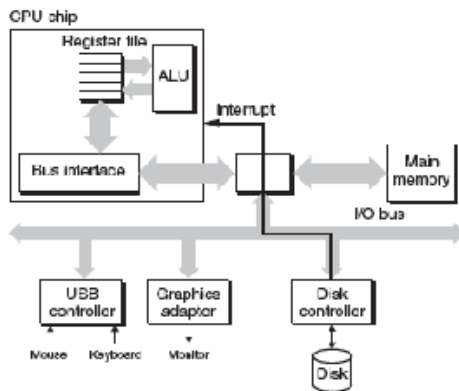
After the DMA transfer is complete and the contents of the disk sector are safely stored in main memory, the disk controller notifies the CPU by sending an interrupt signal to the CPU (**Figure 6.12(c)** ). The basic idea is that an interrupt signals an external pin on the CPU chip. This causes the CPU to stop what it is currently working on and jump to an operating system routine. The routine records the fact that the I/O has finished and then returns control to the point where the CPU was interrupted.



(a) The CPU initiates a disk read by writing a command, logical block number, and destination memory address to the memory-mapped address associated with the disk.



(b) The disk controller reads the sector and performs a DMA transfer into main memory.



(c) When the DMA transfer is complete, the disk controller notifies the CPU with an interrupt.

Figure 6.12 Reading a disk sector.

## Aside Characteristics of a commercial disk drive

Disk manufacturers publish a lot of useful high-level technical information on their Web sites. For example, the Seagate Web site contains the following information (and much more!) about one of their popular drives, the Barracuda 7400. ([Seagate.com](http://Seagate.com))

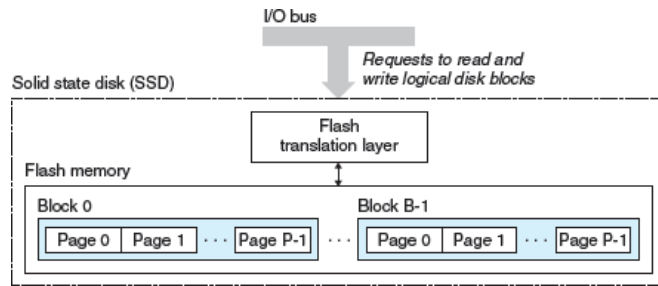


Figure 6.13 Solid state disk (SSD).

## 6.1.3 Solid State Disks

A solid state disk (SSD) is a storage technology, based on flash memory ([Section 6.1.1](#)), that in some situations is an attractive alternative to the conventional rotating disk. [Figure 6.13](#) shows the basic idea. An SSD package plugs into a standard disk slot on the I/O bus (typically USB or SATA) and behaves like any other disk, processing requests from the CPU to read and write logical disk blocks. An SSD package consists of one or more flash memory chips, which replace the mechanical drive in a conventional rotating disk, and a *flash translation layer*, which is a hardware/firmware device that plays the same role as a disk controller, translating requests for logical blocks into accesses of the underlying physical device.

[Figure 6.14](#) shows the performance characteristics of a typical SSD. Notice that reading from SSDs is faster than writing. The difference between random reading and writing performance is caused by a fundamental property of the underlying flash memory. As shown in [Figure 6.13](#), a flash memory consists of a sequence of  $B$  blocks, where each block consists of  $P$  pages. Typically, pages are 512 bytes to 4 KB in size, and a block consists of 32–128 pages, with total block sizes ranging from 16

### Figure 6.14 Performance characteristics of a commercial solid state disk.

Source: Intel SSD 730 product specification [53]. IOPS is I/O operations per second. Throughput numbers are based on reads and writes of 4 KB blocks. (Intel SSD 730 product specification. Intel Corporation. 52.)

KB to 512 KB. Data are read and written in units of pages. A page can be written only after the entire block to which it belongs has been *erased* (typically, this means that all bits in the block are set to 1). However, once a block is erased, each page in the block can be written once with no further erasing. A block wears out after roughly 100,000 repeated writes. Once a block wears out, it can no longer be used.

Random writes are slower for two reasons. First, erasing a block takes a relatively long time, on the order of 1 ms, which is more than an order of magnitude longer than it takes to access a page. Second, if a write operation attempts to modify a page  $p$  that contains existing data (i.e., not all ones), then any pages in the same block with useful data must be copied to a new (erased) block before the write to page  $p$  can occur. Manufacturers have developed sophisticated logic in the flash translation layer that attempts to amortize the high cost of erasing blocks and to minimize the number of internal copies on writes, but it is unlikely that random writing will ever perform as well as reading.

SSDs have a number of advantages over rotating disks. They are built of semiconductor memory, with no moving parts, and thus have much faster random access times than rotating disks, use less power, and are more rugged. However, there are some disadvantages. First, because flash blocks wear out after repeated writes, SSDs have the potential to wear out as well. *Wear-leveling* logic in the flash translation layer attempts to maximize the lifetime of each block by spreading erasures evenly across all blocks. In practice, the wear-leveling logic is so good that it takes many years for SSDs to wear out (see [Practice Problem 6.5](#)). Second, SSDs are about 30 times more expensive per byte than rotating disks, and thus the typical storage capacities are significantly less than rotating disks. However, SSD prices are decreasing rapidly as they become more popular, and the gap between the two is decreasing.

SSDs have completely replaced rotating disks in portable music devices, are popular as disk replacements in laptops, and have even begun to appear in desktops and servers. While rotating disks are here to stay, it is clear that SSDs are an important alternative.

### *Practice Problem 6.5 (solution page [662](#))*

As we have seen, a potential drawback of SSDs is that the underlying flash memory can wear out. For example, for the SSD in [Figure 6.14](#), Intel guarantees about 128 petabytes ( $128 \times 10^{15}$  bytes) of writes before the drive wears out. Given this assumption, estimate the lifetime (in years) of this SSD for the following workloads:

- A. **Worst case for sequential writes:** The SSD is written to continuously at a rate of 470 MB/s (the average sequential write throughput of the device).
- B. **Worst case for random writes:** The SSD is written to continuously at a rate of 303 MB/s (the average random write throughput of the device).
- C. **Average case:** The SSD is written to at a rate of 20 GB/day (the average daily write rate assumed by some computer manufacturers in their mobile computer workload simulations).



## 6.1.4 Storage Technology Trends

There are several important concepts to take away from our discussion of storage technologies.

*Different storage technologies have different price and performance trade-offs.* SRAM is somewhat faster than DRAM, and DRAM is much faster than disk. On the other hand, fast storage is always more expensive than slower storage. SRAM costs more per byte than DRAM. DRAM costs much more than disk. SSDs split the difference between DRAM and rotating disk.

*The price and performance properties of different storage technologies are changing at dramatically different rates.* [Figure 6.15](#) summarizes the price and performance properties of storage technologies since 1985, shortly after the first PCs were introduced. The numbers were culled from back issues of trade magazines and the Web. Although they were collected in an informal survey, the numbers reveal some interesting trends.

Since 1985, both the cost and performance of SRAM technology have improved at roughly the same rate. Access times and cost per megabyte have decreased by a factor of about 100 ([Figure 6.15\(a\)](#)). However, the trends for DRAM and disk are much more dramatic and divergent. While the cost per megabyte of DRAM has decreased by a factor of 44,000 (more than four orders of magnitude!), DRAM access times have decreased by only a factor of 10 ([Figure 6.15\(b\)](#)). Disk technology has followed the same trend as DRAM and in even more dramatic fashion. While the cost of a megabyte of disk storage has plummeted by a factor of more than 3,000,000 (more than six orders of magnitude!) since 1980, access times have improved much more slowly, by only a factor of 25 ([Figure 6.15\(c\)](#)). These startling long-term trends highlight a basic truth of memory and disk technology: it is much easier to increase density (and thereby reduce cost) than to decrease access time.

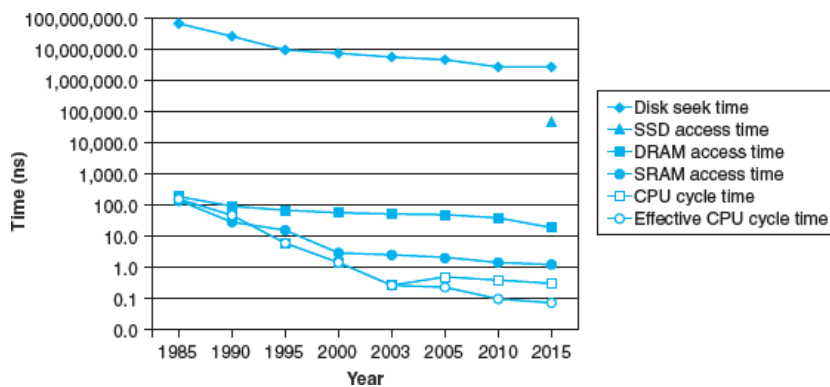
*DRAM and disk performance are lagging behind CPU performance.* As we see in [Figure 6.15\(d\)](#), CPU cycle times improved by a factor of 500 between 1985 and 2010. If we look at the *effective cycle time*—which we define to be the cycle time of an individual CPU (processor) divided by the number of its processor cores—then the improvement between 1985 and 2010 is even greater, a factor of 2,000.

**Figure 6.15 Storage and processing technology trends.**

The Core i7 circa 2010 uses the Nehalem processor core. The Core i7 circa 2015 uses the Haswell core.

The split in the CPU performance curve around 2003 reflects the introduction of multi-core processors (see aside on page 605). After this split, cycle times of individual cores actually increased a bit before starting to decrease again, albeit at a slower rate than before.

Note that while SRAM performance lags, it is roughly keeping up. However, the gap between DRAM and disk performance and CPU performance is actually widening. Until the advent of multi-core processors around 2003, this performance gap was a function of latency, with DRAM and disk access times decreasing more slowly than the cycle time of an individual processor. However, with the introduction of multiple cores, this performance gap is increasingly a function of




**Figure 6.16 The gap between disk, DRAM, and CPU speeds.**

throughput, with multiple processor cores issuing requests to the DRAM and disk in parallel.

The various trends are shown quite clearly in [Figure 6.16](#), which plots the access and cycle times from [Figure 6.15](#) on a semi-log scale.

As we will see in [Section 6.4](#), modern computers make heavy use of SRAM-based caches to try to bridge the processor-memory gap. This approach works because of a fundamental property of application programs known as *locality*, which we discuss next.

## *Practice Problem 6.6 (solution page **662**)*

Using the data from the years 2005 to 2015 in **Figure 6.15(c)** , estimate the year when you will be able to buy a petabyte ( $10^{15}$  bytes) of rotating disk storage for \$500. Assume actual dollars (no inflation).

[OceanofPDF.com](http://OceanofPDF.com)

## 6.2 Locality

Well-written computer programs tend to exhibit good *locality*. That is, they tend to reference data items that are near other recently referenced data items or that were recently referenced themselves. This tendency, known as the *principle of locality*, is an enduring concept that has enormous impact on the design and performance of hardware and software systems.

Locality is typically described as having two distinct forms: *temporal locality* and *spatial locality*. In a program with good temporal locality, a memory location that is referenced once is likely to be referenced again multiple times in the near future. In a program with good spatial locality, if a memory location is referenced


## Aside When cycle time stood still:

### The advent of multi-core processors

The history of computers is marked by some singular events that caused profound changes in the industry and the world. Interestingly, these inflection points tend to occur about once per decade: the development of Fortran in the 1950s, the introduction of the IBM 360 in the early 1960s, the dawn of the Internet (then called ARPANET) in the early 1970s, the introduction of the IBM PC in the early 1980s, and the creation of the World Wide Web in the early 1990s.

The most recent such event occurred early in the 21st century, when computer manufacturers ran headlong into the so-called power wall, discovering that they could no longer increase CPU clock frequencies as quickly because the chips would then consume too much power. The solution was to improve performance by replacing a single large processor with multiple smaller processor *cores*, each a complete processor capable of executing programs independently and in parallel with the other cores. This *multi-core* approach works in part because the power consumed by a processor is proportional to  $P = fCV^2$ , where  $f$  is the clock frequency,  $C$  is the capacitance, and  $V$  is the voltage. The capacitance  $C$  is roughly proportional to the area, so the power drawn by multiple cores can be held constant as long as the total area of the cores is constant. As long as feature sizes continue to shrink at the exponential Moore's Law rate, the number of

cores in each processor, and thus its effective performance, will continue to increase.

From this point forward, computers will get faster not because the clock frequency increases but because the number of cores in each processor increases, and because architectural innovations increase the efficiency of programs running on those cores. We can see this trend clearly in [Figure 6.16](#) . CPU cycle time reached its lowest point in 2003 and then actually started to rise before leveling off and starting to decline again at a slower rate than before. However, because of the advent of multi-core processors (dual-core in 2004 and quad-core in 2007), the effective cycle time continues to decrease at close to its previous rate.

once, then the program is likely to reference a nearby memory location in the near future.

Programmers should understand the principle of locality because, in general, *programs with good locality run faster than programs with poor locality*. All levels of modern computer systems, from the hardware, to the operating system, to application programs, are designed to exploit locality. At the hardware level, the principle of locality allows computer designers to speed up main memory accesses by introducing small fast memories known as *cache memories* that hold blocks of the most recently referenced instructions and data items. At the operating system level, the principle of locality allows the system to use the main memory as a cache of the most recently referenced chunks of the virtual address space. Similarly, the operating system uses main memory to cache

the most recently used disk blocks in the disk file system. The principle of locality also plays a crucial role in the design of application programs. For example, Web browsers exploit temporal locality by caching recently referenced documents on a local disk. High-volume Web servers hold recently requested documents in front-end disk caches that satisfy requests for these documents without requiring any intervention from the server.

```
1 int sumvec(int v[N])
2 {
3     int i, sum = 0;
4
5     for (i = 0; i < N; i++)
6         sum += v[i];
7     return sum;
8 }
```


(a)


(b)

**Figure 6.17 (a) A function with good locality, (b) Reference pattern for vector  $v$  ( $N = 8$ ).**

Notice how the vector elements are accessed in the same order that they are stored in memory.

## 6.2.1 Locality of References to Program Data


Consider the simple function in [Figure 6.17\(a\)](#)  that sums the elements of a vector. Does this function have good locality? To answer this question, we look at the reference pattern for each variable. In this example, the `sum` variable is referenced once in each loop iteration, and thus there is good temporal locality with respect to `sum`. On the other hand, since `sum` is a scalar, there is no spatial locality with respect to `sum`.


As we see in [Figure 6.17\(b\)](#) , the elements of vector `v` are read sequentially, one after the other, in the order they are stored in memory (we assume for convenience that the array starts at address 0). Thus, with respect to variable `v`, the function has good spatial locality but poor temporal locality since each vector element is accessed exactly once. Since the function has either good spatial or temporal locality with respect to each variable in the loop body, we can conclude that the `sumvec` function enjoys good locality.

A function such as `sumvec` that visits each element of a vector sequentially is said to have a *stride-1 reference pattern* (with respect to the element size). We will sometimes refer to stride-1 reference patterns as *sequential reference patterns*. Visiting every  $k$ th element of a contiguous vector is called a *stride- $k$  reference pattern*. Stride-1



reference patterns are a common and important source of spatial locality in programs. In general, as the stride increases, the spatial locality decreases.

Stride is also an important issue for programs that reference multidimensional arrays. For example, consider the `sumarrayrows` function in [Figure 6.18\(a\)](#)  that sums the elements of a two-dimensional array.

The doubly nested loop reads the elements of the array in *row-major order*. That is, the inner loop reads the elements of the first row, then the second row, and so on. The `sumarrayrows` function enjoys good spatial locality because it references the array in the same row-major order that the array is stored ([Figure 6.18\(b\)](#) ). The result is a nice stride-1 reference pattern with excellent spatial locality.

```
1 int sumarrayrows(int a[M][N])
2 {
3     int i, j, sum = 0;
4
5     for (i = 0; i < M; i++)
6         for (j = 0; j < N; j++)
7             sum += a[i][j];
8     return sum;
9 }
```

(a)

(b)

**Figure 6.18 (a) Another function with good locality, (b) Reference pattern for array  $a$  ( $M = 2, N = 3$ ).**

There is good spatial locality because the array is accessed in the same row-major order in which it is stored in memory.

```

1   int sumarraycols(int a[M][N])
2   {
3       int i, j, sum = 0 ;
4
5       for (j = 0; j < N; j++)
6           for (i = 0; i < M; i++)
7               sum += a[i] [j];
8       return sum;
9   }



```


(a)

(b)


**Figure 6.19 (a) A function with poor spatial locality, (b) Reference pattern for array  $a$  ( $M = 2, N = 3$ ).**

The function has poor spatial locality because it scans memory with a stride- $N$  reference pattern.

Seemingly trivial changes to a program can have a big impact on its locality. For example, the `sumarraycols` function in [Figure 6.19\(a\)](#)  computes the same result as the `sumarrayrows` function in [Figure 6.18\(a\)](#) . The only difference is that we have interchanged the  $i$  and  $j$  loops. What impact does interchanging the loops have on its locality?

The `sumarraycols` function suffers from poor spatial locality because it scans the array column-wise instead of row-wise. Since C arrays are laid out in memory row-wise, the result is a stride- $N$  reference pattern, as shown in [Figure 6.19\(b\)](#) .

## 6.2.2 Locality of Instruction Fetches

Since program instructions are stored in memory and must be fetched (read) by the CPU, we can also evaluate the locality of a program with respect to its instruction fetches. For example, in [Figure 6.17](#)  the instructions in the body of the `for` loop are executed in sequential memory order, and thus the loop enjoys good spatial locality. Since the loop body is executed multiple times, it also enjoys good temporal locality.

An important property of code that distinguishes it from program data is that it is rarely modified at run time. While a program is executing, the CPU reads its instructions from memory. The CPU rarely overwrites or modifies these instructions.

## 6.2.3 Summary of Locality

In this section, we have introduced the fundamental idea of locality and have identified some simple rules for qualitatively evaluating the locality in a program:

- Programs that repeatedly reference the same variables enjoy good temporal locality.
- For programs with stride- $k$  reference patterns, the smaller the stride, the better the spatial locality. Programs with stride-1 reference patterns have good spatial locality. Programs that hop around memory with large strides have poor spatial locality.
- Loops have good temporal and spatial locality with respect to instruction fetches. The smaller the loop body and the greater the number of loop iterations, the better the locality.

Later in this chapter, after we have learned about cache memories and how they work, we will show you how to quantify the idea of locality in terms of cache hits and misses. It will also become clear to you why programs with good locality typically run faster than programs with poor locality. Nonetheless, knowing how to glance at a source code and getting a high-level feel for the locality in the program is a useful and important skill for a programmer to master.

## Practice Problem 6.7 (solution page 662)

Permute the loops in the following function so that it scans the three-dimensional array *a* with a stride-1 reference pattern.

```
1 int sumarray3d(int a[N][N][N])
2 {
3     int i, j, k, sum = 0 ;
4
5     for (i = 0; i < N; i++) {
6         for (j = 0; j < N; j++) {
7             for (k = 0; k < N; k++) {
8                 sum += a[k] [i]
9                 [j];
10            }
11        }
12    }
13    return sum;
}
```

(a) An array of `structs`

```
|  
1     #define N 1000  
2  
3     typedef struct {  
4         int vel [3];  
5         int acc [3];  
6     } point;  
7  
8     point p [N];
```

(b) The `clear1` function

```
|  
1 void clear1(point *p, int n)  
2 {  
3     int i, j;  
4  
5     for (i = 0; i < n; i++) {  
6         for (j = 0; j < 3; j++)  
7             p[i].vel[j] = 0;  
8         for (j = 0; j < 3; j++)  
9             p[i].acc[j] = 0;  
10    }  
11 }
```

(c) The `clear2` function



```
|  
1 void clear2(point *p, int n)  
2 {  
3     int i, j;  
4  
5     for (i = 0; i < n; i++) {  
6         for (j = 0; j < 3; j++) {  
7             p[i] .vel[j] = 0;  
8             p[i] .acc[j] = 0;  
9         }  
10    }  
11 }
```

(d) The `clear3` function

```

1 void clear3(point *p, int n)
2 {
3     int i, j;
4
5     for (j = 0; j < 3; j++) {
6         for (i = 0; i < n; i++)
7             p[i].vel[j] = 0;
8         for (i = 0; i < n; i++)
9             p[i].acc[j] = 0;
10    }
11 }

```

Figure 6.20 Code examples for [Practice Problem 6.8](#).

## *Practice Problem 6.8 (solution page [663](#))*

The three functions in [Figure 6.20](#) perform the same operation with varying degrees of spatial locality. Rank-order the functions with respect to the spatial locality enjoyed by each. Explain how you arrived at your ranking.

## 6.3 The Memory Hierarchy

Section 6.1 and 6.2 described some fundamental and enduring properties of storage technology and computer software:

**Storage technology.** Different storage technologies have widely different access times. Faster technologies cost more per byte than slower ones and have less capacity. The gap between CPU and main memory speed is widening.

**Computer software.** Well-written programs tend to exhibit good locality.

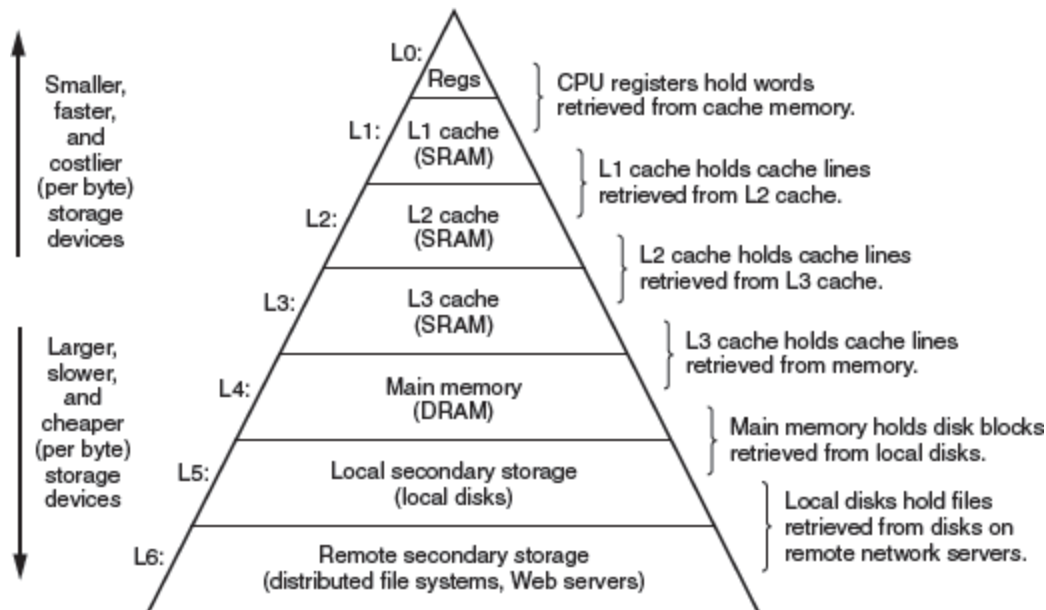



Figure 6.21 The memory hierarchy.

In one of the happier coincidences of computing, these fundamental properties of hardware and software complement each other beautifully. Their complementary nature suggests an approach for organizing memory systems, known as the *memory hierarchy*, that is used in all modern computer systems. [Figure 6.21](#)  shows a typical memory hierarchy.

In general, the storage devices get slower, cheaper, and larger as we move from higher to lower *levels*. At the highest level (L0) are a small number of fast CPU registers that the CPU can access in a single clock cycle. Next are one or more small to moderate-size SRAM-based cache memories that can be accessed in a few CPU clock cycles. These are followed by a large DRAM-based main memory that can be accessed in tens to hundreds of clock cycles. Next are slow but enormous local disks. Finally, some systems even include an additional level of disks on remote servers that can be accessed over a network. For example, distributed file systems such as the Andrew File System (AFS) or the Network File System (NFS) allow a program to access files that are stored on remote network-connected servers. Similarly, the World Wide Web allows programs to access remote files stored on Web servers anywhere in the world.

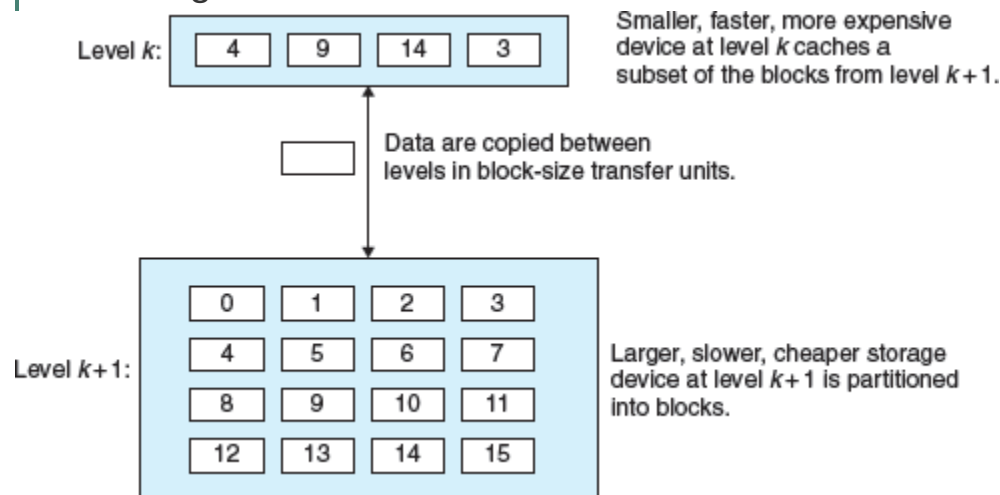
## 6.3.1 Caching in the Memory Hierarchy

In general, a *cache* (pronounced "cash") is a small, fast storage device that acts as a staging area for the data objects stored in a larger, slower device. The process of using a cache is known as *caching* (pronounced "cashing").

The central idea of a memory hierarchy is that for each  $k$ , the faster and smaller storage device at level  $k$  serves as a cache for the larger and slower storage device



## Aside Other memory hierarchies


We have shown you one example of a memory hierarchy, but other combinations are possible, and indeed common. For example, many sites, including Google datacenters, back up local disks onto archival magnetic tapes. At some of these sites, human operators manually mount the tapes onto tape drives as needed. At other sites, tape robots handle this task automatically. In either case, the collection of tapes represents a level in the memory hierarchy, below the local disk level, and the same general principles apply. Tapes are cheaper per byte than disks, which allows sites to archive multiple snapshots of their local disks. The trade-off is that tapes take longer to access than disks. As another example, solid state disks are playing an increasingly important role in the memory hierarchy, bridging the gulf between DRAM and rotating disk.




**Figure 6.22** The basic principle of caching in a memory hierarchy.

at level  $k + 1$ . In other words, each level in the hierarchy caches data objects from the next lower level. For example, the local disk serves as a cache for files (such as Web pages) retrieved from remote disks over the network, the main memory serves as a cache for data on the local disks, and so on, until we get to the smallest cache of all, the set of CPU registers.

**Figure 6.22**  shows the general concept of caching in a memory hierarchy. The storage at level  $k + 1$  is partitioned into contiguous chunks of data objects called *blocks*. Each block has a unique address or name that distinguishes it from other blocks. Blocks can be either fixed size (the usual case) or variable size (e.g., the remote HTML files stored on Web servers). For example, the level  $k + 1$  storage in **Figure 6.22**  is partitioned into 16 fixed-size blocks, numbered 0 to 15.

Similarly, the storage at level  $k$  is partitioned into a smaller set of blocks that are the same size as the blocks at level  $k + 1$ . At any point in time, the cache at level  $k$  contains copies of a subset of the blocks from level  $k + 1$ . For example, in **Figure 6.22** , the cache at level  $k$  has room for four blocks and currently contains copies of blocks 4, 9, 14, and 3.

Data are always copied back and forth between level  $k$  and level  $k + 1$  in block-size *transfer units*. It is important to realize that while the block size is fixed between any particular pair of adjacent levels in the hierarchy, other pairs of levels can have different block sizes. For example, in **Figure 6.21** , transfers between L1 and L0 typically

use word-size blocks. Transfers between L2 and L1 (and L3 and L2, and L4 and L3) typically use blocks of tens of bytes. And transfers between L5 and L4 use blocks with hundreds or thousands of bytes. In general, devices lower in the hierarchy (further from the CPU) have longer access times, and thus tend to use larger block sizes in order to amortize these longer access times.

## *Cache Hits*


When a program needs a particular data object  $d$  from level  $k + 1$ , it first looks for  $d$  in one of the blocks currently stored at level  $k$ . If  $d$  happens to be cached at level  $k$ , then we have what is called a *cache hit*. The program reads  $d$  directly from level  $k$ , which by the nature of the memory hierarchy is faster than reading  $d$  from level  $k + 1$ . For example, a program with good temporal locality might read a data object from block 14, resulting in a cache hit from level  $k$ .



## Cache Misses

If, on the other hand, the data object  $d$  is not cached at level  $k$ , then we have what is called a *cache miss*. When there is a miss, the cache at level  $k$  fetches the block containing  $d$  from the cache at level  $k + 1$ , possibly overwriting an existing block if the level  $k$  cache is already full.



This process of overwriting an existing block is known as *replacing* or *evicting* the block. The block that is evicted is sometimes referred to as a *victim block*. The decision about which block to replace is governed by the cache's *replacement policy*. For example, a cache with a *random replacement policy* would choose a random victim block. A cache with a *least recently used (LRU)* replacement policy would choose the block that was last accessed the furthest in the past.


After the cache at level  $k$  has fetched the block from level  $k + 1$ , the program can read  $d$  from level  $k$  as before. For example, in [Figure 6.22](#) , reading a data object from block 12 in the level  $k$  cache would result in a cache miss because block 12 is not currently stored in the level  $k$  cache. Once it has been copied from level  $k + 1$  to level  $k$ , block 12 will remain there in expectation of later accesses.

## *Kinds of Cache Misses*

It is sometimes helpful to distinguish between different kinds of cache misses. If the cache at level  $k$  is empty, then any access of any data object will miss. An empty cache is sometimes referred to as a *cold cache*, and misses of this kind are called *compulsory misses* or *cold misses*. Cold misses are important because they are often transient events that might not occur in steady state, after the cache has been *warmed up* by repeated memory accesses.

Whenever there is a miss, the cache at level  $k$  must implement some *placement policy* that determines where to place the block it has retrieved from level  $k + 1$ . The most flexible placement policy is to allow any block from level  $k + 1$  to be stored in any block at level  $k$ . For caches high in the memory hierarchy (close to the CPU) that are implemented in hardware and where speed is at a premium, this policy is usually too expensive to implement because randomly placed blocks are expensive to locate.

Thus, hardware caches typically implement a simpler placement policy that restricts a particular block at level  $k + 1$  to a small subset (sometimes a singleton) of the blocks at level  $k$ . For example, in [Figure 6.22](#) , we might decide that a block  $i$  at level  $k + 1$  must be placed in block  $(i \bmod 4)$  at level  $k$ . For example, blocks 0, 4, 8, and 12 at level  $k + 1$  would map to block 0 at level  $k$ ; blocks 1, 5, 9, and 13 would map to block 1; and so on. Notice that our example cache in [Figure 6.22](#)  uses this policy.

Restrictive placement policies of this kind lead to a type of miss known as a *conflict miss*, in which the cache is large enough to hold the referenced data objects, but because they map to the same cache block, the cache keeps missing. For example, in [Figure 6.22](#) , if the program requests block 0, then block 8, then block 0, then block 8, and so on, each of the references to these two blocks would miss in the cache at level  $k$ , even though this cache can hold a total of four blocks.

Programs often run as a sequence of phases (e.g., loops) where each phase accesses some reasonably constant set of cache blocks. For example, a nested loop might access the elements of the same array over and over again. This set of blocks is called the *working set* of the phase. When the size of the working set exceeds the size of the cache, the cache will experience what are known as *capacity misses*. In other words, the cache is just too small to handle this particular working set.

# Cache Management

As we have noted, the essence of the memory hierarchy is that the storage device at each level is a cache for the next lower level. At each level, some form of logic must *manage* the cache. By this we mean that something has to partition the cache storage into blocks, transfer blocks between different levels, decide when there are hits and misses, and then deal with them. The logic that manages the cache can be hardware, software, or a combination of the two.

For example, the compiler manages the register file, the highest level of the cache hierarchy. It decides when to issue loads when there are misses, and determines which register to store the data in. The caches at levels L1, L2, and L3 are managed entirely by hardware logic built into the caches. In a system with virtual memory, the DRAM main memory serves as a cache for data blocks stored on disk, and is managed by a combination of operating system software and address translation hardware on the CPU. For a machine with a distributed file system such as AFS, the local disk serves as a cache that is managed by the AFS client process running on the local machine. In most cases, caches operate automatically and do not require any specific or explicit actions from the program.

**Figure 6.23 The ubiquity of caching in modern computer systems.**



Acronyms: TLB: translation lookaside buffer; MMU: memory management unit; OS: operating system; NFS: network file system.

## 6.3.2 Summary of Memory Hierarchy Concepts

To summarize, memory hierarchies based on caching work because slower storage is cheaper than faster storage and because programs tend to exhibit locality:

**Exploiting temporal locality.** Because of temporal locality, the same data objects are likely to be reused multiple times. Once a data object has been copied into the cache on the first miss, we can expect a number of subsequent hits on that object. Since the cache is faster than the storage at the next lower level, these subsequent hits can be served much faster than the original miss.

**Exploiting spatial locality.** Blocks usually contain multiple data objects. Because of spatial locality, we can expect that the cost of copying a block after a miss will be amortized by subsequent references to other objects within that block.

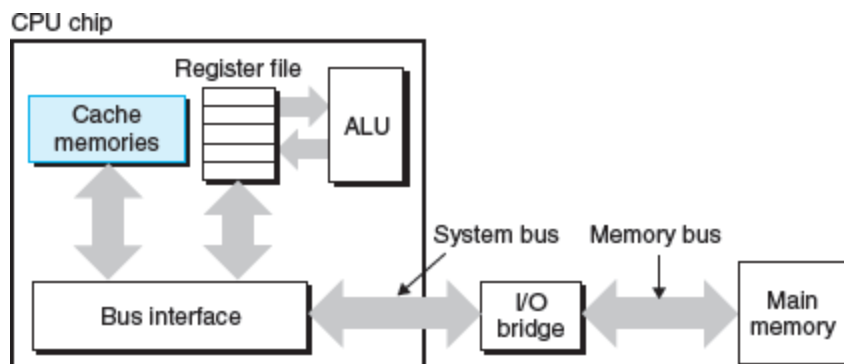
Caches are used everywhere in modern systems. As you can see from [Figure 6.23](#) , caches are used in CPU chips, operating systems, distributed file systems, and on the World Wide Web. They are built from and managed by various combinations of hardware and software. Note that there are a number of terms and acronyms in [Figure 6.23](#)  that we haven't covered yet. We include them here to demonstrate how common caches are.

[OceanofPDF.com](http://OceanofPDF.com)

## 6.4 Cache Memories

The memory hierarchies of early computer systems consisted of only three levels: CPU registers, main memory, and disk storage.

However, because of the increasing gap between CPU and main memory, system designers were compelled to insert



**Figure 6.24** Typical bus structure for cache memories.

a small SRAM *cache memory*, called an *L1 cache* (level 1 cache) between the CPU register file and main memory, as shown in [Figure 6.24](#). The L1 cache can be accessed nearly as fast as the registers, typically in about 4 clock cycles.

As the performance gap between the CPU and main memory continued to increase, system designers responded by inserting an additional larger cache, called an *L2 cache*, between the L1 cache and main memory, that can be accessed in about 10 clock cycles. Many modern systems include an even larger cache, called an *L3*



*cache*, which sits between the L2 cache and main memory in the memory hierarchy and can be accessed in about 50 cycles. While there is considerable variety in the arrangements, the general principles are the same. For our discussion in the next section, we will assume a simple memory hierarchy with a single L1 cache between the CPU and main memory.

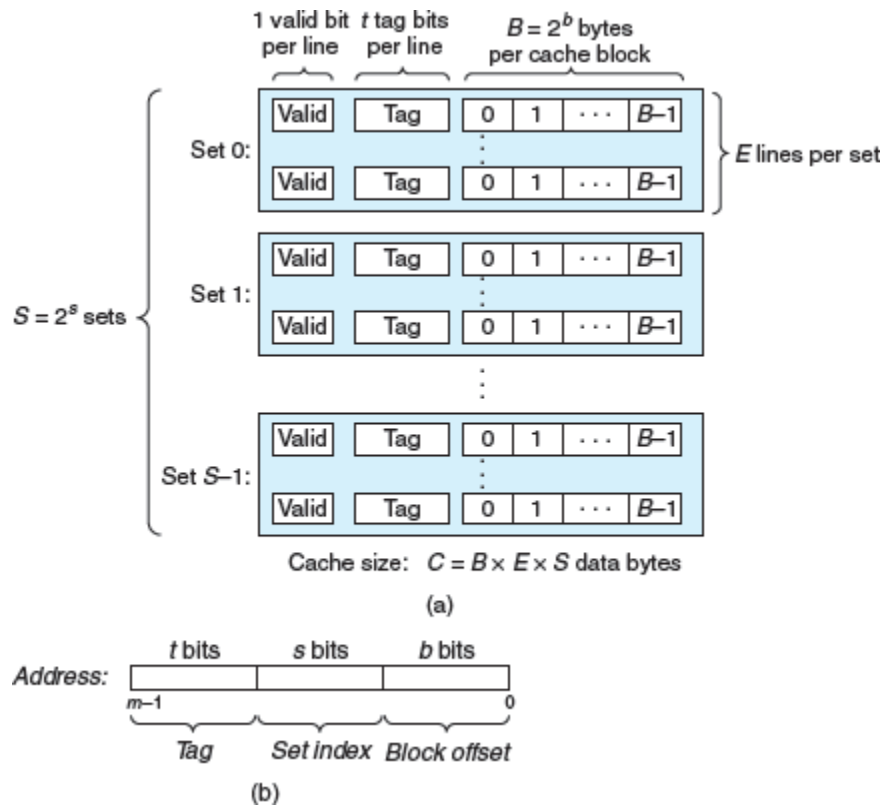
## 6.4.1 Generic Cache Memory Organization

Consider a computer system where each memory address has  $m$  bits that form  $M = 2^m$  unique addresses. As illustrated in [Figure 6.25\(a\)](#), a cache for such a machine is organized as an array of  $S = 2^s$  cache sets. Each set consists of  $E$  cache lines. Each line consists of a data block of  $B = 2^b$  bytes, a *valid bit* that indicates whether or not the line contains meaningful information, and  $t = m - (b + s)$  tag bits (a subset of the bits from the current block's memory address) that uniquely identify the block stored in the cache line.

In general, a cache's organization can be characterized by the tuple  $(S, E, B, m)$ . The size (or capacity) of a cache,  $C$ , is stated in terms of the aggregate size of all the blocks. The tag bits and valid bit are not included. Thus,  $C = S \times E \times B$ .

When the CPU is instructed by a load instruction to read a word from address  $A$  of main memory, it sends address  $A$  to the cache. If the cache is holding a copy of the word at address  $A$ , it sends the word immediately back to the CPU. So how does the cache know whether it contains a copy of the word at address  $A$ ? The cache is organized so that it can find the requested word by simply inspecting the bits of the address, similar to a hash table with an extremely simple hash function. Here is how it works:

The parameters  $S$  and  $B$  induce a partitioning of the  $m$  address bits into the three fields shown in **Figure 6.25(b)**. The  $s$  set index bits in  $A$  form an index into




**Figure 6.25 General organization of cache ( $S$ ,  $E$ ,  $B$ ,  $m$ ).**

(a) A cache is an array of sets. Each set contains one or more lines. Each line contains a valid bit, some tag bits, and a block of data, (b) The cache organization induces a partition of the  $m$  address bits into  $t$  tag bits,  $s$  set index bits, and  $b$  block offset bits.

the array of  $S$  sets. The first set is set 0, the second set is set 1, and so on. When interpreted as an unsigned integer, the set index bits tell us which set the word must be stored in. Once we know which set the word must be contained in, the  $t$  tag bits in  $A$  tell us which line

(if any) in the set contains the word. A line in the set contains the word if and only if the valid bit is set and the tag bits in the line match the tag bits in the address  $A$ . Once we have located the line identified by the tag in the set identified by the set index, then the  $b$  *block offset bits* give us the offset of the word in the  $B$ -byte data block.

As you may have noticed, descriptions of caches use a lot of symbols. **Figure 6.26**  summarizes these symbols for your reference.

## *Practice Problem 6.9 (solution page **663**)*

The following table gives the parameters for a number of different caches. For each cache, determine the number of cache sets ( $S$ ), tag bits ( $t$ ), set index bits ( $s$ ), and block offset bits ( $b$ ).

Figure 6.26 Summary of cache parameters.

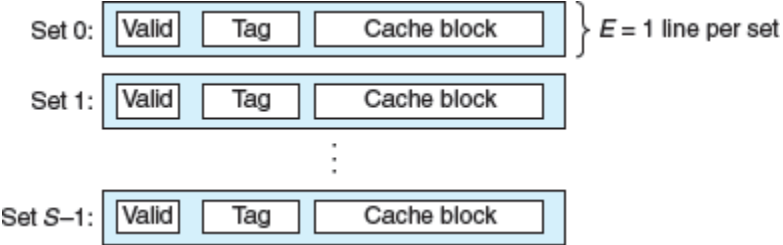



Figure 6.27 Direct-mapped cache ( $E = 1$ ).

There is exactly one line per set.

## 6.4.2 Direct-Mapped Caches

Caches are grouped into different classes based on  $E$ , the number of cache lines per set. A cache with exactly one line per set ( $E = 1$ ) is known as a *direct-mapped* cache (see [Figure 6.27](#) ). Direct-mapped caches are the simplest both to implement and to understand, so we will use them to illustrate some general concepts about how caches work.

Suppose we have a system with a CPU, a register file, an L1 cache, and a main memory. When the CPU executes an instruction that reads a memory word  $w$ , it requests the word from the L1 cache. If the L1 cache has a cached copy of  $w$ , then we have an L1 cache hit, and the cache quickly extracts  $w$  and returns it to the CPU.

Otherwise, we have a cache miss, and the CPU must wait while the L1 cache requests a copy of the block containing  $w$  from the main memory. When the requested block finally arrives from memory, the L1 cache stores the block in one of its cache lines, extracts word  $w$  from the stored block, and returns it to the CPU. The process that a cache goes through of determining whether a request is a hit or a miss and then extracting the requested word consists of three steps: (1) *set selection*, (2) *line matching*, and (3) *word extraction*.

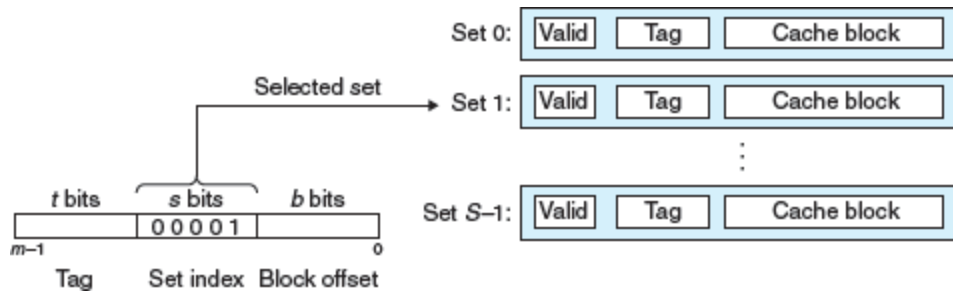


Figure 6.28 Set selection in a direct-mapped cache.

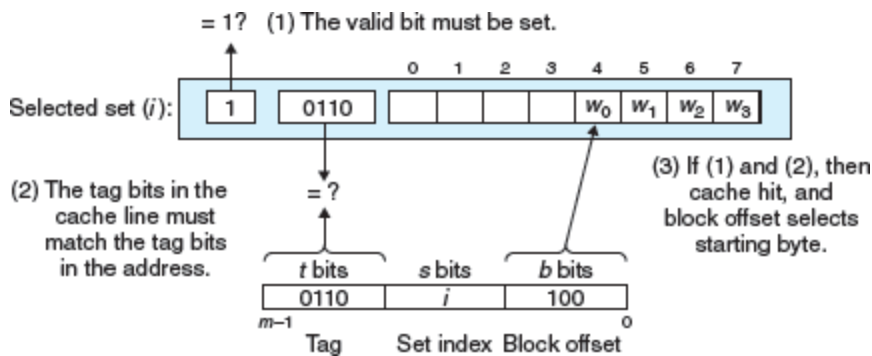


Figure 6.29 Line matching and word selection in a direct-mapped cache.


Within the cache block,  $w_0$  denotes the low-order byte of the word  $w$ ,  $w_1$  the next byte, and so on.

## Set Selection in Direct-Mapped Caches

In this step, the cache extracts the  $s$  set index bits from the middle of the address for  $w$ . These bits are interpreted as an unsigned integer that corresponds to a set number. In other words, if we think of the cache as a one-dimensional array of sets, then the set index bits form an index into this array. [Figure 6.28](#) shows how set selection works for a direct-mapped cache. In this example, the set index bits  $00001_2$  are interpreted as an integer index that selects set 1.


## *Line Matching in Direct-Mapped Caches*

Now that we have selected some set  $i$  in the previous step, the next step is to determine if a copy of the word  $w$  is stored in one of the cache lines contained in set  $i$ . In a direct-mapped cache, this is easy and fast because there is exactly one line per set. A copy of  $w$  is contained in the line if and only if the valid bit is set and the tag in the cache line matches the tag in the address of  $w$ .

**Figure 6.29**  shows how line matching works in a direct-mapped cache. In this example, there is exactly one cache line in the selected set. The valid bit for this line is set, so we know that the bits in the tag and block are meaningful. Since the tag bits in the cache line match the tag bits in the address, we know that a copy of the word we want is indeed stored in the line. In other words, we have a cache hit. On the other hand, if either the valid bit were not set or the tags did not match, then we would have had a cache miss.



## *Word Selection in Direct-Mapped Caches*

Once we have a hit, we know that  $w$  is somewhere in the block. This last step determines where the desired word starts in the block. As shown in [Figure 6.29](#) , the block offset bits provide us with the offset of the first byte in the desired word. Similar to our view of a cache as an array of lines, we can think of a block as an array of bytes, and the byte offset as an index into that array. In the example, the block offset bits of  $100_2$  indicate that the copy of  $w$  starts at byte 4 in the block. (We are assuming that words are 4 bytes long.)

## *Line Replacement on Misses in Direct-Mapped Caches*


If the cache misses, then it needs to retrieve the requested block from the next level in the memory hierarchy and store the new block in one of the cache lines of the set indicated by the set index bits. In general, if the set is full of valid cache lines, then one of the existing lines must be evicted. For a direct-mapped cache, where each set contains exactly one line, the replacement policy is trivial: the current line is replaced by the newly fetched line.

## *Putting It Together: A Direct-Mapped Cache in Action*

The mechanisms that a cache uses to select sets and identify lines are extremely simple. They have to be, because the hardware must perform them in a few nanoseconds. However, manipulating bits in this way can be confusing to us humans. A concrete example will help clarify the process. Suppose we have a direct-mapped cache described by

$$(S, E, B, m) = (4, 1, 2, 4)$$

In other words, the cache has four sets, one line per set, 2 bytes per block, and 4-bit addresses. We will also assume that each word is a single byte. Of course, these assumptions are totally unrealistic, but they will help us keep the example simple.

When you are first learning about caches, it can be very instructive to enumerate the entire address space and partition the bits, as we've done in [Figure 6.30](#)  for our 4-bit example. There are some interesting things to notice about this enumerated space:

- The concatenation of the tag and index bits uniquely identifies each block in memory. For example, block 0 consists of addresses 0 and 1, block 1 consists of addresses 2 and 3, block 2 consists of addresses 4 and 5, and so on.
- Since there are eight memory blocks but only four cache sets, multiple blocks map to the same cache set (i.e., they have the

same set index). For example, blocks 0 and 4 both map to set 0, blocks 1 and 5 both map to set 1, and so on.

- Blocks that map to the same cache set are uniquely identified by the tag. For example, block 0 has a tag bit of 0 while block 4 has a tag bit of 1, block 1 has a tag bit of 0 while block 5 has a tag bit of 1, and so on.

### Figure 6.30 4-bit address space for example direct-mapped cache.

Let us simulate the cache in action as the CPU performs a sequence of reads. Remember that for this example we are assuming that the CPU reads 1-byte words. While this kind of manual simulation is tedious and you may be tempted to skip it, in our experience students do not really understand how caches work until they work their way through a few of them.

Initially, the cache is empty (i.e., each valid bit is 0):

Each row in the table represents a cache line. The first column indicates the set that the line belongs to, but keep in mind that this is provided for convenience and is not really part of the cache. The next four columns represent the actual bits in each cache line. Now, let's see what happens when the CPU performs a sequence of reads:

1. **Read word at address 0.** Since the valid bit for set 0 is 0, this is a cache miss. The cache fetches block 0 from memory (or a lower-level cache) and stores the block in set 0. Then the cache returns  $m[0]$  (the contents of memory location 0) from  $block[0]$  of the newly fetched cache line.

2. **Read word at address 1.** This is a cache hit. The cache immediately returns  $m[1]$  from  $\text{block}[1]$  of the cache line. The state of the cache does not change.
3. **Read word at address 13.** Since the cache line in set 2 is not valid, this is a cache miss. The cache loads block 6 into set 2 and returns  $m[13]$  from  $\text{block}[1]$  of the new cache line.
4. **Read word at address 8.** This is a miss. The cache line in set 0 is indeed valid, but the tags do not match. The cache loads block 4 into set 0 (replacing the line that was there from the read of address 0) and returns  $m[8]$  from  $\text{block}[0]$  of the new cache line.
5. **Read word at address 0.** This is another miss, due to the unfortunate fact that we just replaced block 0 during the previous reference to address 8. This kind of miss, where we have plenty of room in the cache but keep alternating references to blocks that map to the same set, is an example of a conflict miss.

# Conflict Misses in Direct-Mapped Caches

Conflict misses are common in real programs and can cause baffling performance problems. Conflict misses in direct-mapped caches typically occur when programs access arrays whose sizes are a power of 2. For example, consider a function that computes the dot product of two vectors:

```
1 float dotprod(float x [8], float y [8])
2 {
3     float sum = 0.0;
4     int i;
5
6     for (i = 0; i < 8; i++)
7         sum += x [i] * y [i];
8     return sum;
9 }
```

This function has good spatial locality with respect to `x` and `y`, and so we might expect it to enjoy a good number of cache hits. Unfortunately, this is not always true.

Suppose that floats are 4 bytes, that `x` is loaded into the 32 bytes of contiguous memory starting at address 0, and that `y` starts immediately after `x` at address 32. For simplicity, suppose that a

block is 16 bytes (big enough to hold four floats) and that the cache consists of two sets, for a total cache size of 32 bytes. We will assume that the variable `sum` is actually stored in a CPU register and thus does not require a memory reference. Given these assumptions, each `x[i]` and `y[i]` will map to the identical cache set:

At run time, the first iteration of the loop references `x[0]`, a miss that causes the block containing `x[0]-x[3]` to be loaded into set 0. The next reference is to `y[0]`, another miss that causes the block containing `y[0]-y[3]` to be copied into set 0, overwriting the values of `x` that were copied in by the previous reference. During the next iteration, the reference to `x[1]` misses, which causes the `x[0]-x[3]` block to be loaded back into set 0, overwriting the `y[0]-y[3]` block. So now we have a conflict miss, and in fact each subsequent reference to `x` and `y` will result in a conflict miss as we thrash back and forth between blocks of `x` and `y`. The term *thrashing* describes any situation where a cache is repeatedly loading and evicting the same sets of cache blocks.



## Aside Why index with the middle bits?

You may be wondering why caches use the middle bits for the set index instead of the high-order bits. There is a good reason why the middle bits are better. [Figure 6.31](#) shows why. If the high-order bits are used as an index, then some contiguous memory blocks will map to the same cache set. For example, in the figure, the first four blocks map to the first cache set, the second four blocks map to the second set, and so on. If a program has good spatial locality and scans the elements of an array sequentially, then the cache can only hold a block-size chunk of the array at any point in time. This is an inefficient use of the cache. Contrast this with middle-bit indexing, where adjacent blocks always map to different cache sets. In this case, the cache can hold an entire  $C$ -size chunk of the array, where  $C$  is the cache size.

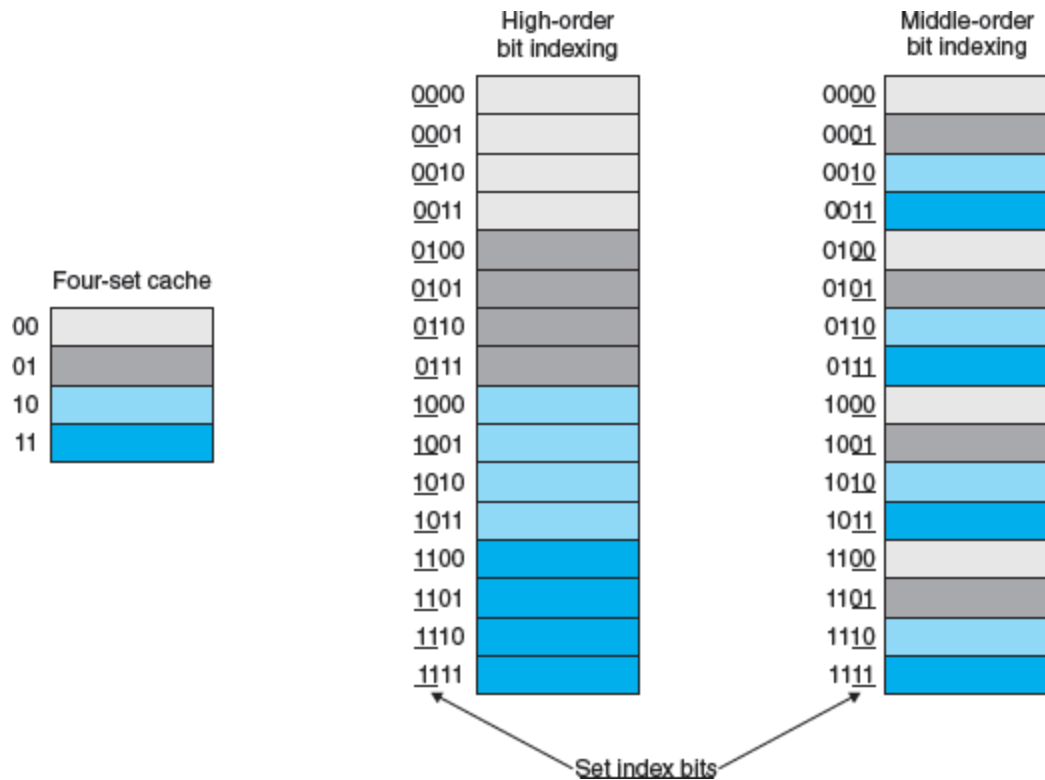


Figure 6.31 Why caches index with the middle bits.

The bottom line is that even though the program has good spatial locality and we have room in the cache to hold the blocks for both  $x[i]$  and  $y[i]$ , each reference results in a conflict miss because the blocks map to the same cache set. It is not unusual for this kind of thrashing to result in a slowdown by a factor of 2 or 3. Also, be aware that even though our example is extremely simple, the problem is real for larger and more realistic direct-mapped caches.

Luckily, thrashing is easy for programmers to fix once they recognize what is going on. One easy solution is to put  $B$  bytes of padding at the end of each array. For example, instead of defining  $x$  to be float  $x[8]$ , we define it to be float  $x[12]$ . Assuming  $y$  starts immediately

after `x` in memory, we have the following mapping of array elements to sets:

With the padding at the end of `x`, `x[i]` and `y[i]` now map to different sets, which eliminates the thrashing conflict misses.

## Practice Problem 6.10 (solution page [663](#))

In the previous `dotprod` example, what fraction of the total references to `x` and `y` will be hits once we have padded array `x`?

## Practice Problem 6.11 (solution page [663](#))

Imagine a hypothetical cache that uses the high-order  $s$  bits of an address as the set index. For such a cache, contiguous chunks of memory blocks are mapped to the same cache set.

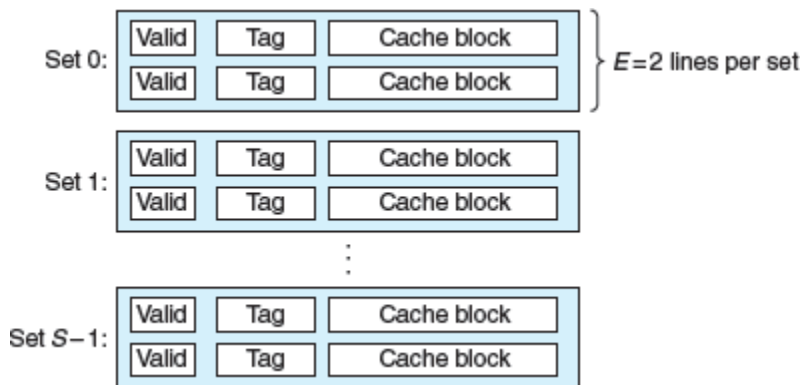
- A. How many blocks are in each of these contiguous array chunks?
- B. Consider the following code that runs on a system with a cache of the form  $(S, E, B, m) = (512, 1, 32, 32)$ :

```
|
int array[4096];
for (i = 0; i < 4096; i++)
    sum += array [i];
```

What is the maximum number of array blocks that are stored in the cache at any point in time?

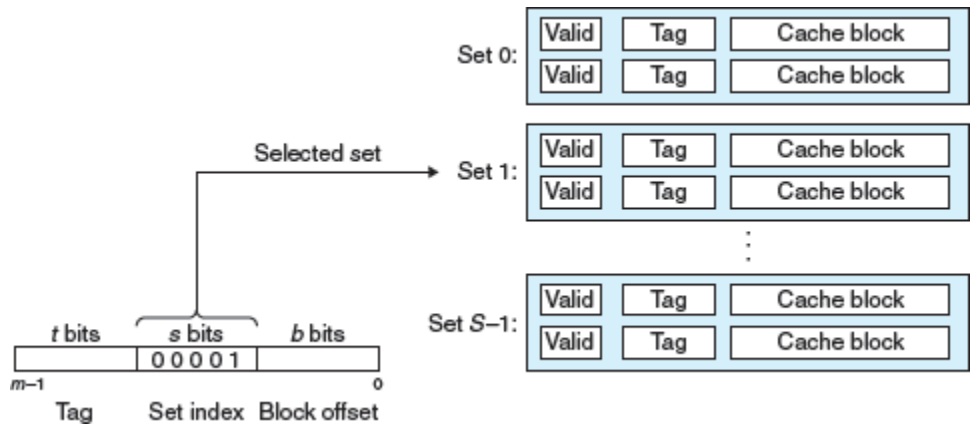
## 6.4.3 Set Associative Caches

The problem with conflict misses in direct-mapped caches stems from the constraint that each set has exactly one line (or in our terminology,  $E = 1$ ). A *set associative cache* relaxes this constraint so that each set holds more than one cache line. A cache with  $1 < E < C/B$  is often called an  $E$ -way set associative cache. We




**Figure 6.32 Set associative cache ( $1 < E < C/B$ ).**

In a set associative cache, each set contains more than one line. This particular example shows a two-way set associative cache.




**Figure 6.33** Set selection in a set associative cache.

will discuss the special case, where  $E = C/B$ , in the next section.

**Figure 6.32**  shows the organization of a two-way set associative cache.

## *Set Selection in Set Associative Caches*

Set selection is identical to a direct-mapped cache, with the set index bits identifying the set. **Figure 6.33**  summarizes this principle.

# Line Matching and Word Selection in Set Associative Caches

Line matching is more involved in a set associative cache than in a direct-mapped cache because it must check the tags and valid bits of multiple lines in order to determine if the requested word is in the set. A conventional memory is an array of values that takes an address as input and returns the value stored at that address. An *associative memory*, on the other hand, is an array of (key, value) pairs that takes as input the key and returns a value from one of the (key, value) pairs that matches the input key. Thus, we can think of each set in a set associative cache as a small associative memory where the keys are the concatenation of the tag and valid bits, and the values are the contents of a block.

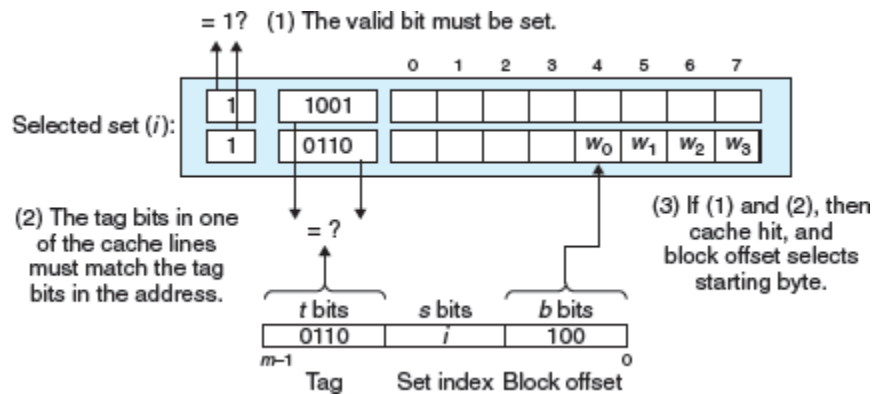


Figure 6.34 Line matching and word selection in a set associative cache.

Figure 6.34 shows the basic idea of line matching in an associative cache. An important idea here is that any line in the set

can contain any of the memory blocks that map to that set. So the cache must search each line in the set for a valid line whose tag matches the tag in the address. If the cache finds such a line, then we have a hit and the block offset selects a word from the block, as before.



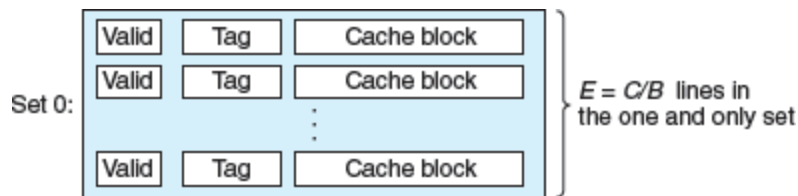
## *Line Replacement on Misses in Set Associative Caches*

If the word requested by the CPU is not stored in any of the lines in the set, then we have a cache miss, and the cache must fetch the block that contains the word from memory. However, once the cache has retrieved the block, which line should it replace? Of course, if there is an empty line, then it would be a good candidate. But if there are no empty lines in the set, then we must choose one of the nonempty lines and hope that the CPU does not reference the replaced line anytime soon.

It is very difficult for programmers to exploit knowledge of the cache replacement policy in their codes, so we will not go into much detail about it here. The simplest replacement policy is to choose the line to replace at random. Other more sophisticated policies draw on the principle of locality to try to minimize the probability that the replaced line will be referenced in the near future. For example, a *least frequently used (LFU)* policy will replace the line that has been referenced the fewest times over some past time window. A *least recently used (LRU)* policy will replace the line that was last accessed the furthest in the past. All of these policies require additional time and hardware. But as we move further down the memory hierarchy, away from the CPU, the cost of a miss becomes more expensive and it becomes more worthwhile to minimize misses with good replacement policies.

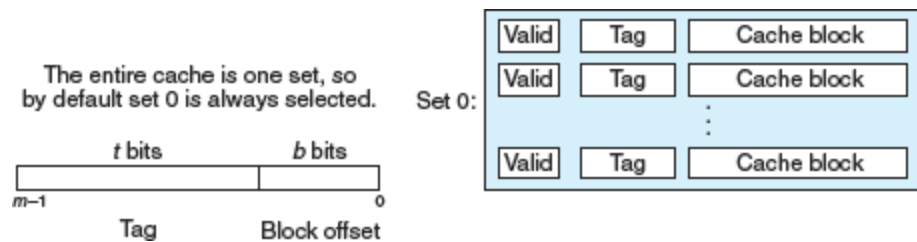
## 6.4.4 Fully Associative Caches

A *fully associative cache* consists of a single set (i.e.,  $E = C/B$ ) that contains all of the cache lines. [Figure 6.35](#) shows the basic organization.



**Figure 6.35 Fully associative cache ( $E = C/B$ ).**

In a fully associative cache, a single set contains all of the lines.



**Figure 6.36 Set selection in a fully associative cache.**

Notice that there are no set index bits.

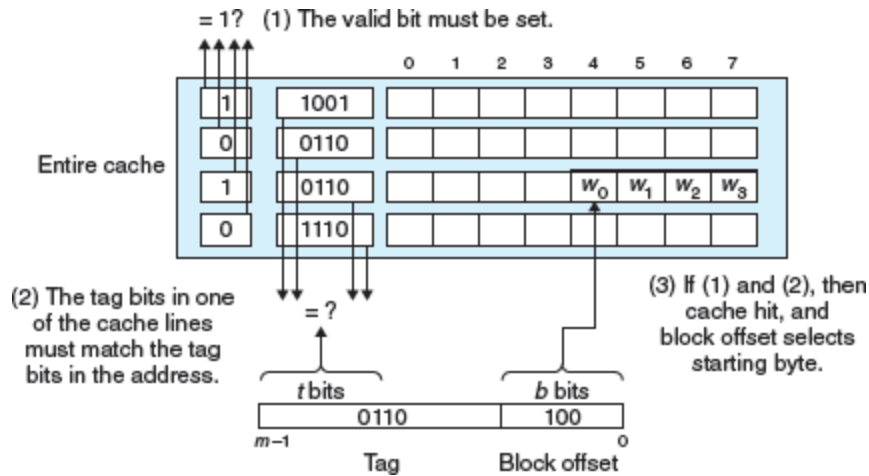


Figure 6.37 Line matching and word selection in a fully associative cache.

## Set Selection in Fully Associative Caches

Set selection in a fully associative cache is trivial because there is only one set, summarized in [Figure 6.36](#). Notice that there are no set index bits in the address, which is partitioned into only a tag and a block offset.

## *Line Matching and Word Selection in Fully Associative Caches*

Line matching and word selection in a fully associative cache work the same as with a set associative cache, as we show in [Figure 6.37](#). The difference is mainly a question of scale.

Because the cache circuitry must search for many matching tags in parallel, it is difficult and expensive to build an associative cache that is both large and fast. As a result, fully associative caches are only appropriate for small caches, such as the translation lookaside buffers (TLBs) in virtual memory systems that cache page table entries ([Section 9.6.2](#)).

## Practice Problem 6.12 (solution page [663](#))

The problems that follow will help reinforce your understanding of how caches work. Assume the following:

- The memory is byte addressable.
- Memory accesses are to 1-byte words (not to 4-byte words).
- Addresses are 13 bits wide.
- The cache is two-way set associative ( $E = 2$ ), with a 4-byte block size ( $B = 4$ ) and eight sets ( $S = 8$ ).

The contents of the cache are as follows, with all numbers given in hexadecimal notation.

The following figure shows the format of an address (1 bit per box). Indicate (by labeling the diagram) the fields that would be used to determine the following:

CO. The cache block offset

CI. The cache set index

CT. The cache tag

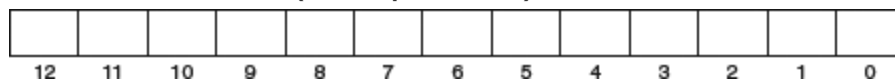


## Practice Problem 6.13 (solution page [664](#))

Suppose a program running on the machine in [Problem 6.12](#) references the 1-byte word at address `0x0E34`.

Indicate the cache entry accessed and the cache byte value returned in hexadecimal notation. Indicate whether a cache miss occurs. If there is a cache miss, enter "—" for "Cache byte returned."

A. Address format (1 bit per box):



B. Memory reference:

## Practice Problem 6.14 (solution page 664)

Repeat [Problem 6.13](#) for memory address `0x0DD5`.

A. Address format (1 bit per box):

12	11	10	9	8	7	6	5	4	3	2	1	0

B. Memory reference:

## Practice Problem 6.15 (solution page 664)

Repeat [Problem 6.13](#) for memory address `0x1FE4`.

A. Address format (1 bit per box):

12	11	10	9	8	7	6	5	4	3	2	1	0

B. Memory reference:

## Practice Problem 6.16 (solution page 665)

For the cache in [Problem 6.12](#), list all of the hexadecimal memory addresses that will hit in set 3.

## 6.4.5 Issues with Writes

As we have seen, the operation of a cache with respect to reads is straightforward. First, look for a copy of the desired word  $w$  in the cache. If there is a hit, return  $w$  immediately. If there is a miss, fetch the block that contains  $w$  from the next lower level of the memory hierarchy, store the block in some cache line (possibly evicting a valid line), and then return  $w$ .

The situation for writes is a little more complicated. Suppose we write a word  $w$  that is already cached (a *write hit*). After the cache updates its copy of  $w$ , what does it do about updating the copy of  $w$  in the next lower level of the hierarchy? The simplest approach, known as *write-through*, is to immediately write  $w$ 's cache block to the next lower level. While simple, write-through has the disadvantage of causing bus traffic with every write. Another approach, known as *write-back*, defers the update as long as possible by writing the updated block to the next lower level only when it is evicted from the cache by the replacement algorithm. Because of locality, write-back can significantly reduce the amount of bus traffic, but it has the disadvantage of additional complexity. The cache must maintain an additional *dirty bit* for each cache line that indicates whether or not the cache block has been modified.

Another issue is how to deal with write misses. One approach, known as *write-allocate*, loads the corresponding block from the next lower level into the cache and then updates the cache block. Write-





allocate tries to exploit spatial locality of writes, but it has the disadvantage that every miss results in a block transfer from the next lower level to the cache. The alternative, known as *no-write-allocate*, bypasses the cache and writes the word directly to the next lower level. Write-through caches are typically no-write-allocate. Write-back caches are typically write-allocate.

Optimizing caches for writes is a subtle and difficult issue, and we are only scratching the surface here. The details vary from system to system and are often proprietary and poorly documented. To the programmer trying to write reasonably cache-friendly programs, we suggest adopting a mental model that assumes write-back, write-allocate caches. There are several reasons for this suggestion: As a rule, caches at lower levels of the memory hierarchy are more likely to use write-back instead of write-through because of the larger transfer times. For example, virtual memory systems (which use main memory as a cache for the blocks stored on disk) use write-back exclusively. But as logic densities increase, the increased complexity of write-back is becoming less of an impediment and we are seeing write-back caches at all levels of modern systems. So this assumption matches current trends. Another reason for assuming a write-back, write-allocate approach is that it is symmetric to the way reads are handled, in that write-back write-allocate tries to exploit locality. Thus, we can develop our programs at a high level to exhibit good spatial and temporal locality rather than trying to optimize for a particular memory system.

## 6.4.6 Anatomy of a Real Cache Hierarchy

So far, we have assumed that caches hold only program data. But, in fact, caches can hold instructions as well as data. A cache that holds instructions only is called an *i-cache*. A cache that holds program data only is called a *d-cache*. A cache that holds both instructions and data is known as a *unified cache*. Modern processors include separate i-caches and d-caches. There are a number of reasons for this. With two separate caches, the processor can read an instruction word and a data word at the same time. I-caches are typically read-only, and thus simpler. The two caches are often optimized to different access patterns and can have different block sizes, associativities, and capacities. Also, having separate caches ensures that data accesses do not create conflict misses with instruction accesses, and vice versa, at the cost of a potential increase in capacity misses.

**Figure 6.38**  shows the cache hierarchy for the Intel Core i7 processor. Each CPU chip has four cores. Each core has its own private L1 i-cache, L1 d-cache, and L2 unified cache. All of the cores share an on-chip L3 unified cache. An interesting feature of this hierarchy is that all of the SRAM cache memories are contained in the CPU chip.

**Figure 6.39**  summarizes the basic characteristics of the Core i7 caches.

## 6.4.7 Performance Impact of Cache Parameters

Cache performance is evaluated with a number of metrics:

**Miss rate.** The fraction of memory references during the execution of a program, or a part of a program, that miss. It is computed as  $\# \text{ misses} / \# \text{ references}$ .

**Hit rate.** The fraction of memory references that hit. It is computed as  $1 - \text{miss rate}$ .

**Hit time.** The time to deliver a word in the cache to the CPU, including the time for set selection, line identification, and word selection. Hit time is on the order of several clock cycles for L1 caches.

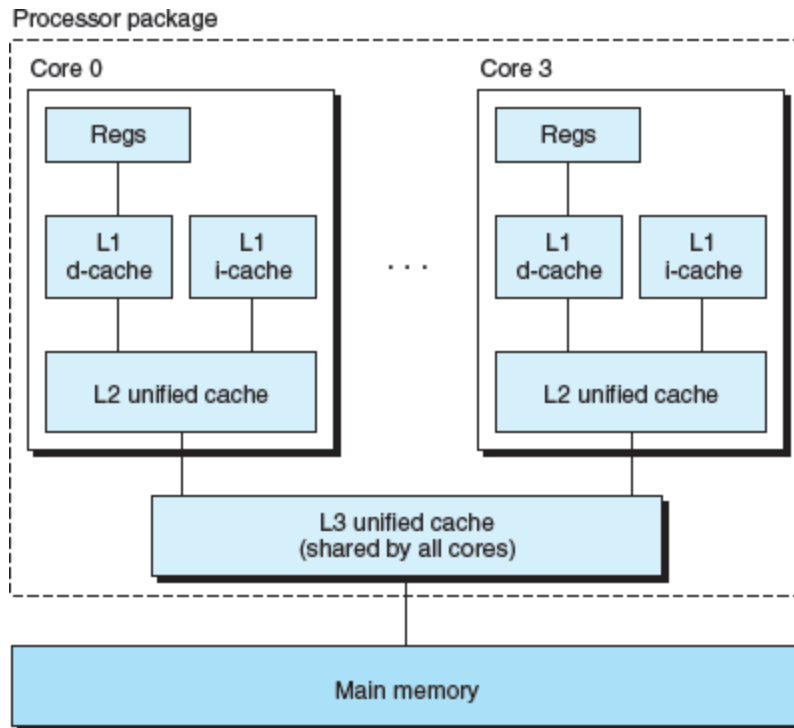


Figure 6.38 Intel Core i7 cache hierarchy.

Figure 6.39 Characteristics of the Intel Core i7 cache hierarchy.

**Miss penalty.** Any additional time required because of a miss. The penalty for L1 misses served from L2 is on the order of 10 cycles; from L3, 50 cycles; and from main memory, 200 cycles.

Optimizing the cost and performance trade-offs of cache memories is a subtle exercise that requires extensive simulation on realistic benchmark codes and thus is beyond our scope. However, it is possible to identify some of the qualitative trade-offs.

## *Impact of Cache Size*

On the one hand, a larger cache will tend to increase the hit rate. On the other hand, it is always harder to make large memories run faster. As a result, larger caches tend to increase the hit time. This explains why an L1 cache is smaller than an L2 cache, and an L2 cache is smaller than an L3 cache.

## *Impact of Block Size*

Large blocks are a mixed blessing. On the one hand, larger blocks can help increase the hit rate by exploiting any spatial locality that might exist in a program. However, for a given cache size, larger blocks imply a smaller number of cache lines, which can hurt the hit rate in programs with more temporal locality than spatial locality. Larger blocks also have a negative impact on the miss penalty, since larger blocks cause larger transfer times. Modern systems such as the Core i7 compromise with cache blocks that contain 64 bytes.

## *Impact of Associativity*

The issue here is the impact of the choice of the parameter  $E$ , the number of cache lines per set. The advantage of higher associativity (i.e., larger values of  $E$ ) is that it decreases the vulnerability of the cache to thrashing due to conflict misses. However, higher associativity comes at a significant cost. Higher associativity is expensive to implement and hard to make fast. It requires more tag bits per line, additional LRU state bits per line, and additional control logic. Higher associativity can increase hit time, because of the increased complexity, and it can also increase the miss penalty because of the increased complexity of choosing a victim line.

The choice of associativity ultimately boils down to a trade-off between the hit time and the miss penalty. Traditionally, high-performance systems that pushed the clock rates would opt for smaller associativity for L1 caches (where the miss penalty is only a few cycles) and a higher degree of associativity for the lower levels, where the miss penalty is higher. For example, in Intel Core i7 systems, the L1 and L2 caches are 8-way associative, and the L3 cache is 16-way.

## *Impact of Write Strategy*

Write-through caches are simpler to implement and can use a *write buffer* that works independently of the cache to update memory. Furthermore, read misses are less expensive because they do not trigger a memory write. On the other hand, write-back caches result in fewer transfers, which allows more bandwidth to memory for I/O devices that perform DMA. Further, reducing the number of transfers becomes increasingly important as we move down the hierarchy and the transfer times increase. In general, caches further down the hierarchy are more likely to use write-back than write-through.

[OceanofPDF.com](http://OceanofPDF.com)



## 6.5 Writing Cache-Friendly Code

In [Section 6.2](#), we introduced the idea of locality and talked in qualitative terms about what constitutes good locality. Now that we understand how cache memories work, we can be more precise. Programs with better locality will tend to have lower miss rates, and programs with lower miss rates will tend to run faster than programs with higher miss rates. Thus, good programmers should always try to

# Aside Cache lines, sets, and blocks:

## What's the difference?

It is easy to confuse the distinction between cache lines, sets, and blocks. Let's review these ideas and make sure they are clear:

- A *block* is a fixed-size packet of information that moves back and forth between a cache and main memory (or a lower-level cache).
- A *line* is a container in a cache that stores a block, as well as other information such as the valid bit and the tag bits.
- A *set* is a collection of one or more lines. Sets in direct-mapped caches consist of a single line. Sets in set associative and fully associative caches consist of multiple lines.

In direct-mapped caches, sets and lines are indeed equivalent. However, in associative caches, sets and lines are very different things and the terms cannot be used interchangeably.

Since a line always stores a single block, the terms "line" and "block" are often used interchangeably. For example, systems professionals usually refer to the "line size" of a cache, when what they really mean is the block size. This usage is very common and shouldn't cause any confusion as long as you understand the distinction between blocks and lines.

write code that is *cache friendly*, in the sense that it has good locality. Here is the basic approach we use to try to ensure that our code is cache friendly.

1. **Make the common case go fast.** Programs often spend most of their time in a few core functions. These functions often spend most of their time in a few loops. So focus on the inner loops of the core functions and ignore the rest.
2. **Minimize the number of cache misses in each inner loop.** All other things being equal, such as the total number of loads and stores, loops with better miss rates will run faster.

To see how this works in practice, consider the `sumvec` function from [Section 6.2](#):

```
1 int sumvec (int v[N])
2 {
3     int i, sum = 0 ;
4
5     for (i = 0; i < N; i++)
6         sum += v[i];
7     return sum;
8 }
```

Is this function cache friendly? First, notice that there is good temporal locality in the loop body with respect to the local variables

`i` and `sum`. In fact, because these are local variables, any reasonable optimizing compiler will cache them in the register file, the highest level of the memory hierarchy. Now consider the stride-1 references to vector `v`. In general, if a cache has a block size of  $B$  bytes, then a stride- $k$  reference pattern (where  $k$  is expressed in words) results in an average of  $\min(1, (\text{word size} \times k)/B)$  misses per loop iteration. This is minimized for  $k = 1$ , so the stride-1 references to `v` are indeed cache friendly. For example, suppose that `v` is block aligned, words are 4 bytes, cache blocks are 4 words, and the cache is initially empty (a cold cache). Then, regardless of the cache organization, the references to `v` will result in the following pattern of hits and misses:

In this example, the reference to `v[0]` misses and the corresponding block, which contains `v[0]-v[3]`, is loaded into the cache from memory. Thus, the next three references are all hits. The reference to `v[4]` causes another miss as a new block is loaded into the cache, the next three references are hits, and so on. In general, three out of four references will hit, which is the best we can do in this case with a cold cache.

To summarize, our simple `sumvec` example illustrates two important points about writing cache-friendly code:

- Repeated references to local variables are good because the compiler can cache them in the register file (temporal locality).

- Stride-1 reference patterns are good because caches at all levels of the memory hierarchy store data as contiguous blocks (spatial locality).

Spatial locality is especially important in programs that operate on multidimensional arrays. For example, consider the `sumarrayrows` function from [Section 6.2](#), which sums the elements of a two-dimensional array in row-major order:

```
1  int sumarrayrows(int a[M][N])
2  {
3      int i, j, sum = 0;
4
5      for (i = 0; i < M; i++)
6          for (j = 0; j < N; j++)
7              sum += a[i][j];
8      return sum;
9  }
```

Since C stores arrays in row-major order, the inner loop of this function has the same desirable stride-1 access pattern as `sumvec`. For example, suppose we make the same assumptions about the cache as for `sumvec`. Then the references to the array `a` will result in the following pattern of hits and misses:

But consider what happens if we make the seemingly innocuous change of permuting the loops:

```
1 int sumarraycols(int a[M][N])
2 {
3     int i, j, sum = 0;
4
5     for (j = 0; j < N; j++)
6         for (i = 0; i < M; i++)
7             sum += a[i][j];
8     return sum;
9 }
```

In this case, we are scanning the array column by column instead of row by row. If we are lucky and the entire array fits in the cache, then we will enjoy the same miss rate of  $1/4$ . However, if the array is larger than the cache (the more likely case), then each and every access of `a[i][j]` will miss!

Higher miss rates can have a significant impact on running time. For example, on our desktop machine, `sumarrayrows` runs 25 times faster than `sumarraycols` for large array sizes. To summarize, programmers should be aware of locality in their programs and try to write programs that exploit it.

# Practice Problem 6.17 (solution page 665)

Transposing the rows and columns of a matrix is an important problem in signal processing and scientific computing applications. It is also interesting from a locality point of view because its reference pattern is both row-wise and column-wise. For example, consider the following transpose routine:

```
1     typedef int array[2][2];
2
3     void transpose1(array dst, array src)
4     {
5         int i, j;
6
7         for (i = 0; i < 2; i++) {
8             for (j = 0; j < 2; j++) {
9                 dst[j][i] = src[i][j];
10            }
11        }
12    }
```

Assume this code runs on a machine with the following properties:

- `sizeof(int) = 4`.



- The `src` array starts at address 0 and the `dst` array starts at address 16 (decimal).
- There is a single L1 data cache that is direct-mapped, write-through, and write-allocate, with a block size of 8 bytes.
- The cache has a total size of 16 data bytes and the cache is initially empty.
- Accesses to the `src` and `dst` arrays are the only sources of read and write misses, respectively.

A. For each `row` and `col`, indicate whether the access to `src[row][col]` and `dst[row][col]` is a hit (h) or a miss (m). For example, reading `src[0][0]` is a miss and writing `dst[0][0]` is also a miss.

B. Repeat the problem for a cache with 32 data bytes.

# Practice Problem 6.18 (solution page 666)

The heart of the recent hit game *SimAquarium* is a tight loop that calculates the average position of 256 algae. You are evaluating its cache performance on a machine with a 1,024-byte direct-mapped data cache with 16-byte blocks ( $B = 16$ ). You are given the following definitions:

```
1 struct algae_position {
2     int x;
3     int y;
4 };
5
6 struct algae_position grid[16][16];
7 int total_x = 0, total_y = 0;
8 int i, j;
```

You should also assume the following:

- `sizeof(int) = 4`.
- `grid` begins at memory address 0.
- The cache is initially empty.
- The only memory accesses are to the entries of the array `grid`. Variables `i`, `j`, `total_x`, and `total_y` are stored in registers.

Determine the cache performance for the following code:

```
|  
1     for (i = 0; i < 16; i++) {  
2         for (j = 0; j < 16; j++) {  
3             total_x += grid[i][j].x;  
4         }  
5     }  
6  
7     for (i = 0; i < 16; i++) {  
8         for (j = 0; j < 16; j++) {  
9             total_y += grid[i][j].y;  
10        }  
11    }
```

- A. What is the total number of reads?
- B. What is the total number of reads that miss in the cache?
- C. What is the miss rate?

# Practice Problem 6.19 (solution page 666)

Given the assumptions of [Practice Problem 6.18](#), determine the cache performance of the following code:

```
1     for (i = 0; i < 16; i++){
2         for (j = 0; j < 16; j++) {
3             total_x += grid[j][i].x;
4             total_y += grid[j][i].y;
5         }
6     }
```

- What is the total number of reads?
- What is the total number of reads that miss in the cache?
- What is the miss rate?
- What would the miss rate be if the cache were twice as big?

# Practice Problem 6.20 (solution page **666**)

Given the assumptions of [Practice Problem 6.18](#), determine the cache performance of the following code:

```
1     for (i = 0; i < 16; i++){
2         for (j = 0; j < 16; j++) {
3             total_x += grid[i][j].x;
4             total_y += grid[i][j].y;
5         }
6     }
```


- A. What is the total number of reads?
- B. What is the total number of reads that miss in the cache?
- C. What is the miss rate?
- D. What would the miss rate be if the cache were twice as big?


## 6.6 Putting It Together: The Impact of Caches on Program Performance

This section wraps up our discussion of the memory hierarchy by studying the impact that caches have on the performance of programs running on real machines.

## 6.6.1 The Memory Mountain


The rate that a program reads data from the memory system is called the *read throughput*, or sometimes the *read bandwidth*. If a program reads  $n$  bytes over a period of  $s$  seconds, then the read throughput over that period is  $n/s$ , typically expressed in units of megabytes per second (MB/s).

If we were to write a program that issued a sequence of read requests from a tight program loop, then the measured read throughput would give us some insight into the performance of the memory system for that particular sequence of reads. [Figure 6.40](#)  shows a pair of functions that measure the read throughput for a particular read sequence.

The `test` function generates the read sequence by scanning the first `elems` elements of an array with a stride of `stride`. To increase the available parallelism in the inner loop, it uses  $4 \times 4$  unrolling ([Section 5.9](#) ). The `run` function is a wrapper that calls the `test` function and returns the measured read throughput. The call to the `test` function in line 37 warms the cache. The `fcyc2` function in line 38 calls the `test` function with arguments `elems` and estimates the running time of the `test` function in CPU cycles. Notice that the `size` argument to the `run` function is in units of bytes, while the corresponding `elems` argument to the `test` function is in units of

array elements. Also, notice that line 39 computes MB/s as  $10^6$  bytes/s, as opposed to  $2^{20}$  bytes/s.

The `size` and `stride` arguments to the `run` function allow us to control the degree of temporal and spatial locality in the resulting read sequence. Smaller values of `size` result in a smaller working set size, and thus better temporal locality. Smaller values of `stride` result in better spatial locality. If we call the `run` function repeatedly with different values of `size` and `stride`, then we can recover a fascinating two-dimensional function of read throughput versus temporal and spatial locality. This function is called a *memory mountain* [112].

Every computer has a unique memory mountain that characterizes the capabilities of its memory system. For example, [Figure 6.41](#)  shows the memory mountain for an Intel Core i7 Haswell system. In this example, the `size` varies from 16 KB to 128 MB, and the `stride` varies from 1 to 12 elements, where each element is an 8-byte `long int`.



-----

*code/mem/mountain/mountain.c*

```

1 long data[MAXELEMS]; /* The global array we'll be traversing
*/
2
3 /* test - Iterate over first "elems" elements of array
"data" with
4 * stride of "stride", using 4 x 4 loop
unrolling.
5 */
6 int test(int elems, int stride)
7 {
8     long i, sx2 = stride*2, sx3 = stride*3, sx4 =
stride*4;
9     long acc0 = 0, acc1 = 0, acc2 = 0, acc3 = 0;
10    long length = elems;
11    long limit = length - sx4;
12
13    /* Combine 4 elements at a time */
14    for (i = 0; i < limit; i += sx4) {
15        acc0 = acc0 + data[i];
16        acc1 = acc1 + data[i+stride];
17        acc2 = acc2 + data[i+sx2];
18        acc3 = acc3 + data[i+sx3];
19    }
20
21    /* Finish any remaining elements */
22    for (; i < length; i++) {
23        acc0 = acc0 + data[i];

```

```

24     }
25     return ((acc0 + acc1) + (acc2 + acc3));
26 }
27
28 /* run - Run test(elems, stride) and return read
throughput (MB/s).
29 * "size" is in bytes, "stride" is in array
elements, and Mhz is
30 * CPU clock frequency in Mhz.
31 */
32 double run(int size, int stride, double Mhz)
33 {
34     double cycles;
35     int elems = size / sizeof(double);
36
37     test(elems, stride); /* Warm up the cache */
38     cycles = fcyc2(test, elems, stride, 0); /* Call
test(elems, stride) */
39     return (size / stride) / (cycles / Mhz); /*
Convert cycles to MB/s */
40 }

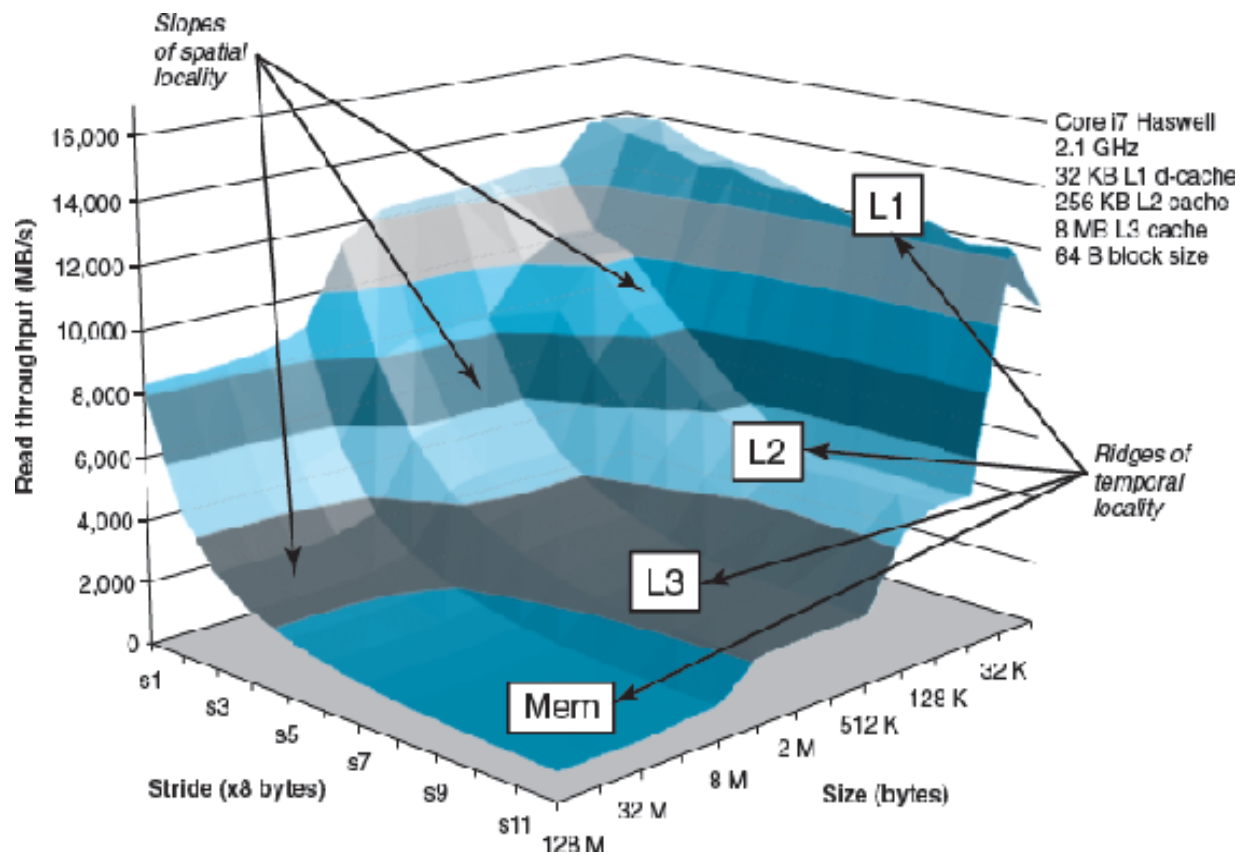
```

---

*code/mem/mountain/mountain.c*

**Figure 6.40** Functions that measure and compute read throughput.

We can generate a memory mountain for a particular computer by calling the `run` function with different values of `size` (which corresponds to temporal locality) and `stride` (which corresponds to spatial locality).



**Figure 6.41** A memory mountain.

Shows read throughput as a function of temporal and spatial locality.

The geography of the Core i7 mountain reveals a rich structure.

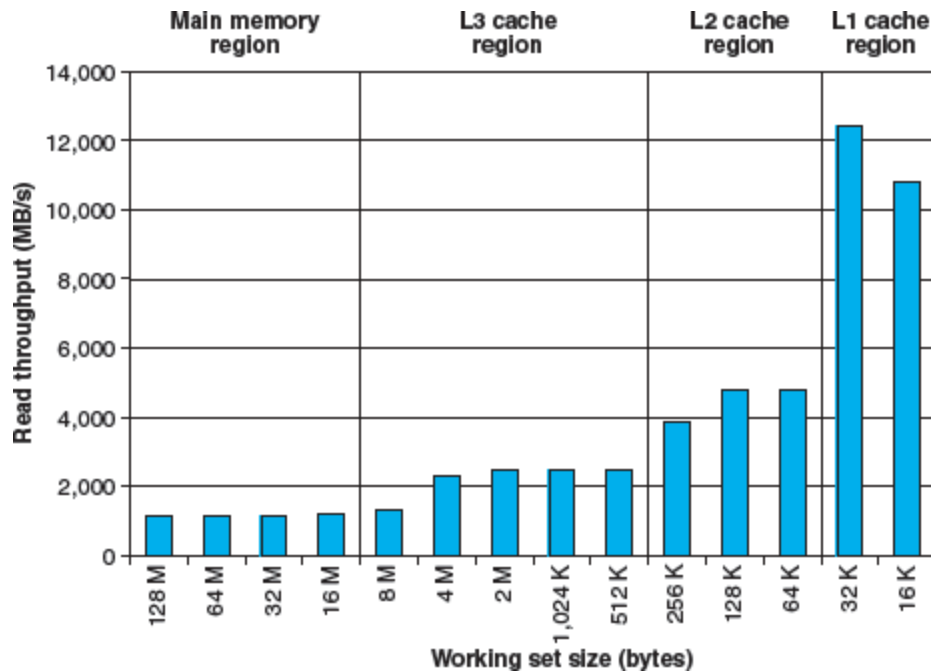
Perpendicular to the `size` axis are four *ridges* that correspond to the regions of temporal locality where the working set fits entirely in the L1 cache, L2 cache, L3 cache, and main memory, respectively.

Notice that there is more than an order of magnitude difference

between the highest peak of the L1 ridge, where the CPU reads at a rate of over 14 GB/s, and the lowest point of the main memory ridge, where the CPU reads at a rate of 900 MB/s.

On each of the L2, L3, and main memory ridges, there is a slope of spatial locality that falls downhill as the stride increases and spatial locality decreases. Notice that even when the working set is too large to fit in any of the caches, the highest point on the main memory ridge is a factor of 8 higher than its lowest point. So even when a program has poor temporal locality, spatial locality can still come to the rescue and make a significant difference.

There is a particularly interesting flat ridge line that extends perpendicular to the stride axis for a stride of 1, where the read throughput is a relatively flat 12 GB/s, even though the working set exceeds the capacities of L1 and L2. This is apparently due to a hardware *prefetching* mechanism in the Core i7 memory system that automatically identifies sequential stride-1 reference patterns and attempts to fetch those blocks into the cache before they are accessed. While the



**Figure 6.42 Ridges of temporal locality in the memory mountain.**

The graph shows a slice through [Figure 6.41](#) with `stride = 8`.

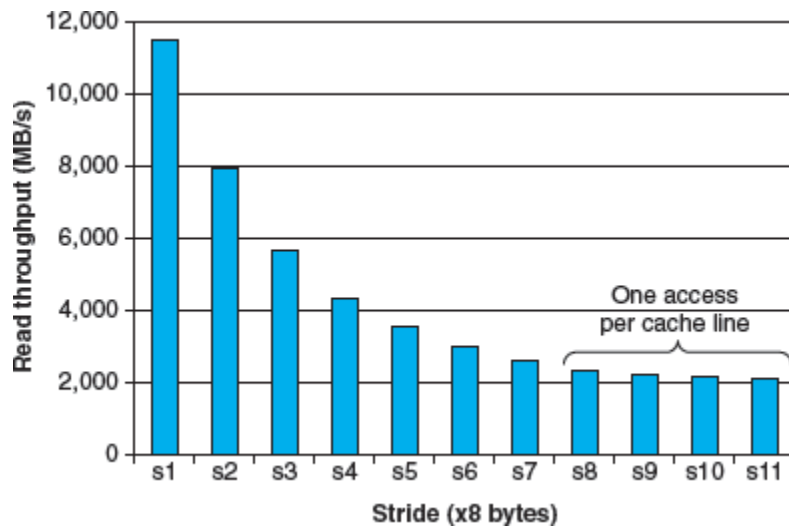
details of the particular prefetching algorithm are not documented, it is clear from the memory mountain that the algorithm works best for small strides—yet another reason to favor sequential stride-1 accesses in your code.

If we take a slice through the mountain, holding the stride constant as in [Figure 6.42](#), we can see the impact of cache size and temporal locality on performance. For sizes up to 32 KB, the working set fits entirely in the L1 d-cache, and thus reads are served from L1 at throughput of about 12 GB/s. For sizes up to 256 KB, the working set fits entirely in the unified L2 cache, and for sizes up to 8 MB, the working set fits entirely in the unified L3 cache. Larger working set sizes are served primarily from main memory.

The dips in read throughputs at the leftmost edges of the L2 and L3 cache regions—where the working set sizes of 256 KB and 8 MB are equal to their respective cache sizes—are interesting. It is not entirely clear why these dips occur. The only way to be sure is to perform a detailed cache simulation, but it is likely that the drops are caused by conflicts with other code and data lines.

Slicing through the memory mountain in the opposite direction, holding the working set size constant, gives us some insight into the impact of spatial locality on the read throughput. For example, [Figure 6.43](#) shows the slice for a fixed working set size of 4 MB. This slice cuts along the L3 ridge in [Figure 6.41](#), where the working set fits entirely in the L3 cache but is too large for the L2 cache.

Notice how the read throughput decreases steadily as the stride increases from one to eight words. In this region of the mountain, a read miss in L2 causes a block to be transferred from L3 to L2. This is followed by some number of hits



**Figure 6.43 A slope of spatial locality.**

The graph shows a slice through [Figure 6.41](#) with `size` = 4 MB.


on the block in L2, depending on the stride. As the stride increases, the ratio of L2 misses to L2 hits increases. Since misses are served more slowly than hits, the read throughput decreases. Once the stride reaches eight 8-byte words, which on this system equals the block size of 64 bytes, every read request misses in L2 and must be served from L3. Thus, the read throughput for strides of at least eight is a constant rate determined by the rate that cache blocks can be transferred from L3 into L2.

To summarize our discussion of the memory mountain, the performance of the memory system is not characterized by a single number. Instead, it is a mountain of temporal and spatial locality whose elevations can vary by over an order of magnitude. Wise programmers try to structure their programs so that they run in the peaks instead of the valleys. The aim is to exploit temporal locality so that heavily used words are fetched from the L1 cache, and to



exploit spatial locality so that as many words as possible are accessed from a single L1 cache line.

## *Practice Problem 6.21 (solution page 666)*

Use the memory mountain in [Figure 6.41](#)  to estimate the time, in CPU cycles, to read an 8-byte word from the L1 d-cache.

## 6.6.2 Rearranging Loops to Increase Spatial Locality

Consider the problem of multiplying a pair of  $n \times n$  matrices:  $C = AB$ . For example, if  $n = 2$ , then

$$\begin{bmatrix} c_{11} & c_{12} \\ c_{21} & c_{22} \end{bmatrix} = \begin{bmatrix} a_{11} & a_{12} \\ a_{21} & a_{22} \end{bmatrix} \begin{bmatrix} b_{11} & b_{12} \\ b_{21} & b_{22} \end{bmatrix}$$

where

$$c_{11} = a_{11}b_{11} + a_{12}b_{21}$$

$$c_{12} = a_{11}b_{12} + a_{12}b_{22}$$

$$c_{21} = a_{21}b_{11} + a_{22}b_{21}$$

$$c_{22} = a_{21}b_{12} + a_{22}b_{22}$$

A matrix multiply function is usually implemented using three nested loops, which are identified by their indices  $i$ ,  $j$ , and  $k$ . If we permute the loops and make some other minor code changes, we can create the six functionally equivalent versions of matrix multiply shown in [Figure 6.44](#). Each version is uniquely identified by the ordering of its loops.

At a high level, the six versions are quite similar. If addition is associative, then each version computes an identical result.<sup>1</sup> Each version performs  $O(n^3)$  total operations and an identical number of



adds and multiplies. Each of the  $n^2$  elements of  $A$  and  $B$  is read  $n$  times. Each of the  $n^2$  elements of  $C$  is computed by summing  $n$  values. However, if we analyze the behavior of the innermost loop iterations, we find that there are differences in the number of accesses and the locality. For the purposes of this analysis, we make the following assumptions:



1. As we learned in [Chapter 2](#), floating-point addition is commutative, but in general not associative. In practice, if the matrices do not mix extremely large values with extremely small ones, as often is true when the matrices store physical properties, then the assumption of associativity is reasonable.

- Each array is an  $n \times n$  array of `double`, with `sizeof(double) = 8`.
- There is a single cache with a 32-byte block size ( $B = 32$ ).
- The array size  $n$  is so large that a single matrix row does not fit in the L1 cache.
- The compiler stores local variables in registers, and thus references to local variables inside loops do not require any load or store instructions.

[Figure 6.45](#) summarizes the results of our inner-loop analysis. Notice that the six versions pair up into three equivalence classes, which we denote by the pair of matrices that are accessed in the inner loop. For example, versions  $ijk$  and  $jik$  are members of class  $AB$  because they reference arrays  $A$  and  $B$  (but not  $C$ ) in their innermost loop. For each class, we have counted the number of loads (reads) and stores (writes) in each inner-loop iteration, the number of references to  $A$ ,  $B$ , and  $C$  that will miss in the cache in

each loop iteration, and the total number of cache misses per iteration.

The inner loops of the class *AB* routines ([Figure 6.44\(a\)](#)  and [\(b\)](#) ) scan a row of array *A* with a stride of 1. Since each cache block holds four 8-byte words, the miss rate for *A* is 0.25 misses per iteration. On the other hand, the inner loop scans a column of *B* with a stride of *n*. Since *n* is large, each access of array *B* results in a miss, for a total of 1.25 misses per iteration.

The inner loops in the class *AC* routines ([Figure 6.44\(c\)](#)  and [\(d\)](#) ) have some problems. Each iteration performs two loads and a store (as opposed to the

(a) Version *ijk*

----- *code/mem/matmult/mm.c*

```
|  
1   for (i = 0; i < n; i++)  
2   for (j = 0; j < n; j++) {  
3   sum = 0.0;  
4   for (k = 0; k < n; k++)  
5   sum += A[i][k]*B[k][j];  
6   C[i][j] += sum;  
7   }
```

----- *code/mem/matmult/mm.c*

(b) Version *jik*

----- *code/mem/matmult/mm.c*

```
|  
1     for (j = 0; j < n; j++)  
2     for (i = 0; i < n; i++) {  
3     sum = 0.0;  
4     for (k = 0; k < n; k++)  
5     sum += A[i][k]*B[k][j];  
6     C[i][j] += sum;  
7     }
```

----- *code/mem/matmult/mm.c*

(c) Version *jki*

----- *code/mem/matmult/mm.c*

```
|  
1     for (j = 0; j < n; j++)  
2     for (k = 0; k < n; k++) {  
3     r = B[k][j];  
4     for (i = 0; i < n; i++)  
5     C[i][j] += A[i][k]*r;  
6     }
```

----- *code/mem/matmult/mm.c*

(d) Version *kji*

----- *code/mem/matmult/mm.c*

```
|  
1     for (k = 0; k < n; k++)  
2     for (j = 0; j < n; j++) {  
3         r = B[k][j];  
4         for (i = 0; i < n; i++)  
5             C[i][j] += A[i][k]*r;  
6     }
```

----- *code/mem/matmult/mm.c*

(e) Version *kij*

----- *code/mem/matmult/mm.c*

```
|  
1     for (k = 0; k < n; k++)  
2         for (i = 0; i < n; i++) {  
3             r = A[i][k];  
4             for (j = 0; j < n; j++)  
5                 C[i][j] += r*B[k][j];  
6         }
```

----- *code/mem/matmult/mm.c*

(f) Version *ikj*

----- *code/mem/matmult/mm.c*

```
|  
1   for (i = 0; i < n; i++)  
2   for (k = 0; k < n; k++) {  
3   r = A[i][k];  
4   for (j = 0; j < n; j++)  
5   C[i][j] += r*B[k][j];  
6   }
```

----- *code/mem/matmult/mm.c*

**Figure 6.44 Six versions of matrix multiply.**

Each version is uniquely identified by the ordering of its loops.

**Figure 6.45 Analysis of matrix multiply inner loops.**

The six versions partition into three equivalence classes, denoted by the pair of arrays that are accessed in the inner loop.



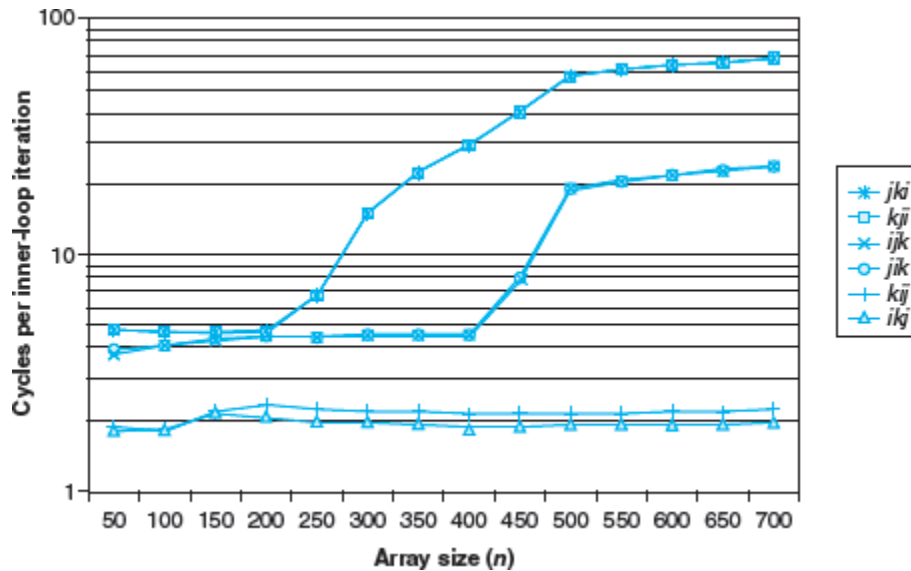


Figure 6.46 Core i7 matrix multiply performance.

class *AB* routines, which perform two loads and no stores). Second, the inner loop scans the columns of *A* and *C* with a stride of *n*. The result is a miss on each load, for a total of two misses per iteration. Notice that interchanging the loops has decreased the amount of spatial locality compared to the class *AB* routines.

The *BC* routines (Figure 6.44(e) and (f)) present an interesting trade-off: With two loads and a store, they require one more memory operation than the *AB* routines. On the other hand, since the inner loop scans both *B* and *C* row-wise with a stride-1 access pattern, the miss rate on each array is only 0.25 misses per iteration, for a total of 0.50 misses per iteration.

Figure 6.46 summarizes the performance of different versions of matrix multiply on a Core i7 system. The graph plots the measured

number of CPU cycles per inner-loop iteration as a function of array size ( $n$ ).

There are a number of interesting points to notice about this graph:

- For large values of  $n$ , the fastest version runs almost 40 times faster than the slowest version, even though each performs the same number of floating-point arithmetic operations.
- Pairs of versions with the same number of memory references and misses per iteration have almost identical measured performance.
- The two versions with the worst memory behavior, in terms of the number of accesses and misses per iteration, run significantly slower than the other four versions, which have fewer misses or fewer accesses, or both.
- Miss rate, in this case, is a better predictor of performance than the total number of memory accesses. For example, the class *BC* routines, with 0.5 misses per iteration, perform much better than the class *AB* routines, with 1.25 misses per iteration, even though the class *BC* routines perform more

# Web Aside MEM:BLOCKING

## Using blocking to increase temporal locality

There is an interesting technique called *blocking* that can improve the temporal locality of inner loops. The general idea of blocking is to organize the data structures in a program into large chunks called *blocks*. (In this context, "block" refers to an application-level chunk of data, *not* to a cache block.) The program is structured so that it loads a chunk into the L1 cache, does all the reads and writes that it needs to on that chunk, then discards the chunk, loads in the next chunk, and so on.

Unlike the simple loop transformations for improving spatial locality, blocking makes the code harder to read and understand. For this reason, it is best suited for optimizing compilers or frequently executed library routines. Blocking does not improve the performance of matrix multiply on the Core i7, because of its sophisticated prefetching hardware. Still, the technique is interesting to study and understand because it is a general concept that can produce big performance gains on systems that don't prefetch.

memory references in the inner loop (two loads and one store) than the class *AB* routines (two loads).

- For large values of  $n$ , the performance of the fastest pair of versions ( $kij$  and  $ikj$ ) is constant. Even though the array is much larger than any of the SRAM cache memories, the prefetching hardware is smart enough to recognize the stride-1 access pattern, and fast enough to keep up with memory accesses in the tight inner loop. This is a stunning accomplishment by the Intel engineers who designed this memory system, providing even more incentive for programmers to develop programs with good spatial locality.

## 6.6.3 Exploiting Locality in Your Programs

As we have seen, the memory system is organized as a hierarchy of storage devices, with smaller, faster devices toward the top and larger, slower devices toward the bottom. Because of this hierarchy, the effective rate that a program can access memory locations is not characterized by a single number. Rather, it is a wildly varying function of program locality (what we have dubbed the memory mountain) that can vary by orders of magnitude. Programs with good locality access most of their data from fast cache memories. Programs with poor locality access most of their data from the relatively slow DRAM main memory.

Programmers who understand the nature of the memory hierarchy can exploit this understanding to write more efficient programs, regardless of the specific memory system organization. In particular, we recommend the following techniques:

- Focus your attention on the inner loops, where the bulk of the computations and memory accesses occur.
- Try to maximize the spatial locality in your programs by reading data objects sequentially, with stride 1, in the order they are stored in memory.
- Try to maximize the temporal locality in your programs by using a data object as often as possible once it has been read from

memory.

[OceanofPDF.com](http://OceanofPDF.com)

## 6.7 Summary

The basic storage technologies are random access memories (RAMs), nonvolatile memories (ROMs), and disks. RAM comes in two basic forms. Static RAM (SRAM) is faster and more expensive and is used for cache memories. Dynamic RAM (DRAM) is slower and less expensive and is used for the main memory and graphics frame buffers. ROMs retain their information even if the supply voltage is turned off. They are used to store firmware. Rotating disks are mechanical nonvolatile storage devices that hold enormous amounts of data at a low cost per bit, but with much longer access times than DRAM. Solid state disks (SSDs) based on nonvolatile flash memory are becoming increasingly attractive alternatives to rotating disks for some applications.

In general, faster storage technologies are more expensive per bit and have smaller capacities. The price and performance properties of these technologies are changing at dramatically different rates. In particular, DRAM and disk access times are much larger than CPU cycle times. Systems bridge these gaps by organizing memory as a hierarchy of storage devices, with smaller, faster devices at the top and larger, slower devices at the bottom. Because well-written programs have good locality, most data are served from the higher levels, and the effect is a memory system that runs at the rate of the higher levels, but at the cost and capacity of the lower levels.

Programmers can dramatically improve the running times of their programs by writing programs with good spatial and temporal locality. Exploiting SRAM-based cache memories is especially important. Programs that fetch data primarily from cache memories can run much faster than programs that fetch data primarily from memory.

[OceanofPDF.com](http://OceanofPDF.com)



# Bibliographic Notes

Memory and disk technologies change rapidly. In our experience, the best sources of technical information are the Web pages maintained by the manufacturers. Companies such as Micron, Toshiba, and Samsung provide a wealth of current technical information on memory devices. The pages for Seagate and Western Digital provide similarly useful information about disks.

Textbooks on circuit and logic design provide detailed information about memory technology [58, 89]. *IEEE Spectrum* published a series of survey articles on DRAM [55]. The International Symposiums on Computer Architecture (ISCA) and High Performance Computer Architecture (HPCA) are common forums for characterizations of DRAM memory performance [28, 29, 18].

Wilkes wrote the first paper on cache memories [117]. Smith wrote a classic survey [104]. Przybylski wrote an authoritative book on cache design [86]. Hennessy and Patterson provide a comprehensive discussion of cache design issues [46]. Levinthal wrote a comprehensive performance guide for the Intel Core i7 [70].

Stricker introduced the idea of the memory mountain as a comprehensive characterization of the memory system in [112] and suggested the term "memory mountain" informally in later presentations of the work. Compiler researchers work to increase

locality by automatically performing the kinds of manual code transformations we discussed in [Section 6.6](#) [22, 32, 66, 72, 79, 87, 119]. Carter and colleagues have proposed a cache-aware memory controller [17]. Other researchers have developed *cache-oblivious* algorithms that are designed to run well without any explicit knowledge of the structure of the underlying cache memory [30, 38, 39, 9].

There is a large body of literature on building and using disk storage. Many storage researchers look for ways to aggregate individual disks into larger, more robust, and more secure storage pools [20, 40, 41, 83, 121]. Others look for ways to use caches and locality to improve the performance of disk accesses [12, 21]. Systems such as Exokernel provide increased user-level control of disk and memory resources [57]. Systems such as the Andrew File System [78] and Coda [94] extend the memory hierarchy across computer networks and mobile notebook computers. Schindler and Ganger developed an interesting tool that automatically characterizes the geometry and performance of SCSI disk drives [95]. Researchers have investigated techniques for building and using flash-based SSDs [8, 81].

# Homework Problems

## 6.22

Suppose you are asked to design a rotating disk where the number of bits per track is constant. You know that the number of bits per track is determined by the circumference of the innermost track, which you can assume is also the circumference of the hole. Thus, if you make the hole in the center of the disk larger, the number of bits per track increases, but the total number of tracks decreases. If you let  $r$  denote the radius of the platter, and  $x \cdot r$  the radius of the hole, what value of  $x$  maximizes the capacity of the disk?

## 6.23

Estimate the average time (in ms) to access a sector on the following disk:

## 6.24

Suppose that a 2 MB file consisting of 512-byte logical blocks is stored on a disk drive with the following characteristics:

For each case below, suppose that a program reads the logical blocks of the file sequentially, one after the other, and that the time to position the head over the first block is  $T_{\text{avg seek}} + T_{\text{avg rotation}}$ .

- A. *Best case*: Estimate the optimal time (in ms) required to read the file over all possible mappings of logical blocks to disk sectors.
- B. *Random case*: Estimate the time (in ms) required to read the file if blocks are mapped randomly to disk sectors.

## 6.25

The following table gives the parameters for a number of different caches. For each cache, fill in the missing fields in the table. Recall that  $m$  is the number of physical address bits,  $C$  is the cache size (number of data bytes),  $B$  is the block size in bytes,  $E$  is the associativity,  $S$  is the number of cache sets,  $t$  is the number of tag bits,  $s$  is the number of set index bits, and  $b$  is the number of block offset bits.

## 6.26

The following table gives the parameters for a number of different caches. Your task is to fill in the missing fields in the table. Recall that  $m$  is the number of physical address bits,  $C$  is the cache size (number of data bytes),  $B$  is the block size in bytes,  $E$  is the associativity,  $S$  is the number of cache sets,  $t$  is the number of tag bits,  $s$  is the number of set index bits, and  $b$  is the number of block offset bits.

## 6.27

This problem concerns the cache in [Practice Problem 6.12](#).

- A. List all of the hex memory addresses that will hit in set 1.
- B. List all of the hex memory addresses that will hit in set 6.

## 6.28

This problem concerns the cache in [Practice Problem 6.12](#) .

- A. List all of the hex memory addresses that will hit in set 2.
- B. List all of the hex memory addresses that will hit in set 4.
- C. List all of the hex memory addresses that will hit in set 5.
- D. List all of the hex memory addresses that will hit in set 7.

## 6.29

Suppose we have a system with the following properties:

- The memory is byte addressable.
- Memory accesses are to 1-byte words (not to 4-byte words).
- Addresses are 12 bits wide.
- The cache is two-way set associative ( $E = 2$ ), with a 4-byte block size ( $B = 4$ ) and four sets ( $S = 4$ ).

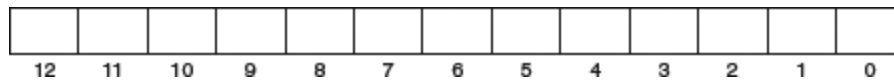
The contents of the cache are as follows, with all addresses, tags, and values given in hexadecimal notation:

A. The following diagram shows the format of an address (1 bit per box). Indicate (by labeling the diagram) the fields that would be used to determine the following:

CO. The cache block offset

CI. The cache set index

CT. The cache tag



B. For each of the following memory accesses, indicate if it will be a cache hit or miss when *carried out in sequence* as listed. Also give the value of a read if it can be inferred from the information in the cache.

## 6.30

Suppose we have a system with the following properties:

- The memory is byte addressable.
- Memory accesses are to 1-byte words (not to 4-byte words).
- Addresses are 13 bits wide.
- The cache is 4-way set associative ( $E = 4$ ), with a 4-byte block size ( $B = 4$ ) and eight sets ( $S = 8$ ).

Consider the following cache state. All addresses, tags, and values are given in hexadecimal format. The Index column contains the set index for each set of four lines. The Tag columns contain the tag value for each line. The V columns contain the valid bit for each line. The Bytes 0–3 columns contain the data for each line, numbered left to right starting with byte 0 on the left.



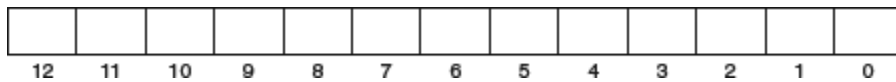
- A. What is the size ( $C$ ) of this cache in bytes?
- B. The box that follows shows the format of an address (1 bit per box). Indicate (by labeling the diagram) the fields that would be used to determine the following:
- CO. The cache block offset
  - CI. The cache set index
  - CT. The cache tag



## 6.31

Suppose that a program using the cache in [Problem 6.30](#) references the 1-byte word at address `0x071A`. Indicate the cache entry accessed and the cache byte value returned *in hex*. Indicate whether a cache miss occurs. If there is a cache miss, enter "—" for "Cache byte returned." *Hint:* Pay attention to those valid bits!

- A. Address format (1 bit per box):

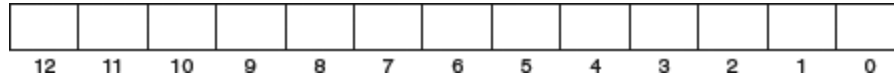


- B. Memory reference:

## 6.32

Repeat [Problem 6.31](#) for memory address `0x16E8`.

A. Address format (1 bit per box):



B. Memory reference:

## 6.33

For the cache in [Problem 6.30](#), list the eight memory addresses (in hex) that will hit in set 2.

## 6.34

Consider the following matrix transpose routine:

```
1     typedef int array[4][4];
2
3     void transpose2(array dst, array src)
4     {
5         int i, j;
6
7         for (i = 0; i < 4; i++) {
8             for (j = 0; j < 4; j++) {
9                 dst[j][i] = src[i][j];
10            }
11        }
12    }
```

Assume this code runs on a machine with the following properties:

- `sizeof(int) = 4`.
- The `src` array starts at address 0 and the `dst` array starts at address 64 (decimal).
- There is a single L1 data cache that is direct-mapped, write-through, write-allocate, with a block size of 16 bytes.

- The cache has a total size of 32 data bytes, and the cache is initially empty.
  - Accesses to the `src` and `dst` arrays are the only sources of read and write misses, respectively.
- A. For each row and `col`, indicate whether the access to `src[row][col]` and `dst[row][col]` is a hit (h) or a miss (m). For example, reading `src[0][0]` is a miss and writing `dst[0][0]` is also a miss.

## 6.35

Repeat [Problem 6.34](#) for a cache with a total size of 128 data bytes.

## 6.36

This problem tests your ability to predict the cache behavior of C code. You are given the following code to analyze:

```
|  
1  int x[2][128];  
2  int i;  
  
3  int sum = 0;  
4  
5  for (i = 0; i < 128; i++) {  
6      sum += x[0][i] * x[1][i];  
7  }
```

Assume we execute this under the following conditions:

- `sizeof(int) = 4`.
- Array `x` begins at memory address `0x0` and is stored in row-major order.
- In each case below, the cache is initially empty.
- The only memory accesses are to the entries of the array `x`. All other variables are stored in registers.

Given these assumptions, estimate the miss rates for the following cases:

- A. Case 1: Assume the cache is 512 bytes, direct-mapped, with 16-byte cache blocks. What is the miss rate?
- B. Case 2: What is the miss rate if we double the cache size to 1,024 bytes?
- C. Case 3: Now assume the cache is 512 bytes, two-way set associative using an LRU replacement policy, with 16-byte cache blocks. What is the cache miss rate?
- D. For case 3, will a larger cache size help to reduce the miss rate? Why or why not?
- E. For case 3, will a larger block size help to reduce the miss rate? Why or why not?

## 6.37

This is another problem that tests your ability to analyze the cache behavior of C code. Assume we execute the three summation functions in [Figure 6.47](#) under the following conditions:

- `sizeof(int) = 4`.
- The machine has a 4 KB direct-mapped cache with a 16-byte block size.
- Within the two loops, the code uses memory accesses only for the array data. The loop indices and the value `sum` are held in registers.
- Array `a` is stored starting at memory address `0x08000000`.

Fill in the table for the approximate cache miss rate for the two cases  $N = 64$  and  $N = 60$ .

```
|
1     typedef int array_t[N][N];
2
3     int sumA(array_t a)
4     {
5         int i, j;
6         int sum = 0;
7         for (i = 0; i < N; i++)
8             for (j = 0; j < N; j++) {
9                 sum += a[i][j];
10            }
11        return sum;
12    }
13
14    int sumB(array_t a)
15    {
16        int i, j;
17        int sum = 0;
18        for (j = 0; j < N; j++)
19            for (i = 0; i < N; i++) {
20                sum += a[i][j];
21            }
22        return sum;
23    }
24
25    int sumC(array_t a)
26    {
27        int i, j;
```



```
28         int sum = 0;
29         for (j = 0; j < N; j+=2)
30             for (i = 0; i < N; i+=2) {
31                 sum += (a[i][j] + a[i+1][j]
32                     + a[i][j+1] + a[i+1]
33 [j+1]);
34             }
35         return sum;
36     }
```

Figure 6.47 Functions referenced in [Problem 6.37](#) .

## 6.38

3M decides to make Post-its by printing yellow squares on white pieces of paper. As part of the printing process, they need to set the CMYK (cyan, magenta, yellow, black) value for every point in the square. 3M hires you to determine the efficiency of the following algorithms on a machine with a 2,048-byte direct-mapped data cache with 32-byte blocks. You are given the following definitions:

```
1 struct point_color {
2     int c;
3     int m;
4     int y;
5     int k;
6 };
7
8 struct point_color square[16][16];
9 int i, j;
```

Assume the following:

- `sizeof(int) = 4`.
- `square` begins at memory address 0.
- The cache is initially empty.

- The only memory accesses are to the entries of the array square. Variables `i` and `j` are stored in registers.

Determine the cache performance of the following code:

```
1     for (i = 0; i < 16; i++){  
2         for (j = 0; j < 16; j++) {  
3             square[i][j].c = 0;  
4             square[i][j].m = 0;  
5             square[i][j].y = 1;  
6             square[i][j].k = 0;  
7         }  
8     }
```

- A. What is the total number of writes?
- B. What is the total number of writes that miss in the cache?
- C. What is the miss rate?

## 6.39

Given the assumptions in [Problem 6.38](#), determine the cache performance of the following code:

```
1   for (i = 0; i < 16; i++){  
2       for (j = 0; j < 16; j++) {  
3           square[j][i].c = 0;  
4           square[j][i].m = 0;  
5           square[j][i].y = 1;  
6           square[j][i].k = 0;  
7       }  
8   }
```

- A. What is the total number of writes?
- B. What is the total number of writes that miss in the cache?
- C. What is the miss rate?

## 6.40

Given the assumptions in [Problem 6.38](#), determine the cache performance of the following code:

```
1   for (i = 0; i < 16; i++) {  
2       for (j = 0; j < 16; j++) {  
3           square[i][j].y = 1;  
4       }  
5   }  
6   for (i = 0; i < 16; i++) {  
7       for (j = 0; j < 16; j++) {  
8           square[i][j].c = 0;  
9           square[i][j].m = 0;  
10          square[i][j].k = 0;  
11      }  
12  }
```

- What is the total number of writes?
- What is the total number of writes that miss in the cache?
- What is the miss rate?

## 6.41

You are writing a new 3D game that you hope will earn you fame and fortune. You are currently working on a function to blank the screen buffer before drawing the next frame. The screen you are working with is a  $640 \times 480$  array of pixels. The machine you are working on has a 64 KB direct-mapped cache with 4-byte lines. The C structures you are using are as follows:

```
1 struct pixel {
2     char r;
3     char g;
4     char b;
5     char a;
6 };
7
8 struct pixel buffer[480][640];
9 int i, j;
10 char *cptr;
11 int *iptr;
```

Assume the following:

- `sizeof(char) = 1` and `sizeof(int) = 4`.
- `buffer` begins at memory address 0.

- The cache is initially empty.
- The only memory accesses are to the entries of the array buffer. Variables `i`, `j`, `cptr`, and `iptr` are stored in registers.

What percentage of writes in the following code will miss in the cache?

```
1     for (j = 0; j < 640; j++) {  
2         for (i = 0; i < 480; i++){  
3             buffer[i][j].r = 0;  
4             buffer[i][j].g = 0;  
5             buffer[i][j].b = 0;  
6             buffer[i][j].a = 0;  
7         }  
8     }
```

## 6.42

Given the assumptions in [Problem 6.41](#), what percentage of writes in the following code will miss in the cache?

```
|  
1 char *cptr = (char *) buffer;  
2 for (; cptr < (((char *) buffer) + 640 * 480 * 4);  
   cptr++)  
3     *cptr = 0;
```

## 6.43

Given the assumptions in [Problem 6.41](#), what percentage of writes in the following code will miss in the cache?

```
|  
1 int *iptr = (int *)buffer;  
2 for (; iptr < ((int *)buffer + 640*480); iptr++)  
3     *iptr = 0;
```



## 6.44

Download the `mountain` program from the CS:APP Web site and run it on your favorite PC/Linux system. Use the results to estimate the sizes of the caches on your system.

## 6.45

In this assignment, you will apply the concepts you learned in [Chapters 5](#) and [6](#) to the problem of optimizing code for a memory-intensive application. Consider a procedure to copy and transpose the elements of an  $N \times N$  matrix of type `int`. That is, for source matrix  $S$  and destination matrix  $D$ , we want to copy each element  $s_{i,j}$  to  $d_{j,i}$ . This code can be written with a simple loop,

```
1 void transpose(int *dst, int *src, int dim)
2 {
3     int i, j;
4
5     for (i = 0; i < dim; i++)
6         for (j = 0; j < dim; j++)
7             dst[j*dim + i] = src[i*dim + j];
8 }
```

where the arguments to the procedure are pointers to the destination (`dst`) and source (`src`) matrices, as well as the matrix size  $N$  (`dim`). Your job is to devise a transpose routine that runs as fast as possible.

## 6.46

This assignment is an intriguing variation of [Problem 6.45](#).

Consider the problem of converting a directed graph  $g$  into its undirected counterpart  $g'$ . The graph  $g'$  has an edge from vertex  $u$  to vertex  $v$  if and only if there is an edge from  $u$  to  $v$  or from  $v$  to  $u$  in the original graph  $g$ . The graph  $g$  is represented by its *adjacency matrix*  $G$  as follows. If  $N$  is the number of vertices in  $g$ , then  $G$  is an  $N \times N$  matrix and its entries are all either 0 or 1. Suppose the vertices of  $g$  are named  $v_0, v_1, v_2, \dots, v_{N-1}$ . Then  $G[i][j]$  is 1 if there is an edge from  $v_i$  to  $v_j$  and is 0 otherwise. Observe that the elements on the diagonal of an adjacency matrix are always 1 and that the adjacency matrix of an undirected graph is symmetric. This code can be written with a simple loop:

```
1 void col_convert(int *G, int dim) {  
2     int i, j;  
3  
4     for (i = 0; i < dim; i++)  
5         for (j = 0; j < dim; j++)  
6             G[j*dim + i] = G[j*dim + i] ||  
G[i*dim + j];  
7 }
```

Your job is to devise a conversion routine that runs as fast as possible. As before, you will need to apply concepts you learned in **Chapters 5** and **6** to come up with a good solution.

[OceanofPDF.com](http://OceanofPDF.com)

# Solutions to Practice Problems

## Solution to Problem 6.1 (page 584)

The idea here is to minimize the number of address bits by minimizing the aspect ratio  $\max(r, c)/\min(r, c)$ . In other words, the squarer the array, the fewer the address bits.

## Solution to Problem 6.2 (page 592)

The point of this little drill is to make sure you understand the relationship between cylinders and tracks. Once you have that straight, just plug and chug:

$$\begin{aligned}\text{Disk capacity} &= \frac{512 \text{ bytes}}{\text{sector}} \times \frac{400 \text{ sectors}}{\text{track}} \times \frac{10,000 \text{ tracks}}{\text{surface}} \times \frac{2 \text{ surfaces}}{\text{platter}} \times \frac{2 \text{ platters}}{\text{disk}} \\ &= 8,192,000,000 \text{ bytes} \\ &= 8.192 \text{ GB}\end{aligned}$$

## Solution to Problem 6.3 □(page 595)

The solution to this problem is a straightforward application of the formula for disk access time. The average rotational latency (in ms) is

$$\begin{aligned}T_{\text{avg rotation}} &= 1/2 \times T_{\text{max rotation}} \\ &= 1/2 \times (60 \text{ secs}/15,000 \text{ RPM}) \times 1,000 \text{ ms/sec} \\ &\approx 2 \text{ ms}\end{aligned}$$

The average transfer time is

$$\begin{aligned}T_{\text{avg transfer}} &= (60 \text{ secs}/15,000 \text{ RPM}) \times 1/500 \text{ sectors/track} \times 1,000 \text{ ms/sec} \\ &\approx 0.008 \text{ ms}\end{aligned}$$

Putting it all together, the total estimated access time is

$$\begin{aligned}T_{\text{access}} &= T_{\text{avg seek}} + T_{\text{avg rotation}} + T_{\text{avg transfer}} \\ &= 8 \text{ ms} + 2 \text{ ms} + 0.008 \text{ ms} \\ &\approx 10 \text{ ms}\end{aligned}$$

## Solution to Problem 6.4 (page 595)

This is a good check of your understanding of the factors that affect disk performance. First we need to determine a few basic properties of the file and the disk. The file consists of 2,000 512-byte logical blocks. For the disk,  $T_{\text{avg seek}} = 5$  ms,  $T_{\text{max rotation}} = 6$  ms, and  $T_{\text{avg rotation}} = 3$  ms.

- A. **Best case:** In the optimal case, the blocks are mapped to contiguous sectors, on the same cylinder, that can be read one after the other without moving the head. Once the head is positioned over the first sector it takes two full rotations (1,000 sectors per rotation) of the disk to read all 2,000 blocks. So the total time to read the file is  $T_{\text{avg seek}} + T_{\text{avg rotation}} + 2 \times T_{\text{max rotation}} = 5 + 3 + 12 = 20$  ms.
- B. **Random case:** In this case, where blocks are mapped randomly to sectors, reading each of the 2,000 blocks requires  $T_{\text{avg seek}} + T_{\text{avg rotation}}$  ms, so the total time to read the file is  $(T_{\text{avg seek}} + T_{\text{avg rotation}}) \times 2,000 = 16,000$  ms (16 seconds!).

You can see now why it's often a good idea to defragment your disk drive!

## Solution to Problem 6.5 □(page 601)

This is a simple problem that will give you some interesting insights into the feasibility of SSDs. Recall that for disks, 1 PB =  $10^9$  MB. Then the following straightforward translation of units yields the following predicted times for each case:

A. Worst-case sequential writes (470 MB/s):

$$(10^9 \times 128) \times (1/470) \times (1/(86,400 \times 365)) \approx 8 \text{ years}$$

B. Worst-case random writes (303 MB/s):

$$(10^9 \times 128) \times (1/303) \times (1/(86,400 \times 365)) \approx 13 \text{ years}$$

C. Average case (20 GB/day):

$$(10^9 \times 128) \times (1/20,000) \times (1/365) \approx 140 \text{ years}$$

So even if the SSD operates continuously, it should last for at least 8 years, which is longer than the expected lifetime of most computers.

## Solution to Problem 6.6 □(page 604)

In the 10-year period between 2005 and 2015, the unit price of rotating disks dropped by a factor of 166, which means the price is dropping by roughly a factor of 2 every 18 months or so. Assuming this trend continues, a petabyte of storage, which costs about \$30,000 in 2015, will drop below \$500 after about seven of these factor-of-2 reductions. Since these are occurring every 18 months, we might expect a petabyte of storage to be available for \$500 around the year 2025.



## Solution to Problem 6.7 (page 608)

To create a stride-1 reference pattern, the loops must be permuted so that the rightmost indices change most rapidly.

```
1 int sumarray3d(int a[N][N][N])
2 {
3     int i, j, k, sum = 0;
4
5     for (k = 0; k < N; k++) {
6         for (i = 0; i < N; i++) {
7             for (j = 0; j < N; j++) {
8                 sum += a[k][i][j];
9             }
10        }
11    }
12    return sum;
13 }
```

This is an important idea. Make sure you understand why this particular loop permutation results in a stride-1 access pattern.

## Solution to Problem 6.8 [□](#)(page 609)

The key to solving this problem is to visualize how the array is laid out in memory and then analyze the reference patterns. Function `clear1` accesses the array using a stride-1 reference pattern and thus clearly has the best spatial locality. Function `clear2` scans each of the  $N$  structs in order, which is good, but within each struct it hops around in a non-stride-1 pattern at the following offsets from the beginning of the struct: 0, 12, 4, 16, 8, 20. So `clear2` has worse spatial locality than `clear1`. Function `clear3` not only hops around within each struct, but also hops from struct to struct. So `clear3` exhibits worse spatial locality than `clear2` and `clear1`.

## Solution to Problem 6.9 [□](#)(page 616)

The solution is a straightforward application of the definitions of the various cache parameters in [Figure 6.26 \[□\]\(#\)](#). Not very exciting, but you need to understand how the cache organization induces these partitions in the address bits before you can really understand how caches work.

## Solution to Problem 6.10 [□](#)(page 624)

The padding eliminates the conflict misses. Thus, three-fourths of the references are hits.

## Solution to Problem 6.11 □(page 624)

Sometimes, understanding why something is a bad idea helps you understand why the alternative is a good idea. Here, the bad idea we are looking at is indexing the cache with the high-order bits instead of the middle bits.

- A. With high-order bit indexing, each contiguous array chunk consists of  $2^t$  blocks, where  $t$  is the number of tag bits. Thus, the first  $2^t$  contiguous blocks of the array would map to set 0, the next  $2^t$  blocks would map to set 1, and so on.
- B. For a direct-mapped cache where  $(S, E, B, m) = (512, 1, 32, 32)$ , the cache capacity is 512 32-byte blocks with  $t = 18$  tag bits in each cache line. Thus, the first  $2^{18}$  blocks in the array would map to set 0, the next  $2^{18}$  blocks to set 1. Since our array consists of only  $(4,096 \times 4)/32 = 512$  blocks, all of the blocks in the array map to set 0. Thus, the cache will hold at most 1 array block at any point in time, even though the array is small enough to fit entirely in the cache. Clearly, using high-order bit indexing makes poor use of the cache.

## Solution to Problem 6.12 □(page 628)

The 2 low-order bits are the block offset (CO), followed by 3 bits of set index (CI), with the remaining bits serving as the tag (CT):

CT	CT	CT	CT	CT	CT	CT	CT	CI	CI	CI	CO	CO
12	11	10	9	8	7	6	5	4	3	2	1	0

## Solution to Problem 6.13 □(page 628)

Address: 0x0E34

A. Address format (1 bit per box):

CT	CT	CT	CT	CT	CT	CT	CT	CI	CI	CI	CO	CO
0	1	1	1	0	0	0	1	1	0	1	0	0
12	11	10	9	8	7	6	5	4	3	2	1	0

B. Memory reference:

## Solution to Problem 6.14 □(page 629)

Address: 0x0DD5

A. Address format (1 bit per box):

CT	CT	CT	CT	CT	CT	CT	CT	CI	CI	CI	CO	CO
0	1	1	0	1	1	1	0	1	0	1	0	1
12	11	10	9	8	7	6	5	4	3	2	1	0

B. Memory reference:

## Solution to Problem 6.15 □(page 629)

Address: 0x1FE4

A. Address format (1 bit per box):

CT	CT	CT	CT	CT	CT	CT	CT	CI	CI	CI	CO	CO
1	1	1	1	1	1	1	1	0	0	1	0	0
12	11	10	9	8	7	6	5	4	3	2	1	0

B. Memory reference:

## Solution to Problem 6.16 (page 630)

This problem is a sort of inverse version of Practice Problems 6.12–6.15 that requires you to work backward from the contents of the cache to derive the addresses that will hit in a particular set. In this case, set 3 contains one valid line with a tag of `0x32`.

Since there is only one valid line in the set, four addresses will hit. These addresses have the binary form `0 0110 0100 11xx`. Thus, the four hex addresses that hit in set 3 are

```
0x064C, 0x064D, 0x064E, and 0x064F
```

## Solution to Problem 6.17 (page 636)

- A. The key to solving this problem is to visualize the picture in [Figure 6.48](#). Notice that each cache line holds exactly one row of the array, that the cache is exactly large enough to hold one array, and that for all  $i$ , row  $i$  of `src` and `dst` maps to the same cache line. Because the cache is too small to hold both arrays, references to one array keep evicting useful lines from the other array. For example, the write to `dst[0][0]` evicts the line that was loaded when we read `src[0][0]`. So when we next read `src[0][1]`, we have a miss.
- B. When the cache is 32 bytes, it is large enough to hold both arrays. Thus, the only misses are the initial cold misses.

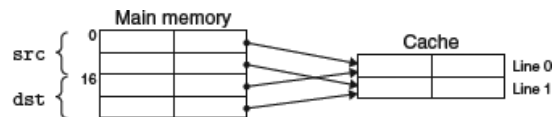


Figure 6.48 Figure for solution to [Problem 6.17](#).

## Solution to Problem 6.18 □(page 637)

Each 16-byte cache line holds two contiguous `algae_position` structures. Each loop visits these structures in memory order, reading one integer element each time. So the pattern for each loop is miss, hit, miss, hit, and so on. Notice that for this problem we could have predicted the miss rate without actually enumerating the total number of reads and misses.

- A. What is the total number of read accesses? 512 reads.
- B. What is the total number of read accesses that miss in the cache? 256 misses.
- C. What is the miss rate?  $256/512 = 50\%$ .

## Solution to Problem 6.19 □(page 638)

The key to this problem is noticing that the cache can only hold 1/2 of the array. So the column-wise scan of the second half of the array evicts the lines that were loaded during the scan of the first half. For example, reading the first element of `grid[8][0]` evicts the line that was loaded when we read elements from `grid[0][0]`. This line also contained `grid[0][1]`. So when we begin scanning the next column, the reference to the first element of `grid[0][1]` misses.

- A. What is the total number of read accesses? 512 reads.
- B. What is the total number of read accesses that miss in the cache? 256 misses.
- C. What is the miss rate?  $256/512 = 50\%$ .
- D. What would the miss rate be if the cache were twice as big? If the cache were twice as big, it could hold the entire grid array. The only misses would be the initial cold misses, and the miss rate would be  $1/4 = 25\%$ .

## Solution to Problem 6.20 □(page 638)

This loop has a nice stride-1 reference pattern, and thus the only misses are the initial cold misses.

- A. What is the total number of read accesses? 512 reads.
- B. What is the total number of read accesses that miss in the cache? 128 misses.
- C. What is the miss rate?  $128/512 = 25\%$ .
- D. What would the miss rate be if the cache were twice as big? Increasing the cache size by any amount would not change the miss rate, since cold misses are unavoidable.

## Solution to Problem 6.21 □(page 643)

The sustained throughput using large strides from L1 is about 12,000 MB/s, the clock frequency is 2,100 MHz, and the individual read accesses are in units of 8-byte longs. Thus, from this graph we can estimate that it takes roughly  $2,100/12,000 \times 8 = 1.4 \approx 1.5$  cycles to access a word from L1 on this machine, which is roughly 2.5 times faster than the nominal 4-cycle latency from L1. This is due to the parallelism of the  $4 \times 4$  unrolled loop, which allows multiple loads to be in flight at the same time.

# Part II Running Programs on a System

Our exploration of computer systems continues with a closer look at the systems software that builds and runs application programs. The linker combines different parts of our programs into a single file that can be loaded into memory and executed by the processor. Modern operating systems cooperate with the hardware to provide each program with the illusion that it has exclusive use of a processor and the main memory, when in reality multiple programs are running on the system at any point in time.

In the first part of this book, you developed a good understanding of the interaction between your programs and the hardware. Part II of the book will broaden your view of systems by giving you a solid understanding of the interactions between your programs and the operating system. You will learn how to use services provided by the operating system to build system-level programs such as Unix shells and dynamic memory allocation packages.





# Chapter 7 Linking



**7.1 Compiler Drivers 671** [📄](#)

**7.2 Static Linking 672** [📄](#)

**7.3 Object Files 673** [📄](#)

**7.4 Relocatable Object Files 674** [📄](#)

**7.5 Symbols and Symbol Tables 675** [📄](#)

**7.6 Symbol Resolution 679** [📄](#)

**7.7 Relocation 689** [📄](#)

**7.8 Executable Object Files 695** [📄](#)

**7.9 Loading Executable Object Files 697** [📄](#)

**7.10 Dynamic Linking with Shared Libraries 698** [📄](#)

**7.11 Loading and Linking Shared Libraries from Applications  
701** [📄](#)

**7.12 Position-Independent Code (PIC) 704** [📄](#)

**7.13 Library Interpositioning 707** [📄](#)

**7.14 Tools for Manipulating Object Files 713** [📄](#)

**7.15 Summary 713** [📄](#)

**Bibliographic Notes 714** [📄](#)

**Homework Problems 714** [📄](#)

**Solutions to Practice Problems 717** [📄](#)

*Linking is the process of collecting and combining various pieces of code and data into a single file that can be loaded (copied) into memory and executed. Linking can be performed at compile time, when the source code is translated into machine code; at load time, when the program is loaded into memory and executed by the loader; and even at run time, by application programs. On early computer systems, linking was performed manually. On modern systems, linking is performed automatically by programs called linkers.*

*Linkers play a crucial role in software development because they enable separate compilation. Instead of organizing a large application as one monolithic source file, we can decompose it into smaller, more manageable modules that can be modified and compiled separately. When we change one of these modules, we simply recompile it and relink the application, without having to recompile the other files.*

*Linking is usually handled quietly by the linker and is not an important issue for students who*

*are building small programs in introductory programming classes. So why bother learning about linking?*

- ***Understanding linkers will help you build large programs.*** *Programmers who build large programs often encounter linker errors caused by missing modules, missing libraries, or incompatible library versions. Unless you understand how a linker resolves references, what a library is, and how a linker uses a library to resolve references, these kinds of errors will be baffling and frustrating.*
- ***Understanding linkers will help you avoid dangerous programming errors.*** *The decisions that Linux linkers make when they resolve symbol references can silently affect the correctness of your programs. Programs that incorrectly define multiple global variables can pass through the linker without any warnings in the default case. The resulting programs can exhibit baffling runtime behavior and are extremely difficult to debug. We will show you how this happens and how to avoid it.*
- ***Understanding linking will help you understand how language scoping rules***

**are implemented.** For example, what is the difference between global and local variables? What does it really mean when you define a variable or function with the static attribute?

- **Understanding linking will help you understand other important systems concepts.** The executable object files produced by linkers play key roles in important systems functions such as loading and running programs, virtual memory, paging, and memory mapping.
- **Understanding linking will enable you to exploit shared libraries.** For many years, linking was considered to be fairly straightforward and uninteresting. However, with the increased importance of shared libraries and dynamic linking in modern operating systems, linking is a sophisticated process that provides the knowledgeable programmer with significant power. For example, many software products use shared libraries to upgrade shrink-wrapped binaries at run time. Also, many Web servers rely on dynamic linking of shared libraries to serve dynamic content.

(a) `main.c`

-----[code/link/main.c](#)

```
|  
1  int sum(int *a, int n);  
2  
3  int array[2] = {1, 2};  
4  
5  int main()  
6  {  
7      int val = sum(array, 2);  
8      return val;  
9  }
```

-----[code/link/main.c](#)

(b) `sum.c`

-----[code/link/sum.c](#)

```
|  
1     int sum(int *a, int n)  
2     {  
3         int i, s = 0;  
4  
5         for (i = 0; i < n; i++) {  
6             s += a[i];  
7         }  
8         return s;  
9     }
```

-----code/link/sum.c

### **Figure 7.1 Example program 1.**

The example program consists of two source files, `main.c` and `sum.c`. The `main` function initializes an array of `ints`, and then calls the `sum` function to sum the array elements.

This chapter provides a thorough discussion of all aspects of linking, from traditional static linking, to dynamic linking of shared libraries at load time, to dynamic linking of shared libraries at run time. We will describe the basic

*mechanisms using real examples, and we will identify situations in which linking issues can affect the performance and correctness of your programs. To keep things concrete and understandable, we will couch our discussion in the context of an x86-64 system running Linux and using the standard ELF-64 (hereafter referred to as ELF) object file format. However, it is important to realize that the basic concepts of linking are universal, regardless of the operating system, the ISA, or the object file format. Details may vary, but the concepts are the same.*

[OceanofPDF.com](http://OceanofPDF.com)



## 7.1 Compiler Drivers

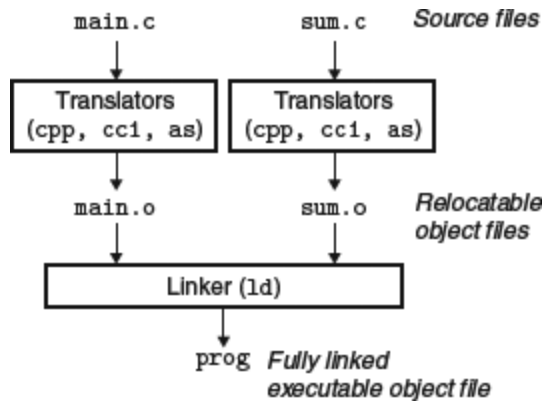
Consider the C program in [Figure 7.1](#). It will serve as a simple running example throughout this chapter that will allow us to make some important points about how linkers work.

Most compilation systems provide a *compiler driver* that invokes the language preprocessor, compiler, assembler, and linker, as needed on behalf of the user. For example, to build the example program using the GNU compilation system, we might invoke the `gcc` driver by typing the following command to the shell:

```
linux> gcc -Og -o prog main.c sum.c
```

[Figure 7.2](#) summarizes the activities of the driver as it translates the example program from an ASCII source file into an executable object file. (If you want to see these steps for yourself, run `gcc` with the `-v` option.) The driver first runs the C preprocessor (`cpp`),<sup>1</sup> which translates the C source file `main.c` into an ASCII intermediate file `main.i`:

<sup>1</sup> In some versions of `gcc`, the preprocessor is integrated into the compiler driver.



**Figure 7.2 Static linking.**

The linker combines relocatable object files to form an executable object file `prog`.

```
cpp [other arguments] main.c /tmp/main.i
```

Next, the driver runs the C compiler (`cc1`), which translates `main.i` into an ASCII assembly-language file `main.s`:

```
cc1 /tmp/main.i -Og [other arguments] -o /tmp/main.s
```

Then, the driver runs the assembler (`as`), which translates `main.s` into a binary *relocatable object file* `main.o`:

```
as [other arguments] -o /tmp/main.o /tmp/main.s
```

The driver goes through the same process to generate `sum.o`. Finally, it runs the linker program `ld`, which combines `main.o` and `sum.o`, along with the necessary system object files, to create the binary *executable object file* `prog`:

```
ld -o prog [system object files and args] /tmp/main.o /tmp/sum.o
```

To run the executable `prog`, we type its name on the Linux shell's command line:

```
linux> ./prog
```

The shell invokes a function in the operating system called the *loader*, which copies the code and data in the executable file `prog` into memory, and then transfers control to the beginning of the program.

## 7.2 Static Linking

*Static linkers* such as the Linux LD program take as input a collection of relocatable object files and command-line arguments and generate as output a fully linked executable object file that can be loaded and run. The input relocatable object files consist of various code and data sections, where each section is a contiguous sequence of bytes. Instructions are in one section, initialized global variables are in another section, and uninitialized variables are in yet another section.

To build the executable, the linker must perform two main tasks:

Step 1. **Symbol resolution.** Object files define and reference *symbols*, where each symbol corresponds to a function, a global variable, or a *static variable* (i.e., any C variable declared with the `static` attribute). The purpose of symbol resolution is to associate each symbol *reference* with exactly one symbol *definition*.

Step 2. **Relocation.** Compilers and assemblers generate code and data sections that start at address 0. The linker *relocates* these sections by associating a memory location with each symbol definition, and then modifying all of the references to those symbols so that they point to this memory location. The linker blindly performs these relocations using

detailed instructions, generated by the assembler, called *relocation entries*.

The sections that follow describe these tasks in more detail. As you read, keep in mind some basic facts about linkers: Object files are merely collections of blocks of bytes. Some of these blocks contain program code, others contain program data, and others contain data structures that guide the linker and loader. A linker concatenates blocks together, decides on run-time locations for the concatenated blocks, and modifies various locations within the code and data blocks. Linkers have minimal understanding of the target machine. The compilers and assemblers that generate the object files have already done most of the work.

[OceanofPDF.com](http://OceanofPDF.com)

## 7.3 Object Files

Object files come in three forms:

**Relocatable object file.** Contains binary code and data in a form that can be combined with other relocatable object files at compile time to create an executable object file.

**Executable object file.** Contains binary code and data in a form that can be copied directly into memory and executed.

**Shared object file.** A special type of relocatable object file that can be loaded into memory and linked dynamically, at either load time or run time.

Compilers and assemblers generate relocatable object files (including shared object files). Linkers generate executable object files. Technically, an *object module* is a sequence of bytes, and an *object file* is an object module stored on disk in a file. However, we will use these terms interchangeably.

Object files are organized according to specific *object file formats*, which vary from system to system. The first Unix systems from Bell Labs used the `a.out` format. (To this day, executables are still referred to as `a.out` files.) Windows uses the Portable Executable (PE) format. Mac OS-X uses the Mach-O format. Modern x86-64 Linux and Unix systems use *Executable and Linkable Format (ELF)*.

Although our discussion will focus on ELF, the basic concepts are similar, regardless of the particular format.

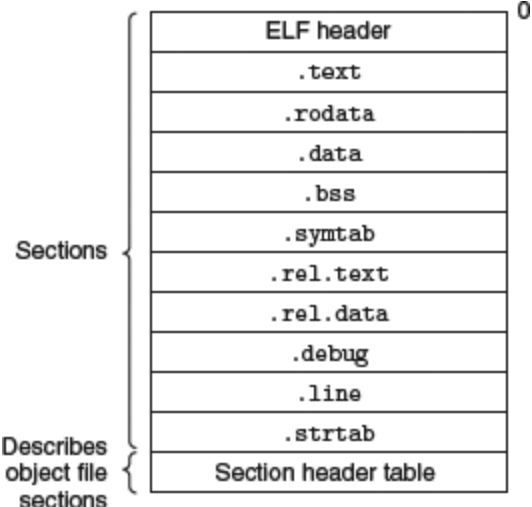



Figure 7.3 Typical ELF relocatable object file.

## 7.4 Relocatable Object Files

**Figure 7.3**  shows the format of a typical ELF relocatable object file. The *ELF header* begins with a 16-byte sequence that describes the word size and byte ordering of the system that generated the file. The rest of the ELF header contains information that allows a linker to parse and interpret the object file. This includes the size of the ELF header, the object file type (e.g., relocatable, executable, or shared), the machine type (e.g., x86-64), the file offset of the section header table, and the size and number of entries in the section header table. The locations and sizes of the various sections are described by the *section header table*, which contains a fixed-size entry for each section in the object file.

Sandwiched between the ELF header and the section header table are the sections themselves. A typical ELF relocatable object file contains the following sections:

`.text` The machine code of the compiled program.

`.rodata` Read-only data such as the format strings in `printf` statements, and jump tables for switch statements.

`.data` *Initialized* global and static C variables. Local C variables are maintained at run time on the stack and do *not* appear in either the `.data` or `.bss` sections.



`.bss` *Uninitialized* global and static C variables, along with any global or static variables that are initialized to zero. This section occupies no actual space in the object file; it is merely a placeholder. Object file formats distinguish between initialized and uninitialized variables for space efficiency: uninitialized variables do not have to occupy any actual disk space in the object file. At run time, these variables are allocated in memory with an initial value of zero.

## Aside Why is uninitialized data called `.bss`?

The use of the term `.bss` to denote uninitialized data is universal. It was originally an acronym for the "block started by symbol" directive from the IBM 704 assembly language (circa 1957) and the acronym has stuck. A simple way to remember the difference between the `.data` and `.bss` sections is to think of "bss" as an abbreviation for "Better Save Space!"

`.symtab` A *symbol table* with information about functions and global variables that are defined and referenced in the program. Some programmers mistakenly believe that a program must be compiled with the `-g` option to get symbol table information. In fact, every relocatable object file has a symbol table in `.symtab` (unless the programmer has specifically removed it with the `STRIP` command). However, unlike the symbol table inside a compiler,

the `.symtab` symbol table does not contain entries for local variables.

`.rel.text` A list of locations in the `.text` section that will need to be modified when the linker combines this object file with others. In general, any instruction that calls an external function or references a global variable will need to be modified. On the other hand, instructions that call local functions do not need to be modified. Note that relocation information is not needed in executable object files, and is usually omitted unless the user explicitly instructs the linker to include it.

`.rel.data` Relocation information for any global variables that are referenced or defined by the module. In general, any initialized global variable whose initial value is the address of a global variable or externally defined function will need to be modified.

`.debug` A debugging symbol table with entries for local variables and typedefs defined in the program, global variables defined and referenced in the program, and the original C source file. It is only present if the compiler driver is invoked with the `-g` option.

`.line` A mapping between line numbers in the original C source program and machine code instructions in the `.text` section. It is only present if the compiler driver is invoked with the `-g` option.

`.strtab` A string table for the symbol tables in the `.symtab` and `.debug` sections and for the section names in the section

headers. A string table is a sequence of null-terminated character strings.

[OceanofPDF.com](http://OceanofPDF.com)

## 7.5 Symbols and Symbol Tables

Each relocatable object module,  $m$ , has a symbol table that contains information about the symbols that are defined and referenced by  $m$ . In the context of a linker, there are three different kinds of symbols:

- *Global symbols* that are defined by module  $m$  and that can be referenced by other modules. Global linker symbols correspond to *nonstatic* C functions and global variables.
- Global symbols that are referenced by module  $m$  but defined by some other module. Such symbols are called *externals* and correspond to nonstatic C functions and global variables that are defined in other modules.
- *Local symbols* that are defined and referenced exclusively by module  $m$ . These correspond to static C functions and global variables that are defined with the static attribute. These symbols are visible anywhere within module  $m$ , but cannot be referenced by other modules.


It is important to realize that local linker symbols are not the same as local program variables. The symbol table in `.symtab` does not contain any symbols that correspond to local nonstatic program variables. These are managed at run time on the stack and are not of interest to the linker.

Interestingly, local procedure variables that are defined with the C `static` attribute are not managed on the stack. Instead, the compiler allocates space in `.data` or `.bss` for each definition and creates a local linker symbol in the symbol table with a unique name. For example, suppose a pair of functions in the same module define a static local variable `x`:

```
|
1  int f()
2  {
3      static int x = 0;
4      return x;
5  }
6
7  int g()
8  {
9      static int x = 1;
10     return x;
11 }
```

In this case, the compiler exports a pair of local linker symbols with different names to the assembler. For example, it might use `x.1` for the definition in function `f` and `x.2` for the definition in function `g`.

Symbol tables are built by assemblers, using symbols exported by the compiler into the assembly-language `.s` file. An ELF symbol

table is contained in the `.symtab` section. It contains an array of entries. **Figure 7.4**  shows the format of each entry.

The `name` is a byte offset into the string table that points to the null-terminated string name of the symbol. The `value` is the symbol's address. For relocatable modules, the `value` is an offset from the beginning of the section where the object is defined. For executable object files, the `value` is an absolute run-time address. The `size` is the size (in bytes) of the object. The `type` is usually either `data` or `function`. The symbol table can also contain entries for the individual sections

## New to C? Hiding variable and function names with `static`

C programmers use the `static` attribute to hide variable and function declarations inside modules, much as you would use *public* and *private* declarations in Java and C++. In C, source files play the role of modules. Any global variable or function declared with the `static` attribute is private to that module. Similarly, any global variable or function declared without the `static` attribute is public and can be accessed by any other module. It is good programming practice to protect your variables and functions with the `static` attribute wherever possible.

-----code/link/elfstructs.c

```
1     typedef struct {
2         int     name;           /* String table offset */
3         char    type:4,         /* Function or data (4 bits) */
4         binding:4;             /* Local or global (4 bits) */
5         char    reserved;      /* Unused */
6         short   section;        /* Section header index */
7         long    value;          /* Section offset or absolute
address */
8         long    size;           /* Object size in bytes */
9     } Elf64_Symbol;
```

-----code/link/elfstructs.c

### Figure 7.4 ELF symbol table entry.

The type and binding fields are 4 bits each.

and for the path name of the original source file. So there are distinct types for these objects as well. The binding field indicates whether the symbol is local or global.

Each symbol is assigned to some section of the object file, denoted by the section field, which is an index into the section header table. There are three special pseudosections that don't have entries in the section header table: ABS is for symbols that should not be

relocated. UNDEF is for undefined symbols—that is, symbols that are referenced in this object module but defined elsewhere. COMMON is for uninitialized data objects that are not yet allocated. For COMMON symbols, the `value` field gives the alignment requirement, and `size` gives the minimum size. Note that these pseudosections exist only in relocatable object files; they do not exist in executable object files.

The distinction between COMMON and `.bss` is subtle. Modern versions of `gcc` assign symbols in relocatable object files to COMMON and `.bss` using the following convention:

The reason for this seemingly arbitrary distinction stems from the way the linker performs symbol resolution, which we will explain in [Section 7.6](#).

The GNU `readelf` program is a handy tool for viewing the contents of object files. For example, here are the last three symbol table entries for the relocatable object `file main.o`, from the example program in [Figure 7.1](#). The first eight entries, which are not shown, are local symbols that the linker uses internally.



In this example, we see an entry for the definition of global symbol `main`, a 24-byte function located at an offset (i.e., `value`) of zero in the `.text` section. This is followed by the definition of the global symbol `array`, an 8-byte object located at an offset of zero in the `.data` section. The last entry comes from the reference to the external symbol `SUM`. `READELF` identifies each section by an integer index. `Ndx=1` denotes the `.text` section, and `Ndx=3` denotes the `.data` section.

# Practice Problem 7.1 (solution page 717)

This problem concerns the `m.o` and `swap.o` modules from [Figure 7.5](#). For each symbol that is defined or referenced in `swap.o`, indicate whether or not it will have a symbol table entry in the `.symtab` section in module `swap.o`. If so, indicate the module that defines the symbol (`swap.o` or `m.o`), the symbol type (local, global, or extern), and the section (`.text`, `.data`, `.bss`, or COMMON) it is assigned to in the module.

(a) m.c

-----code/link/m.c

```
|  
1 void swap();  
2  
3 int buf[2] = {1, 2};  
4  
5 int main()  
6 {  
7     swap();  
8     return 0;  
9 }
```

-----code/link/m.c

(b) swap.c

-----code/link/swap.c

```
|  
1     extern int buf[];  
2  
3     int *bufp0 = &buf[0];  
4     int *bufp1;  
5  
6     void swap()  
7     {  
8         int temp;  
9  
10        bufp1 = &buf[1];  
11        temp = *bufp0;  
12        *bufp0 = *bufp1;  
13        *bufp1 = temp;  
14    }
```

-----[code/link/swap.c](#)

**Figure 7.5** Example program for [Practice Problem 7.1](#) .

[OceanofPDF.com](http://OceanofPDF.com)

## 7.6 Symbol Resolution

The linker resolves symbol references by associating each reference with exactly one symbol definition from the symbol tables of its input relocatable object files. Symbol resolution is straightforward for references to local symbols that are defined in the same module as the reference. The compiler allows only one definition of each local symbol per module. The compiler also ensures that static local variables, which get local linker symbols, have unique names.

Resolving references to global symbols, however, is trickier. When the compiler encounters a symbol (either a variable or function name) that is not defined in the current module, it assumes that it is defined in some other module, generates a linker symbol table entry, and leaves it for the linker to handle. If the linker is unable to find a definition for the referenced symbol in any of its input modules, it prints an (often cryptic) error message and terminates. For example, if we try to compile and link the following source file on a Linux machine,

```
|  
1 void foo(void);  
2  
3 int main() {  
4     foo();  
5     return 0;  
6 }
```

then the compiler runs without a hitch, but the linker terminates when it cannot resolve the reference to `foo:`

```
linux> gcc -Wall -Og -o linkerror linkerror.c  
/tmp/ccSz5uti.o: In function `main':  
/tmp/ccSz5uti.o(.text+0x7): undefined reference to `foo'
```

Symbol resolution for global symbols is also tricky because multiple object modules might define global symbols with the same name. In this case, the linker must either flag an error or somehow choose one of the definitions and discard the rest. The approach adopted by Linux systems involves cooperation between the compiler, assembler, and linker and can introduce some baffling bugs to the unwary programmer.

# Aside Mangling of linker symbols in C++ and Java

Both C++ and Java allow overloaded methods that have the same name in the source code but different parameter lists. So how does the linker tell the difference between these different overloaded functions? Overloaded functions in C++ and Java work because the compiler encodes each unique method and parameter list combination into a unique name for the linker. This encoding process is called *mangling*, and the inverse process is known as *demangling*.

Happily, C++ and Java use compatible mangling schemes. A mangled class name consists of the integer number of characters in the name followed by the original name. For example, the class `Foo` is encoded as `3Foo`. A method is encoded as the original method name, followed by `__`, followed by the mangled class name, followed by single letter encodings of each argument. For example, `Foo::bar(int, long)` is encoded as `bar_3Fooil`. Similar schemes are used to mangle global variable and template names.



## 7.6.1 How Linkers Resolve Duplicate Symbol Names

The input to the linker is a collection of relocatable object modules. Each of these modules defines a set of symbols, some of which are local (visible only to the module that defines it), and some of which are global (visible to other modules). What happens if multiple modules define global symbols with the same name? Here is the approach that Linux compilation systems use.

At compile time, the compiler exports each global symbol to the assembler as either *strong* or *weak*, and the assembler encodes this information implicitly in the symbol table of the relocatable object file. Functions and initialized global variables get strong symbols. Uninitialized global variables get weak symbols.

Given this notion of strong and weak symbols, Linux linkers use the following rules for dealing with duplicate symbol names:

Rule 1. Multiple strong symbols with the same name are not allowed.

Rule 2. Given a strong symbol and multiple weak symbols with the same name, choose the strong symbol.

Rule 3. Given multiple weak symbols with the same name, choose any of the weak symbols.

For example, suppose we attempt to compile and link the following two C modules:

```
|
1  /* foo1.c */
2  int main()
3  {
4      return 0;
5  }
1  /* bar1.c */
2  int main()
3  {
4      return 0;
5  }
```

In this case, the linker will generate an error message because the strong symbol `main` is defined multiple times (rule 1):

```
linux> gcc foo1.c bar1.c
/tmp/ccq2Uxnd.o: In function `main':
bar1.c:(.text+0x0): multiple definition of `main'
```

Similarly, the linker will generate an error message for the following modules because the strong symbol `x` is defined twice (rule 1):

```
|
1  /* foo2.c */
2  int x = 15213;
3
4  int main()
5  {
6      return 0;
7  }
```

```
|
1  /* bar2.c */
2  int x = 15213;
3
4  void f()
5  {
6  }
```

However, if `x` is uninitialized in one module, then the linker will quietly choose the strong symbol defined in the other (rule 2):

```

1      /* foo3.c */
2      #include <stdio.h>
3      void f(void);
4
5      int x = 15213;
6
7      int main()
8      {
9          f();
10         printf("x = %dn", x);
11         return 0;
12     }

```

```

1      /* bar3.c */
2      int x;
3
4      void f()
5      {
6          x = 15212;
7      }

```

At run time, function `f` changes the value of `x` from 15213 to 15212, which might come as an unwelcome surprise to the author of

function `main`! Notice that the linker normally gives no indication that it has detected multiple definitions of `x`:

```
linux> gcc -o foobar3 foo3.c bar3.c
linux> ./foobar3
x = 15212
```

The same thing can happen if there are two weak definitions of `x` (rule 3):

```
1      /* foo4.c */
2      #include <stdio.h>
3      void f(void);
4
5      int x;
6
7      int main()
8      {
9          x = 15213;
10         f();
11         printf("x = %dn", x);
12         return 0;
13     }
```

```
|  
1      /* bar4.c */  
2      int x;  
3  
4      void f()  
5      {  
6          x = 15212;  
7      }
```

The application of rules 2 and 3 can introduce some insidious run-time bugs that are incomprehensible to the unwary programmer, especially if the duplicate symbol definitions have different types. Consider the following example, in which `x` is inadvertently defined as an `int` in one module and a double in another:

```
|
1      /* foo5.c */
2      #include <stdio.h>
3      void f(void);
4
5      int y = 15212;
6      int x = 15213;
7
8      int main()
9      {
10         f();
11         printf("x = 0x%x y = 0x%x n",
12             x, y);
13         return 0;
14     }
```

```
|
1      /* bar5.c */
2      double x;
3
4      void f()
5      {
6         x = -0.0;
7     }
```

On an x86-64/Linux machine, `doubles` are 8 bytes and `ints` are 4 bytes. On our system, the address of `x` is `0x601020` and the address of `y` is `0x601024`. Thus, the assignment `x = -0.0` in line 6 of `bar5.c` will overwrite the memory locations for `x` and `y` (lines 5 and 6 in `foo5.c`) with the double-precision floating-point representation of negative zero!

```
linux> gcc -Wall -Og -o foobar5 foo5.c bar5.c
/usr/bin/ld: Warning: alignment 4 of symbol `x' in
/tmp/cc1UfK5g.o
is smaller than 8 in /tmp/ccbTLcb9.o
linux> ./foobar5
x = 0x0 y = 0x80000000
```

This is a subtle and nasty bug, especially because it triggers only a warning from the linker, and because it typically manifests itself much later in the execution of the program, far away from where the error occurred. In a large system with hundreds of modules, a bug of this kind is extremely hard to fix, especially because many programmers are not aware of how linkers work, and because they often ignore compiler warnings. When in doubt, invoke the linker with a flag such as the GCC `-fno-common` flag, which triggers an error if it encounters multiply-defined global symbols. Or use the `-Werror` option, which turns all warnings into errors.



In [Section 7.5](#), we saw how the compiler assigns symbols to COMMON and `.bss` using a seemingly arbitrary convention. Actually, this convention is due to the fact that in some cases the linker allows multiple modules to define global symbols with the same name. When the compiler is translating some module and encounters a weak global symbol, say, `x`, it does not know if other modules also define `x`, and if so, it cannot predict which of the multiple instances of `x` the linker might choose. So the compiler defers the decision to the linker by assigning `x` to COMMON. On the other hand, if `x` is initialized to zero, then it is a strong symbol (and thus must be unique by rule 2), so the compiler can confidently assign it to `.bss`. Similarly, static symbols are unique by construction, so the compiler can confidently assign them to either `.data` or `.bss`.

## Practice Problem 7.2 (solution page 718)

In this problem, let  $\text{REF}(x.i) \rightarrow \text{DEF}(x.k)$  denote that the linker will associate an arbitrary reference to symbol  $x$  in module  $i$  to the definition of  $x$  in module  $k$ . For each example that follows, use this notation to indicate how the linker would resolve references to the multiply-defined symbol in each module. If there is a link-time error (rule 1), write "ERROR". If the linker arbitrarily chooses one of the definitions (rule 3), write "UNKNOWN".

A.

```
/* Module 1 */      /* Module 2 */
int main()          int main;
{                  int p2()
}                  {
                  }
                  }
```

(a)  $\text{REF}(\text{main}.1) \rightarrow \text{DEF}(\text{_____}. \text{_____})$   
(b)  $\text{REF}(\text{main}.2) \rightarrow \text{DEF}(\text{_____}. \text{_____})$

B.

```
/* Module 1 */      /* Module 2 */
void main()         int main = 1;
{                  int p2()
}                  {
                  }
                  }
```

(a)  $\text{REF}(\text{main}.1) \rightarrow \text{DEF}(\text{_____}. \text{_____})$   
(b)  $\text{REF}(\text{main}.2) \rightarrow \text{DEF}(\text{_____}. \text{_____})$

C.

```
/* Module 1 */          /* Module 2 */  
intx;                   doublex=1.0;  
void main()             int p2()  
{                       {  
}                       }  
(a) REF(x.1) → DEF(____.____)  
(b) REF(x.2) → DEF(____.____)
```

## 7.6.2 Linking with Static Libraries

So far, we have assumed that the linker reads a collection of relocatable object files and links them together into an output executable file. In practice, all compilation systems provide a mechanism for packaging related object modules into a single file called a *static library*, which can then be supplied as input to the linker. When it builds the output executable, the linker copies only the object modules in the library that are referenced by the application program.

Why do systems support the notion of libraries? Consider ISO C99, which defines an extensive collection of standard I/O, string manipulation, and integer math functions such as `atoi`, `printf`, `scanf`, `strcpy`, and `rand`. They are available to every C program in the `libc.a` library. ISO C99 also defines an extensive collection of floating-point math functions such as `sin`, `cos`, and `sqrt` in the `libm.a` library.

Consider the different approaches that compiler developers might use to provide these functions to users without the benefit of static libraries. One approach would be to have the compiler recognize calls to the standard functions and to generate the appropriate code directly. Pascal, which provides a small set of standard functions, takes this approach, but it is not feasible for C, because of the large number of standard functions defined by the C standard. It would add significant complexity to the compiler and would require a new

compiler version each time a function was added, deleted, or modified. To application programmers, however, this approach would be quite convenient because the standard functions would always be available.

Another approach would be to put all of the standard C functions in a single relocatable object module, say, `libc.o`, that application programmers could link into their executables:

```
linux> gcc main.c /usr/lib/libc.o
```

This approach has the advantage that it would decouple the implementation of the standard functions from the implementation of the compiler, and would still be reasonably convenient for programmers. However, a big disadvantage is that every executable file in a system would now contain a complete copy of the collection of standard functions, which would be extremely wasteful of disk space. (On our system, `libc.a` is about 5 MB and `libm.a` is about 2 MB.) Worse, each running program would now contain its own copy of these functions in memory, which would be extremely wasteful of memory. Another big disadvantage is that any change to any standard function, no matter how small, would require the library developer to recompile the entire source file, a time-consuming operation that would complicate the development and maintenance of the standard functions.

We could address some of these problems by creating a separate relocatable file for each standard function and storing them in a well-known directory. However, this approach would require application programmers to explicitly link the appropriate object modules into their executables, a process that would be error prone and time consuming:

```
linux> gcc main.c /usr/lib/printf.o /usr/lib/scanf.o . . .
```

The notion of a static library was developed to resolve the disadvantages of these various approaches. Related functions can be compiled into separate object modules and then packaged in a single static library file. Application programs can then use any of the functions defined in the library by specifying a single filename on the command line. For example, a program that uses functions from the C standard library and the math library could be compiled and linked with a command of the form

```
linux> gcc main.c /usr/lib/libm.a /usr/lib/libc.a
```

(a) `addvec.o`

-----[code/link/addvec.c](#)

```
|  
1   int addcnt = 0; 2  
3   void addvec(int *x, int *y,  
4                   int *z, int n)  
5   {  
6       int i;  
7  
8       addcnt++;  
9  
10      for (i = 0; i < n; i++)  
11          z[i] = x[i] + y[i];  
12  }
```

-----[code/link/addvec.c](#)

(b) `multvec.o`

-----[code/link/multvec.c](#)

```

1   int multcnt = 0;
2
3   void multvec(int *x, int *y,
4               int *z, int n)
5   {
6       int i;
7
8       multcnt++;
9
10      for (i = 0; i < n; i++)
11          z[i] = x[i] * y[i];
12  }

```

-----code/link/multvec.c

**Figure 7.6 Member object files in the `libvector` library.**

At link time, the linker will only copy the object modules that are referenced by the program, which reduces the size of the executable on disk and in memory. On the other hand, the application programmer only needs to include the names of a few library files. (In fact, C compiler drivers always pass `libc.a` to the linker, so the reference to `libc.a` mentioned previously is unnecessary.)

On Linux systems, static libraries are stored on disk in a particular file format known as an *archive*. An archive is a collection of



concatenated relocatable object files, with a header that describes the size and location of each member object file. Archive filenames are denoted with the `.a` suffix.

To make our discussion of libraries concrete, consider the pair of vector routines in [Figure 7.6](#). Each routine, defined in its own object module, performs a vector operation on a pair of input vectors and stores the result in an output vector. As a side effect, each routine records the number of times it has been called by incrementing a global variable. (This will be useful when we explain the idea of position-independent code in [Section 7.12](#).)

To create a static library of these functions, we would use the `AR` tool as follows:

```
linux> gcc -c addvec.c multvec.c
```

```
linux> ar rcs libvector.a addvec.o multvec.o
```

To use the library, we might write an application such as `main2.c` in [Figure 7.7](#), which invokes the `addvec` library routine. The include (or header) file `vector.h` defines the function prototypes for the routines in `libvector.a`,

To build the executable, we would compile and link the input files `main2.o` and `libvector.a`:

```
linux> gcc -c main2.c
```

```
linux> gcc -static -o prog2c main2.o . /libvector.a
```

-----code/link/main2.c

```
|
1  #include <stdio.h>
2  #include "vector.h"
3
4  int x[2] = {1, 2};
5  int y[2] = {3, 4};
6  int z[2];
7
8  int main()
9  {
10     addvec(x, y, z, 2);
11     printf("z = [%d %d] n", z[0], z[1]);
12     return 0;
13 }
```

-----code/link/main2.c

### Figure 7.7 Example program 2.

This program invokes a function in the `libvector` library.

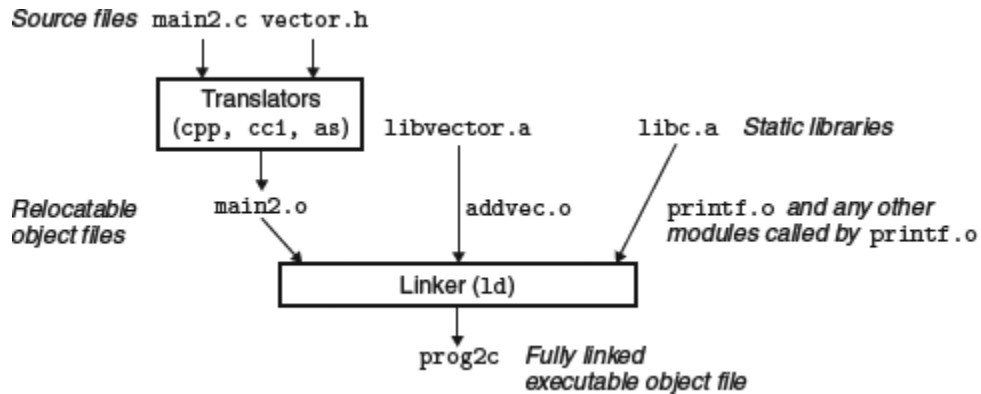


Figure 7.8 Linking with static libraries.

or equivalently,

```
linux> gcc -c main2.c
linux> gcc -static -o prog2c main2.o -L. -lvector
```

Figure 7.8 summarizes the activity of the linker. The `-static` argument tells the compiler driver that the linker should build a fully linked executable object file that can be loaded into memory and run without any further linking at load time. The `-lvector` argument is a shorthand for `libvector.a`, and the `-L.` argument tells the linker to look for `libvector.a` in the current directory.

When the linker runs, it determines that the `addvec` symbol defined by `addvec.o` is referenced by `main2.o`, so it copies `addvec.o` into the executable. Since the program doesn't reference any symbols defined by `multvec.o`, the linker does *not* copy this module into the

executable. The linker also copies the `printf.o` module from `libc.a`, along with a number of other modules from the C run-time system.

## 7.6.3 How Linkers Use Static Libraries to Resolve References

While static libraries are useful, they are also a source of confusion to programmers because of the way the Linux linker uses them to resolve external references. During the symbol resolution phase, the linker scans the relocatable object files and archives left to right in the same sequential order that they appear on the compiler driver's command line. (The driver automatically translates any `.c files` on the command line into `.o files`.) During this scan, the linker maintains a set  $E$  of relocatable object files that will be merged to form the executable, a set  $U$  of unresolved symbols (i.e., symbols referred to but not yet defined), and a set  $D$  of symbols that have been defined in previous input files. Initially,  $E$ ,  $U$ , and  $D$  are empty.

- For each input file  $f$  on the command line, the linker determines if  $f$  is an object file or an archive. If  $f$  is an object file, the linker adds  $f$  to  $E$ , updates  $U$  and  $D$  to reflect the symbol definitions and references in  $f$ , and proceeds to the next input file.
- If  $f$  is an archive, the linker attempts to match the unresolved symbols in  $U$  against the symbols defined by the members of the archive. If some archive member  $m$  defines a symbol that resolves a reference in  $U$ , then  $m$  is added to  $E$ , and the linker updates  $U$  and  $D$  to reflect the symbol definitions and references in  $m$ . This process iterates over the member object files in the archive until a fixed point is reached where  $U$  and  $D$  no longer

change. At this point, any member object files not contained in  $E$  are simply discarded and the linker proceeds to the next input file.

- If  $U$  is nonempty when the linker finishes scanning the input files on the command line, it prints an error and terminates. Otherwise, it merges and relocates the object files in  $E$  to build the output executable file.

Unfortunately, this algorithm can result in some baffling link-time errors because the ordering of libraries and object files on the command line is significant. If the library that defines a symbol appears on the command line before the object file that references that symbol, then the reference will not be resolved and linking will fail. For example, consider the following:

```
linux> gcc -static . /libvector.a main2.c
/tmp/cc9XH6Rp.o: In function `main':
/tmp/cc9XH6Rp.o(.text+0x18): undefined reference to `addvec'
```

What happened? When `libvector.a` is processed,  $U$  is empty, so no member object files from `libvector.a` are added to  $E$ . Thus, the reference to `addvec` is never resolved and the linker emits an error message and terminates.

The general rule for libraries is to place them at the end of the command line. If the members of the different libraries are independent, in that no member references a symbol defined by

another member, then the libraries can be placed at the end of the command line in any order. If, on the other hand, the libraries are not independent, then they must be ordered so that for each symbol `s` that is referenced externally by a member of an archive, at least one definition of `s` follows a reference to `s` on the command line. For example, suppose `foo.c` calls functions in `libx.a` and `libz.a` that call functions in `liby.a`. Then `libx.a` and `libz.a` must precede `liby.a` on the command line:

```
linux> gcc foo.c libx.a libz.a liby.a
```

Libraries can be repeated on the command line if necessary to satisfy the dependence requirements. For example, suppose `foo.c` calls a function in `libx.a` that calls a function in `liby.a` that calls a function in `libx.a`. Then `libx.a` must be repeated on the command line:

```
linux> gcc foo.c libx.a liby.a libx.a
```

Alternatively, we could combine `libx.a` and `liby.a` into a single archive.

## Practice Problem 7.3 (solution page 718)

Let  $a$  and  $b$  denote object modules or static libraries in the current directory, and let  $a \rightarrow b$  denote that  $a$  depends on  $b$ , in the sense that  $b$  defines a symbol that is referenced by  $a$ . For each of the following scenarios, show the minimal command line (i.e., one with the least number of object file and library arguments) that will allow the static linker to resolve all symbol references.

A. `p.o → libx.a`

B. `p.o → libx.a → liby.a`

C. `p.o → libx.a → liby.a and liby.a → libx.a → p.o`



## 7.7 Relocation


Once the linker has completed the symbol resolution step, it has associated each symbol reference in the code with exactly one symbol definition (i.e., a symbol table entry in one of its input object modules). At this point, the linker knows the exact sizes of the code and data sections in its input object modules. It is now ready to begin the relocation step, where it merges the input modules and assigns run-time addresses to each symbol. Relocation consists of two steps:

1. **Relocating sections and symbol definitions.** In this step, the linker merges all sections of the same type into a new aggregate section of the same type. For example, the `.data` sections from the input modules are all merged into one section that will become the `.data` section for the output executable object file. The linker then assigns run-time memory addresses to the new aggregate sections, to each section defined by the input modules, and to each symbol defined by the input modules. When this step is complete, each instruction and global variable in the program has a unique run-time memory address.
2. **Relocating symbol references within sections.** In this step, the linker modifies every symbol reference in the bodies of the code and data sections so that they point to the correct run-time addresses. To perform this step, the linker relies on data


structures in the relocatable object modules known as relocation entries, which we describe next.

## 7.7.1 Relocation Entries

When an assembler generates an object module, it does not know where the code and data will ultimately be stored in memory. Nor does it know the locations of any externally defined functions or global variables that are referenced by the module. So whenever the assembler encounters a reference to an object whose ultimate location is unknown, it generates a *relocation entry* that tells the linker how to modify the reference when it merges the object file into an executable. Relocation entries for code are placed in `.rel.text`. Relocation entries for data are placed in `.rel.data`.

**Figure 7.9**  shows the format of an ELF relocation entry. The `offset` is the section offset of the reference that will need to be modified. The `symbol` identifies the symbol that the modified reference should point to. The `type` tells the linker how to modify the new reference. The `addend` is a signed constant that is used by some types of relocations to bias the value of the modified reference.

ELF defines 32 different relocation types, many quite arcane. We are concerned with only the two most basic relocation types:

`R_X86_64_PC32`. Relocate a reference that uses a 32-bit PC-relative address. Recall from **Section 3.6.3**  that a PC-relative address is an offset from the current run-time value of the program counter (PC). When the CPU executes an instruction

using PC-relative addressing, it forms the *effective address* (e.g., the target of the call instruction) by adding the 32-bit value

-----code/link/elfstructs.c

```
1     typedef struct {
2         long offset;          /* Offset of the
reference to relocate */
3         long type:32,        /* Relocation type */
4         long symbol:32;     /* Symbol table index
*/
5         long addend;        /* Constant part of
relocation expression */
6     } Elf64_Rela;
```

-----code/link/elfstructs.c

### Figure 7.9 ELF relocation entry.



Each entry identifies a reference that must be relocated and specifies how to compute the modified reference.

encoded in the instruction to the current run-time value of the PC, which is always the address of the next instruction in memory.

`R_X86_64_32`. Relocate a reference that uses a 32-bit absolute address. With absolute addressing, the CPU directly uses the 32-bit value encoded in the instruction as the effective address, without further modifications.

These two relocation types support the x86-64 *small code model*, which assumes that the total size of the code and data in the executable object file is smaller than 2 GB, and thus can be accessed at run-time using 32-bit PC-relative addresses. The small code model is the default for `gcc`. Programs larger than 2 GB can be compiled using the `-mmodel=medium` (*medium code model*) and `-mmodel=large` (*large code model*) flags, but we won't discuss those.

## 7.7.2 Relocating Symbol References

**Figure 7.10**  shows the pseudocode for the linker's relocation algorithm. Lines 1 and 2 iterate over each section `s` and each relocation entry `r` associated with each section. For concreteness, assume that each section `s` is an array of bytes and that each relocation entry `r` is a `struct` of type `Elf64_Rel`, as defined in **Figure 7.9** . Also, assume that when the algorithm runs, the linker has already chosen runtime addresses for each section (denoted `ADDR(s)`) and each symbol (denoted `ADDR(r.symbol)`). Line 3 computes the address in the `s` array of the 4-byte reference that needs to be relocated. If this reference uses PC-relative addressing, then it is relocated by lines 5–9. If the reference uses absolute addressing, then it is relocated by lines 11–13.

```

1     foreach section s {
2         foreach relocation entry r {
3             refptr = s + r.offset; /* ptr to
reference to be relocated */
4
5             /* Relocate a PC-relative reference */
6             if (r.type == R_X86_64_PC32) {
7                 refaddr = ADDR(s) + r.offset; /*
ref's run-time address */
8                 *refptr = (unsigned)
(ADDR(r.symbol) + r.addend - refaddr);
9             }
10
11            /* Relocate an absolute reference */
12            if (r.type == R_X86_64_32)
13                *refptr = (unsigned)
(ADDR(r.symbol) + r.addend);
14        }
15    }

```

**Figure 7.10 Relocation algorithm.**

-----code/link/main-relo.d

```
|
1      0000000000000000 <main>:
2      0: 4883ec08          sub      $0x8, %rsp
3      4: be 02 00 00 00     mov     $0x2, %esi
4      9: bf 00 00 00 00     mov     $0x0, %edi
%edi = &array
5      a: R_X86_64_32 array
Relocation entry
6      e: e8 00 00 00 00     callq   13 <main+0x13>
sum()
7      f: R_X86_64_PC32 sum-0x4
Relocation entry
8      13: 4883c408         add     $0x8, %rsp
9      17:c3          retq
```

-----code/link/main-relo.d

**Figure 7.11** Code and relocation entries from `main.o`.

The original C code is in [Figure 7.1](#).

Let's see how the linker uses this algorithm to relocate the references in our example program in [Figure 7.1](#). [Figure 7.11](#) shows the disassembled code from `main.o`, as generated by the GNU OBJDUMP tool (`objdump -dx main.o`).



The main function references two global symbols, `array` and `sum`. For each reference, the assembler has generated a relocation entry, which is displayed on the following line.<sup>2</sup> The relocation entries tell the linker that the reference to `sum` should be relocated using a 32-bit PC-relative address, and the reference to `array` should be relocated using a 32-bit absolute address. The next two sections detail how the linker relocates these references.

**2.** Recall that relocation entries and instructions are actually stored in different sections of the object file. The `OBJDUMP` tool displays them together for convenience.

## Relocating PC-Relative References

In line 6 in [Figure 7.11](#), function `main` calls the `sum` function, which is defined in module `sum.o`. The `call` instruction begins at section offset `0xe` and consists of the 1-byte opcode `0xe8`, followed by a placeholder for the 32-bit PC-relative reference to the target `sum`.

The corresponding relocation entry `r` consists of four fields:

```
|  
r.offset = 0xf  
r.symbol = sum  
r.type = R_X86_64_PC32  
r.addend = -4
```

These fields tell the linker to modify the 32-bit PC-relative reference starting at offset `0xf` so that it will point to the `sum` routine at run time. Now, suppose that the linker has determined that

```
|  
ADDR(s) = ADDR(.text) = 0x4004d0
```

and

```
ADDR(r.symbol) = ADDR(sum) = 0x4004e8
```

Using the algorithm in [Figure 7.10](#), the linker first computes the run-time address of the reference (line 7):

```
|  
refaddr = ADDR(s) + r.offset  
         = 0x4004d0 + 0xf  
         = 0x4004df
```

It then updates the reference so that it will point to the sum routine at run time (line 8):

```
|  
*refptr = (unsigned) (ADDR(r.symbol) + r.addend - refaddr)  
          = (unsigned) (0x4004e8 + (-4) - 0x4004df)  
          = (unsigned) (0x5)
```

In the resulting executable object file, the call instruction has the following relocated form:

```
4004de: e8 05 00 00 00 callq 4004e8 <sum>    sum()
```

At run time, the call instruction will be located at address `0x4004de`. When the CPU executes the call instruction, the PC has a value of `0x4004e3`, which is the address of the instruction immediately following the `call` instruction. To execute the call instruction, the CPU performs the following steps:

1. Push PC onto stack
2.  $PC \leftarrow PC + 0x5 = 0x4004e3 + 0x5 = 0x4004e8$

Thus, the next instruction to execute is the first instruction of the `sum` routine, which of course is what we want!

## Relocating Absolute References

Relocating absolute references is straightforward. For example, in line 4 in [Figure 7.11](#), the `mov` instruction copies the address of `array` (a 32-bit immediate value) into register `%edi`. The `mov` instruction begins at section offset `0x9` and consists of the 1-byte opcode `0xbf`, followed by a placeholder for the 32-bit absolute reference to `array`.

The corresponding relocation entry `r` consists of four fields:

```
r.offset = 0xa
r.symbol = array
r.type = R_X86_64_32
r.addend = 0
```

These fields tell the linker to modify the absolute reference starting at offset `0xa` so that it will point to the first byte of `array` at run time.

Now, suppose that the linker has determined that

(a) Relocated `.text` section

```
|
1      000000000004004d0 <main>:
2      4004d0: 48 83 ec 08          sub    $0x8, %rsp
3      4004d4: be 02 00 00 00      mov    $0x2, %esi
4      4004d9: bf 18 10 60 00      mov    $0x601018, %edi
%edi = &array
5      4004de: e8 05 00 00 00      callq 4004e8 <sum>
sum()
6      4004e3: 48 83 c4 08          add    $0x8, %rsp
7      4004e7: c3                  retq
8      000000000004004e8 <sum>:
9      4004e8: b8 00 00 00 00      mov    $0x0, %eax
10     4004ed: ba 00 00 00 00      mov    $0x0, %edx
11     4004f2: eb 09              jmp    4004fd
<sum+0x15>
12     4004f4: 48 63 ca          movslq %edx, %rcx
13     4004f7: 03 04 8f          add    (%rdi, %rcx,4),
%eax
14     4004fa: 83 c2 01          add    $0x1, %edx
15     4004fd: 39 f2            cmp    %esi, %edx
16     4004ff: 7c f3            jl    4004f4 <sum+0xc>
17     400501: f3 c3            repz retq
```

(b) Relocated `.data` section

```
1      000000000000601018 <array>:  
2      601018: 01 00 00 00 02 00 00 00
```

**Figure 7.12 Relocated `.text` and `.data` sections for the executable file `prog`.**

The original C code is in [Figure 7.1](#).

```
ADDR(r.symbol) = ADDR(array) = 0x601018
```

The linker updates the reference using line 13 of the algorithm in [Figure 7.10](#):

```
*refptr = (unsigned) (ADDR(r.symbol) + r.addend)  
          = (unsigned) (0x601018 + 0)  
          = (unsigned) (0x601018)
```

In the resulting executable object file, the reference has the following relocated form:

```
4004d9: bf 18 10 60 00      mov     $0x601018, %edi  %edi =  
&array
```

Putting it all together, [Figure 7.12](#) shows the relocated `.text` and `.data` sections in the final executable object file. At load time, the loader can copy the bytes from these sections directly into memory and execute the instructions without any further modifications.

## Practice Problem 7.4 (solution page [718](#))

This problem concerns the relocated program in [Figure 7.12\(a\)](#).

- A. What is the hex address of the relocated reference to `sum` in line 5?
- B. What is the hex value of the relocated reference to `sum` in line 5?



## Practice Problem 7.5 (solution page [718](#))

Consider the call to function `swap` in object file `m.o` ([Figure 7.5](#)).

```
9: e8 00 00 00 00      callq   e <main+0xe>   swap()
```

with the following relocation entry:

```
r.offset = 0xa  
r.symbol = swap  
r.type = R_X86_64_PC32  
r.addend = -4
```

Now suppose that the linker relocates `.text` in `m.o` to address `0x4004d0` and `swap` to address `0x4004e8`. Then what is the value of the relocated reference to `swap` in the `callq` instruction?

# 7.8 Executable Object Files

We have seen how the linker merges multiple object files into a single executable object file. Our example C program, which began life as a collection of ASCII text files, has been transformed into a single binary file that contains all of the information needed to load the program into memory and run it. [Figure 7.13](#) summarizes the kinds of information in a typical ELF executable file.

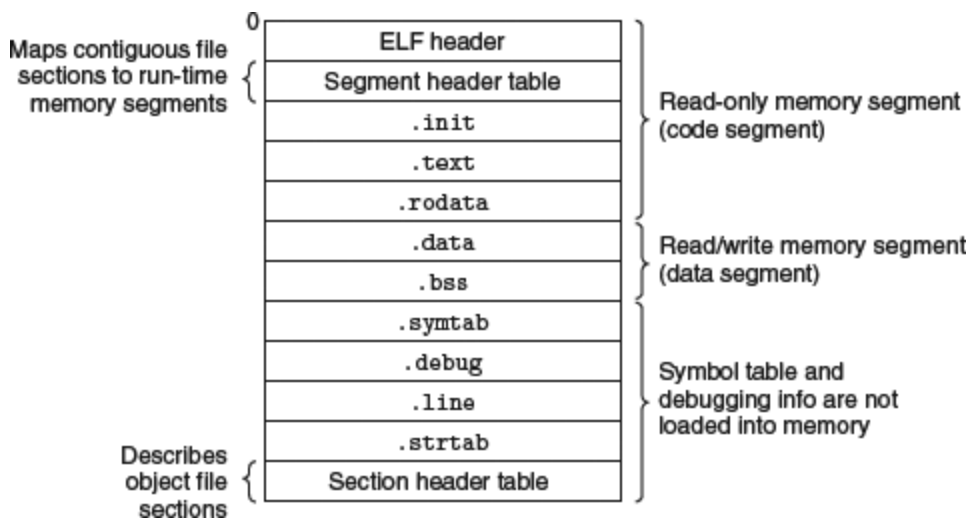


Figure 7.13 Typical ELF executable object file.

-----code/link/prog-exe.d

```
|
|
|   Read-only code segment
1   LOAD off          0x0000000000000000 vaddr
|   0x0000000000400000 paddr 0x0000000000400000 align 2**21
2   filesz 0x0000000000000069c memsz 0x0000000000000069c
|   flags r-x
|
|   Read/write data segment
3   LOAD off          0x0000000000000df8 vaddr
|   0x0000000000600df8 paddr 0x0000000000600df8 align 2**21
4   filesz 0x0000000000000228 memsz 0x0000000000000230
|   flags rw-
```


-----code/link/prog-exe.d

**Figure 7.14 Program header table for the example executable prog.**

`off`: offset in object file; `vaddr/paddr`: memory address; `align`: alignment requirement; `filesz`: segment size in object file; `memsz`: segment size in memory; `flags`: run-time permissions.

The format of an executable object file is similar to that of a relocatable object file. The ELF header describes the overall format of the file. It also includes the program's *entry point*, which is the address of the first instruction to execute when the program runs. The `.text`, `.rodata`, and `.data` sections are similar to those in a

relocatable object file, except that these sections have been relocated to their eventual run-time memory addresses. The `.init` section defines a small function, called `_init`, that will be called by the program's initialization code. Since the executable is *fully linked* (relocated), it needs no `.rel` sections.

ELF executables are designed to be easy to load into memory, with contiguous chunks of the executable file mapped to contiguous memory segments. This mapping is described by the *program header table*. **Figure 7.14**  shows part of the program header table for our example executable `prog`, as displayed by `OBJDUMP`.

From the program header table, we see that two memory segments will be initialized with the contents of the executable object file. Lines 1 and 2 tell us that the first segment (the *code segment*) has read/execute permissions, starts at memory address `0x400000`, has a total size in memory of `0x69c` bytes, and is initialized with the first `0x69c` bytes of the executable object file, which includes the ELF header, the program header table, and the `.init`, `.text`, and `.rodata` sections.

Lines 3 and 4 tell us that the second segment (the *data segment*) has read/write permissions, starts at memory address `0x600df8`, has a total memory size of `0x230` bytes, and is initialized with the `0x228` bytes in the `.data` section starting at offset `0xdf8` in the object file. The remaining 8 bytes in the segment correspond to `.bss` data that will be initialized to zero at run time.

For any segment  $s$ , the linker must choose a starting address, `vaddr`, such that

$$\text{vaddr mod align} = \text{off mod align}$$

where `off` is the offset of the segment's first section in the object file, and `align` is the alignment specified in the program header ( $2^{21} = 0x2000000$ ). For example, in the data segment in [Figure 7.14](#),

$$\text{vaddr mod align} = 0x600df8 \text{ mod } 0x2000000 = 0xdf8$$

and

$$\text{off mod align} = 0xdf8 \text{ mod } 0x2000000 = 0xdf8$$

This alignment requirement is an optimization that enables segments in the object file to be transferred efficiently to memory when the program executes. The reason is somewhat subtle and is due to the way that virtual memory is organized as large contiguous power-of-2 chunks of bytes. You will learn all about virtual memory in [Chapter 9](#).

## 7.9 Loading Executable Object Files

To run an executable object file `prog`, we can type its name to the Linux shell's command line:

```
linux> ./prog
```

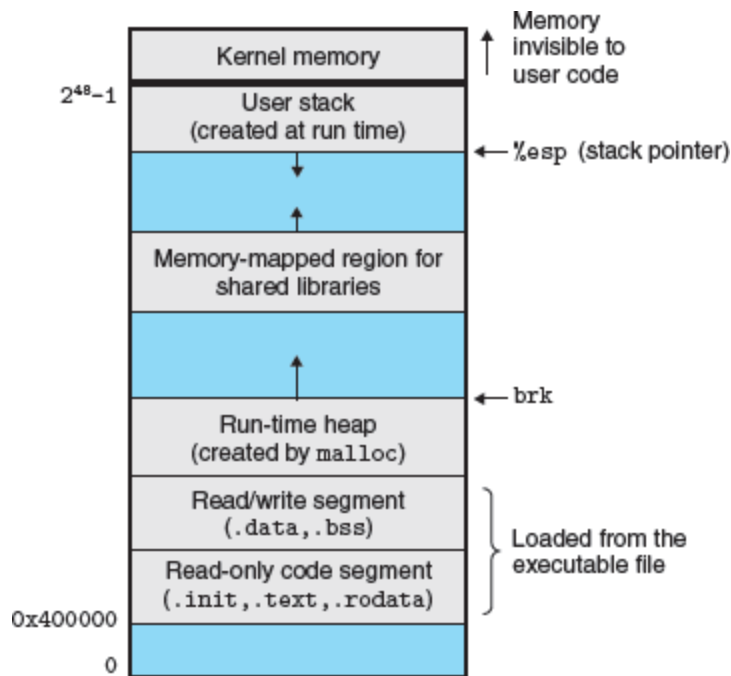
Since `prog` does not correspond to a built-in shell command, the shell assumes that `prog` is an executable object file, which it runs for us by invoking some memory-resident operating system code known as the `loader`. Any Linux program can invoke the loader by calling the `execve` function, which we will describe in detail in [Section 8.4.6](#). The loader copies the code and data in the executable object file from disk into memory and then runs the program by jumping to its first instruction, or *entry point*. This process of copying the program into memory and then running it is known as *loading*.

Every running Linux program has a run-time memory image similar to the one in [Figure 7.15](#). On Linux x86-64 systems, the code segment starts at address `0x400000`, followed by the data segment. The run-time *heap* follows the data segment and grows upward via calls to the `malloc` library. (We will describe `malloc` and the heap in

detail in [Section 9.9](#).) This is followed by a region that is reserved for shared modules. The user stack starts below the largest legal user address ( $2^{48} - 1$ ) and grows down, toward smaller memory addresses. The region above the stack, starting at address  $2^{48}$ , is reserved for the code and data in the *kernel*, which is the memory-resident part of the operating system.

For simplicity, we've drawn the heap, data, and code segments as abutting each other, and we've placed the top of the stack at the largest legal user address. In practice, there is a gap between the code and data segments due to the alignment requirement on the `.data` segment ([Section 7.8](#)). Also, the linker uses address-space layout randomization (ASLR, [Section 3.10.4](#)) when it assigns runtime addresses to the stack, shared library, and heap segments. Even though the locations of these regions change each time the program is run, their relative positions are the same.

When the loader runs, it creates a memory image similar to the one shown in [Figure 7.15](#). Guided by the program header table, it copies chunks of the



**Figure 7.15 Linux x86-64 run-time memory image.**

Gaps due to segment alignment requirements and address-space layout randomization (ASLR) are not shown. Not to scale.

executable object file into the code and data segments. Next, the loader jumps to the program's entry point, which is always the address of the `_start` function. This function is defined in the system object file `crt1.o` and is the same for all C programs. The `_start` function calls the *system startup function*, `__libc_start_main`, which is defined in `libc.so`. It initializes the execution environment, calls the user-level `main` function, handles its return value, and if necessary returns control to the kernel.



## 7.10 Dynamic Linking with Shared Libraries

The static libraries that we studied in [Section 7.6.2](#) address many of the issues associated with making large collections of related functions available to application programs. However, static libraries still have some significant disadvantages. Static libraries, like all software, need to be maintained and updated periodically. If application programmers want to use the most recent version of a library, they must somehow become aware that the library has changed and then explicitly relink their programs against the updated library.

Another issue is that almost every C program uses standard I/O functions such as `printf` and `scanf`. At run time, the code for these functions is duplicated in the text segment of each running process. On a typical system that is running hundreds of processes, this can be a significant waste of scarce memory system resources. (An interesting property of memory is that it is *always* a scarce resource, regardless

## Aside How do loaders really work?

Our description of loading is conceptually correct but intentionally not entirely accurate. To understand how loading really works, you must understand the concepts of *processes*, *virtual memory*, and *memory mapping*, which we haven't discussed yet. As we encounter these concepts later in [Chapters 8](#) and [9](#), we will revisit loading and gradually reveal the mystery to you.

For the impatient reader, here is a preview of how loading really works: Each program in a Linux system runs in the context of a process with its own virtual address space. When the shell runs a program, the parent shell process forks a child process that is a duplicate of the parent. The child process invokes the loader via the `execve` system call. The loader deletes the child's existing virtual memory segments and creates a new set of code, data, heap, and stack segments. The new stack and heap segments are initialized to zero. The new code and data segments are initialized to the contents of the executable file by mapping pages in the virtual address space to page-size chunks of the executable file. Finally, the loader jumps to the `_start` address, which eventually calls the application's `main` routine. Aside from some header information, there is no copying of data from disk to memory during loading. The copying is deferred until the CPU references a mapped virtual page, at which point the

operating system automatically transfers the page from disk to memory using its paging mechanism.

of how much there is in a system. Disk space and kitchen trash cans share this same property.)

*Shared libraries* are modern innovations that address the disadvantages of static libraries. A shared library is an object module that, at either run time or load time, can be loaded at an arbitrary memory address and linked with a program in memory. This process is known as *dynamic linking* and is performed by a program called a *dynamic linker*. Shared libraries are also referred to as *shared objects*, and on Linux systems they are indicated by the `.so` suffix. Microsoft operating systems make heavy use of shared libraries, which they refer to as DLLs (dynamic link libraries).

Shared libraries are "shared" in two different ways. First, in any given file system, there is exactly one `.so` file for a particular library. The code and data in this `.so` file are shared by all of the executable object files that reference the library, as opposed to the contents of static libraries, which are copied and embedded in the executables that reference them. Second, a single copy of the `.text` section of a shared library in memory can be shared by different running processes. We will explore this in more detail when we study virtual memory in [Chapter 9](#).

[Figure 7.16](#) summarizes the dynamic linking process for the example program in [Figure 7.7](#). To build a shared library `libvector.so` of our example vector routines in [Figure 7.6](#), we

invoke the compiler driver with some special directives to the compiler and linker:

```
linux> gcc -shared -fpic -o libvector.so addvec.c multvec.c
```

The `-fpic` flag directs the compiler to generate *position-independent code* (more on this in the next section). The `-shared` flag directs the linker to create a shared

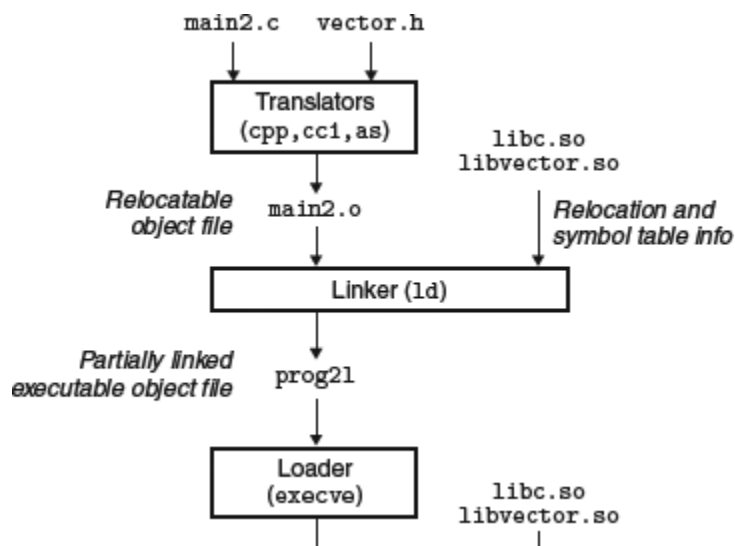



Figure 7.16 Dynamic linking with shared libraries.

object file. Once we have created the library, we would then link it into our example program in [Figure 7.7](#) :

```
linux> gcc -o prog21 main2.c ./libvector.so
```

This creates an executable object file `prog21` in a form that can be linked with `libvector.so` at run time. The basic idea is to do some of the linking statically when the executable file is created, and then complete the linking process dynamically when the program is loaded. It is important to realize that none of the code or data sections from `libvector.so` are actually copied into the executable `prog21` at this point. Instead, the linker copies some relocation and symbol table information that will allow references to code and data in `libvector.so` to be resolved at load time.

When the loader loads and runs the executable `prog21`, it loads the partially linked executable `prog21`, using the techniques discussed in [Section 7.9](#). Next, it notices that `prog21` contains a `.interp` section, which contains the path name of the dynamic linker, which is itself a shared object (e.g., `ld-linux.so` on Linux systems). Instead of passing control to the application, as it would normally do, the loader loads and runs the dynamic linker. The dynamic linker then finishes the linking task by performing the following relocations:

- Relocating the text and data of `libc.so` into some memory segment
- Relocating the text and data of `libvector.so` into another memory segment
- Relocating any references in `prog21` to symbols defined by `libc.so` and `libvector.so`

Finally, the dynamic linker passes control to the application. From this point on, the locations of the shared libraries are fixed and do not change during execution of the program.

[OceanofPDF.com](http://OceanofPDF.com)

## 7.11 Loading and Linking Shared Libraries from Applications

Up to this point, we have discussed the scenario in which the dynamic linker loads and links shared libraries when an application is loaded, just before it executes. However, it is also possible for an application to request the dynamic linker to load and link arbitrary shared libraries while the application is running, without having to link in the applications against those libraries at compile time.

Dynamic linking is a powerful and useful technique. Here are some examples in the real world:

- **Distributing software.** Developers of Microsoft Windows applications frequently use shared libraries to distribute software updates. They generate a new copy of a shared library, which users can then download and use as a replacement for the current version. The next time they run their application, it will automatically link and load the new shared library.
- **Building high-performance Web servers.** Many Web servers generate *dynamic content*, such as personalized Web pages, account balances, and banner ads. Early Web servers generated dynamic content by using `fork` and `execve` to create a child process and run a "CGI program" in the context of the child. However, modern high-performance Web servers can generate

dynamic content using a more efficient and sophisticated approach based on dynamic linking.

The idea is to package each function that generates dynamic content in a shared library. When a request arrives from a Web browser, the server dynamically loads and links the appropriate function and then calls it directly, as opposed to using `fork` and `execve` to run the function in the context of a child process. The function remains cached in the server's address space, so subsequent requests can be handled at the cost of a simple function call. This can have a significant impact on the throughput of a busy site. Further, existing functions can be updated and new functions can be added at run time, without stopping the server.

Linux systems provide a simple interface to the dynamic linker that allows application programs to load and link shared libraries at run time.

```
#include <dlfcn.h>
void *dlopen(const char *filename, int flag);
Returns: pointer to handle if
OK, NULL on error
```

The `dlopen` function loads and links the shared library `filename`. The external symbols in `filename` are resolved using libraries previously opened with the `RTLD_GLOBAL` flag. If the current executable was



compiled with the `-rdynamic` flag, then its global symbols are also available for symbol resolution. The `flag` argument must include either `RTLD_NOW`, which tells the linker to resolve references to external symbols immediately, or the `RTLD_LAZY` flag, which instructs the linker to defer symbol resolution until code from the library is executed. Either of these values can be ORed with the `RTLD_GLOBAL` flag.

```
#include <dlfcn.h>
void *dlsym(void *handle, char *symbol);
Returns: pointer to symbol if
OK, NULL on error
```


The `dlsym` function takes a handle to a previously opened shared library and a `symbol` name and returns the address of the symbol, if it exists, or NULL otherwise.

```
#include <dlfcn.h>
int dlclose (void *handle);
Returns: 0 if OK, -1 on error
```

The `dlclose` function unloads the shared library if no other shared libraries are still using it.

```
#include <dlfcn.h>
const char *dlerror(void);
Returns: error message if previous call to
dlopen, dlsym, or dlclose failed;
NULL if previous call was OK
```

The `dlerror` function returns a string describing the most recent error that occurred as a result of calling `dlopen`, `dlsym`, or `dlclose`, or NULL if no error occurred.

**Figure 7.17**  shows how we would use this interface to dynamically link our `libvector.so` shared library at run time and then invoke its `addvec` routine. To compile the program, we would invoke gcc in the following way:

```
linux> gcc -rdynamic -o prog2r dll.c -ldl
```

-----code/link/dll.c

```

1  #include <stdio.h>
2  #include <stdlib.h>
3  #include <dlfcn.h>
4
5  int x[2] = {1, 2};
6  int y[2] = {3, 4};
7  int z[2];
8
9  int main()
10 {
11     void *handle;
12     void (*addvec)(int *, int *, int *, int);
13     char *error;
14
15     /* Dynamically load the shared library
containing addvec() */
16     handle = dlopen("./libvector.so", RTLD_LAZY);
17     if (!handle) {
18         fprintf(stderr, "%sn", dlerror());
19         exit(1);
20     }
21
22     /* Get a pointer to the addvec() function we
just loaded */
23     addvec = dlsym(handle, "addvec");
24     if ((error = dlerror()) != NULL) {
25         fprintf(stderr, "%sn", error);
26         exit(1);

```

```
27     }
28
29     /* Now we can call addvec() just like any other
function */
30     addvec(x, y, z, 2);
31     printf("z = [%d %d]n", z[0], z[1]);
32
33     /* Unload the shared library */
34     if (dlclose(handle) < 0) {
35         fprintf(stderr, "%sn", dlerror());
36         exit(1);
37     }
38     return 0;
39 }
```

-----code/link/dll.c

**Figure 7.17 Example program 3.**

Dynamically loads and links the shared library `libvector.so` at run time.

# Aside Shared libraries and the Java Native Interface

Java defines a standard calling convention called *Java Native Interface (JNI)* that allows "native" C and C++ functions to be called from Java programs. The basic idea of JNI is to compile the native C function, say, `foo`, into a shared library, say, `foo.so`. When a running Java program attempts to invoke function `foo`, the Java interpreter uses the `dlopen` interface (or something like it) to dynamically link and load `foo.so` and then call `foo`.

[OceanofPDF.com](http://OceanofPDF.com)

## 7.12 Position-Independent Code (PIC)

A key purpose of shared libraries is to allow multiple running processes to share the same library code in memory and thus save precious memory resources. So how can multiple processes share a single copy of a program? One approach would be to assign a priori a dedicated chunk of the address space to each shared library, and then require the loader to always load the shared library at that address. While straightforward, this approach creates some serious problems. It would be an inefficient use of the address space because portions of the space would be allocated even if a process didn't use the library. It would also be difficult to manage. We would have to ensure that none of the chunks overlapped. Each time a library was modified, we would have to make sure that it still fit in its assigned chunk. If not, then we would have to find a new chunk. And if we created a new library, we would have to find room for it. Over time, given the hundreds of libraries and versions of libraries in a system, it would be difficult to keep the address space from fragmenting into lots of small unused but unusable holes. Even worse, the assignment of libraries to memory would be different for each system, thus creating even more management headaches.

To avoid these problems, modern systems compile the code segments of shared modules so that they can be loaded anywhere in

memory without having to be modified by the linker. With this approach, a single copy of a shared module's code segment can be shared by an unlimited number of processes. (Of course, each process will still get its own copy of the read/write data segment.)

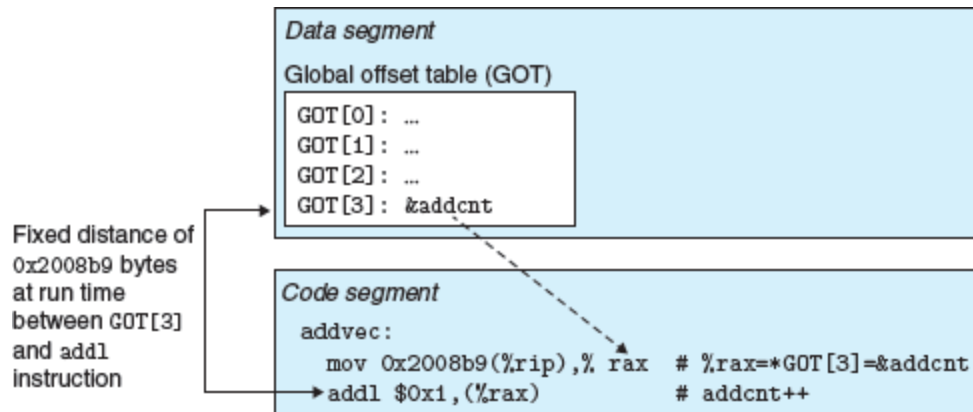
Code that can be loaded without needing any relocations is known as *position-independent code (PIC)*. Users direct GNU compilation systems to generate PIC code with the `-fpic` option to `gcc`. Shared libraries must always be compiled with this option.

On x86-64 systems, references to symbols in the same executable object module require no special treatment to be PIC. These references can be compiled using PC-relative addressing and relocated by the static linker when it builds the object file. However, references to external procedures and global variables that are defined by shared modules require some special techniques, which we describe next.



# PIC Data References

Compilers generate PIC references to global variables by exploiting the following interesting fact: no matter where we load an object module (including shared




**Figure 7.18 Using the GOT to reference a global variable.**

The `addvec` routine in `libvector.so` references `addcnt` indirectly through the GOT for `libvector.so`.

object modules) in memory, the data segment is always the same distance from the code segment. Thus, the *distance* between any instruction in the code segment and any variable in the data segment is a run-time constant, independent of the absolute memory locations of the code and data segments.

Compilers that want to generate PIC references to global variables exploit this fact by creating a table called the *global offset table* (*GOT*) at the beginning of the data segment. The GOT contains an 8-byte entry for each global data object (procedure or global

variable) that is referenced by the object module. The compiler also generates a relocation record for each entry in the GOT. At load time, the dynamic linker relocates each GOT entry so that it contains the absolute address of the object. Each object module that references global objects has its own GOT.

**Figure 7.18**  shows the GOT from our example `libvector.so` shared module. The `addvec` routine loads the address of the global variable `addcnt` indirectly via `GOT[3]` and then increments `addcnt` in memory. The key idea here is that the offset in the PC-relative reference to `GOT[3]` is a run-time constant.

Since `addcnt` is defined by the `libvector.so` module, the compiler could have exploited the constant distance between the code and data segments by generating a direct PC-relative reference to `addcnt` and adding a relocation for the linker to resolve when it builds the shared module. However, if `addcnt` were defined by another shared module, then the indirect access through the GOT would be necessary. In this case, the compiler has chosen to use the most general solution, the GOT, for all references.

## *PIC Function Calls*

Suppose that a program calls a function that is defined by a shared library. The compiler has no way of predicting the run-time address of the function, since the shared module that defines it could be loaded anywhere at run time. The normal approach would be to generate a relocation record for the reference, which the dynamic linker could then resolve when the program was loaded. However, this approach would not be PIC, since it would require the linker to modify the code segment of the calling module. GNU compilation systems solve this problem using an interesting technique, called *lazy binding*, that defers the binding of each procedure address until the *first time* the procedure is called.

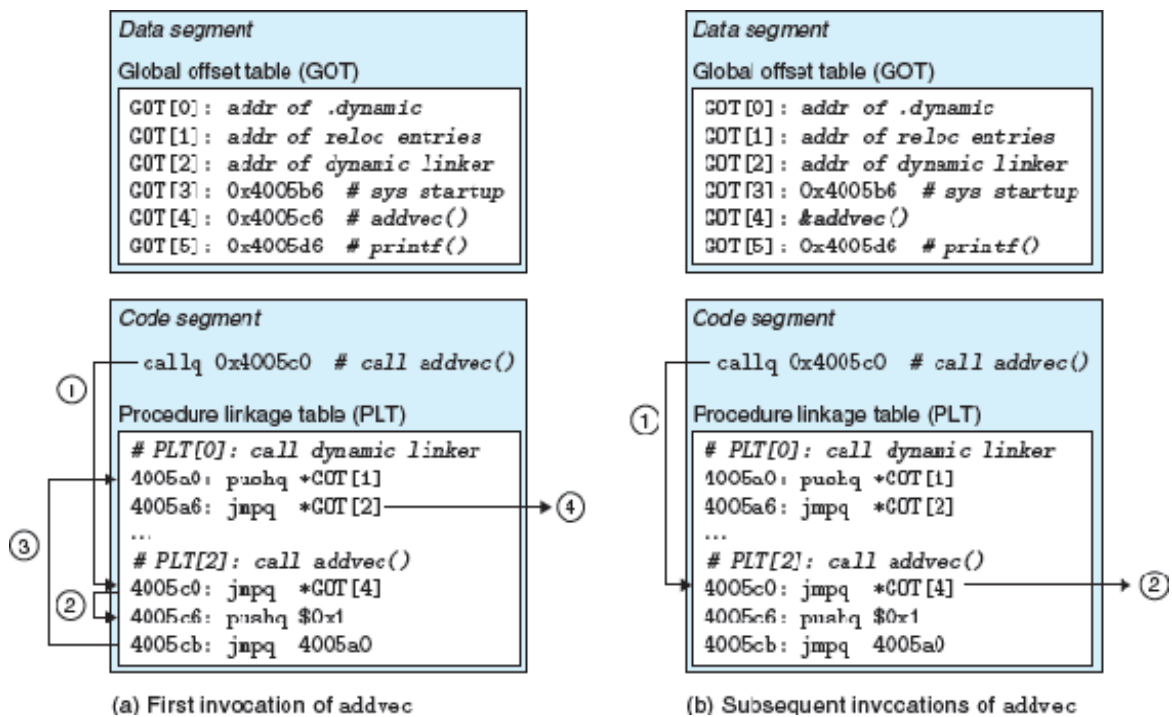
The motivation for lazy binding is that a typical application program will call only a handful of the hundreds or thousands of functions exported by a shared library such as `libc.so`. By deferring the resolution of a function's address until it is actually called, the dynamic linker can avoid hundreds or thousands of unnecessary relocations at load time. There is a nontrivial run-time overhead the first time the function is called, but each call thereafter costs only a single instruction and a memory reference for the indirection.

Lazy binding is implemented with a compact yet somewhat complex interaction between two data structures: the GOT and the *procedure linkage table (PLT)*. If an object module calls any functions that are defined in shared libraries, then it has its own GOT and PLT. The

GOT is part of the data segment. The PLT is part of the code segment.

**Figure 7.19** shows how the PLT and GOT work together to resolve the address of a function at run time. First, let's examine the contents of each of these tables.

**Procedure linkage table (PLT).** The PLT is an array of 16-byte code entries. `PLT[0]` is a special entry that jumps into the dynamic linker. Each shared library function called by the executable has its own PLT entry. Each of




**Figure 7.19** Using the PLT and GOT to call external functions.

The dynamic linker resolves the address of `addvec` the first time it is called.

these entries is responsible for invoking a specific function. `PLT[1]` (not shown here) invokes the system startup function (`__libc_start_main`), which initializes the execution environment, calls the main function, and handles its return value. Entries starting at `PLT[2]` invoke functions called by the user code. In our example, `PLT[2]` invokes `addvec` and `PLT[3]` (not shown) invokes `printf`.

**Global offset table (GOT).** As we have seen, the GOT is an array of 8-byte address entries. When used in conjunction with the PLT, `GOT[0]` and `GOT[1]` contain information that the dynamic linker uses when it resolves function addresses. `GOT[2]` is the entry point for the dynamic linker in the `ld-linux.so` module. Each of the remaining entries corresponds to a called function whose address needs to be resolved at run time. Each has a matching PLT entry. For example, `GOT[4]` and `PLT[2]` correspond to `addvec`. Initially, each GOT entry points to the second instruction in the corresponding PLT entry.

**Figure 7.19(a)**  shows how the GOT and PLT work together to lazily resolve the run-time address of function `addvec` the first time it is called:


Step 1. Instead of directly calling `addvec`, the program calls into `PLT[2]`, which is the PLT entry for `addvec`.

Step 2. The first PLT instruction does an indirect jump through `GOT[4]`. Since each GOT entry initially points to the second

instruction in its corresponding PLT entry, the indirect jump simply transfers control back to the next instruction in `PLT[2]`.

Step 3. After pushing an ID for `addvec (0x1)` onto the stack, `PLT[2]` jumps to `PLT[0]`.

Step 4. `PLT[0]` pushes an argument for the dynamic linker indirectly through `GOT[1]` and then jumps into the dynamic linker indirectly through `GOT[2]`. The dynamic linker uses the two stack entries to determine the runtime location of `addvec`, overwrites `GOT[4]` with this address, and passes control to `addvec`.

**Figure 7.19(b)**  shows the control flow for any subsequent invocations of `addvec`:


Step 1. Control passes to `PLT[2]` as before.

Step 2. However, this time the indirect jump through `GOT[4]` transfers control directly to `addvec`.

## 7.13 Library Interpositioning

Linux linkers support a powerful technique, called *library interpositioning*, that allows you to intercept calls to shared library functions and execute your own code instead. Using interpositioning, you could trace the number of times a particular library function is called, validate and trace its input and output values, or even replace it with a completely different implementation.




Here's the basic idea: Given some *target function* to be interposed on, you create a *wrapper function* whose prototype is identical to the target function. Using some particular interpositioning mechanism, you then trick the system into calling the wrapper function instead of the target function. The wrapper function typically executes its own logic, then calls the target function and passes its return value back to the caller.

Interpositioning can occur at compile time, link time, or run time as the program is being loaded and executed. To explore these different mechanisms, we will use the example program in [Figure 7.20\(a\)](#)  as a running example. It calls the `malloc` and `free` functions from the C standard library (`libc.so`). The call to `malloc` allocates a block of 32 bytes from the heap and returns a pointer to the block. The call to `free` gives the block back to the heap, for use by subsequent calls to

`malloc`. Our goal is to use interpositioning to trace the calls to `malloc` and `free` as the program runs.



# 7.13.1 Compile-Time Interpositioning

**Figure 7.20**  shows how to use the C preprocessor to interpose at compile time. Each wrapper function in `mymalloc.c` (**Figure 7.20(c)** ) calls the target function, prints a trace, and returns. The local `malloc.h` header file (**Figure 7.20(b)** ) instructs the preprocessor to replace each call to a target function with a call to its wrapper. Here is how to compile and link the program:

```
linux> gcc -DCOMPLETEIME -c mymalloc.c
linux> gcc -I. -o intc int.c mymalloc.o
```

The interpositioning happens because of the `-I.` argument, which tells the C preprocessor to look for `malloc.h` in the current directory before looking in the usual system directories. Notice that the wrappers in `mymalloc.c` are compiled with the standard `malloc.h` header file.


Running the program gives the following trace:

```
linux> ./intc
```

```
malloc(32)=0x9ee010
```

```
free(0x9ee010)
```

## 7.13.2 Link-Time Interpositioning

The Linux static linker supports link-time interpositioning with the `--wrap f` flag. This flag tells the linker to resolve references to symbol `f` as `__wrap_f` (two underscores for the prefix), and to resolve references to symbol `__real_f` (two underscores for the prefix) as `f`. **Figure 7.21**  shows the wrappers for our example program.

Here is how to compile the source files into relocatable object files:

```
linux> gcc -DLINKTIME -c mymalloc.c
```

```
linux> gcc -c int.c
```

(a) Example program int.c

-----code/link/interpose/int.c

```
|  
1  #include <stdio.h>  
2  #include <malloc.h>  
3  
4  int main()  
5  {  
6      int *p = malloc(32);  
7      free(p);  
8      return(0);  
9  }
```

-----code/link/interpose/int.c

(b) Local malloc.h file

-----code/link/interpose/malloc.h

```
|  
1     #define malloc(size) mymalloc(size)  
2     #define free(ptr) myfree(ptr)  
3  
4     void *mymalloc(size_t size);  
5     void myfree(void *ptr);
```

-----*code/link/interpose/malloc.h*

(c) Wrapper functions in mymalloc.c

-----*code/link/interpose/mymalloc.c*

```

1  #ifdef COMPILETIME
2  #include <stdio.h>
3  #include <malloc.h>
4
5  /* malloc wrapper function */
6  void *mymalloc(size_t size)
7  {
8      void *ptr = malloc(size);
9      printf("malloc(%d)=%pn",
10             (int)size, ptr);
11     return ptr;
12 }
13
14 /* free wrapper function */
15 void myfree(void *ptr)
16 {
17     free(ptr);
18     printf("free(%p)n", ptr);
19 }
20 #endif

```

-----code/link/interpose/mymalloc.c

**Figure 7.20** Compile-time interpositioning with the C preprocessor.

-----code/link/interpose/mymalloc.c

```
|
1  #ifdef LINKTIME
2  #include <stdio.h>
3
4  void *__real_malloc(size_t size);
5  void __real_free(void *ptr);
6
7  /* malloc wrapper function */
8  void *__wrap_malloc(size_t size)
9  {
10     void *ptr = __real_malloc(size); /* Call libc
malloc */
11     printf("malloc(%d) = %pn", (int)size, ptr);
12     return ptr;
13 }
14
15 /* free wrapper function */
16 void __wrap_free(void *ptr)
17 {
18     __real_free(ptr); /* Call libc free */
19     printf("free(%p)n", ptr);
20 }
21 #endif
```

-----code/link/interpose/mymalloc.c

## Figure 7.21 Link-time interpositioning with the `--wrap` flag.

And here is how to link the object files into an executable:

```
linux> gcc -Wl,--wrap,malloc -Wl,--wrap,free -o intl int.o  
mymalloc.o
```

The `-Wl`, option flag passes option to the linker. Each comma in option is replaced with a space. So `-Wl, --wrap, malloc` passes `--wrap malloc` to the linker, and similarly for `-Wl, --wrap, free`.

Running the program gives the following trace:


```
linux> ./intl  
malloc(32) = 0x18cf010  
free(0x18cf010)
```



## 7.13.3 Run-Time Interpositioning

Compile-time interpositioning requires access to a program's source files. Link-time interpositioning requires access to its relocatable object files. However, there is a mechanism for interpositioning at run time that requires access only to the executable object file. This fascinating mechanism is based on the dynamic linker's `LD_PRELOAD` environment variable.

If the `LD_PRELOAD` environment variable is set to a list of shared library pathnames (separated by spaces or colons), then when you load and execute a program, the dynamic linker (`LD-LINUX.SO`) will search the `LD_PRELOAD` libraries first, before any other shared libraries, when it resolves undefined references. With this mechanism, you can interpose on any function in any shared library, including `libc.so`, when you load and execute any executable.

**Figure 7.22**  shows the wrappers for `malloc` and `free`. In each wrapper, the call to `dlsym` returns the pointer to the target `libc` function. The wrapper then calls the target function, prints a trace, and returns.

Here is how to build the shared library that contains the wrapper functions:

```
linux> gcc -DRUNTIME -shared -fpic -o mymalloc.so mymalloc.c -  
ldl
```

Here is how to compile the main program:

```
linux> gcc -o intr int.c
```

Here is how to run the program from the bash shell:<sup>3</sup>

3. If you don't know what shell you are running, type `printenv SHELL` at the command line.

```
linux> LD_PRELOAD="./mymalloc.so" . /intr  
malloc(32) = 0x1bf7010  
free(0x1bf7010)
```

And here is how to run it from the `csch` or `tcsh` shells:

```
linux> (setenv LD_PRELOAD "./mymalloc.so"; . /intr; unsetenv  
LD_PRELOAD)  
malloc(32) = 0x2157010  
free(0x2157010)
```

Notice that you can use `LD_PRELOAD` to interpose on the library calls of *any* executable program!

```
linux> LD_PRELOAD="./mymalloc.so" /usr/bin/uptime
malloc(568) = 0x21bb010
free(0x21bb010)
malloc(15) = 0x21bb010
malloc(568) = 0x21bb030
malloc(2255) = 0x21bb270
free(0x21bb030)
malloc(20) = 0x21bb030
malloc(20) = 0x21bb050
malloc(20) = 0x21bb070
malloc(20) = 0x21bb090
malloc(20) = 0x21bb0b0
malloc(384) = 0x21bb0d0
20:47:36 up 85 days, 6:04, 1 user, load average: 0.10, 0.04,
0.05
```

-----[code/link/interpose/mymalloc.c](#)

```
1     #ifdef RUNTIME
2     #define _GNU_SOURCE
3     #include <stdio.h>
4     #include <stdlib.h>
5     #include <dlfcn.h>
6
7     /* malloc wrapper function */
8     void *malloc(size_t size)
9     {
10         void *(*mallocp)(size_t size);
11         char *error;
12
13         mallocp = dlsym(RTLD_NEXT, "malloc"); /* Get
address of libc malloc */
14         if ((error = dlerror()) != NULL) {
15             fputs(error, stderr);
16             exit(1);
17         }
18         char *ptr = mallocp(size); /* Call libc malloc
*/
19         printf("malloc(%d) = %pn", (int)size, ptr);
20         return ptr;
21     }
22
23     /* free wrapper function */
24     void free(void *ptr)
25     {
```

```

26         void (*freep)(void *) = NULL;
27         char *error;
28
29         if (!ptr)
30             return;
31
32         freep = dlsym(RTLD_NEXT, "free"); /* Get address
of libc free */
33         if ((error = dlerror()) != NULL) {
34             fputs(error, stderr);
35             exit(1);
36         }
37         freep(ptr); /* Call libc free */
38         printf("free(%p)\n", ptr);
39     }
40 #endif

```

-----code/link/interpose/mymalloc.c

Figure 7.22 Run-time interpositioning with `LD_PRELOAD`.

[OceanofPDF.com](http://OceanofPDF.com)

## 7.14 Tools for Manipulating Object Files

There are a number of tools available on Linux systems to help you understand and manipulate object files. In particular, the GNU *binutils* package is especially helpful and runs on every Linux platform.

**AR.** Creates static libraries, and inserts, deletes, lists, and extracts members.

**STRINGS.** Lists all of the printable strings contained in an object file.

**STRIP.** Deletes symbol table information from an object file.

**NM.** Lists the symbols defined in the symbol table of an object file.

**SIZE.** Lists the names and sizes of the sections in an object file.

**READELF.** Displays the complete structure of an object file, including all of the information encoded in the ELF header.

Subsumes the functionality of **SIZE** and **NM**.

**OBJDUMP.** The mother of all binary tools. Can display all of the information in an object file. Its most useful function is disassembling the binary instructions in the `.text` section.

Linux systems also provide the `LDD` program for manipulating shared libraries:

`LDD`: Lists the shared libraries that an executable needs at run time.

[OceanofPDF.com](http://OceanofPDF.com)



## 7.15 Summary

Linking can be performed at compile time by static linkers and at load time and run time by dynamic linkers. Linkers manipulate binary files called object files, which come in three different forms: relocatable, executable, and shared. Relocatable object files are combined by static linkers into an executable object file that can be loaded into memory and executed. Shared object files (shared libraries) are linked and loaded by dynamic linkers at run time, either implicitly when the calling program is loaded and begins executing, or on demand, when the program calls functions from the `dlopen` library.

The two main tasks of linkers are symbol resolution, where each global symbol in an object file is bound to a unique definition, and relocation, where the ultimate memory address for each symbol is determined and where references to those objects are modified.

Static linkers are invoked by compiler drivers such as `gcc`. They combine multiple relocatable object files into a single executable object file. Multiple object files can define the same symbol, and the rules that linkers use for silently resolving these multiple definitions can introduce subtle bugs in user programs.

Multiple object files can be concatenated in a single static library. Linkers use libraries to resolve symbol references in other object

modules. The left-to-right sequential scan that many linkers use to resolve symbol references is another source of confusing link-time errors.

Loaders map the contents of executable files into memory and run the program. Linkers can also produce partially linked executable object files with unresolved references to the routines and data defined in a shared library. At load time, the loader maps the partially linked executable into memory and then calls a dynamic linker, which completes the linking task by loading the shared library and relocating the references in the program.

Shared libraries that are compiled as position-independent code can be loaded anywhere and shared at run time by multiple processes. Applications can also use the dynamic linker at run time in order to load, link, and access the functions and data in shared libraries.

[OceanofPDF.com](http://OceanofPDF.com)

# Bibliographic Notes

Linking is poorly documented in the computer systems literature. Since it lies at the intersection of compilers, computer architecture, and operating systems, linking requires an understanding of code generation, machine-language programming, program instantiation, and virtual memory. It does not fit neatly into any of the usual computer systems specialties and thus is not well covered by the classic texts in these areas. However, Levine's monograph provides a good general reference on the subject [69]. The original IA 32 specifications for ELF and DWARF (a specification for the contents of the `.debug` and `.line` sections) are described in [54]. The x86-64 extensions to the ELF file format are described in [36]. The x86-64 application binary interface (ABI) describes the conventions for compiling, linking, and running x86-64 programs, including the rules for relocation and position-independent code [77].

# Homework Problems

## 7.6 ♦

This problem concerns the `m.o` module from [Figure 7.5](#) and the following version of the `swap.c` function that counts the number of times it has been called:

```

|
1  extern int buf[];
2
3  int *bufp0 = &buf[0];
4  static int *bufp1;
5
6  static void incr()
7  {
8      static int count=0;
9
10     count++;
11 }
12
13 void swap()
14 {
15     int temp;
16
17     incr();
18     bufp1 = &buf[1];
19     temp = *bufp0;
20     *bufp0 = *bufp1;
21     *bufp1 = temp;
22 }

```

For each symbol that is defined and referenced in `swap.o`, indicate if it will have a symbol table entry in the `.symtab` section in module `swap.o`. If so, indicate the module that defines the symbol (`swap.o` or

`m.o`), the symbol type(local, global, or extern), and the section (`.text`, `.data`, or `.bss`) it occupies in that module.

## 7.7 ♦

Without changing any variable names, modify `bar5.c` on page 683 so that `foo5.c` prints the correct values of `x` and `y` (i.e., the hex representations of integers 15213 and 15212).

## 7.8 ♦

In this problem, let  $\text{REF}(x.i) \rightarrow \text{DEF}(x.k)$  denote that the linker will associate an arbitrary reference to symbol  $x$  in module  $i$  to the definition of  $x$  in module  $k$ . For each example below, use this notation to indicate how the linker would resolve references to the multiply-defined symbol in each module. If there is a link-time error (rule 1), write "ERROR". If the linker arbitrarily chooses one of the definitions (rule 3), write "UNKNOWN".

A.

```
|
/* Module 1 */          /* Module 2 */
int main()              static int main=1[
{                        int p2()
}                        {
                        }
(a) REF(main.1) → DEF(____.____)
(b) REF(main.2) → DEF(____.____)
```

B.



```

|
/* Module 1 */          /* Module 2 */
int x;                  double x;
void main()            int p2()
{                      {
}                      }

```

(a) REF(x.1) → DEF(\_\_\_\_.\_\_\_\_)

(b) REF(x.2) → DEF(\_\_\_\_.\_\_\_\_)

C.

```

|
/* Module 1 */          /* Module 2 */
int x=1;                double x=1.0;
void main()            int p2()
{                      {
}                      }

```

(a) REF(x.1) → DEF(\_\_\_\_.\_\_\_\_)

(b) REF(x.2) → DEF(\_\_\_\_.\_\_\_\_)

## 7.9 ♦

Consider the following program, which consists of two object modules:

```
|  
1      /* foo6.c */  
2      void p2(void);  
3  
4      int main()  
5      {  
6          p2();  
7          return 0;  
8      }
```

```
1  /* bar6.c */
2  #include <stdio.h>
3
4  char main;
5
6  void p2()
7  {
8      printf("0x%x\n", main);
9  }
```

When this program is compiled and executed on an x86-64 Linux system, it prints the string `0x48\n` and terminates normally, even though function `p2` never initializes variable `main`. Can you explain this?

## 7.10 ♦♦

Let `a` and `b` denote object modules or static libraries in the current directory, and let `a → b` denote that `a` depends on `b`, in the sense that `b` defines a symbol that is referenced by `a`. For each of the following scenarios, show the minimal command line (i.e., one with the least number of object file and library arguments) that will allow the static linker to resolve all symbol references:

A. `p.o → libx.a → p.o`

B. `p.o → libx.a → liby.a and liby.a → libx.a`

C. `p.o → libx.a → liby.a → libz.a and liby.a → libx.a → libz.a`

## 7.11 ♦♦

The program header in [Figure 7.14](#) indicates that the data segment occupies `0x230` bytes in memory. However, only the first `0x228` bytes of these come from the sections of the executable file. What causes this discrepancy?

## 7.12 ♦♦

Consider the call to function `swap` in object file `m.o` ([Problem 7.6](#)).

```
9: e8 00 00 00 00      callq e <main+0xe>      swap()
```

with the following relocation entry:

```
r.offset = 0xa
r.symbol = swap
r.type = R_X86_64_PC32
r.addend = -4
```

- A. Suppose that the linker relocates `.text` in `m.o` to address `0x4004e0` and `swap` to address `0x4004f8`. Then what is the value of the relocated reference to `swap` in the `callq` instruction?
- B. Suppose that the linker relocates `.text` in `m.o` to address `0x4004d0` and `swap` to address `0x400500`. Then what is the value of the relocated reference to `swap` in the `callq` instruction?

## 7.13 ♦♦

Performing the following tasks will help you become more familiar with the various tools for manipulating object files.

- A. How many object files are contained in the versions of `libc.a` and `libm.a` on your system?
- B. Does `gcc -Og` produce different executable code than `gcc -Og -g`?
- C. What shared libraries does the `gcc` driver on your system use?

[OceanofPDF.com](http://OceanofPDF.com)

# Solutions to Practice Problems

## Solution to Problem 7.1 [↗](#)(page 678)

The purpose of this problem is to help you understand the relationship between linker symbols and C variables and functions. Notice that the C local variable `temp` does *not* have a symbol table entry.



# Solution to Problem 7.2 (page 684)

This is a simple drill that checks your understanding of the rules that a Unix linker uses when it resolves global symbols that are defined in more than one module. Understanding these rules can help you avoid some nasty programming bugs.

A. The linker chooses the strong symbol defined in module 1 over the weak symbol defined in module 2 (rule 2):

a. `REF(main.1) → DEF(main.1)`

b. `REF(main.2) → DEF(main.1)`

B. This is an `ERROR`, because each module defines a strong symbol `main` (rule 1).

C. The linker chooses the strong symbol defined in module 2 over the weak symbol defined in module 1 (rule 2):

a. `REF(x.1) → DEF(x.2)`

b. `REF(x.2) → DEF(x.2)`

## Solution to Problem 7.3 (page 689)

Placing static libraries in the wrong order on the command line is a common source of linker errors that confuses many programmers. However, once you understand how linkers use static libraries to resolve references, it's pretty straightforward. This little drill checks your understanding of this idea:

- A. `linux> gcc p.o libx.a`
- B. `linux> gcc p.o libx.a liby.a`
- C. `linux> gcc p.o libx.a liby.a libx.a`

# Solution to Problem 7.4 (page 694)

This problem concerns the disassembly listing in [Figure 7.12\(a\)](#). Our purpose here is to give you some practice reading disassembly listings and to check your understanding of PC-relative addressing.

A. The hex address of the relocated reference in line 5 is

`0x4004df`.

B. The hex value of the relocated reference in line 5 is `0x5`.

Remember that the disassembly listing shows the value of the reference in little-endian byte order.

# Solution to Problem 7.5 [↗](#)(page 695)

This problem tests your understanding of how the linker relocates PC-relative references. You were given that

```
ADDR(s) = ADDR(.text) = 0x4004d0
```

and

```
ADDR(r.symbol) = ADDR(swap) = 0x4004e8
```

Using the algorithm in [Figure 7.10](#) [↗](#), the linker first computes the run-time address of the reference:

```
refaddr = ADDR(s) + r.offset  
= 0x4004d0 + 0xa  
= 0x4004da
```

It then updates the reference:

```
*refptr = (unsigned) (ADDR(r.symbol) + r.addend - refaddr)
= (unsigned) (0x4004e8 + (-4) - 0x4004da)
= (unsigned) (0xa)
```

Thus, in the resulting executable object file, the PC-relative reference to `swap` has a value of `0xa`:

```
4004d9: e8 0a 00 00 00 callq 4004e8 <swap>
```

[OceanofPDF.com](http://OceanofPDF.com)

---

# Chapter 8 Exceptional Control Flow

---

**8.1 Exceptions 723** 

**8.2 Processes 732** 

**8.3 System Call Error Handling 737** 

**8.4 Process Control 738** 

**8.5 Signals 756** 

**8.6 Nonlocal Jumps 781** 

**8.7 Tools for Manipulating Processes 786** 

**8.8 Summary 787** 

**Bibliographic Notes 787** 

**Homework Problems 788** 

**Solutions to Practice Problems 795** 

*From the time you first apply power to a processor until the time you shut it off, the program counter assumes a sequence of values*

$$a_0, a_1, \dots, a_{n-1}$$

*where each  $a_k$  is the address of some corresponding instruction  $I_k$ . Each transition from  $a_k$  to  $a_{k+1}$  is called a control transfer. A sequence of such control transfers is called the flow of control, or control flow, of the processor.*

*The simplest kind of control flow is a “smooth” sequence where each  $I_k$  and  $I_{k+1}$  are adjacent in memory. Typically, abrupt changes to this smooth flow, where  $I_{k+1}$  is not adjacent to  $I_k$ , are caused by familiar program instructions such as jumps, calls, and returns. Such instructions are necessary mechanisms that allow programs to react to changes in internal program state represented by program variables.*

*But systems must also be able to react to changes in system state that are not captured by internal program variables and are not necessarily related to the execution of the*




*program. For example, a hardware timer goes off at regular intervals and must be dealt with. Packets arrive at the network adapter and must be stored in memory. Programs request data from a disk and then sleep until they are notified that the data are ready. Parent processes that create child processes must be notified when their children terminate.*

*Modern systems react to these situations by making abrupt changes in the control flow. In general, we refer to these abrupt changes as exceptional control flow (ECF). ECF occurs at all levels of a computer system. For example, at the hardware level, events detected by the hardware trigger abrupt control transfers to exception handlers. At the operating systems level, the kernel transfers control from one user process to another via context switches. At the application level, a process can send a signal to another process that abruptly transfers control to a signal handler in the recipient. An individual program can react to errors by sidestepping the usual stack discipline and making nonlocal jumps to arbitrary locations in other functions.*

*As programmers, there are a number of reasons why it is important for you to understand ECF:*

- ***Understanding ECF will help you understand important systems concepts.*** *ECF is the basic mechanism that operating systems use to implement I/O, processes, and virtual memory. Before you can really understand these important ideas, you need to understand ECF.*
- ***Understanding ECF will help you understand how applications interact with the operating system.*** *Applications request services from the operating system by using a form of ECF known as a trap or system call. For example, writing data to a disk, reading data from a network, creating a new process, and terminating the current process are all accomplished by application programs invoking system calls. Understanding the basic system call mechanism will help you understand how these services are provided to applications.*
- ***Understanding ECF will help you write interesting new application programs.*** *The operating system provides application programs with powerful ECF mechanisms for creating new processes, waiting for*

processes to terminate, notifying other processes of exceptional events in the system, and detecting and responding to these events. If you understand these ECF mechanisms, then you can use them to write interesting programs such as Unix shells and Web servers.

- **Understanding ECF will help you understand concurrency.** ECF is a basic mechanism for implementing concurrency in computer systems. The following are all examples of concurrency in action: an exception handler that interrupts the execution of an application program; processes and threads whose execution overlap in time; and a signal handler that interrupts the execution of an application program. Understanding ECF is a first step to understanding concurrency. We will return to study it in more detail in [Chapter 12](#) .
- **Understanding ECF will help you understand how software exceptions work.** Languages such as C++ and Java provide software exception mechanisms via `try`, `catch`, and `throw` statements. Software exceptions allow the program to make nonlocal jumps (i.e., jumps that violate the usual call/return stack discipline) in response


to error conditions. Nonlocal jumps are a form of application-level ECF and are provided in C via the `setjmp` and `longjmp` functions. Understanding these low-level functions will help you understand how higher-level software exceptions can be implemented.

Up to this point in your study of systems, you have learned how applications interact with the hardware. This chapter is pivotal in the sense that you will begin to learn how your applications interact with the operating system. Interestingly, these interactions all revolve around ECF. We describe the various forms of ECF that exist at all levels of a computer system. We start with exceptions, which lie at the intersection of the hardware and the operating system. We also discuss system calls, which are exceptions that provide applications with entry points into the operating system. We then move up a level of abstraction and describe processes and signals, which lie at the intersection of applications and the operating system. Finally, we discuss nonlocal jumps, which are an application-level form of ECF.

[OceanofPDF.com](http://OceanofPDF.com)

# 8.1 Exceptions

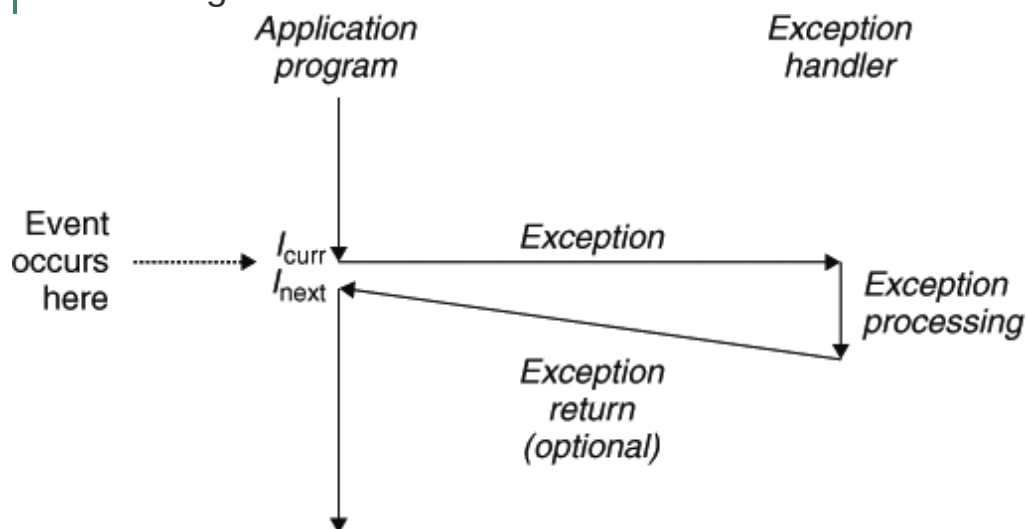
Exceptions are a form of exceptional control flow that are implemented partly by the hardware and partly by the operating system. Because they are partly implemented in hardware, the details vary from system to system. However, the basic ideas are the same for every system. Our aim in this section is to give you a general understanding of exceptions and exception handling and to help demystify what is often a confusing aspect of modern computer systems.

An *exception* is an abrupt change in the control flow in response to some change in the processor's state. [Figure 8.1](#)  shows the basic idea.

In the figure, the processor is executing some current instruction  $I_{\text{curr}}$  when a significant change in the processor's *state* occurs. The state is encoded in various bits and signals inside the processor. The change in state is known as an *event*.

# Aside Hardware versus software exceptions

C++ and Java programmers will have noticed that the term “exception” is also used to describe the application-level ECF mechanism provided by C++ and Java in the form of `catch`, `throw`, and `try` statements. If we wanted to be perfectly clear, we might distinguish between “hardware” and “software” exceptions, but this is usually unnecessary because the meaning is clear from the context.



**Figure 8.1 Anatomy of an exception.**

A change in the processor's state (an event) triggers an abrupt control transfer (an exception) from the application program to an exception handler. After it finishes processing, the handler either returns control to the interrupted program or aborts.

The event might be directly related to the execution of the current instruction. For example, a virtual memory page fault occurs, an

arithmetic overflow occurs, or an instruction attempts a divide by zero. On the other hand, the event might be unrelated to the execution of the current instruction. For example, a system timer goes off or an I/O request completes.

In any case, when the processor detects that the event has occurred, it makes an indirect procedure call (the exception), through a jump table called an *exception table*, to an operating system subroutine (the *exception handler*) that is specifically designed to process this particular kind of event. When the exception handler finishes processing, one of three things happens, depending on the type of event that caused the exception:

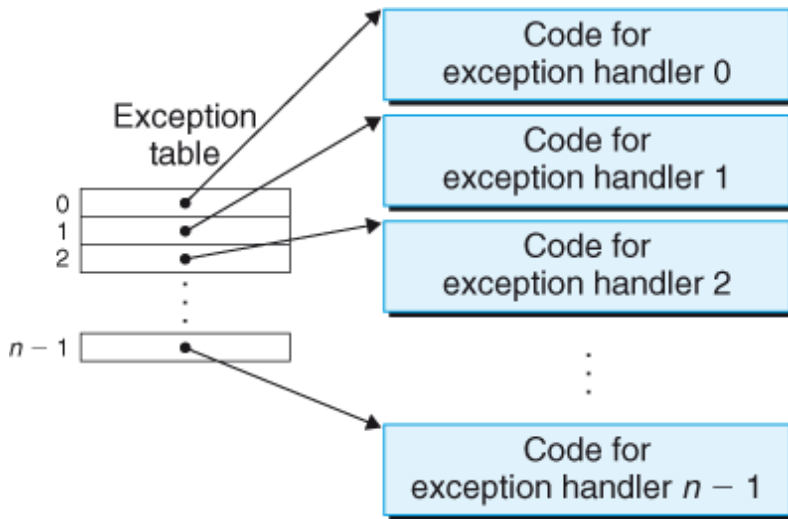
1. The handler returns control to the current instruction  $I_{curr}$ , the instruction that was executing when the event occurred.
2. The handler returns control to  $I_{next}$ , the instruction that would have executed next had the exception not occurred.
3. The handler aborts the interrupted program.

**Section 8.1.2**  says more about these possibilities.



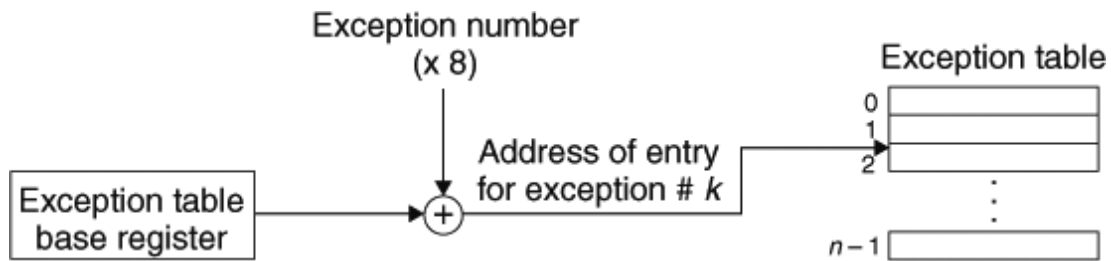
# 8.1.1 Exception Handling

Exceptions can be difficult to understand because handling them involves close cooperation between hardware and software. It is easy to get confused about



**Figure 8.2 Exception table.**

The exception table is a jump table where entry  $k$  contains the address of the handler code for exception  $k$ .





**Figure 8.3 Generating the address of an exception handler.**

The exception number is an index into the exception table.

which component performs which task. Let's look at the division of labor between hardware and software in more detail.

Each type of possible exception in a system is assigned a unique nonnegative integer *exception number*. Some of these numbers are assigned by the designers of the processor. Other numbers are assigned by the designers of the operating system *kernel* (the memory-resident part of the operating system). Examples of the former include divide by zero, page faults, memory access violations, breakpoints, and arithmetic overflows. Examples of the latter include system calls and signals from external I/O devices.

At system boot time (when the computer is reset or powered on), the operating system allocates and initializes a jump table called an *exception table*, so that entry  $k$  contains the address of the handler for exception  $k$ . **Figure 8.2**  shows the format of an exception table.

At run time (when the system is executing some program), the processor detects that an event has occurred and determines the corresponding exception number  $k$ . The processor then triggers the exception by making an indirect procedure call, through entry  $k$  of the exception table, to the corresponding handler. **Figure 8.3**  shows how the processor uses the exception table to form the address of the appropriate exception handler. The exception number is an index into the exception table, whose starting address is contained in a special CPU register called the *exception table base register*.

An exception is akin to a procedure call, but with some important differences:

- As with a procedure call, the processor pushes a return address on the stack before branching to the handler. However, depending on the class of exception, the return address is either the current instruction (the instruction that was executing when the event occurred) or the next instruction (the instruction that would have executed after the current instruction had the event not occurred).
- The processor also pushes some additional processor state onto the stack that will be necessary to restart the interrupted program when the handler returns. For example, an x86-64 system pushes the EFLAGS register containing the current condition codes, among other things, onto the stack.
- When control is being transferred from a user program to the kernel, all of these items are pushed onto the kernel's stack rather than onto the user's stack.
- Exception handlers run in *kernel mode* ([Section 8.2.4](#)), which means they have complete access to all system resources.


Once the hardware triggers the exception, the rest of the work is done in software by the exception handler. After the handler has processed the event, it optionally returns to the interrupted program by executing a special “return from interrupt” instruction, which pops the appropriate state back into the processor's control and data registers, restores the state to *user mode* ([Section 8.2.4](#)) if the exception interrupted a user program, and then returns control to the interrupted program.

## 8.1.2 Classes of Exceptions

Exceptions can be divided into four classes: *interrupts*, *traps*, *faults*, and *aborts*. The table in [Figure 8.4](#) summarizes the attributes of these classes.

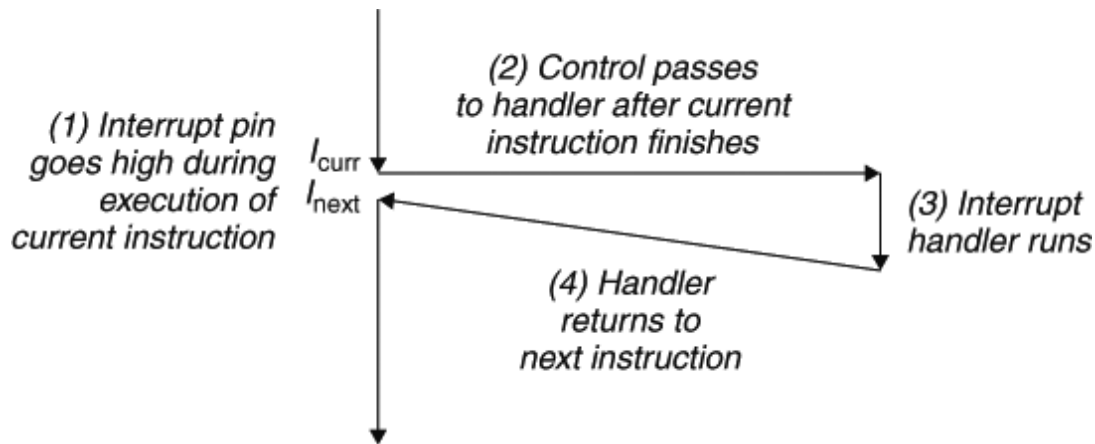
# *Interrupts*

*Interrupts* occur *asynchronously* as a result of signals from I/O devices that are external to the processor. Hardware interrupts are asynchronous in the sense that they are not caused by the execution of any particular instruction. Exception handlers for hardware interrupts are often called *interrupt handlers*.

**Figure 8.5**  summarizes the processing for an interrupt. I/O devices such as network adapters, disk controllers, and timer chips trigger interrupts by signaling a pin on the processor chip and placing onto the system bus the exception number that identifies the device that caused the interrupt.

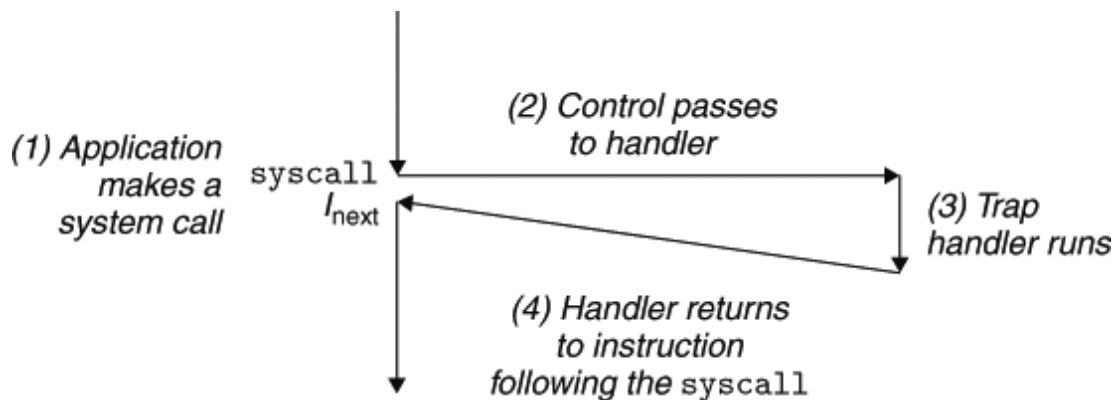
## **Figure 8.4 Classes of exceptions.**

Asynchronous exceptions occur as a result of events in I/O devices that are external to the processor. Synchronous exceptions occur as a direct result of executing an instruction.



**Figure 8.5 Interrupt handling.**

The interrupt handler returns control to the next instruction in the application program's control flow.



**Figure 8.6 Trap handling.**

The trap handler returns control to the next instruction in the application program's control flow.


After the current instruction finishes executing, the processor notices that the interrupt pin has gone high, reads the exception number from the system bus, and then calls the appropriate interrupt handler. When the handler returns, it returns control to the next instruction (i.e., the instruction that would have followed the current instruction in

the control flow had the interrupt not occurred). The effect is that the program continues executing as though the interrupt had never happened.

The remaining classes of exceptions (traps, faults, and aborts) occur *synchronously* as a result of executing the current instruction. We refer to this instruction as the *faulting instruction*.

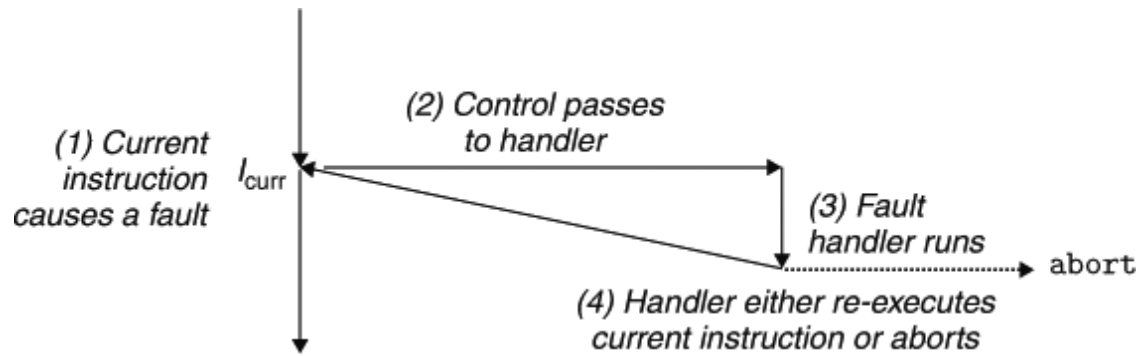
## *Traps and System Calls*

*Traps* are *intentional* exceptions that occur as a result of executing an instruction. Like interrupt handlers, trap handlers return control to the next instruction. The most important use of traps is to provide a procedure-like interface between user programs and the kernel, known as a *system call*.

User programs often need to request services from the kernel such as reading a file (`read`), creating a new process (`fork`), loading a new program (`execve`), and terminating the current process (`exit`). To allow controlled access to such kernel services, processors provide a special `syscall n` instruction that user programs can execute when they want to request service  $n$ . Executing the `syscall` instruction causes a trap to an exception handler that decodes the argument and calls the appropriate kernel routine. **Figure 8.6**  summarizes the processing for a system call.

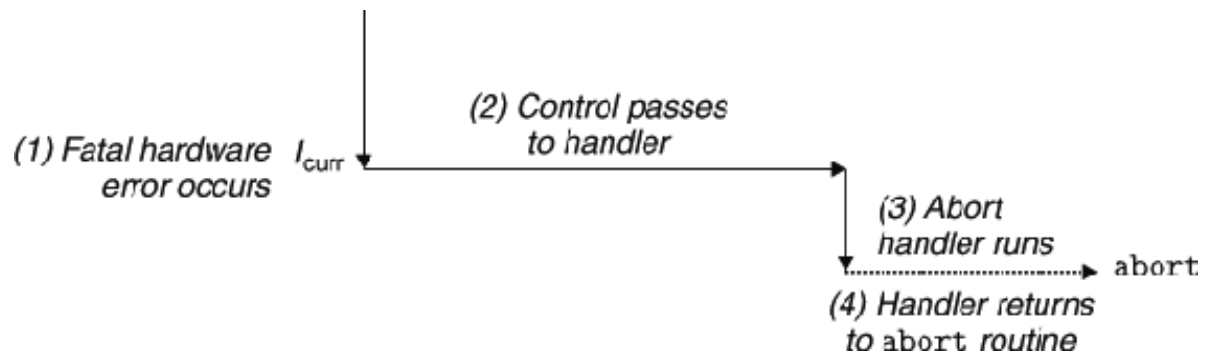
From a programmer's perspective, a system call is identical to a regular function call. However, their implementations are quite different. Regular functions





**Figure 8.7 Fault handling.**

Depending on whether the fault can be repaired or not, the fault handler either re-executes the faulting instruction or aborts.





**Figure 8.8 Abort handling.**

The abort handler passes control to a kernel `abort` routine that terminates the application program.

run in *user mode*, which restricts the types of instructions they can execute, and they access the same stack as the calling function. A system call runs in *kernel mode*, which allows it to execute privileged instructions and access a stack defined in the kernel. [Section 8.2.4](#) discusses user and kernel modes in more detail.

# *Faults*

Faults result from error conditions that a handler might be able to correct. When a fault occurs, the processor transfers control to the fault handler. If the handler is able to correct the error condition, it returns control to the faulting instruction, thereby re-executing it. Otherwise, the handler returns to an `abort` routine in the kernel that terminates the application program that caused the fault. [Figure 8.7](#)  summarizes the processing for a fault.


A classic example of a fault is the page fault exception, which occurs when an instruction references a virtual address whose corresponding page is not resident in memory and must therefore be retrieved from disk. As we will see in [Chapter 9](#) , a page is a contiguous block (typically 4 KB) of virtual memory. The page fault handler loads the appropriate page from disk and then returns control to the instruction that caused the fault. When the instruction executes again, the appropriate page is now resident in memory and the instruction is able to run to completion without faulting.

# *Aborts*

Aborts result from unrecoverable fatal errors, typically hardware errors such as parity errors that occur when DRAM or SRAM bits are corrupted. Abort handlers never return control to the application program. As shown in [Figure 8.8](#), the handler returns control to an `abort` routine that terminates the application program.

**Figure 8.9 Examples of exceptions in x86-64 systems.**


## 8.1.3 Exceptions in Linux/x86-64 Systems

To help make things more concrete, let's look at some of the exceptions defined for x86-64 systems. There are up to 256 different exception types [50]. Numbers in the range from 0 to 31 correspond to exceptions that are defined by the Intel architects and thus are identical for any x86-64 system. Numbers in the range from 32 to 255 correspond to interrupts and traps that are defined by the operating system. **Figure 8.9**  shows a few examples.

# *Linux/x86-64 Faults and Aborts*

**Divide error.** A divide error (exception 0) occurs when an application attempts to divide by zero or when the result of a divide instruction is too big for the destination operand. Unix does not attempt to recover from divide errors, opting instead to abort the program. Linux shells typically report divide errors as “Floating exceptions.”

**General protection fault.** The infamous general protection fault (exception 13) occurs for many reasons, usually because a program references an undefined area of virtual memory or because the program attempts to write to a read-only text segment. Linux does not attempt to recover from this fault. Linux shells typically report general protection faults as “Segmentation faults.”


**Page fault.** A page fault (exception 14) is an example of an exception where the faulting instruction is restarted. The handler maps the appropriate page of virtual memory on disk into a page of physical memory and then restarts the faulting instruction. We will see how page faults work in detail in [Chapter 9](#) .

**Machine check.** A machine check (exception 18) occurs as a result of a fatal hardware error that is detected during the execution of the faulting instruction. Machine check handlers never return control to the application program.

# Linux/x86-64 System Calls

Linux provides hundreds of system calls that application programs use when they want to request services from the kernel, such as reading a file, writing a file, and

**Figure 8.10 Examples of popular system calls in Linux x86-64 systems.**

creating a new process. **Figure 8.10**  lists some popular Linux system calls. Each system call has a unique integer number that corresponds to an offset in a jump table in the kernel. (Notice that this jump table is not the same as the exception table.)

C programs can invoke any system call directly by using the `syscall` function. However, this is rarely necessary in practice. The C standard library provides a set of convenient wrapper functions for most system calls. The wrapper functions package up the arguments, trap to the kernel with the appropriate system call instruction, and then pass the return status of the system call back to the calling program. Throughout this text, we will refer to system calls and their associated wrapper functions interchangeably as *system-level functions*.

System calls are provided on x86-64 systems via a trapping instruction called `syscall`. It is quite interesting to study how programs can use this instruction to invoke Linux system calls directly. All arguments to Linux system calls are passed through

general-purpose registers rather than the stack. By convention, register `%rax` contains the syscall number, with up to six arguments in `%rdi`, `%rsi`, `%rdx`, `%r10`, `%r8`, and `%r9`. The first argument is in `%rdi`, the second in `%rsi`, and so on. On return from the system call, registers `%rcx` and `%r11` are destroyed, and `%rax` contains the return value. A negative return value between -4,095 and -1 indicates an error corresponding to negative `errno`.

For example, consider the following version of the familiar `hello` program, written using the `write` system-level function ([Section 10.4](#)) instead of `printf`:

```
|  
1 int main()  
2 {  
3     write(1, "hello, world\n", 13);  
4     _exit(0);  
5 }
```

The first argument to `write` sends the output to `stdout`. The second argument is the sequence of bytes to write, and the third argument gives the number of bytes to write.

## Aside A note on terminology

The terminology for the various classes of exceptions varies from system to system. Processor ISA specifications often distinguish between asynchronous “interrupts” and synchronous “exceptions” yet provide no umbrella term to refer to these very similar concepts. To avoid having to constantly refer to “exceptions and interrupts” and “exceptions or interrupts,” we use the word “exception” as the general term and distinguish between asynchronous exceptions (interrupts) and synchronous exceptions (traps, faults, and aborts) only when it is appropriate. As we have noted, the basic ideas are the same for every system, but you should be aware that some manufacturers' manuals use the word “exception” to refer only to those changes in control flow caused by synchronous events.



---


-----code/ecf/hello-asm64.sa

```
|
1      .section .data
2      string:
3          .ascii "hello, world\n"
4      string_end:
5          .equ len, string_end - string
6      .section .text
7      .globl main
8      main:
First, call write(1, "hello, world\n", 13)
9          movq $1, %rax          write is system call 1
10         movq $1, %rdi         Arg1: stdout has
descriptor 1
11         movq $string, %rsi    Arg2: hello world string
12         movq $len, %rdx      Arg3: string length
13         syscall             Make the system call
Next, call _exit(0)
14         movq $60, %rax       _exit is system call 60
15         movq $0, %rdi        Arg1: exit status is 0
16         syscall             Make the system call
```

---

-----code/ecf/hello-asm64.sa

**Figure 8.11** Implementing the `hello` program directly with Linux system calls.

**Figure 8.11**  shows an assembly-language version of `hello` that uses the `syscall` instruction to invoke the `write` and `exit` system calls directly. Lines 9-13 invoke the `write` function. First, line 9 stores the number of the `write` system call in `%rax`, and lines 10-12 set up the argument list. Then, line 13 uses the `syscall` instruction to invoke the system call. Similarly, lines 14-16 invoke the `_exit` system call.

[OceanofPDF.com](http://OceanofPDF.com)

## 8.2 Processes

Exceptions are the basic building blocks that allow the operating system kernel to provide the notion of a *process*, one of the most profound and successful ideas in computer science.

When we run a program on a modern system, we are presented with the illusion that our program is the only one currently running in the system. Our program appears to have exclusive use of both the processor and the memory. The processor appears to execute the instructions in our program, one after the other, without interruption. Finally, the code and data of our program appear to be the only objects in the system's memory. These illusions are provided to us by the notion of a process.

The classic definition of a process is *an instance of a program in execution*. Each program in the system runs in the *context* of some process. The context consists of the state that the program needs to run correctly. This state includes the program's code and data stored in memory, its stack, the contents of its general purpose registers, its program counter, environment variables, and the set of open file descriptors.

Each time a user runs a program by typing the name of an executable object file to the shell, the shell creates a new process and then runs the executable object file in the context of this new

process. Application programs can also create new processes and run either their own code or other applications in the context of the new process.


A detailed discussion of how operating systems implement processes is beyond our scope. Instead, we will focus on the key abstractions that a process provides to the application:

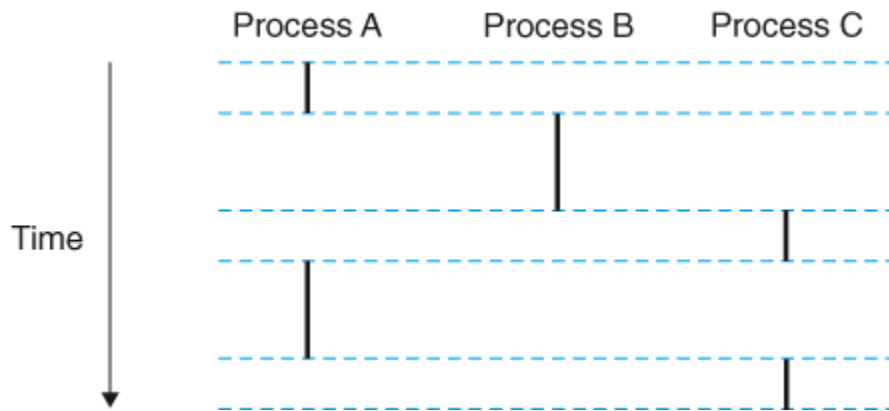
- An independent logical control flow that provides the illusion that our program has exclusive use of the processor.
- A private address space that provides the illusion that our program has exclusive use of the memory system.

Let's look more closely at these abstractions.

## 8.2.1 Logical Control Flow

A process provides each program with the illusion that it has exclusive use of the processor, even though many other programs are typically running concurrently on the system. If we were to use a debugger to single-step the execution of our program, we would observe a series of program counter (PC) values that corresponded exclusively to instructions contained in our program's executable object file or in shared objects linked into our program dynamically at run time. This sequence of PC values is known as a *logical control flow*, or simply *logical flow*.

Consider a system that runs three processes, as shown in [Figure 8.12](#) . The single physical control flow of the processor is partitioned into three logical flows, one for each process. Each vertical line represents a portion of the logical flow for



**Figure 8.12 Logical control flows.**

Processes provide each program with the illusion that it has exclusive use of the processor. Each vertical bar represents a portion of the logical control flow for a process.


a process. In the example, the execution of the three logical flows is interleaved. Process A runs for a while, followed by B, which runs to completion. Process C then runs for a while, followed by A, which runs to completion. Finally, C is able to run to completion.


The key point in [Figure 8.12](#) is that processes take turns using the processor. Each process executes a portion of its flow and then is *preempted* (temporarily suspended) while other processes take their turns. To a program running in the context of one of these processes, it appears to have exclusive use of the processor. The only evidence to the contrary is that if we were to precisely measure the elapsed time of each instruction, we would notice that the CPU appears to periodically stall between the execution of some of the instructions in our program. However, each time the processor stalls, it subsequently resumes execution of our program without any

change to the contents of the program's memory locations or registers.

## 8.2.2 Concurrent Flows

Logical flows take many different forms in computer systems. Exception handlers, processes, signal handlers, threads, and Java processes are all examples of logical flows.

A logical flow whose execution overlaps in time with another flow is called a *concurrent flow*, and the two flows are said to *run concurrently*. More precisely, flows X and Y are concurrent with respect to each other if and only if X begins after Y begins and before Y finishes, or Y begins after X begins and before X finishes. For example, in [Figure 8.12](#) , processes A and B run concurrently, as do A and C. On the other hand, B and C do not run concurrently, because the last instruction of B executes before the first instruction of C.

The general phenomenon of multiple flows executing concurrently is known as *concurrency*. The notion of a process taking turns with other processes is also known as *multitasking*. Each time period that a process executes a portion of its flow is called a *time slice*. Thus, multitasking is also referred to as *time slicing*. For example, in [Figure 8.12](#) , the flow for process A consists of two time slices.

Notice that the idea of concurrent flows is independent of the number of processor cores or computers that the flows are running on. If two flows overlap in time, then they are concurrent, even if they are running on the same processor. However, we will sometimes find it



useful to identify a proper subset of concurrent flows known as *parallel flows*. If two flows are running concurrently on different processor cores or computers, then we say that they are *parallel flows*, that they are *running in parallel*, and have *parallel execution*.


## *Practice Problem 8.1 (solution page **795**)*

Consider three processes with the following starting and ending times:

For each pair of processes, indicate whether they run concurrently (Y) or not (N):

## 8.2.3 Private Address Space

A process provides each program with the illusion that it has exclusive use of the system's address space. On a machine with  $n$ -bit addresses, the *address space* is the set of  $2^n$  possible addresses,  $0, 1, \dots, 2^n - 1$ . A process provides each program with its own *private address space*. This space is private in the sense that a byte of memory associated with a particular address in the space cannot in general be read or written by any other process.

Although the contents of the memory associated with each private address space is different in general, each such space has the same general organization. For example, [Figure 8.13](#)  shows the organization of the address space for an x86-64 Linux process.

The bottom portion of the address space is reserved for the user program, with the usual code, data, heap, and stack segments. The code segment always begins at address `0x400000`. The top portion of the address space is reserved for the kernel (the memory-resident part of the operating system). This part of the address space contains the code, data, and stack that the kernel uses when it executes instructions on behalf of the process (e.g., when the application program executes a system call).

## 8.2.4 User and Kernel Modes

In order for the operating system kernel to provide an airtight process abstraction, the processor must provide a mechanism that restricts the instructions that an

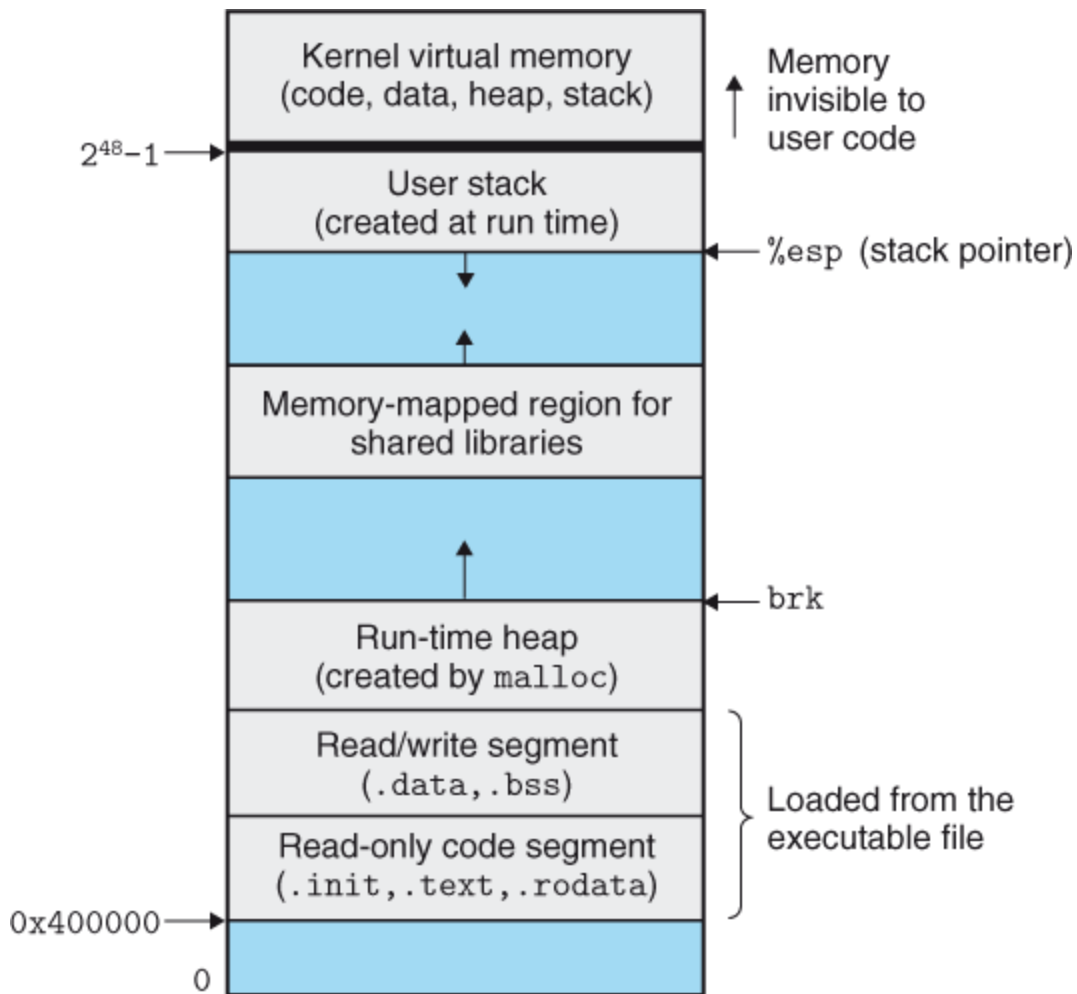


Figure 8.13 Process address space.

application can execute, as well as the portions of the address space that it can access.

Processors typically provide this capability with a *mode bit* in some control register that characterizes the privileges that the process currently enjoys. When the mode bit is set, the process is running in *kernel mode* (sometimes called *supervisor mode*). A process running in kernel mode can execute any instruction in the instruction set and access any memory location in the system.


When the mode bit is not set, the process is running in *user mode*. A process in user mode is not allowed to execute *privileged instructions* that do things such as halt the processor, change the mode bit, or initiate an I/O operation. Nor is it allowed to directly reference code or data in the kernel area of the address space. Any such attempt results in a fatal protection fault. User programs must instead access kernel code and data indirectly via the system call interface.

A process running application code is initially in user mode. The only way for the process to change from user mode to kernel mode is via an exception such as an interrupt, a fault, or a trapping system call. When the exception occurs, and control passes to the exception handler, the processor changes the mode from user mode to kernel mode. The handler runs in kernel mode. When it returns to the application code, the processor changes the mode from kernel mode back to user mode.

Linux provides a clever mechanism, called the `/proc` filesystem, that allows user mode processes to access the contents of kernel data structures. The `/proc` filesystem exports the contents of many kernel

data structures as a hierarchy of text files that can be read by user programs. For example, you can use the `/proc` filesystem to find out general system attributes such as CPU type (`/proc/cpuinfo`), or the memory segments used by a particular process (`/proc/process-id/maps`). The 2.6 version of the Linux kernel introduced a `/sys` filesystem, which exports additional low-level information about system buses and devices.

## 8.2.5 Context Switches

The operating system kernel implements multitasking using a higher-level form of exceptional control flow known as a *context switch*. The context switch mechanism is built on top of the lower-level exception mechanism that we discussed in [Section 8.1](#) .


The kernel maintains a *context* for each process. The context is the state that the kernel needs to restart a preempted process. It consists of the values of objects such as the general-purpose registers, the floating-point registers, the program counter, user's stack, status registers, kernel's stack, and various kernel data structures such as a *page table* that characterizes the address space, a *process table* that contains information about the current process, and a *file table* that contains information about the files that the process has opened.

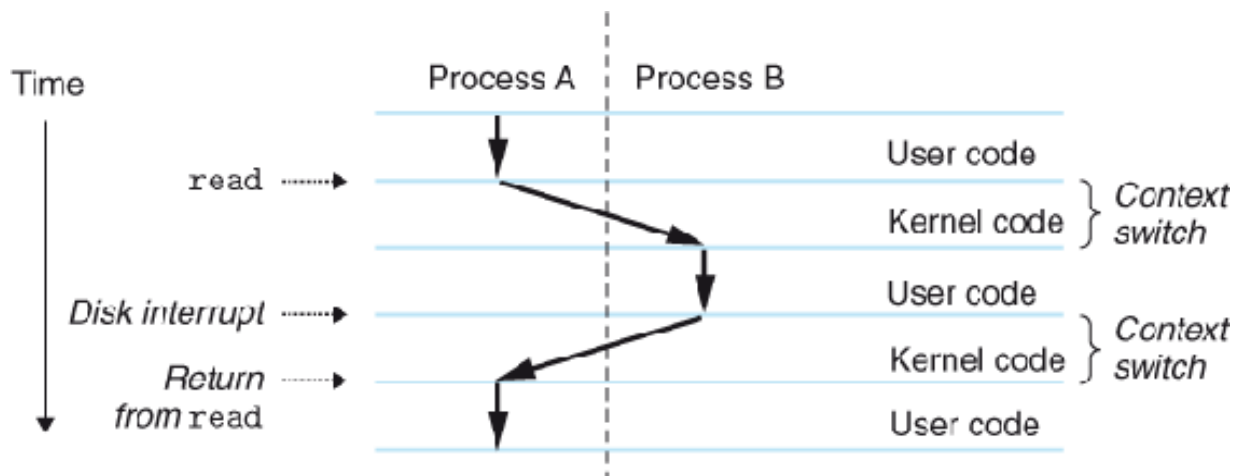
At certain points during the execution of a process, the kernel can decide to preempt the current process and restart a previously preempted process. This decision is known as *scheduling* and is handled by code in the kernel, called the *scheduler*. When the kernel selects a new process to run, we say that the kernel has *scheduled* that process. After the kernel has scheduled a new process to run, it preempts the current process and transfers control to the new process using a mechanism called a *context switch* that (1) saves the context of the current process, (2) restores the saved context of

some previously preempted process, and (3) passes control to this newly restored process.

A context switch can occur while the kernel is executing a system call on behalf of the user. If the system call blocks because it is waiting for some event to occur, then the kernel can put the current process to sleep and switch to another process. For example, if a `read` system call requires a disk access, the kernel can opt to perform a context switch and run another process instead of waiting for the data to arrive from the disk. Another example is the `sleep` system call, which is an explicit request to put the calling process to sleep. In general, even if a system call does not block, the kernel can decide to perform a context switch rather than return control to the calling process.

A context switch can also occur as a result of an interrupt. For example, all systems have some mechanism for generating periodic timer interrupts, typically every 1 ms or 10 ms. Each time a timer interrupt occurs, the kernel can decide that the current process has run long enough and switch to a new process.

**Figure 8.13**  shows an example of context switching between a pair of processes A and B. In this example, initially process A is running in user mode until it traps to the kernel by executing a `read` system call. The trap handler in the kernel requests a DMA transfer from the disk controller and arranges for the disk to interrupt the



**Figure 8.14 Anatomy of a process context switch.**

processor after the disk controller has finished transferring the data from disk to memory.

The disk will take a relatively long time to fetch the data (on the order of tens of milliseconds), so instead of waiting and doing nothing in the interim, the kernel performs a context switch from process A to B. Note that, before the switch, the kernel is executing instructions in user mode on behalf of process A (i.e., there is no separate kernel process). During the first part of the switch, the kernel is executing instructions in kernel mode on behalf of process A. Then at some point it begins executing instructions (still in kernel mode) on behalf of process B. And after the switch, the kernel is executing instructions in user mode on behalf of process B.

Process B then runs for a while in user mode until the disk sends an interrupt to signal that data have been transferred from disk to memory. The kernel decides that process B has run long enough and performs a context switch from process B to A, returning control



in process A to the instruction immediately following the `read` system call. Process A continues to run until the next exception occurs, and so on.

[OceanofPDF.com](http://OceanofPDF.com)

## 8.3 System Call Error Handling

When Unix system-level functions encounter an error, they typically return -1 and set the global integer variable `errno` to indicate what went wrong. Programmers should *always* check for errors, but unfortunately, many skip error checking because it bloats the code and makes it harder to read. For example, here is how we might check for errors when we call the Linux `fork` function:

```
|  
1     if ((pid = fork()) < 0) {  
2         fprintf(stderr, "fork error: %s\n",  
strerror(errno));  
3         exit(0);  
4     }
```

The `strerror` function returns a text string that describes the error associated with a particular value of `errno`. We can simplify this code somewhat by defining the following *error-reporting function*:

```

|
1     void unix_error(char *msg) /* Unix-style error */
2     {
3         fprintf(stderr, "%s: %s\n", msg,
strerror(errno));
4         exit(0);
5     }

```

Given this function, our call to `fork` reduces from four lines to two lines:

```

|
1         if ((pid = fork()) < 0)
2             unix_error("fork error");

```

We can simplify our code even further by using *error-handling wrappers*, as pioneered by Stevens in [110]. For a given base function `foo`, we define a wrapper function `Foo` with identical arguments but with the first letter of the name capitalized. The wrapper calls the base function, checks for errors, and terminates if

there are any problems. For example, here is the error-handling wrapper for the `fork` function:

```
1 pid_t Fork(void)
2 {
3     pid_t pid;
4
5     if ((pid = fork()) < 0)
6         unix_error("Fork error");
7     return pid;
8 }
```

Given this wrapper, our call to `fork` shrinks to a single compact line:

```
1 pid = Fork();
```

We will use error-handling wrappers throughout the remainder of this book. They allow us to keep our code examples concise without giving you the mistaken impression that it is permissible to ignore error checking. Note that when we discuss system-level functions in the text, we will always refer to them by their lowercase base names, rather than by their uppercase wrapper names.

See Appendix A for a discussion of Unix error handling and the error-handling wrappers used throughout this book. The wrappers are defined in a file called `csapp.c`, and their prototypes are defined in a header file called `csapp.h`. These are available online from the CS:APP Web site.

[OceanofPDF.com](http://OceanofPDF.com)

## 8.4 Process Control

Unix provides a number of system calls for manipulating processes from C programs. This section describes the important functions and gives examples of how they are used.

## 8.4.1 Obtaining Process IDs

Each process has a unique positive (nonzero) *process ID (PID)*. The `getpid` function returns the PID of the calling process. The `getppid` function returns the PID of its *parent* (i.e., the process that created the calling process).

```
|  
#include <sys/types.h>  
#include <unistd.h>  
pid_t getpid(void);  
pid_t getppid(void);  
Returns: PID of either the  
caller or the parent
```

The `getpid` and `getppid` routines return an integer value of type `pid_t`, which on Linux systems is defined in `types.h` as an `int`.

## 8.4.2 Creating and Terminating Processes

From a programmer's perspective, we can think of a process as being in one of three states:

**Running.** The process is either executing on the CPU or waiting to be executed and will eventually be scheduled by the kernel.

**Stopped.** The execution of the process is *suspended* and will not be scheduled. A process stops as a result of receiving a SIGSTOP, SIGTSTP, SIGTTIN, or SIGTTOU signal, and it remains stopped until it receives a SIGCONT signal, at which point it becomes running again. (A *signal* is a form of software interrupt that we will describe in detail in [Section 8.5](#).)

**Terminated.** The process is stopped permanently. A process becomes terminated for one of three reasons: (1) receiving a signal whose default action is to terminate the process, (2) returning from the main routine, or (3) calling the `exit` function.



```
|  
#include <stdlib.h>  
void exit(int status);  
This function does not return
```

The `exit` function terminates the process with an *exit status* of `status`. (The other way to set the exit status is to return an integer value from the main routine.)


A *parent process* creates a new running *child process* by calling the `fork` function.

```
|  
#include <sys/types.h>  
#include <unistd.h>  
pid_t fork(void);  
Returns: 0 to child, PID of child to  
parent, -1 on error
```

The newly created child process is almost, but not quite, identical to the parent. The child gets an identical (but separate) copy of the

parent's user-level virtual address space, including the code and data segments, heap, shared libraries, and user stack. The child also gets identical copies of any of the parent's open file descriptors, which means the child can read and write any files that were open in the parent when it called `fork`. The most significant difference between the parent and the newly created child is that they have different PIDs.

The `fork` function is interesting (and often confusing) because it is called *once* but it returns *twice*: once in the calling process (the parent), and once in the newly created child process. In the parent, `fork` returns the PID of the child. In the child, `fork` returns a value of 0. Since the PID of the child is always nonzero, the return value provides an unambiguous way to tell whether the program is executing in the parent or the child.

**Figure 8.15**  shows a simple example of a parent process that uses `fork` to create a child process. When the `fork` call returns in line 6, `x` has a value of 1 in both the parent and child. The child increments and prints its copy of `x` in line 8. Similarly, the parent decrements and prints its copy of `x` in line 13.

When we run the program on our Unix system, we get the following result:

```
|  
linux> ./fork  
parent: x=0  
child : x=2
```

There are some subtle aspects to this simple example.

**Call once, return twice.** The `fork` function is called once by the parent, but it returns twice: once to the parent and once to the newly created child. This is fairly straightforward for programs that create a single child. But programs with multiple instances of `fork` can be confusing and need to be reasoned about carefully.

**Concurrent execution.** The parent and the child are separate processes that run concurrently. The instructions in their logical control flows can be interleaved by the kernel in an arbitrary way. When we run the program on our system, the parent process completes its `printf` statement first, followed by the child. However, on another system the reverse might be true. In general, as programmers we can never make assumptions about the interleaving of the instructions in different processes.

---

-----code/ecf/fork.c

```
|
1  int main()
2  {
3      pid_t pid;
4      int x = 1;
5
6      pid = Fork();
7      if (pid == 0) { /* Child */
8          printf("child : x=%d\n", ++x);
9          exit(0);
10     }
11
12     /* Parent */
13     printf("parent: x=%d\n", --x);
14     exit(0);
15 }
```

---

-----code/ecf/fork.c

**Figure 8.15** Using `fork` to create a new process.

**Duplicate but separate address spaces.** If we could halt both the parent and the child immediately after the `fork` function returned in each process, we would see that the address space of each process is identical. Each process has the same user stack, the same local variable values, the same heap, the same global variable values, and the same code. Thus, in our example program, local variable `x` has a value of 1 in both the parent and the child when the `fork` function returns in line 6. However, since the parent and the child are separate processes, they each have their own private address spaces. Any subsequent changes that a parent or child makes to `x` are private and are not reflected in the memory of the other process. This is why the variable `x` has different values in the parent and child when they call their respective `printf` statements.

**Shared files.** When we run the example program, we notice that both parent and child print their output on the screen. The reason is that the child inherits all of the parent's open files. When the parent calls `fork`, the `stdout` file is open and directed to the screen. The child inherits this file, and thus its output is also directed to the screen.

When you are first learning about the `fork` function, it is often helpful to sketch the *process graph*, which is a simple kind of precedence graph that captures the partial ordering of program statements. Each vertex  $a$  corresponds to the execution of a program statement. A directed edge  $a \rightarrow b$  denotes that statement  $a$  “happens before” statement  $b$ . Edges can be labeled with information such as the

current value of a variable. Vertices corresponding to `printf` statements can be labeled with the output of the `printf`. Each graph begins with a vertex that

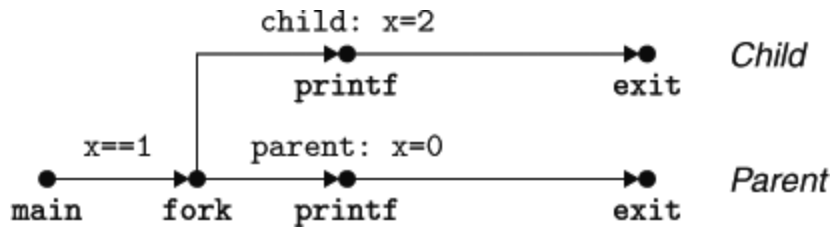


Figure 8.16 Process graph for the example program in Figure 8.15.

```

1  int main()
2  {
3      Fork();
4      Fork();
5      printf("hello\n");
6      exit(0);
7  }

```

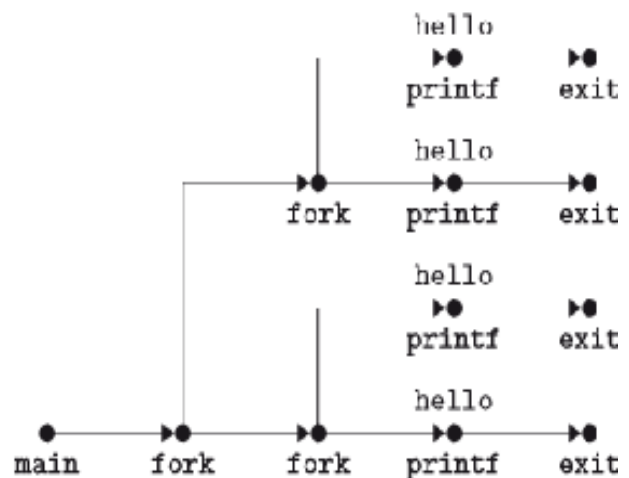






Figure 8.17 Process graph for a nested `fork`.

corresponds to the parent process calling `main`. This vertex has no inedges and exactly one outedge. The sequence of vertices for each process ends with a vertex corresponding to a call to `exit`. This vertex has one inedge and no outedges.

For example, [Figure 8.16](#)  shows the process graph for the example program in [Figure 8.15](#) . Initially, the parent sets variable `x` to 1. The parent calls `fork`, which creates a child process that runs concurrently with the parent in its own private address space.

For a program running on a single processor, any *topological sort* of the vertices in the corresponding process graph represents a feasible total ordering of the statements in the program. Here's a simple way to understand the idea of a topological sort: Given some permutation of the vertices in the process graph, draw the sequence of vertices in a line from left to right, and then draw each of the directed edges. The permutation is a topological sort if and only if each edge in the drawing goes from left to right. Thus, in our example program in [Figure 8.15](#) , the `printf` statements in the parent and child can occur in either order because each of the orderings corresponds to some topological sort of the graph vertices.

The process graph can be especially helpful in understanding programs with nested `fork` calls. For example, [Figure 8.17](#)  shows a program with two calls to `fork` in the source code. The corresponding process graph helps us see that this program runs four processes, each of which makes a call to `printf` and which can execute in any order.

## Practice Problem 8.2 (solution page 795)

Consider the following program:

---

-----code/ecf/forkprob0.c

```
1     int main()
2     {
3         int x = 1;
4
5         if (Fork() == 0)
6             printf("p1: x=%d\n", ++x);
7         printf("p2: x=%d\n", --x);
8         exit(0);
9     }
```

---

-----code/ecf/forkprob0.c

- A. What is the output of the child process?
- B. What is the output of the parent process?



## 8.4.3 Reaping Child Processes

When a process terminates for any reason, the kernel does not remove it from the system immediately. Instead, the process is kept around in a terminated state until it is *reaped* by its parent. When the parent reaps the terminated child, the kernel passes the child's exit status to the parent and then discards the terminated process, at which point it ceases to exist. A terminated process that has not yet been reaped is called a *zombie*.

When a parent process terminates, the kernel arranges for the `init` process to become the adopted parent of any orphaned children. The `init` process, which has a PID of 1, is created by the kernel during system start-up, never terminates, and is the ancestor of every process. If a parent process terminates without reaping its zombie children, then the kernel arranges for the `init` process to reap them. However, long-running programs such as shells or servers should always reap their zombie children. Even though zombies are not running, they still consume system memory resources.

A process waits for its children to terminate or stop by calling the `waitpid` function.

```
|  
#include <sys/types.h>  
#include <sys/wait.h>  
pid_t waitpid(pid_t pid, int *statusp, int options);  
Returns: PID of child if OK, 0 (if  
WNOHANG), or -1 on error
```

## Aside Why are terminated children called zombies?

In folklore, a zombie is a living corpse, an entity that is half alive and half dead. A zombie process is similar in the sense that although it has already terminated, the kernel maintains some of its state until it can be reaped by the parent.

The `waitpid` function is complicated. By default (when `options = 0`), `waitpid` suspends execution of the calling process until a child process in its *wait set* terminates. If a process in the wait set has already terminated at the time of the call, then `waitpid` returns immediately. In either case, `waitpid` returns the PID of the terminated child that caused `waitpid` to return. At this point, the terminated child has been reaped and the kernel removes all traces of it from the system.

## *Determining the Members of the Wait Set*

The members of the wait set are determined by the `pid` argument:

- If `pid > 0`, then the wait set is the singleton child process whose process ID is equal to `pid`.
- If `pid = -1`, then the wait set consists of all of the parent's child processes.

The `waitpid` function also supports other kinds of wait sets, involving Unix process groups, which we will not discuss.

## Modifying the Default Behavior

The default behavior can be modified by setting `options` to various combinations of the `WNOHANG`, `WUNTRACED`, and `WCONTINUED` constants:

**WNOHANG.** Return immediately (with a return value of 0) if none of the child processes in the wait set has terminated yet. The default behavior suspends the calling process until a child terminates; this option is useful in those cases where you want to continue doing useful work while waiting for a child to terminate.

**WUNTRACED.** Suspend execution of the calling process until a process in the wait set becomes either terminated or stopped. Return the PID of the terminated or stopped child that caused the return. The default behavior returns only for terminated children; this option is useful when you want to check for both terminated *and* stopped children.

**WCONTINUED.** Suspend execution of the calling process until a running process in the wait set is terminated or until a stopped process in the wait set has been resumed by the receipt of a `SIGCONT` signal. (Signals are explained in [Section 8.5](#).)

You can combine options by `ORing` them together. For example:

- `WNOHANG | WUNTRACED`: Return immediately, with a return value of 0, if none of the children in the wait set has stopped or

terminated, or with a return value equal to the PID of one of the stopped or terminated children.

# Checking the Exit Status of a Reaped Child

If the `statusp` argument is non-NULL, then `waitpid` encodes status information about the child that caused the return in `status`, which is the value pointed to by `statusp`. The `wait.h` include file defines several macros for interpreting the `status` argument:

**WIFEXITED(`status`)**. Returns true if the child terminated normally, via a call to `exit` or a return.

**WEXITSTATUS(`status`)**. Returns the exit status of a normally terminated child. This status is only defined if `WIFEXITED()` returned true.

**WIFSIGNALED(`status`)**. Returns true if the child process terminated because of a signal that was not caught.

**WTERMSIG(`status`)**. Returns the number of the signal that caused the child process to terminate. This status is only defined if `WIFSIGNALED()` returned true.

**WIFSTOPPED(`status`)**. Returns true if the child that caused the return is currently stopped.

**WSTOPSIG(`status`)**. Returns the number of the signal that caused the child to stop. This status is only defined if `WIFSTOPPED()` returned true.

**WIFCONTINUED(*status*)**. Returns true if the child process was restarted by receipt of a SIGCONT signal.

## *Error Conditions*

If the calling process has no children, then `waitpid` returns -1 and sets `errno` to ECHILD. If the `waitpid` function was interrupted by a signal, then it returns -1 and sets `errno` to EINTR.



## Practice Problem 8.3 (solution page [797](#))

List all of the possible output sequences for the following program:

-----  
-----code/ecf/waitprob0.c

```
|
1  int main()
2  {
3      if (Fork() == 0) {
4          printf("a"); fflush(stdout);
5      }
6      else {
7          printf("b"); fflush(stdout);
8          waitpid(-1, NULL, 0);
9      }
10     printf("c"); fflush(stdout);
11     exit(0);
12 }
```

-----  
-----code/ecf/waitprob0.c

## The `wait` Function

The `wait` function is a simpler version of `waitpid`.

```
|  
#include <sys/types.h>
```

```
#include <sys/wait.h>
```


```
pid_t wait(int *statusp);
```

```
Returns: PID of child if OK or
```

```
-1 on error
```

Calling `wait(&status)` is equivalent to calling `waitpid(-1, &status, 0)`.

## *Examples of Using `waitpid`*

Because the `waitpid` function is somewhat complicated, it is helpful to look at a few examples. **Figure 8.18**  shows a program that uses `waitpid` to wait, in no particular order, for all of its  $N$  children to terminate. In line 11, the parent creates each of the  $N$  children, and in line 12, each child exits with a unique exit status.

# Aside Constants associated with Unix functions

Constants such as `WNOHANG` and `WUNTRACED` are defined by system header files. For example, `WNOHANG` and `WUNTRACED` are defined (indirectly) by the `wait.h` header file:

```
/* Bits in the third argument to 'waitpid'. */  
#define WNOHANG 1 /* Don't block waiting. */  
#define WUNTRACED 2 /* Report status of stopped children.  
*/
```

In order to use these constants, you must include the `wait.h` header file in your code:

```
#include <sys/wait.h>
```

The `man` page for each Unix function lists the header files to include whenever you use that function in your code. Also, in

order to check return codes such as ECHILD and EINTR, you must include `errno.h`. To simplify our code examples, we include a single header file called `csapp.h` that includes the header files for all of the functions used in the book. The `csapp.h` header file is available online from the CS:APP Web site.

-----

-----code/ecf/waitpid1.c

```

1  #include "csapp.h"
2  #define N 2
3
4  int main()
5  {
6      int status, i;
7      pid_t pid;
8
9      /* Parent creates N children */
10     for (i = 0; i < N; i++)
11         if ((pid = Fork()) == 0) /* Child */
12             exit(100+i);
13
14     /* Parent reaps N children in no particular
order */
15     while ((pid = waitpid(-1, &status, 0)) > 0) {
16         if (WIFEXITED(status))
17             printf("child %d terminated
normally with exit status=%d\n",
18                 pid,
WEXITSTATUS(status));
19         else
20             printf("child %d terminated
abnormally\n", pid);
21     }
22

```

```
23          /* The only normal termination is if there are
no more children */
24          if (errno != ECHILD)
25              unix_error("waitpid error");
26
27          exit(0);
28      }
```

---

-----code/ecf/waitpid1.c

**Figure 8.18** Using the `waitpid` function to reap zombie children in no particular order.

---

-----code/ecf/waitpid1.c

Before moving on, make sure you understand why line 12 is executed by each of the children, but not the parent.

In line 15, the parent waits for all of its children to terminate by using `waitpid` as the test condition of a while loop. Because the first argument is -1, the call to `waitpid` blocks until an arbitrary child has terminated. As each child terminates, the call to `waitpid` returns with the nonzero PID of that child. Line 16 checks the exit status of the child. If the child terminated normally—in this case, by calling the




`exit` function—then the parent extracts the exit status and prints it on `stdout`.

When all of the children have been reaped, the next call to `waitpid` returns `-1` and sets `errno` to `ECHILD`. Line 24 checks that the `waitpid` function terminated normally, and prints an error message otherwise. When we run the program on our Linux system, it produces the following output:

```
linux> ./waitpid1  
child 22966 terminated normally with exit status=100  
child 22967 terminated normally with exit status=101
```

Notice that the program reaps its children in no particular order. The order that they were reaped is a property of this specific computer system. On another system, or even another execution on the same system, the two children might have been reaped in the opposite order. This is an example of the *nondeterministic* behavior that can make reasoning about concurrency so difficult. Either of the two possible outcomes is equally correct, and as a programmer you may *never* assume that one outcome will always occur, no matter how unlikely the other outcome appears to be. The only correct assumption is that each possible outcome is equally likely.

**Figure 8.19**  shows a simple change that eliminates this nondeterminism in the output order by reaping the children in the same order that they were created by the parent. In line 11, the parent stores the PIDs of its children in order and then waits for each child in this same order by calling `waitpid` with the appropriate PID in the first argument.

## Practice Problem 8.4 (solution page [797](#))

Consider the following program:

-----

-----*code/ecf/waitprob1.c*

```
|
1     int main()
2     {
3         int status;
4         pid_t pid;
5
6         printf("Hello\n");
7         pid = Fork();
8         printf("%d\n", !pid);
9         if (pid != 0) {
10            if (waitpid(-1, &status, 0) > 0) {
11                if (WIFEXITED(status) != 0)
12                    printf("%d\n",
WEXITSTATUS(status));
13            }
14        }
15        printf("Bye\n");
16        exit(2);
17    }
```

---

-----code/ecf/waitprob1.c

- A. How many output lines does this program generate?
- B. What is one possible ordering of these output lines?

-----

-----code/ecf/waitpid2.c

```

1  #include "csapp.h"
2  #define N 2
3
4  int main()
5  {
6      int status, i;
7      pid_t pid[N], retpid;
8
9      /* Parent creates N children */
10     for (i = 0; i < N; i++)
11         if ((pid[i] = Fork()) == 0) /* Child */
12             exit(100+i);
13
14     /* Parent reaps N children in order */
15     i = 0;
16     while ((retpid = waitpid(pid[i++], &status, 0))
17 > 0) {
18         if (WIFEXITED(status))
19             printf("child %d terminated
20 normally with exit status=%d\n",
21                 retpid,
22 WEXITSTATUS(status));
23         else
24             printf("child %d terminated
25 abnormally\n", retpid);
26     }

```

```
23
24         /* The only normal termination is if there are
no more children */
25         if (errno != ECHILD)
26             unix_error("waitpid error");
27
28         exit(0);
29     }
```

---

-----code/ecf/waitpid2.c

**Figure 8.19** Using `waitpid` to reap zombie children in the order they were created.

## 8.4.4 Putting Processes to Sleep

The `sleep` function suspends a process for a specified period of time.

```
|  
#include <unistd.h>  
unsigned int sleep(unsigned int secs);  
Returns: seconds left to  
sleep
```

`sleep` returns zero if the requested amount of time has elapsed, and the number of seconds still left to sleep otherwise. The latter case is possible if the `sleep` function returns prematurely because it was interrupted by a *signal*. We will discuss signals in detail in [Section 8.5](#).

Another function that we will find useful is the `pause` function, which puts the calling function to sleep until a signal is received by the process.



```
|  
#include <unistd.h>  
int pause(void);  
Always returns -1
```

## *Practice Problem 8.5 (solution page [797](#))*

Write a wrapper function for `sleep`, called `snooze`, with the following interface:

```
unsigned int snooze(unsigned int secs);
```

The `snooze` function behaves exactly as the `sleep` function, except that it prints a message describing how long the process actually slept:

```
Slept for 4 of 5 secs.
```

## 8.4.5 Loading and Running Programs

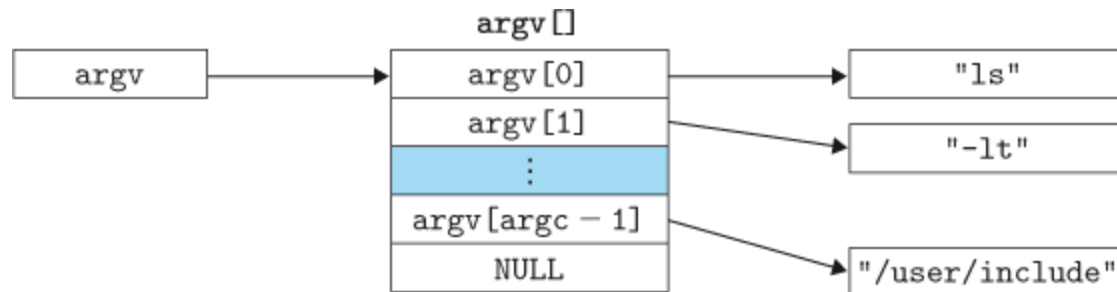
The `execve` function loads and runs a new program in the context of the current process.

```
|  
#include <unistd.h>  
int execve(const char *filename, const char *argv[],  
const char *envp[]);  
Does not return if OK; returns -1 on error
```

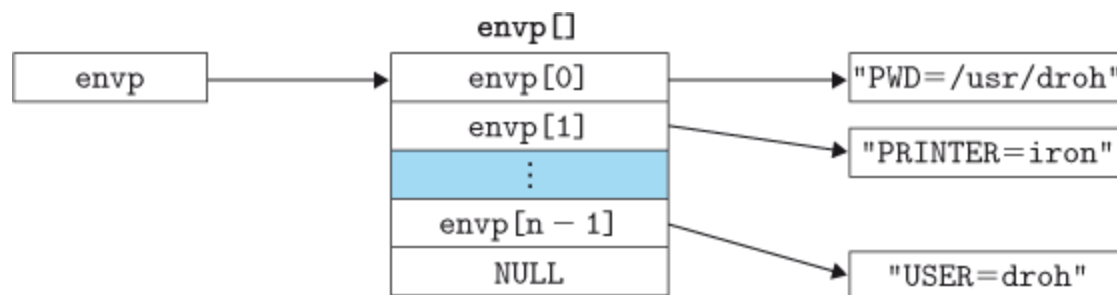
The `execve` function loads and runs the executable object file `filename` with the argument list `argv` and the environment variable list `envp`. `Execve` returns to the calling program only if there is an error, such as not being able to find `filename`. So unlike `fork`, which is called once but returns twice, `execve` is called once and never returns.

The argument list is represented by the data structure shown in [Figure 8.20](#). The `argv` variable points to a null-terminated array of pointers, each of which points to an argument string. By convention,

`argv[0]` is the name of the executable object file. The list of environment variables is represented by a similar data structure, shown in [Figure 8.21](#). The `envp` variable points to a null-terminated array of pointers to environment variable strings, each of which is a name-value pair of the form *name=value*.



**Figure 8.20** Organization of an argument list.



**Figure 8.21** Organization of an environment variable list.

After `execve` loads `filename`, it calls the start-up code described in [Section 7.9](#). The start-up code sets up the stack and passes control to the main routine of the new program, which has a prototype of the form

```
int main(int argc, char **argv, char **envp);
```

or equivalently,

```
int main(int argc, char *argv[], char *envp[]);
```

When `main` begins executing, the user stack has the organization shown in [Figure 8.22](#). Let's work our way from the bottom of the stack (the highest address) to the top (the lowest address). First are the argument and environment strings. These are followed further up the stack by a null-terminated array of pointers, each of which points to an environment variable string on the stack. The global variable `environ` points to the first of these pointers, `envp [0]`. The environment array is followed by the null-terminated `argv []` array, with each element pointing to an argument string on the stack. At the top of the stack is the stack frame for the system start-up function, `libc_start_main` ([Section 7.9](#)).

There are three arguments to function `main`, each stored in a register according to the x86-64 stack discipline: (1) `argc`, which gives the number of non-null pointers in the `argv []` array; (2) `argv`, which points to the first entry in the `argv []` array; and (3) `envp`, which points to the first entry in the `envp []` array.

Linux provides several functions for manipulating the environment array:

```
|  
#include <stdlib.h>  
char *getenv(const char *name);  
Returns: pointer to name if it  
exists, NULL if no match
```

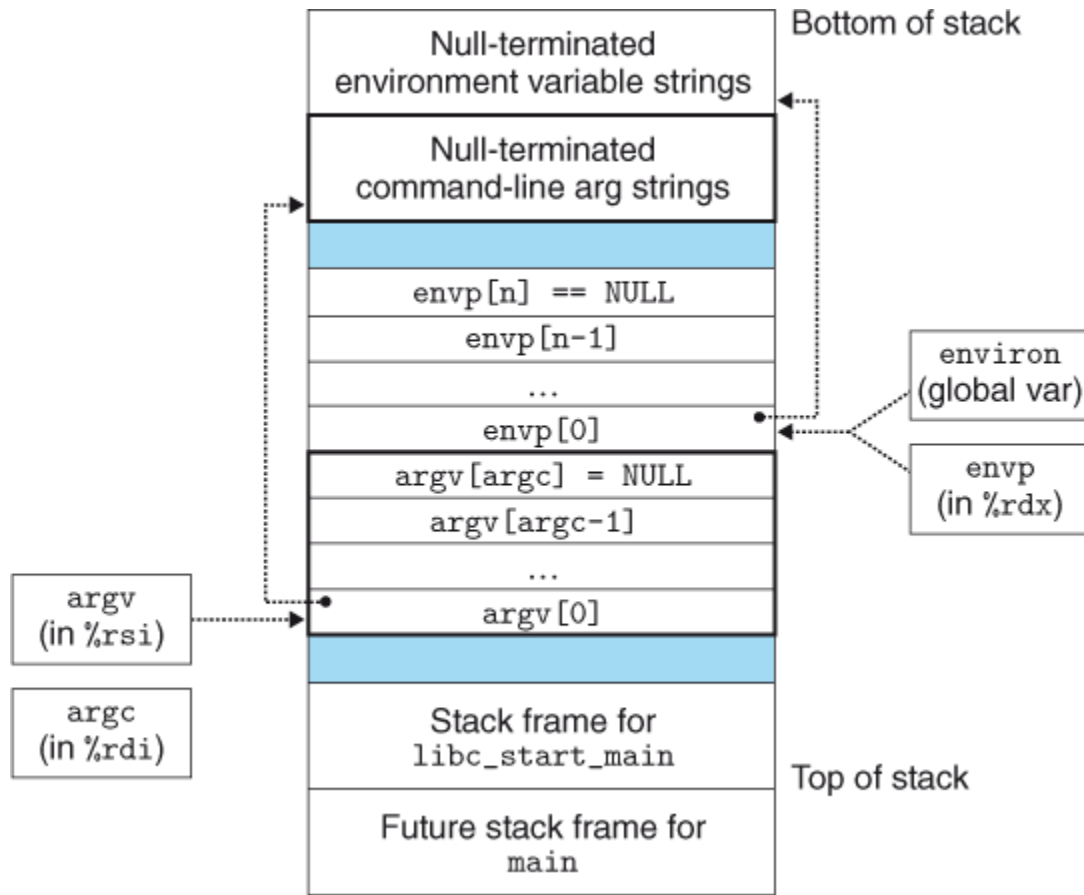


Figure 8.22 Typical organization of the user stack when a new program starts.

The `getenv` function searches the environment array for a string `name=value`. If found, it returns a pointer to `value`; otherwise, it returns `NULL`.

```
|  
#include <stdlib.h>  
int setenv(const char *name, const char *newvalue, int  
overwrite);  
Returns: 0 on success,  
-1 on error  
void unsetenv(const char *name);  
Returns: nothing
```

If the environment array contains a string of the form `name=oldvalue`, then `unsetenv` deletes it and `setenv` replaces `oldvalue` with `newvalue`, but only if `overwrite` is nonzero. If name does not exist, then `setenv` adds `name=newvalue` to the array.

## Practice Problem 8.6 (solution page 797)


Write a program called `myecho` that prints its command-line arguments and environment variables. For example:



```
|
linux> ./myecho arg1 arg2
Command-line arguments:
argv[ 0]: myecho
argv[ 1]: arg1
argv[ 2]: arg2
Environment variables :
envp[ 0]: PWD=/usr0/droh/ics/code/ecf
envp [ 1]: TERM=emacs
:
envp[25]: USER=droh
envp[26]: SHELL=/usr/local/bin/tcsh
envp[27]: HOME=/usr0/droh
```



## 8.4.6 Using `fork` and `execve` to Run Programs

Programs such as Unix shells and Web servers make heavy use of the `fork` and `execve` functions. A *shell* is an interactive application-level program that runs other programs on behalf of the user. The original shell was the `sh` program, which was followed by variants such as `csch`, `tcsh`, `ksh`, and `bash`. A shell performs a sequence of *read/evaluate* steps and then terminates. The read step reads a command line from the user. The evaluate step parses the command line and runs programs on behalf of the user.

**Figure 8.23**  shows the main routine of a simple shell. The shell prints a command-line prompt, waits for the user to type a command line on `stdin`, and then evaluates the command line.

**Figure 8.24**  shows the code that evaluates the command line. Its first task is to call the `parseline` function (**Figure 8.25** ), which parses the space-separated command-line arguments and builds the `argv` vector that will eventually be passed to `execve`. The first argument is assumed to be either the name of a built-in shell command that is interpreted immediately, or an executable object file that will be loaded and run in the context of a new child process.

If the last argument is an '&' character, then `parseLine` returns 1, indicating that the program should be executed in the *background* (the shell does not wait for it to complete). Otherwise, it returns 0, indicating that the program should be run in the *foreground* (the shell waits for it to complete).

## Aside Programs versus processes

This is a good place to pause and make sure you understand the distinction between a program and a process. A program is a collection of code and data; programs can exist as object files on disk or as segments in an address space. A process is a specific instance of a program in execution; a program always runs in the context of some process. Understanding this distinction is important if you want to understand the `fork` and `execve` functions. The `fork` function runs the same program in a new child process that is a duplicate of the parent. The `execve` function loads and runs a new program in the context of the current process. While it overwrites the address space of the current process, it does *not* create a new process. The new program still has the same PID, and it inherits all of the file descriptors that were open at the time of the call to the `execve` function.

-----

-----code/ecf/shellex.c

```
|
1  #include "csapp.h"
2  #define MAXARGS 128
3
4  /* Function prototypes */
5  void evaKchar *cmdline);
6  int parseline(char *buf, char **argv);
7  int builtin_command(char **argv);
8
9  int main()
10 {
11     char cmdline[MAXLINE]; /* Command line */
12
13     while (1) {
14         /* Read */
15         printf("> ");
16         Fgets(cmdline, MAXLINE, stdin);
17         if (feof(stdin))
18             exit(0);
19
20         /* Evaluate */
21         eval(cmdline);
22     }
23 }
```

-----  
-----code/ecf/shellex.c

### Figure 8.23 The main routine for a simple shell program.

After parsing the command line, the `eval` function calls the `builtin_command` function, which checks whether the first command-line argument is a built-in shell command. If so, it interprets the command immediately and returns 1. Otherwise, it returns 0. Our simple shell has just one built-in command, the `quit` command, which terminates the shell. Real shells have numerous commands, such as `pwd`, `jobs`, and `fg`.

If `builtin_command` returns 0, then the shell creates a child process and executes the requested program inside the child. If the user has asked for the program to run in the background, then the shell returns to the top of the loop and waits for the next command line. Otherwise the shell uses the `waitpid` function to wait for the job to terminate. When the job terminates, the shell goes on to the next iteration.

Notice that this simple shell is flawed because it does not reap any of its background children. Correcting this flaw requires the use of signals, which we describe in the next section.

-----

-----code/ecf/shellex.c

```

1      /* eval - Evaluate a command line */
2      void eval(char *cmdline)
3      {
4          char *argv[MAXARGS]; /* Argument list
execve() */
5          char buf[MAXLINE]; /* Holds modified
command line */
6          int bg; /* Should the job run in bg or fg? */
7          pid_t pid; /* Process id */
8
9          strcpy(buf, cmdline);
10         bg = parseline(buf, argv);
11         if (argv[0] == NULL)
12             return; /* Ignore empty lines */
13
14         if (!builtin_command(argv)) {
15             if ((pid = Fork()) == 0) { /* Child
runs user job */
16                 if (execve(argv[0], argv,
environ) < 0) {
17                     printf("%s: Command not
found.\n", argv[0]);
18                     exit(0);
19                 }
20             }
21
22             /* Parent waits for foreground job to

```

```

terminate */
23         if (!bg) {
24             int status;
25             if (waitpid(pid, &status, 0) <
0)
26                 unix_error("waitfg:
waitpid error");
27         }
28         else
29             printf ("%d %s", pid, cmdline);
30     }
31     return;
32 }
33
34     /* If first arg is a builtin command, run it and return
true */
35     int builtin_command(char **argv)
36     {
37         if (!strcmp(argv[0], "quit")) /* quit command
*/
38             exit(0);
39         if (!strcmp(argv[0], "&")) /* Ignore
singleton & */
40             return 1;
41         return 0; /* Not a builtin command */
42     }

```



-----  
-----code/ecf/shellex.c

**Figure 8.24** `eval` evaluates the shell command line.

-----

-----code/ecf/shellex.c

```

1      /* parseline - Parse the command line and build the argv
array */
2      int parseline(char *buf, char **argv)
3      {
4          char *delim; /* Points to first space
delimiter */
5          int argc; /* Number of args */
6          int bg; /* Background job? */
7
8          buf[strlen(buf) -1] = ' '; /* Replace
trailing '\n' with space */
9          while (*buf && (*buf == ' ')) /* Ignore leading
spaces */
10             buf++;
11
12         /* Build the argv list */
13         argc = 0;
14         while ((delim = strchr(buf, ' ')) {
15             argv [argc++] = buf;
16             *delim = '\0';
17             buf = delim + 1;
18             while (*buf && (*buf == ' ')) /* Ignore
spaces */
19                 buf++;
20         }
21         argv [argc] = NULL;
22

```

```
23         if (argc == 0) /* Ignore blank line */
24             return 1;
25
26         /* Should the job run in the background? */
27         if ((bg = (*argv[argc-1] == '&')) != 0)
28             argv[-argc] = NULL;
29
30         return bg;
31     }
```

---

-----code/ecf/shellex.c

**Figure 8.25** `parseLine` parses a line of input for the shell.

[OceanofPDF.com](http://OceanofPDF.com)


## 8.5 Signals

To this point in our study of exceptional control flow, we have seen how hardware and software cooperate to provide the fundamental low-level exception mechanism. We have also seen how the operating system uses exceptions to support a form of exceptional control flow known as the process context switch. In this section, we will study a higher-level software form of exceptional control flow, known as a Linux signal, that allows processes and the kernel to interrupt other processes.

## Figure 8.26 Linux signals.

**Notes:** (a) Years ago, main memory was implemented with a technology known as *core memory*. “Dumping core” is a historical term that means writing an image of the code and data memory segments to disk, (b) This signal can be neither caught nor ignored.

(Source: `man 7 signal`. Data from the Linux Foundation.)


A *signal* is a small message that notifies a process that an event of some type has occurred in the system. **Figure 8.26**  shows the 30 different types of signals that are supported on Linux systems.

Each signal type corresponds to some kind of system event. Low-level hardware exceptions are processed by the kernel's exception handlers and would not normally be visible to user processes. Signals provide a mechanism for exposing the occurrence of such exceptions to user processes. For example, if a process attempts to divide by zero, then the kernel sends it a SIGFPE signal (number 8). If a process executes an illegal instruction, the kernel sends it a SIGILL signal (number 4). If a process makes an illegal memory reference, the kernel sends it a SIGSEGV signal (number 11). Other signals correspond to higher-level software events in the kernel or in other user processes. For example, if you type Ctrl+C (i.e., press the Ctrl key and the ‘c’ key at the same time) while a process is running in the foreground, then the kernel sends a SIGINT (number 2) to each process in the foreground process group. A process can forcibly terminate another process by sending it a SIGKILL signal (number 9). When a child process terminates or stops, the kernel sends a SIGCHLD signal (number 17) to the parent.

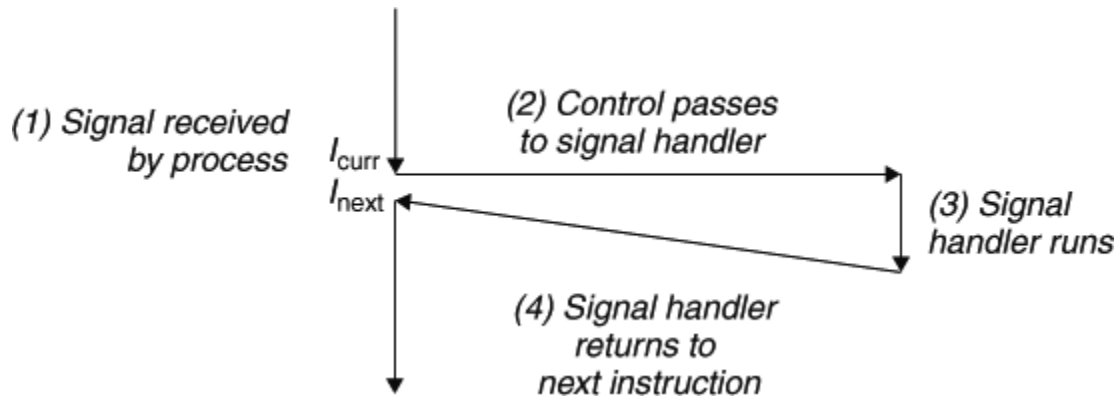
## 8.5.1 Signal Terminology

The transfer of a signal to a destination process occurs in two distinct steps:

**Sending a signal.** The kernel *sends (delivers)* a signal to a destination process by updating some state in the context of the destination process. The signal is delivered for one of two reasons: (1) The kernel has detected a system event such as a divide-by-zero error or the termination of a child process. (2) A process has invoked the `kill` function (discussed in the next section) to explicitly request the kernel to send a signal to the destination process. A process can send a signal to itself.

**Receiving a signal.** A destination process *receives* a signal when it is forced by the kernel to react in some way to the delivery of the signal. The process can either ignore the signal, terminate, or *catch* the signal by executing a user-level function called a *signal handler*. [Figure 8.27](#)  shows the basic idea of a handler catching a signal.

A signal that has been sent but not yet received is called *pending signal*. At any point in time, there can be at most one pending signal of a particular type. If a process has a pending signal of type  $k$ , then any subsequent signals of type  $k$  sent to that process are *not* queued; they are simply discarded. A process can selectively *block* the receipt of certain signals. When a signal is blocked, it can be



**Figure 8.27 Signal handling.**

Receipt of a signal triggers a control transfer to a signal handler. After it finishes processing, the handler returns control to the interrupted program.

delivered, but the resulting pending signal will not be received until the process unblocks the signal.

A pending signal is received at most once. For each process, the kernel maintains the set of pending signals in the `pending` bit vector, and the set of blocked signals in the `blocked` bit vector.<sup>1</sup> The kernel sets bit  $k$  in `pending` whenever a signal of type  $k$  is delivered and clears bit  $k$  in `pending` whenever a signal of type  $k$  is received.

<sup>1</sup>. Also known as the *signal mask*.



## 8.5.2 Sending Signals

Unix systems provide a number of mechanisms for sending signals to processes. All of the mechanisms rely on the notion of a *process group*.

# Process Groups

Every process belongs to exactly one *process group*, which is identified by a positive *integer process group ID*. The `getpgrp` function returns the process group ID of the current process.

```
|  
#include <unistd.h>  
pid_t getpgrp(void);  
Returns: process group ID of  
calling process
```

By default, a child process belongs to the same process group as its parent. A process can change the process group of itself or another process by using the `setpgid` function:

```
|  
#include <unistd.h>  
int setpgid(pid_t pid, pid_t pgid);  
Returns: 0 on success, -1 on  
error
```

The `setpgid` function changes the process group of process `pid` to `pgid`. If `pid` is zero, the PID of the current process is used. If `pgid` is zero, the PID of the process specified by `pid` is used for the process group ID. For example, if process 15213 is the calling process, then

```
setpgid(0, 0);
```

creates a new process group whose process group ID is 15213, and adds process 15213 to this new group.

## *Sending Signals with the `/bin/kill` Program*

The `/bin/kill` program sends an arbitrary signal to another process. For example, the command

```
linux> /bin/kill -9 15213
```

sends signal 9 (SIGKILL) to process 15213. A negative PID causes the signal to be sent to every process in process group PID. For example, the command

```
linux> /bin/kill -9 -15213
```

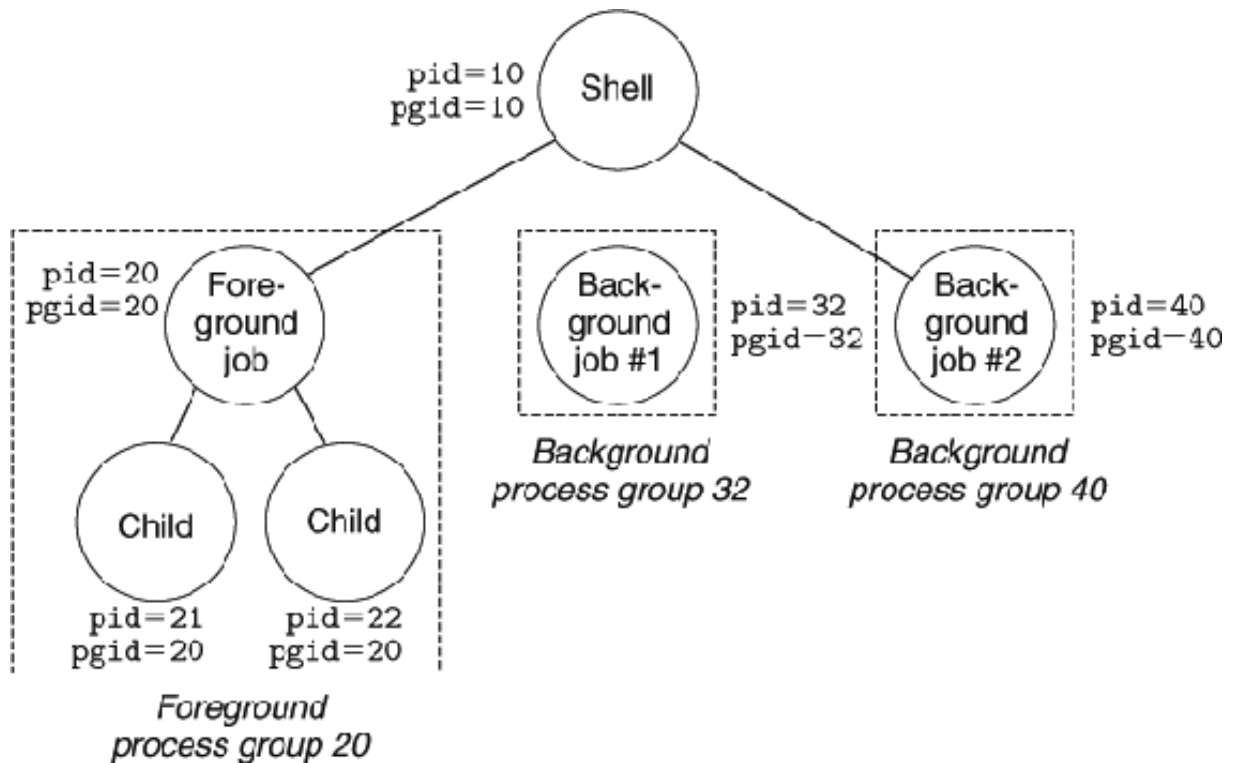
sends a SIGKILL signal to every process in process group 15213. Note that we use the complete path `/bin/kill` here because some Unix shells have their own built-in `kill` command.

## *Sending Signals from the Keyboard*

Unix shells use the abstraction of a *job* to represent the processes that are created as a result of evaluating a single command line. At any point in time, there is at most one foreground job and zero or more background jobs. For example, typing

```
linux> ls / sort
```

creates a foreground job consisting of two processes connected by a Unix pipe: one running the `ls` program, the other running the `sort` program. The shell creates a separate process group for each job. Typically, the process group ID is taken from one of the parent processes in the job. For example, [Figure 8.28](#) shows a shell with one foreground job and two background jobs. The parent process in the foreground job has a PID of 20 and a process group ID of 20. The parent process has created two children, each of which are also members of process group 20.



**Figure 8.28** Foreground and background process groups.

Typing Ctrl+C at the keyboard causes the kernel to send a SIGINT signal to every process in the foreground process group. In the default case, the result is to terminate the foreground job. Similarly, typing Ctrl+Z causes the kernel to send a SIGTSTP signal to every process in the foreground process group. In the default case, the result is to stop (suspend) the foreground job.

## Sending Signals with the `kill` Function

Processes send signals to other processes (including themselves) by calling the `kill` function.

```
|  
#include <sys/types.h>  
#include <signal.h>  
int kill(pid_t pid, int sig);  
Returns: 0 if OK, -1 on error
```

If `pid` is greater than zero, then the `kill` function sends signal number `sig` to process `pid`. If `pid` is equal to zero, then `kill` sends signal `sig` to every process in the process group of the calling process, including the calling process itself. If `pid` is less than zero, then `kill` sends signal `sig` to every process in process group `|pid|` (the absolute value of `pid`). [Figure 8.29](#) shows an example of a parent that uses the `kill` function to send a SIGKILL signal to its child.

---

-----code/ecf/kill.c

```
1  #include "csapp.h"
2
3  int main()
4  {
5      pid_t pid;
6
7      /* Child sleeps until SIGKILL signal received,
then dies */
8      if ((pid = Fork()) == 0) {
9          Pause(); /* Wait for a signal to arrive
*/
10         printf("control should never reach
here!\n");
11         exit(0);
12     }
13
14     /* Parent sends a SIGKILL signal to a child */
15     Kill(pid, SIGKILL);
16     exit(0);
17 }
```



---

-----code/ecf/kill.c

Figure 8.29 Using the `kill` function to send a signal to a child.

## *Sending Signals with the `alarm` Function*

A process can send SIGALRM signals to itself by calling the `alarm` function.


```
|  
#include <unistd.h>  
unsigned int alarm(unsigned int secs);  
Returns: remaining seconds of  
previous alarm, or 0 if no previous alarm
```

The `alarm` function arranges for the kernel to send a SIGALRM signal to the calling process in `secs` seconds. If `secs` is 0, then no new alarm is scheduled. In any event, the call to `alarm` cancels any pending alarms and returns the number of seconds remaining until any pending alarm was due to be delivered (had not this call to `alarm` canceled it), or 0 if there were no pending alarms.

## 8.5.3 Receiving Signals

When the kernel switches a process  $p$  from kernel mode to user mode (e.g., returning from a system call or completing a context switch), it checks the set of unblocked pending signals (`pending & ~blocked`) for  $p$ . If this set is empty (the usual case), then the kernel passes control to the next instruction ( $I_{\text{next}}$ ) in the logical control flow of  $p$ . However, if the set is nonempty, then the kernel chooses some signal  $k$  in the set (typically the smallest  $k$ ) and forces  $p$  to *receive* signal  $k$ . The receipt of the signal triggers some *action* by the process. Once the process completes the action, then control passes back to the next instruction ( $I_{\text{next}}$ ) in the logical control flow of  $p$ . Each signal type has a predefined *default action*, which is one of the following:

- The process terminates.
- The process terminates and dumps core.
- The process stops (suspends) until restarted by a SIGCONT signal.
- The process ignores the signal.

**Figure 8.26**  shows the default actions associated with each type of signal. For example, the default action for the receipt of a SIGKILL is to terminate the receiving process. On the other hand, the default action for the receipt of a SIGCHLD is to ignore the signal. A process can modify the default action associated with a signal by using the

`signal` function. The only exceptions are SIGSTOP and SIGKILL, whose default actions cannot be changed.


```
|  
#include <signal.h>  
typedef void (*sighandler_t)(int);  
sighandler_t signal(int signum, sighandler_t handler);  
Returns: pointer to previous  
handler if OK, SIG_ERR on error (does not set errno)
```

The `signal` function can change the action associated with a signal `signum` in one of three ways:

- If `handler` is SIG\_IGN, then signals of type `signum` are ignored.
- If `handler` is SIG\_DFL, then the action for signals of type `signum` reverts to the default action.
- Otherwise, `handler` is the address of a user-defined function, called a *signal handler*, that will be called whenever the process receives a signal of type `signum`. Changing the default action by passing the address of a handler to the `signal` function is known as *installing the handler*. The invocation of the handler is called *catching the signal*. The execution of the handler is referred to as *handling the signal*.

When a process catches a signal of type  $k$ , the handler installed for signal  $k$  is invoked with a single integer argument set to  $k$ . This argument allows the same handler function to catch different types of signals.

When the handler executes its `return` statement, control (usually) passes back to the instruction in the control flow where the process was interrupted by the receipt of the signal. We say “usually” because in some systems, interrupted system calls return immediately with an error.

**Figure 8.30**  shows a program that catches the SIGINT signal that is sent whenever the user types Ctrl+C at the keyboard. The default action for SIGINT

---

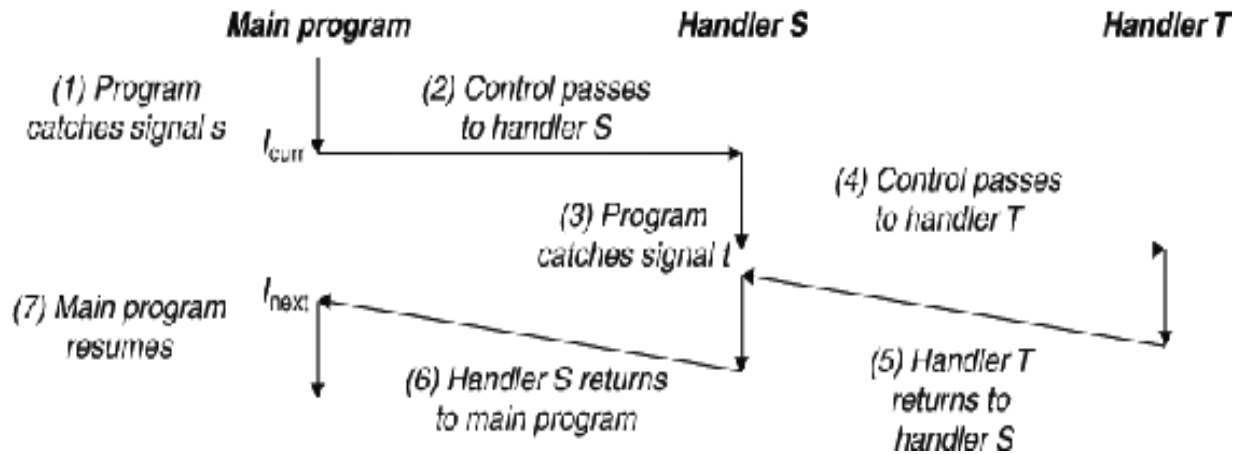
-----code/ecf/sigint.c

```
1  #include "csapp.h"
2
3  void sigint_handler(int sig) /* SIGINT handler */
4  {
5      printf("Caught SIGINT!\n");
6      exit(0);
7  }
8
9  int main()
10 {
11     /* Install the SIGINT handler */
12     if (signal(SIGINT, sigint_handler) == SIG_ERR)
13         unix_error("signal error");
14
15     pause(); /* Wait for the receipt of a signal */
16
17     return 0;
18 }
```

---

-----code/ecf/sigint.c

**Figure 8.30** A program that uses a signal handler to catch a SIGINT signal.



**Figure 8.31** Handlers can be interrupted by other handlers.

is to immediately terminate the process. In this example, we modify the default behavior to catch the signal, print a message, and then terminate the process.

Signal handlers can be interrupted by other handlers, as shown in Figure 8.31. In this example, the main program catches signal  $s$ , which interrupts the main program and transfers control to handler  $S$ . While  $S$  is running, the program catches signal  $t \neq s$ , which interrupts  $S$  and transfers control to handler  $T$ . When  $T$  returns,  $S$  resumes where it was interrupted. Eventually,  $S$  returns, transferring control back to the main program, which resumes where it left off.

## Practice Problem 8.7 (solution page 798)

Write a program called `snooze` that takes a single command-line argument, calls the `snooze` function from [Problem 8.5](#) with this argument, and then terminates. Write your program so that the user can interrupt the `snooze` function by typing Ctrl+C at the keyboard. For example:

```
|  
linux> ./snooze 5  
CTRL+C          User hits Ctrl+C after 3 seconds  
Slept for 3 of 5 secs.  
linux>
```

## 8.5.4 Blocking and Unblocking Signals

Linux provides implicit and explicit mechanisms for blocking signals:

**Implicit blocking mechanism.** By default, the kernel blocks any pending signals of the type currently being processed by a handler. For example, in Figure 8.31, suppose the program has caught signal *s* and is currently running handler *S*. If another signal *s* is sent to the process, then *s* will become pending but will not be received until after handler *S* returns.

**Explicit blocking mechanism.** Applications can explicitly block and unblock selected signals using the `sigprocmask` function and its helpers.



```

|
#include <signal.h>

int sigprocmask(int how, const sigset_t *set, sigset_t *oldset);
int sigemptyset(sigset_t *set);
int sigfillset(sigset_t *set);
int sigaddset(sigset_t *set, int signum);
int sigdelset(sigset_t *set, int signum);
                                Returns: 0 if OK, -1 on error
int sigismember(const sigset_t *set, int signum);
                                Returns: 1 if member, 0 if not,
-1 on error

```

The `sigprocmask` function changes the set of currently `blocked` signals (the `blocked` bit vector described in [Section 8.5.1](#)). The specific behavior depends on the value of `how`:


`SIG_BLOCK`. Add the signals in `set` to `blocked` (`blocked = blocked | set`).

`SIG_UNBLOCK`. Remove the signals in `set` from `blocked` (`blocked = blocked & ~set`).

`SIG_SETMASK`. `blocked = set`.

If `oldset` is non-NULL, the previous value of the `blocked` bit vector is stored in `oldset`.

Signal sets such as `set` are manipulated using the following functions: The `sigemptyset` initializes `set` to the empty set. The `sigfillset` function adds every signal to `set`. The `sigaddset` function adds `signum` to `set`, `sigdelset` deletes `signum` from `set`, and `sigismember` returns 1 if `signum` is a member of `set`, and 0 if not.

For example, **Figure 8.32**  shows how you would use `sigprocmask` to temporarily block the receipt of SIGINT signals.

```
|
1     sigset_t mask, prev_mask;
2
3     Sigemptyset(&mask);
4     Sigaddset(&mask, SIGINT);
5
6     /* Block SIGINT and save previous blocked set */
7     Sigprocmask(SIG_BLOCK, &mask, &prev_mask);
8     : // Code region that will not be interrupted by SIGINT
9     /* Restore previous blocked set, unblocking SIGINT */
10    Sigprocmask(SIG_SETMASK, &prev_mask, NULL);
11
```

**Figure 8.32** Temporarily blocking a signal from being received.

## 8.5.5 Writing Signal Handlers

Signal handling is one of the thornier aspects of Linux system-level programming. Handlers have several attributes that make them difficult to reason about: (1) Handlers run concurrently with the main program and share the same global variables, and thus can interfere with the main program and with other handlers. (2) The rules for how and when signals are received is often counterintuitive. (3) Different systems can have different signal-handling semantics.

In this section, we address these issues and give you some basic guidelines for writing safe, correct, and portable signal handlers.

## Safe Signal Handling


Signal handlers are tricky because they can run concurrently with the main program and with each other, as we saw in Figure 8.31. If a handler and the main program access the same global data structure concurrently, then the results can be unpredictable and often fatal.

We will explore concurrent programming in detail in [Chapter 12](#). Our aim here is to give you some conservative guidelines for writing handlers that are safe to run concurrently. If you ignore these guidelines, you run the risk of introducing subtle concurrency errors. With such errors, your program works correctly most of the time. However, when it fails, it fails in unpredictable and unrepeatable ways that are horrendously difficult to debug. Forewarned is forearmed!

**G0. Keep handlers as simple as possible.** The best way to avoid trouble is to keep your handlers as small and simple as possible. For example, the handler might simply set a global flag and return immediately; all processing associated with the receipt of the signal is performed by the main program, which periodically checks (and resets) the flag.

**G1. Call only *async-signal-safe* functions in your handlers.** A function that is *async-signal-safe*, or simply *safe*, has the property that it can be safely called from a signal handler, either because it is *reentrant* (e.g., accesses only local variables; see [Section 12.7.2](#)), or because it cannot be interrupted by a signal handler. [Figure 8.33](#) lists the system-level functions that Linux

guarantees to be safe. Notice that many popular functions, such as `printf`, `sprintf`, `malloc`, and `exit`, are *not* on this list.


The only safe way to generate output from a signal handler is to use the `write` function (see [Section 10.1](#) ). In particular, calling `printf` or `sprintf` is unsafe. To work around this unfortunate restriction, we have developed some safe functions, called the S<sub>IO</sub> (Safe I/O) package, that you can use to print simple messages from signal handlers.


## Figure 8.33 Async-signal-safe functions.

(Source: `man 7 signal`. Data from the Linux Foundation.)

```
|
#include "csapp.h"
ssize_t sio_putl(long v);
ssize_t sio_puts(char s[]);
Returns: number of bytes
transferred if OK, -1 on error
void sio_error (char s []);
Returns: nothing
```

The `sio_putl` and `sio_puts` functions emit a long and a string, respectively, to standard output. The `sio_error` function prints an error message and terminates.

**Figure 8.34**  shows the implementation of the Sio package, which uses two private reentrant functions from `csapp.c`. The `sio_strlen` function in line 3 returns the length of string `s`. The `sio_ltoa` function in line 10, which is based on the `ltoa` function from [61], converts `v` to its base `b` string representation in `s`. The `_exit` function in line 17 is an async-signal-safe variant of `exit`.

**Figure 8.35**  shows a safe version of the SIGINT handler from **Figure 8.30** .

**G2. Save and restore `errno`.** Many of the Linux async-signal-safe functions set `errno` when they return with an error. Calling such functions inside a handler might interfere with other parts of the program that rely on `errno`.



---

-----code/src/csapp.c


```
|
1     ssize_t sio_puts(char s[]) /* Put string */
2     {
3         return write(STDOUT_FILENO, s,
4             sio_strlen(s));
5
6     ssize_t sio_putl(long v) /* Put long */
7     {
8         char s[128];
9
10        sio_ltoa(v, s, 10); /* Based on K&R itoa() */
11        return sio_puts(s);
12    }
13
14    void sio_error(char s[]) /* Put error message and
15        exit */
16    {
17        sio_puts(s);
18        _exit(1);
19    }
```

---

-----code/src/csapp.c

Figure 8.34 The `SIO` (Safe I/O) package for signal handlers.

```
|
code/ecf/sigintsafe.c
1     #include "csapp.h"
2
3     void sigint_handler(int sig) /* Safe SIGINT handler
*/
4     {
5         Sio_puts("Caught SIGINT!\n"); /* Safe
output */
6         _exit(0); /* Safe exit */
7     }
code/ecf/sigintsafe.c
```

Figure 8.35 A safe version of the SIGINT handler from [Figure 8.30](#) .

The workaround is to save `errno` to a local variable on entry to the handler and restore it before the handler returns. Note that this is only necessary if the handler returns. It is not necessary if the handler terminates the process by calling `_exit`.

**G3. Protect accesses to shared global data structures by blocking all signals.** If a handler shares a global data structure

with the main program or with other handlers, then your handlers and main program should temporarily block all signals while accessing (reading or writing) that data structure. The reason for this rule is that accessing a data structure  $d$  from the main program typically requires a sequence of instructions. If this instruction sequence is interrupted by a handler that accesses  $d$ , then the handler might find  $d$  in an inconsistent state, with unpredictable results. Temporarily blocking signals while you access  $d$  guarantees that a handler will not interrupt the instruction sequence.

**G4. Declare global variables with `volatile`.** Consider a handler and `main` routine that share a global variable  $g$ . The handler updates  $g$ , and `main` periodically reads  $g$ . To an optimizing compiler, it would appear that the value of  $g$  never changes in `main`, and thus it would be safe to use a copy of  $g$  that is cached in a register to satisfy every reference to  $g$ . In this case, the `main` function would never see the updated values from the handler.

You can tell the compiler not to cache a variable by declaring it with the `volatile` type qualifier. For example:

```
volatile int g;
```

The `volatile` qualifier forces the compiler to read the value of  $g$  from memory each time it is referenced in the code. In general, as with any shared data structure, each access to a global variable should be protected by temporarily blocking signals.

**G5. Declare flags with `sig_atomic_t`.** In one common handler design, the handler records the receipt of the signal by writing to a global *flag*. The main program periodically reads the flag, responds to the signal, and clears the flag. For flags that are shared in this way, C provides an integer data type, `sig_atomic_t`, for which reads and writes are guaranteed to be *atomic* (uninterruptible) because they can be implemented with a single instruction:

```
volatile sig_atomic_t flag;
```

Since they can't be interrupted, you can safely read from and write to `sig_atomic_t` variables without temporarily blocking signals. Note that the guarantee of atomicity only applies to individual reads and writes. It does not apply to updates such as `flag++` or `flag = flag + 10`, which might require multiple instructions.


Keep in mind that the guidelines we have presented are conservative, in the sense that they are not always strictly necessary. For example, if you know that a handler can never modify `errno`, then you don't need to save and restore `errno`. Or if you can prove that no instance of `printf` can ever be interrupted by a handler, then it is safe to call `printf` from the handler. The same holds for accesses to shared global data structures. However, it is very difficult to prove such assertions in general. So we recommend that you take the conservative approach and follow the guidelines by

keeping your handlers as simple as possible, calling safe functions, saving and restoring `errno`, protecting accesses to shared data structures, and using `volatile` and `sig_atomic_t`.

## *Correct Signal Handling*

One of the nonintuitive aspects of signals is that pending signals are not queued. Because the `pending` bit vector contains exactly one bit for each type of signal, there can be at most one pending signal of any particular type. Thus, if two signals of type  $k$  are sent to a destination process while signal  $k$  is blocked because the destination process is currently executing a handler for signal  $k$ , then the second signal is simply discarded; it is not queued. The key idea is that the existence of a pending signal merely indicates that *at least* one signal has arrived.

To see how this affects correctness, let's look at a simple application that is similar in nature to real programs such as shells and Web servers. The basic structure is that a parent process creates some children that run independently for a while and then terminate. The parent must reap the children to avoid leaving zombies in the system. But we also want the parent to be free to do other work while the children are running. So we decide to reap the children with a SIGCHLD handler, instead of explicitly waiting for the children to terminate. (Recall that the kernel sends a SIGCHLD signal to the parent whenever one of its children terminates or stops.)

**Figure 8.36**  shows our first attempt. The parent installs a SIGCHLD handler and then creates three children. In the meantime, the parent waits for a line of input from the terminal and then processes it. This processing is modeled by an infinite loop. When

each child terminates, the kernel notifies the parent by sending it a SIGCHLD signal. The parent catches the SIGCHLD, reaps one child,

-----

-----code/ecf/signal1. c



```
1      /* WARNING: This code is buggy! */
2
3      void handler1(int sig)
4      {
5          int olderrno = errno;
6
7          if ((waitpid(-1, NULL, 0)) < 0)
8              sio_error("waitpid error");
9          Sio_puts("Handler reaped child\n");
10         Sleep(1);
11         errno = olderrno;
12     }
13
14     int main()
15     {
16         int i, n;
17         char buf [MAXBUF];
18
19         if (signal(SIGCHLD, handler1) == SIG_ERR)
20             unix_error("signal error");
21
22         /* Parent creates children */
23         for (i = 0; i < 3; i++) {
24             if (Fork() == 0) {
25                 printf ("Hello from child %d\n",
(int)getpid());
```

```

26             exit(0);
27         }
28     }
29
30     /* Parent waits for terminal input and then
processes it */
31     if ((n = read(STDIN_FILENO, buf, sizeof(buf))) <
0)
32         unix_error("read");
33
34     printf("Parent processing input\n");
35     while (1)
36         ;
37
38     exit(0);
39 }


```

---

-----code/ecf/signal1.c

**Figure 8.36** `signal1`. This program is flawed because it assumes that signals are queued.

does some additional cleanup work (modeled by the `sleep` statement), and then returns.

The `signal1` program in [Figure 8.36](#)  seems fairly straightforward. When we run it on our Linux system, however, we get the following output:

```
linux> ./signal1
Hello from child 14073
Hello from child 14074
Hello from child 14075
Handler reaped child
Handler reaped child
CR
Parent processing input
```

From the output, we note that although three SIGCHLD signals were sent to the parent, only two of these signals were received, and thus the parent only reaped two children. If we suspend the parent process, we see that, indeed, child process 14075 was never reaped and remains a zombie (indicated by the string `<def unct>` in the output of the `ps` command):

```

|
Ctrl+Z
Suspended
linux> ps t
PID TTY          STAT     TIME COMMAND
:
14072 pts/3        T         0:02 ./ signal1
14075 pts/3        Z         0:00 [signal1] <defunct>
14076 pts/3        R+        0:00 ps t

```

What went wrong? The problem is that our code failed to account for the fact that signals are not queued. Here's what happened: The first signal is received and caught by the parent. While the handler is still processing the first signal, the second signal is delivered and added to the set of pending signals. However, since SIGCHLD signals are blocked by the SIGCHLD handler, the second signal is not received. Shortly thereafter, while the handler is still processing the first signal, the third signal arrives. Since there is already a pending SIGCHLD, this third SIGCHLD signal is discarded. Sometime later, after the handler has returned, the kernel notices that there is a pending SIGCHLD signal and forces the parent to receive the signal. The parent catches the signal and executes the handler a second time. After the handler finishes processing the second signal, there are no more pending SIGCHLD signals, and there never will be, because all knowledge of the third SIGCHLD has been lost. *The crucial lesson is*

*that signals cannot be used to count the occurrence of events in other processes.*

To fix the problem, we must recall that the existence of a pending signal only implies that at least one signal has been delivered since the last time the process received a signal of that type. So we must modify the SIGCHLD handler to reap


---


-----code/ecf/signal2.c

```
1 void handler2(int sig)
2 {
3     int olderrno = errno;
4
5     while (waitpid(-1, NULL, 0) > 0) {
6         Sio_puts("Handler reaped child\n");
7     }
8     if (errno != ECHILD)
9         Sio_error("waitpid error");
10    Sleep(1);
11    errno = olderrno;
12 }
```

---

-----code/ecf/signal2.c

**Figure 8.37 signal2.** An improved version of [Figure 8.36](#)  that correctly accounts for the fact that signals are not queued.

as many zombie children as possible each time it is invoked. [Figure 8.37](#)  shows the modified SIGCHLD handler.

When we run `signal2` on our Linux system, it now correctly reaps all of the zombie children:

```
|  
linux> ./signal2  
Hello from child 15237  
Hello from child 15238  
Hello from child 15239  
Handler reaped child  
Handler reaped child  
Handler reaped child  
CR  
Parent processing input
```

## Practice Problem 8.8 (solution page [799](#))

What is the output of the following program?

-----

-----*code/ecf/signalprob0.c*



```

1     volatile long counter = 2;
2
3     void handler1(int sig)
4     {
5         sigset_t mask, prev_mask;
6
7         Sigfillset(&mask);
8         Sigprocmask(SIG_BLOCK, &mask,
&prev_mask); /* Block sigs */
9         Sio_putl(--counter);
10        Sigprocmask(SIG_SETMASK, &prev_mask,
NULL); /* Restore sigs */
11
12        _exit(0);
13    }
14
15    int main()
16    {
17        pid_t pid;
18        sigset_t mask, prev_mask;
19
20        printf ("%ld", counter);
21        fflush(stdout);
22
23        signal(SIGUSR1, handler1);
24        if ((pid = Fork()) == 0) {
25            while (1) ();

```

```
26     }
27     Kill(pid, SIGUSR1);
28     Waitpid(-1, NULL, 0);
29
30     Sigfillset(&mask);
31     Sigprocmask(SIG_BLOCK, &mask,
&prev_mask); /* Block sigs */
32     printf ("%ld", ++counter);
33     Sigprocmask(SIG_SETMASK, &prev_mask,
NULL); /* Restore sigs */
34
35     exit(0);
36 }
```

---

-----code/ecf/signalprob0.c

## *Portable Signal Handling*

Another ugly aspect of Unix signal handling is that different systems have different signal-handling semantics. For example:

- **The semantics of the `signal` function varies.** Some older Unix systems restore the action for signal *k* to its default after signal *k* has been caught by a handler. On these systems, the handler must explicitly reinstall itself, by calling `signal`, each time it runs.
- **System calls can be interrupted.** System calls such as `read`, `wait`, and `accept` that can potentially block the process for a long period of time are called *slow system calls*. On some older versions of Unix, slow system calls that are interrupted when a handler catches a signal do not resume when the signal handler returns but instead return immediately to the user with an error condition and `errno` set to EINTR. On these systems, programmers must include code that manually restarts interrupted system calls.

---

-----code/src/csapp.c

```
1 handler_t *Signal(int signum, handler_t *handler)
2 {
3     struct sigaction action, old_action;
4
5     action.sa_handler = handler;
6     sigemptyset(&action.sa_mask); /* Block sigs of
type being handled */
7     action.sa_flags = SA_RESTART; /* Restart
syscalls if possible */
8
9     if (sigaction(signum, &action, &old_action) <
0)
10         unix_error("Signal error");
11     return (old_action.sa_handler);
12 }
```

---

-----code/src/csapp.c

**Figure 8.38** `signal`. A wrapper for `sigaction` that provides portable signal handling on Posix-compliant systems.

To deal with these issues, the Posix standard defines the `sigaction` function, which allows users to clearly specify the signal-handling semantics they want when they install a handler.

```
|
#include <signal.h>
int sigaction(int signum, struct sigaction *act,
              struct sigaction *oldact);
Returns: 0 if OK, -1 on
error
```

The `sigaction` function is unwieldy because it requires the user to set the entries of a complicated structure. A cleaner approach, originally proposed by W. Richard Stevens [110], is to define a wrapper function, called `Signal`, that calls `sigaction` for us. **Figure 8.38** shows the definition of `Signal`, which is invoked in the same way as the `signal` function.

The `Signal` wrapper installs a signal handler with the following signal-handling semantics:

- Only signals of the type currently being processed by the handler are blocked.
- As with all signal implementations, signals are not queued.

- Interrupted system calls are automatically restarted whenever possible.
- Once the signal handler is installed, it remains installed until `signal` is called with a `handler` argument of either `SIG_IGN` or `SIG_DFL`.

We will use the `signal` wrapper in all of our code.

## 8.5.6 Synchronizing Flows to Avoid Nasty Concurrency Bugs

The problem of how to program concurrent flows that read and write the same storage locations has challenged generations of computer scientists. In general, the number of potential interleavings of the flows is exponential in the number of instructions. Some of those interleavings will produce correct answers, and others will not. The fundamental problem is to somehow *synchronize* the concurrent flows so as to allow the largest set of feasible interleavings such that each of the feasible interleavings produces a correct answer.

Concurrent programming is a deep and important problem that we will discuss in more detail in [Chapter 12](#). However, we can use what you've learned about exceptional control flow in this chapter to give you a sense of the interesting intellectual challenges associated with concurrency. For example, consider the program in Figure 8.39, which captures the structure of a typical Unix shell. The parent keeps track of its current children using entries in a global job list, with one entry per job. The `addjob` and `deletejob` functions add and remove entries from the job list.

After the parent creates a new child process, it adds the child to the job list. When the parent reaps a terminated (zombie) child in the SIGCHLD signal handler, it deletes the child from the job list.

At first glance, this code appears to be correct. Unfortunately, the following sequence of events is possible:

1. The parent executes the `fork` function and the kernel schedules the newly created child to run instead of the parent.
2. Before the parent is able to run again, the child terminates and becomes a zombie, causing the kernel to deliver a `SIGCHLD` signal to the parent.
3. Later, when the parent becomes runnable again but before it is executed, the kernel notices the pending `SIGCHLD` and causes it to be received by running the signal handler in the parent.
4. The signal handler reaps the terminated child and calls `deletejob`, which does nothing because the parent has not added the child to the list yet.
5. After the handler completes, the kernel then runs the parent, which returns from `fork` and incorrectly adds the (nonexistent) child to the job list by calling `addjob`.

Thus, for some interleavings of the parent's main routine and signal-handling flows, it is possible for `deletejob` to be called before `addjob`. This results in an incorrect entry on the job list, for a job that no longer exists and that will never be removed. On the other hand, there are also interleavings where events occur in the correct order. For example, if the kernel happens to schedule the parent to run when the `fork` call returns instead of the child, then the parent will correctly add the child to the job list before the child terminates and the signal handler removes the job from the list.



This is an example of a classic synchronization error known as a *race*. In this case, the race is between the call to `addjob` in the main routine and the call to

-----

-----code/ecf/procmask1.c

```

1      /* WARNING: This code is buggy! */
2      void handler(int sig)
3      {
4          int olderrno = errno;
5          sigset_t mask_all, prev_all;
6          pid_t pid;
7
8          Sigfillset(&mask_all);
9          while ((pid = waitpid(-1, NULL, 0)) > 0) { /*
Reap a zombie child */
10             Sigprocmask(SIG_BLOCK, &mask_all,
&prev_all);
11             deletejob(pid); /* Delete the child from
the job list */
12             Sigprocmask(SIG_SETMASK, &prev_all,
NULL);
13         }
14         if (errno != ECHILD)
15             Sio_error("waitpid error");
16         errno = olderrno;
17     }
18
19     int main(int argc, char **argv)
20     {
21         int pid;
22         sigset_t mask_all, prev_all;
23

```

```

24         Sigfillset(&mask_all);
25         Signal(SIGCHLD, handler);
26         initjobs(); /* Initialize the job list */
27
28         while (1) {
29             if ((pid = Fork()) == 0) { /* Child
process */
30                 Execve("/bin/date", argv, NULL);
31             }
32             Sigprocmask(SIG_BLOCK, &mask_all,
&prev_all); /* Parent process */
33             addjob(pid); /* Add the child to the job
list */
34             Sigprocmask(SIG_SETMASK, &prev_all,
NULL);
35         }
36         exit(0);
37     }


```

---

-----code/ecf/procmask1.c



**Figure 8.39 A shell program with a subtle synchronization error.** If the child terminates before the parent is able to run, then `addjob` and `deletejob` will be called in the wrong order.

`deletejob` in the handler. If `addjob` wins the race, then the answer is correct. If not, the answer is incorrect. Such errors are enormously difficult to debug because it is often impossible to test every interleaving. You might run the code a billion times without a problem, but then the next test results in an interleaving that triggers the race.

**Figure 8.40**  shows one way to eliminate the race in Figure 8.39. By blocking SIGCHLD signals before the call to `fork` and then unblocking them only after we have called `addjob`, we guarantee that the child will be reaped *after* it is added to the job list. Notice that children inherit the `blocked` set of their parents, so we must be careful to unblock the SIGCHLD signal in the child before calling `execve`.

## 8.5.7 Explicitly Waiting for Signals

Sometimes a main program needs to explicitly wait for a certain signal handler to run. For example, when a Linux shell creates a foreground job, it must wait for the job to terminate and be reaped by the SIGCHLD handler before accepting the next user command.

**Figure 8.41**  shows the basic idea. The parent installs handlers for SIGINT and SIGCHLD and then enters an infinite loop. It blocks SIGCHLD to avoid the race between parent and child that we discussed in **Section 8.5.6** . After creating the child, it resets `pid` to zero, unblocks SIGCHLD, and then waits in a spin loop for `pid` to become nonzero. After the child terminates, the handler reaps it and assigns its nonzero PID to the global `pid` variable. This terminates the spin loop, and the parent continues with additional work before starting the next iteration.

While this code is correct, the spin loop is wasteful of processor resources. We might be tempted to fix this by inserting a `pause` in the body of the spin loop:

```
|  
while (!pid) /* Race! */  
pause ();
```

Notice that we still need a loop because `pause` might be interrupted by the receipt of one or more SIGINT signals. However, this code has a serious race condition: if the SIGCHLD is received after the `while` test but before the `pause`, the `pause` will sleep forever.

Another option is to replace the `pause` with `sleep`:

```
|  
while (!pid) /* Too slow! */  
sleep(1);
```

While correct, this code is too slow. If the signal is received after the `while` and before the `sleep`, the program must wait a (relatively) long time before it can check the loop termination condition again. Using a higher-resolution sleep function such as `nanosleep` isn't acceptable, either, because there is no good rule for determining the sleep

interval. Make it too small and the loop is too wasteful. Make it too high and the program is too slow.



-----

-----code/ecf/procmask2.c

```

1 void handler(int sig)
2 {
3     int olderrno = errno;
4     sigset_t mask_all, prev_all;
5     pid_t pid;
6
7     Sigfillset(&mask_all);
8     while ((pid = waitpid(-1, NULL, 0)) > 0) { /*
Reap a zombie child */
9         Sigprocmask(SIG_BLOCK, &mask_all,
&prev_all);
10        deletejob(pid); /* Delete the child from
the job list */
11        Sigprocmask(SIG_SETMASK, &prev_all,
NULL);
12    }
13    if (errno != ECHILD)
14        Sio_error("waitpid error");
15    errno = olderrno;
16 }
17
18 int main(int argc, char **argv)
19 {
20     int pid;
21     sigset_t mask_all, mask_one, prev_one;
22
23     Sigfillset(&mask_all);

```

```

24         Sigemptyset(&mask_one);
25         Sigaddset(&mask_one, SIGCHLD);
26         Signal(SIGCHLD, handler);
27         initjobs(); /* Initialize the job list */
28
29         while (1) {
30             Sigprocmask(SIG_BLOCK, &mask_one,
&prev_one); /* Block SIGCHLD */
31             if ((pid = Fork()) == 0) { /* Child
process */
32                 Sigprocmask(SIG_SETMASK,
&prev_one, NULL); /* Unblock SIGCHLD */
33                 Execve("/bin/date", argv, NULL);
34             }
35             Sigprocmask(SIG_BLOCK, &mask_all, NULL);
/* Parent process */
36             addjob(pid); /* Add the child to the job
list */
37             Sigprocmask(SIG_SETMASK, &prev_one,
NULL); /* Unblock SIGCHLD */
38         }
39         exit(0);
40     }

```

---

-----code/ecf/procmask2.c

**Figure 8.40 Using `sigprocmask` to synchronize processes.**

In this example, the parent ensures that `addjob` executes before the corresponding `deletejob`.

-----

-----code/ecf/waitforsignal.c

```
|
1  #include "csapp.h"
2
3  volatile sig_atomic_t pid;
4
5  void sigchld_handler(int s)
6  {
7      int olderrno = errno;
8      pid = waitpid(-1, NULL, 0);
9      errno = olderrno;
10 }
11
12 void sigint_handler(int s)
13 {
14 }
15
16 int main(int argc, char **argv)
17 {
18     sigset_t mask, prev;
19
20     Signal(SIGCHLD, sigchld_handler);
21     Signal(SIGINT, sigint_handler);
22     Sigemptyset(&mask);
23     Sigaddset(&mask, SIGCHLD);
24
25     while (1) {
26         Sigprocmask(SIG_BLOCK, &mask, &prev); /*
```

```

Block SIGCHLD */
27         if (Fork() == 0) /* Child */
28             exit(0);
29
30         /* Parent */
31         pid = 0;
32         Sigprocmask(SIG_SETMASK, &prev, NULL);
/* Unblock SIGCHLD */
33
34         /* Wait for SIGCHLD to be received
(wasteful) */
35         while (!pid)
36             ;
37
38         /* Do some work after receiving SIGCHLD
*/
39         printf(".");
40     }
41     exit(0);
42 }

```

---

-----code/ecf/waitforsignal.c

**Figure 8.41** Waiting for a signal with a spin loop.

This code is correct, but the spin loop is wasteful.

The proper solution is to use `sigsuspend`.

```
|  
#include <signal.h>  
int sigsuspend(const sigset_t *mask);  
Returns: -1
```


The `sigsuspend` function temporarily replaces the current blocked set with `mask` and then suspends the process until the receipt of a signal whose action is either to run a handler or to terminate the process. If the action is to terminate, then the process terminates without returning from `sigsuspend`. If the action is to run a handler, then `sigsuspend` returns after the handler returns, restoring the blocked set to its state when `sigsuspend` was called.

The `sigsuspend` function is equivalent to an *atomic* (uninterruptible) version of the following:

```
|  
1 sigprocmask(SIG_BLOCK, &mask, &prev);  
2 pause();  
3 sigprocmask(SIG_SETMASK, &prev, NULL);
```



The atomic property guarantees that the calls to `sigprocmask` (line 1) and `pause` (line 2) occur together, without being interrupted. This eliminates the potential race where a signal is received after the call to `sigprocmask` and before the call to `pause`.

**Figure 8.42**  shows how we would use `sigsuspend` to replace the spin loop in Figure 8.41. Before each call to `sigsuspend`, SIGCHLD is blocked. The `sigsuspend` temporarily unblocks SIGCHLD, and then sleeps until the parent catches a signal. Before returning, it restores the original blocked set, which blocks SIGCHLD again. If the parent caught a SIGINT, then the loop test succeeds and the next iteration calls `sigsuspend` again. If the parent caught a SIGCHLD, then the loop test fails and we exit the loop. At this point, SIGCHLD is blocked, and so we can optionally unblock SIGCHLD. This might be useful in a real shell with background jobs that need to be reaped.

The `sigsuspend` version is less wasteful than the original spin loop, avoids the race introduced by `pause`, and is more efficient than `sleep`.

## 8.6 Nonlocal Jumps

C provides a form of user-level exceptional control flow, called a *nonlocal jump*, that transfers control directly from one function to another currently executing function without having to go through the normal call-and-return sequence. Nonlocal jumps are provided by the `setjmp` and `longjmp` functions.

-----

-----code/ecf/sigsuspend.c

```
|
1  #include "csapp.h"
2
3  volatile sig_atomic_t pid;
4
5  void sigchld_handler(int s)
6  {
7      int olderrno = errno;
8      pid = Waitpid(-1, NULL, 0);
9      errno = olderrno;
10 }
11
12 void sigint_handler(int s)
13 {
14 }
15
16 int main(int argc, char **argv)
17 {
18     sigset_t mask, prev;
19
20     Signal(SIGCHLD, sigchld_handler);
21     Signal(SIGINT, sigint_handler);
22     Sigemptyset(&mask);
23     Sigaddset(&mask, SIGCHLD);
24
25     while (1) {
26         Sigprocmask(SIG_BLOCK, &mask, &prev); /*
```

```

Block SIGCHLD */
27         if (Fork() == 0) /* Child */
28             exit(0);
29
30         /* Wait for SIGCHLD to be received */
31         pid = 0;
32         while (!pid)
33             sigsuspend(&prev);
34
35         /* Optionally unblock SIGCHLD */
36         Sigprocmask(SIG_SETMASK, &prev, NULL);
37
38         /* Do some work after receiving SIGCHLD
*/
39         printf (".");
40     }
41     exit(0);
42 }

```

---

-----code/ecf/sigsuspend.c

**Figure 8.42** Waiting for a signal with `sigsuspend`.

```
|  
#include <setjmp.h>  
int setjmp(jmp_buf env);  
int sigsetjmp(sigjmp_buf env, int savesigs);  
Returns: 0 from set jmp, nonzero  
from longjumps
```

The `setjmp` function saves the current *calling environment* in the `env` buffer, for later use by `longjmp`, and returns 0. The calling environment includes the program counter, stack pointer, and general-purpose registers. For subtle reasons beyond our scope, the value that `setjmp` returns should not be assigned to a variable:

```
rc = setjmp(env); /* Wrong! */
```


However, it can be safely used as a test in a `switch` or conditional statement [62].

```
|  
#include <setjmp.h>  
void longjmp(jmp_buf env, int retval);  
void siglongjmp(sigjmp_buf env, int retval);  
Never returns
```

The `longjmp` function restores the calling environment from the `env` buffer and then triggers a return from the most recent `setjmp` call that initialized `env`. The `setjmp` then returns with the nonzero return value `retval`.

The interactions between `setjmp` and `longjmp` can be confusing at first glance. The `setjmp` function is called once but returns *multiple times*: once when the `setjmp` is first called and the calling environment is stored in the `env` buffer, and once for each corresponding `longjmp` call. On the other hand, the `longjmp` function is called once but never returns.

An important application of nonlocal jumps is to permit an immediate return from a deeply nested function call, usually as a result of detecting some error condition. If an error condition is detected deep in a nested function call, we can use a nonlocal jump to return directly to a common localized error handler instead of laboriously unwinding the call stack.

**Figure 8.43**  shows an example of how this might work. The `main` routine first calls `setjmp` to save the current calling environment, and then calls function `foo`, which in turn calls function `bar`. If `foo` or `bar` encounter an error, they return immediately from the `setjmp` via a `longjmp` call. The nonzero return value of the `setjmp` indicates the error type, which can then be decoded and handled in one place in the code.

The feature of `longjmp` that allows it to skip up through all intermediate calls can have unintended consequences. For example, if some data structures were allocated in the intermediate function calls with the intention to deallocate them at the end of the function, the deallocation code gets skipped, thus creating a memory leak.



-----

-----code/ecf/setjmp.c

```
|
1  #include "csapp.h"
2
3  jmp_buf buf;
4
5  int error1 = 0;
6  int error2 = 1;
7
8  void foo(void), bar(void);
9
10 int main()
11 {
12     switch(setjmp(buf)) {
13         case 0:
14             foo();
15             break;
16         case 1:
17             printf("Detected an error1 condition in
18 foo\n");
19             break;
20         case 2:
21             printf("Detected an error2 condition in
22 foo\n");
23             break;
24         default:
25             printf("Unknown error condition in
26 foo\n");
```

```
24     }
25     exit(0);
26 }
27
28 /* Deeply nested function foo */
29 void foo(void)
30 {
31     if (error1)
32         longjmp(buf, 1);
33     bar();
34 }
35
36 void bar(void)
37 {
38     if (error2)
39         longjmp(buf, 2);
40 }
```

---

-----code/ecf/setjmp.c

### Figure 8.43 Nonlocal jump example.

This example shows the framework for using nonlocal jumps to recover from error conditions in deeply nested functions without having to unwind the entire stack.

-----


-----code/ecf/restart.c

```
|
1  #include "csapp.h"
2
3  sigjmp_buf buf;
4
5  void handler(int sig)
6  {
7      siglongjmp(buf, 1);
8  }
9
10 int main()
11 {
12     if (!sigsetjmp(buf, 1)) {
13         Signal(SIGINT, handler);
14         Sio_puts("starting\n");
15     }
16     else
17         Sio_puts("restarting\n");
18
19     while(1) {
20         Sleep (1);
21         Sio_puts("processing...\n");
22     }
23     exit(0); /* Control never reaches here */
24 }
```

---

-----code/ecf/restart.c

**Figure 8.44 A program that uses nonlocal jumps to restart itself when the user types Ctrl+C.**

Another important application of nonlocal jumps is to branch out of a signal handler to a specific code location, rather than returning to the instruction that was interrupted by the arrival of the signal. **Figure 8.44**  shows a simple program that illustrates this basic technique. The program uses signals and nonlocal jumps to do a soft restart whenever the user types Ctrl+C at the keyboard. The `sigsetjmp` and `siglongjmp` functions are versions of `setjmp` and `longjmp` that can be used by signal handlers.

The initial call to the `sigsetjmp` function saves the calling environment and signal context (including the pending and blocked signal vectors) when the program first starts. The main routine then enters an infinite processing loop. When the user types Ctrl+C, the kernel sends a SIGINT signal to the process, which catches it. Instead of returning from the signal handler, which would pass control back to the interrupted processing loop, the handler performs a nonlocal jump back to the beginning of the `main` program. When we run the program on our system, we get the following output:

# Aside Software exceptions in C++ and Java

The exception mechanisms provided by C++ and Java are higher-level, more structured versions of the C `setjmp` and `longjmp` functions. You can think of a `catch` clause inside a `try` statement as being akin to a `setjmp` function. Similarly, a `throw` statement is similar to a `longjmp` function.

```
|  
linux> ./restart  
starting  
processing...  
processing...  
Ctrl+C  
restarting  
processing...  
Ctrl+C  
restarting  
processing...
```

There a couple of interesting things about this program. First, To avoid a race, we must install the handler *after* we call `sigsetjmp`. If not, we would run the risk of the handler running before the initial call

to `sigsetjmp` sets up the calling environment for `siglongjmp`. Second, you might have noticed that the `sigsetjmp` and `siglongjmp` functions are not on the list of async-signal-safe functions in Figure 8.33. The reason is that in general `siglongjmp` can jump into arbitrary code, so we must be careful to call only safe functions in any code reachable from a `siglongjmp`. In our example, we call the safe `sio_puts` and `sleep` functions. The unsafe `exit` function is unreachable.

[OceanofPDF.com](http://OceanofPDF.com)



# 8.7 Tools for Manipulating Processes

Linux systems provide a number of useful tools for monitoring and manipulating processes:

`STRACE`. Prints a trace of each system call invoked by a running program and its children. It is a fascinating tool for the curious student. Compile your program with `-static` to get a cleaner trace without a lot of output related to shared libraries.

`PS`. Lists processes (including zombies) currently in the system.

`TOP`. Prints information about the resource usage of current processes.

`PMAP`. Displays the memory map of a process.

`/proc`. A virtual filesystem that exports the contents of numerous kernel data structures in an ASCII text form that can be read by user programs. For example, type `cat /proc/loadavg` to see the current load average on your Linux system.

## 8.8 Summary

Exceptional control flow (ECF) occurs at all levels of a computer system and is a basic mechanism for providing concurrency in a computer system.

At the hardware level, exceptions are abrupt changes in the control flow that are triggered by events in the processor. The control flow passes to a software handler, which does some processing and then returns control to the interrupted control flow.

There are four different types of exceptions: interrupts, faults, aborts, and traps. Interrupts occur asynchronously (with respect to any instructions) when an external I/O device such as a timer chip or a disk controller sets the interrupt pin on the processor chip. Control returns to the instruction following the faulting instruction. Faults and aborts occur synchronously as the result of the execution of an instruction. Fault handlers restart the faulting instruction, while abort handlers never return control to the interrupted flow. Finally, traps are like function calls that are used to implement the system calls that provide applications with controlled entry points into the operating system code.

At the operating system level, the kernel uses ECF to provide the fundamental notion of a process. A process provides applications with two important abstractions: (1) logical control flows that give

each program the illusion that it has exclusive use of the processor, and (2) private address spaces that provide the illusion that each program has exclusive use of the main memory.

At the interface between the operating system and applications, applications can create child processes, wait for their child processes to stop or terminate, run new programs, and catch signals from other processes. The semantics of signal handling is subtle and can vary from system to system. However, mechanisms exist on Posix-compliant systems that allow programs to clearly specify the expected signal-handling semantics.

Finally, at the application level, C programs can use nonlocal jumps to bypass the normal call/return stack discipline and branch directly from one function to another.

[OceanofPDF.com](http://OceanofPDF.com)

# Bibliographic Notes

Kerrisk is the essential reference for all aspects of programming in the Linux environment [62]. The Intel ISA specification contains a detailed discussion of exceptions and interrupts on Intel processors [50]. Operating systems texts [102, 106, 113] contain additional information on exceptions, processes, and signals. The classic work by W. Richard Stevens [111] is a valuable and highly readable description of how to work with processes and signals from application programs. Bovet and Cesati [11] give a wonderfully clear description of the Linux kernel, including details of the process and signal implementations.

[OceanofPDF.com](http://OceanofPDF.com)

# Homework Problems

## 8.9 ♦

Consider four processes with the following starting and ending times:

For each pair of processes, indicate whether they run concurrently (Y) or not (N):

## 8.10 ♦

In this chapter, we have introduced some functions with unusual call and return behaviors: `setjmp`, `longjmp`, `execve`, and `fork`. Match each function with one of the following behaviors:

- A. Called once, returns twice
- B. Called once, never returns
- C. Called once, returns one or more times

## 8.11 ♦

How many “hello” output lines does this program print?

-----code/ecf/forkprob1.c

```
|  
1 #include "csapp.h"  
2  
3 int main()  
4 {  
5     int i;  
6  
7     for (i = 0; i < 2; i++)  
8         Fork();  
9     printf("hello\n");  
10    exit(0);  
11 }
```

-----code/ecf/forkprob1.c

## 8.12 ♦

How many “hello” output lines does this program print?

---

-----code/ecf/forkprob4.c

```
|
1  #include "csapp.h"
2
3  void doit()
4  {
5      Fork();
6      Fork();
7      printf("hello\n");
8      return;
9  }
10
11 int main()
12 {
13     doit();
14     printf("hello\n");
15     exit(0);
16 }
```

-----

-----code/ecf/forkprob4.c



## 8.13 ♦

What is one possible output of the following program?

-----code/ecf/forkprob3.c

```
|  
1     #include "csapp.h"  
2  
3     int main()  
4  
5         int x = 3;  
6  
7         if (Fork() != 0)  
8             printf ("x=%d\n", ++x);  
9  
10        printf ("x=%d\n", --x);  
11        exit(0);  
12    }
```

-----code/ecf/forkprob3.c

## 8.14 ♦

How many “hello” output lines does this program print?

---

-----code/ecf/forkprob5.c

```
|
1  #include "csapp.h"
2
3  void doit()
4  {
5      if (Fork() == 0) {
6          Fork();
7          printf("hello\n");
8          exit(0);
9      }
10     return;
11 }
12
13 int main()
14 {
15     doit();
16     printf("hello\n");
17     exit(0);
18 }
```

-----

-----code/ecf/forkprob5.c

## 8.15 ♦

How many “hello” lines does this program print?

---

-----code/ecf/forkprob6.c

```
|
1  #include "csapp.h"
2
3  void doit()
4  {
5      if (Fork() == 0) {
6          Fork();
7          printf("hello\n");
8          return;
9      }
10     return;
11 }
12
13 int main()
14 {
15     doit();
16     printf("hello\n");
17     exit(0);
18 }
```

-----

-----code/ecf/forkprob6.c

## 8.16 ♦

What is the output of the following program?


---

-----code/ecf/forkprob7.c

```
|
1  #include "csapp.h"
2  int counter = 1;
3
4  int main()
5  {
6      if (fork() == 0) {
7          counter--;
8          exit(0);
9      }
10     else {
11         wait(NULL);
12         printf("counter = %d\n",
13 ++counter);
14     }
15     exit(0);
16 }
```

-----  
-----code/ecf/forkprob7.c

## 8.17 ♦

Enumerate all of the possible outputs of the program in  
Practice [Problem 8.4](#) .

## 8.18 ♦♦

Consider the following program:

-----code/ecf/forkprob2.c

```
|
1  #include "csapp.h"
2
3  void end(void)
4  {
5      printf("2"); fflush(stdout);
6  }
7
8  int main()
9  {
10     if (Fork() == 0)
11         atexit(end);
12     if (Fork() == 0) {
13         printf("0"); fflush(stdout);
14     }
15     else {
16         printf("1"); fflush(stdout);
17     }
18     exit(0);
19 }
```



-----  
-----code/ecf/forkprob2.c

Determine which of the following outputs are possible. **Note:** The `atexit` function takes a pointer to a function and adds it to a list of functions (initially empty) that will be called when the `exit` function is called.

- A. 112002
- B. 211020
- C. 102120
- D. 122001
- E. 100212

## 8.19 ♦♦

How many lines of output does the following function print?  
Give your answer as a function of  $n$ . Assume  $n \geq 1$ .

-----

-----code/ecf/forkprob8.c

```
|  
1 void foo(int n)  
2 {  
3     int i;  
4  
5     for (i = 0; i < n; i++)  
6         Fork();  
7     printf("hello\n");  
8     exit(0);  
9 }
```

-----

-----code/ecf/forkprob8.c

## 8.20 ♦♦

Use `execve` to write a program called `myls` whose behavior is identical to the `/bin/ls` program. Your program should accept the same command-line arguments, interpret the identical environment variables, and produce the identical output. The `ls` program gets the width of the screen from the `COLUMNS` environment variable. If `COLUMNS` is unset, then `ls` assumes that the screen is 80 columns wide. Thus, you can check your handling of the environment variables by setting the `COLUMNS` environment to something less than 80:

```
linux> setenv COLUMNS 40
linux> ./mys
: // Output is 40 columns wide
linux> unsetenv COLUMNS
linux> ./mys
: // Output is now 80 columns wide
```

## 8.21 ♦♦

What are the possible output sequences from the following program?

-----  
-----code/ecf/waitprob3.c

```
|  
1     int main()  
2     {  
3         if (fork() == 0) {  
4             printf("a"); fflush(stdout);  
5             exit(0);  
6         }  
7         else {  
8             printf("b"); fflush(stdout);  
9             waitpid(-1, NULL, 0);  
10        }  
11        printf("c"); fflush(stdout);  
12        exit(0);  
13    }
```

-----  
-----code/ecf/waitprob3.c


## 8.22 ◆◆◆

Write your own version of the Unix `system` function

```
int mysystem(char *command);
```

The `mysystem` function executes `command` by invoking `/bin/sh -c command`, and then returns after `command` has completed. If `command` exits normally (by calling the `exit` function or executing a `return` statement), then `mysystem` returns the `command` exit status. For example, if `command` terminates by calling `exit (8)`, then `mysystem` returns the value 8. Otherwise, if `command` terminates abnormally, then `mysystem` returns the status returned by the shell.

## 8.23 ♦♦

One of your colleagues is thinking of using signals to allow a parent process to count events that occur in a child process. The idea is to notify the parent each time an event occurs by sending it a signal and letting the parent's signal handler increment a global `counter` variable, which the parent can then inspect after the child has terminated. However, when he runs the test program in [Figure 8.45](#)  on his system, he discovers that when the parent calls `printf, counter` always has a value of 2, even though the child has sent five signals to the parent. Perplexed, he comes to you for help. Can you explain the bug?

## 8.24 ◆◆◆

Modify the program in [Figure 8.18](#) so that the following two conditions are met:

1. Each child terminates abnormally after attempting to write to a location in the read-only text segment.
2. The parent prints output that is identical (except for the PIDs) to the following:

```
|  
child 12255 terminated by signal 11: Segmentation fault  
child 12254 terminated by signal 11: Segmentation fault
```

**Hint:** Read the `man` page for `psignal` (3).

-----



-----code/ecf/counterprob.c



```
|
1  #include "csapp.h"
2
3  int counter = 0;
4
5  void handler(int sig)
6  {
7      counter++;
8      sleep(1); /* Do some work in the handler
*/
9      return;
10 }
11
12 int main()
13 {
14     int i;
15
16     signal(SIGUSR2, handler);
17
18     if (fork() == 0) { /* Child */
19         for (i = 0; i < 5; i++) {
20             kill(getppid(), SIGUSR2);
21             printf("sent SIGUSR2 to
parent\n");
22         }
23         exit(0);
24     }
```

```
25
26     wait (NULL);
27     printf("counter=%d\n", counter);
28     exit(0);
29 }
```


-----  
-----code/ecf/counterprob.c

**Figure 8.45**  Counter program referenced in **Problem 8.23** .

## 8.25

Write a version of the `fgets` function, called `tfgets`, that times out after 5 seconds. The `tfgets` function accepts the same inputs as `fgets`. If the user doesn't type an input line within 5 seconds, `tfgets` returns NULL. Otherwise, it returns a pointer to the input line.

## 8.26 ◆◆◆◆

Using the example in [Figure 8.23](#)  as a starting point, write a shell program that supports job control. Your shell should have the following features:

- The command line typed by the user consists of a `name` and zero or more arguments, all separated by one or more spaces. If `name` is a built-in command, the shell handles it immediately and waits for the next command line. Otherwise, the shell assumes that `name` is an executable file, which it loads and runs in the context of an initial child process (job). The process group ID for the job is identical to the PID of the child.
- Each job is identified by either a process ID (PID) or a job ID (JID), which is a small arbitrary positive integer assigned by the shell. JIDs are denoted on the command line by the prefix '%'. For example, '%5' denotes JID 5, and '5' denotes PID 5.
- If the command line ends with an ampersand, then the shell runs the job in the background. Otherwise, the shell runs the job in the foreground.
- Typing Ctrl+C (Ctrl+Z) causes the kernel to send a SIGINT (SIGTSTP) signal to your shell, which then forwards it to every process in the foreground process group.<sup>2</sup>

2. Note that this is a simplification of the way that real shells work. With real shells, the kernel responds to Ctrl+C (Ctrl+Z) by sending SIGINT (SIGTSTP) directly to each process in the terminal foreground process group. The shell manages the membership of this group using the `tcsetpgrp` function, and manages the attributes of the terminal using the `tcsetattr` function, both of which are outside the scope of this book. See [62] for details.

- The `jobs` built-in command lists all background jobs.
- The `bg job` built-in command restarts *job* by sending it a SIGCONT signal and then runs it in the background. The *job* argument can be either a PID or a JID.
- The `fg job` built-in command restarts *job* by sending it a SIGCONT signal and then runs it in the foreground.
- The shell reaps all of its zombie children. If any job terminates because it receives a signal that was not caught, then the shell prints a message to the terminal with the job's PID and a description of the offending signal.

**Figure 8.46**  shows an example shell session.

[OceanofPDF.com](http://OceanofPDF.com)

# Solutions to Practice Problems

## **Solution to Problem 8.1** (page 734)

Processes A and B are concurrent with respect to each other, as are B and C, because their respective executions overlap—that is, one process starts before the other finishes. Processes A and C are not concurrent because their executions do not overlap; A finishes before C begins.

## Solution to Problem 8.2 (page 743)

In our example program in Figure 8.15, the parent and child execute disjoint sets of instructions. However, in this program, the parent and child execute nondisjoint sets of instructions, which is possible because the parent and child have identical code segments. This can be a difficult conceptual hurdle, so be sure you understand the solution to this problem. [Figure 8.47 !\[\]\(d0a1791f26d167e866e44ebbf83efebe\_img.jpg\)](#) shows the process graph.

```
linux> ./shell
```

```
Run your shell
```

```
program
```

```
>bogus
```

```
bogus: Command not found.
```

```
Execve can't
```

```
find executable
```

```
>foo 10
```

```
Job 5035 terminated by signal: Interrupt
```

```
User types
```

```
Ctrl+C
```

```
>foo 100 &
```

```
[1] 5036 foo 100 &
```

```
>foo 200 &
```

```
[2] 5037 foo 200 &
```

```
>jobs
```

```
[1] 5036 Running foo 100 &
```

```
[2] 5037 Running foo 200 &
```

```
>fg %1
```

```
Job [1] 5036 stopped by signal: Stopped
```

```
User types
```

```
Ctrl+Z
```

```
>jobs
```

```
[1] 5036 Stopped foo 100 &
```

```
[2] 5037 Running foo 200 &
```

```
>bg 5035
```

```
5035: No such process
```

```
>bg 5036
```

```
[1] 5036 foo 100 &
```

```
>/bin/kill 5036
```

```

Job 5036 terminated by signal: Terminated
> fg %2                                Wait for fg job
to finish
>quit
linux>                                  Back to the Unix
shell

```

Figure 8.46 Sample shell session for [Problem 8.26](#).

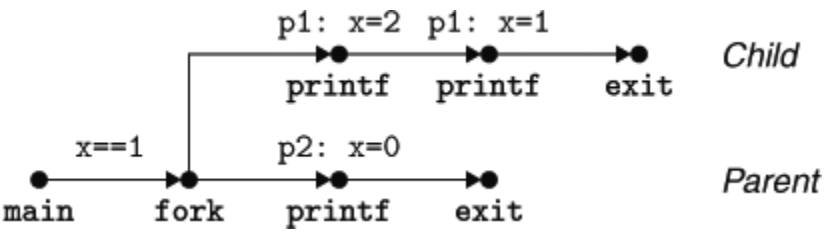


Figure 8.47 Process graph for Practice [Problem 8.2](#).

A. The key idea here is that the child executes both `printf` statements. After the `fork` returns, it executes the `printf` in line 6. Then it falls out of the `if` statement and executes the `printf` in line 7. Here is the output produced by the child:

```

|
p1: x=2
p2: x=1

```



B. The parent executes only the `printf` in line 7:

```
p2: x=0
```

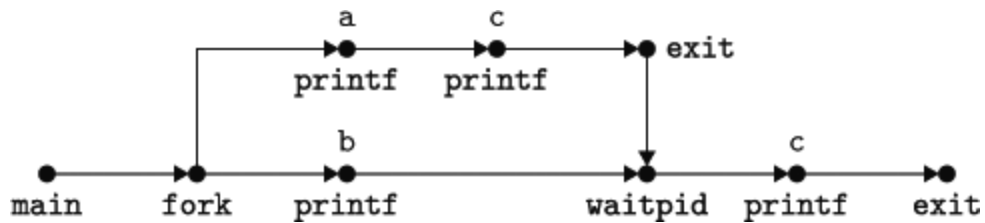


Figure 8.48 Process graph for Practice [Problem 8.3](#).

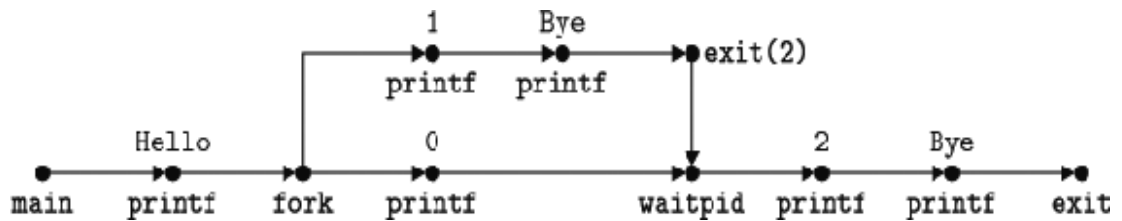



Figure 8.49 Process graph for Practice [Problem 8.4](#).

## Solution to Problem 8.3 (page 745)

We know that the sequences *acbc*, *abcc*, and *bacc* are possible because they correspond to topological sorts of the process graph (Figure 8.48). However, sequences such as *bcac* and *cbca* do not correspond to any topological sort and thus are not feasible.

## Solution to Problem 8.4 (page 748)

- A. We can determine the number of lines of output by simply counting the number of `printf` vertices in the process graph (**Figure 8.49** ). In this case, there are six such vertices, and thus the program will print six lines of output.
- B. Any output sequence corresponding to a topological sort of the graph is possible. For example: `Hello, 1, 0, Bye, 2, Bye` is possible.

# Solution to Problem 8.5 (page 750)

---

-----code/ecf/snooze.c

```
|
1 unsigned int snooze(unsigned int secs) {
2 unsigned int rc = sleep(secs);
3
4 printf("Slept for %d of %d secs.\n", secs-rc, secs);
5 return rc;
6 }
```

---

-----code/ecf/snooze.c

# Solution to Problem 8.6 [↗](#)(page 752)

---

-----[code/ecf/myecho.c](#)

```
|
1  #include "csapp.h"
2
3  int main (int argc, char *argv[], char *envp [])
4  {
5      int i;
6
7      printf("Command-line arguments:\n");
8      for (i=0; argv[i] != NULL; i++)
9          printf(" argv[%2d]: %s\n", i, argv[i]);
10
11     printf("\n");
12     printf("Environment variables:\n");
13     for (i=0; envp[i] != NULL; i++)
14         printf (" envp[%2d]: %s\n", i, envp[i]);
15
16     exit(0);
17 }
```

---

-----code/ecf/myecho.c

## Solution to Problem 8.7 (page 764)

The `sleep` function returns prematurely whenever the sleeping process receives a signal that is not ignored. But since the default action upon receipt of a SIGINT is to terminate the process (Figure 8.26), we must install a SIGINT handler to allow the `sleep` function to return. The handler simply catches the SIGNAL and returns control to the `sleep` function, which returns immediately.

-----

-----*code/ecf/snooze.c*

```

1  #include "csapp.h"
2
3  /* SIGINT handler */
4  void handler(int sig)
5  {
6      return; /* Catch the signal and return */
7  }
8
9  unsigned int snooze(unsigned int secs) {
10     unsigned int rc = sleep(secs);
11
12     printf ("Slept for %d of %d secs.\n", secs-rc,
13     sees);
14     return rc;
15 }
16 int main(int argc, char **argv) {
17
18     if (argc != 2) {
19         fprintf (stderr, "usage: %s <secs>\n",
20     argv[0]);
21         exit(0);
22
23     if (signal(SIGINT, handler) == SIG_ERR) /*
Install SIGINT */

```

```
24         unix_error("signal error\n"); /* handler
*/
25         (void) snooze (atoi (argv [1]));
26         exit(0);
27     }
```

---

-----code/ecf/snooze.c

## Solution to Problem 8.8 (page 773)


This program prints the string 213, which is the shorthand name of the CS:APP course at Carnegie Mellon. The parent starts by printing '2', then `fork`s the child, which spins in an infinite loop. The parent then sends a signal to the child and waits for it to terminate. The child catches the signal (interrupting the infinite loop), decrements the counter (from an initial value of 2), prints '1', and then terminates. After the parent reaps the child, it increments the counter (from an initial value of 2), prints '3', and terminates.



---

# Chapter 9 Virtual Memory

---

- 9.1 Physical and Virtual Addressing 803 
- 9.2 Address Spaces 804 
- 9.3 VM as a Tool for Caching 805 
- 9.4 VM as a Tool for Memory Management 811 
- 9.5 VM as a Tool for Memory Protection 812 
- 9.6 Address Translation 813 
- 9.7 Case Study: The Intel Core i7/Linux Memory System 825 
- 9.8 Memory Mapping 833 
- 9.9 Dynamic Memory Allocation 839 
- 9.10 Garbage Collection 865 
- 9.11 Common Memory-Related Bugs in C Programs 870 
- 9.12 Summary 875 
- Bibliographic Notes 876 
- Homework Problems 876 
- Solutions to Practice Problems 880 

*Processes in a system share the CPU and main memory with other processes. However, sharing the main memory poses some special challenges. As demand on the CPU increases, processes slow down in some reasonably smooth way. But if too many processes need too much memory, then some of them will simply not be able to run. When a program is out of space, it is out of luck. Memory is also vulnerable to corruption. If some process inadvertently writes to the memory used by another process, that process might fail in some bewildering fashion totally unrelated to the program logic.*

*In order to manage memory more efficiently and with fewer errors, modern systems provide an abstraction of main memory known as virtual memory (VM). Virtual memory is an elegant interaction of hardware exceptions, hardware address translation, main memory, disk files, and kernel software that provides each process with a large, uniform, and private address space. With one clean mechanism, virtual memory provides three important capabilities: (1) It uses main memory efficiently by treating it as a cache for an address space stored on disk, keeping only the active areas in main memory and transferring data back and forth between*

*disk and memory as needed. (2) It simplifies memory management by providing each process with a uniform address space. (3) It protects the address space of each process from corruption by other processes.*

*Virtual memory is one of the great ideas in computer systems. A major reason for its success is that it works silently and automatically, without any intervention from the application programmer. Since virtual memory works so well behind the scenes, why would a programmer need to understand it? There are several reasons.*

- ***Virtual memory is central.*** *Virtual memory pervades all levels of computer systems, playing key roles in the design of hardware exceptions, assemblers, linkers, loaders, shared objects, files, and processes. Understanding virtual memory will help you better understand how systems work in general.*
- ***Virtual memory is powerful.*** *Virtual memory gives applications powerful capabilities to create and destroy chunks of memory, map chunks of memory to portions*

*of disk files, and share memory with other processes. For example, did you know that you can read or modify the contents of a disk file by reading and writing memory locations? Or that you can load the contents of a file into memory without doing any explicit copying? Understanding virtual memory will help you harness its powerful capabilities in your applications.*


- ***Virtual memory is dangerous.*** *Applications interact with virtual memory every time they reference a variable, dereference a pointer, or make a call to a dynamic allocation package such as `malloc`. If virtual memory is used improperly, applications can suffer from perplexing and insidious memory-related bugs. For example, a program with a bad pointer can crash immediately with a "segmentation fault" or a "protection fault," run silently for hours before crashing, or scariest of all, run to completion with incorrect results. Understanding virtual memory, and the allocation packages such as `malloc` that manage it, can help you avoid these errors.*


*This chapter looks at virtual memory from two angles. The first half of the chapter describes*

*how virtual memory works. The second half describes how virtual memory is used and managed by applications. There is no avoiding the fact that VM is complicated, and the discussion reflects this in places. The good news is that if you work through the details, you will be able to simulate the virtual memory mechanism of a small system by hand, and the virtual memory idea will be forever demystified.*

*The second half builds on this understanding, showing you how to use and manage virtual memory in your programs. You will learn how to manage virtual memory via explicit memory mapping and calls to dynamic storage allocators such as the `malloc` package. You will also learn about a host of common memory-related errors in C programs and how to avoid them.*

# 9.1 Physical and Virtual Addressing

The main memory of a computer system is organized as an array of  $M$  contiguous byte-size cells. Each byte has a unique *physical address (PA)*. The first byte has an address of 0, the next byte an address of 1, the next byte an address of 2, and so on. Given this simple organization, the most natural way for a CPU to access memory would be to use physical addresses. We call this approach *physical addressing*. **Figure 9.1**  shows an example of physical addressing in the context of a load instruction that reads the 4-byte word starting at physical address 4. When the CPU executes the load instruction, it generates an effective physical address and passes it to main memory over the memory bus. The main memory fetches the 4-byte word starting at physical address 4 and returns it to the CPU, which stores it in a register.

Early PCs used physical addressing, and systems such as digital signal processors, embedded microcontrollers, and Cray supercomputers continue to do so. However, modern processors use a form of addressing known as *virtual addressing*, as shown in **Figure 9.2** .

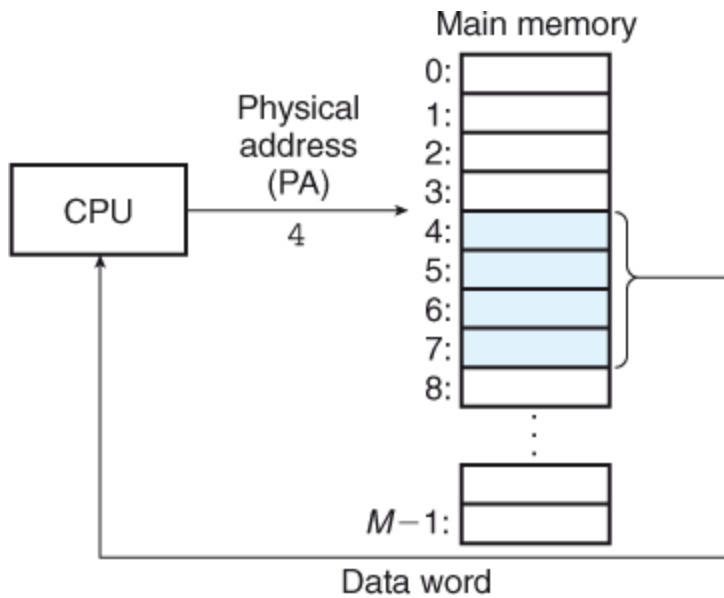


Figure 9.1 A system that uses physical addressing.

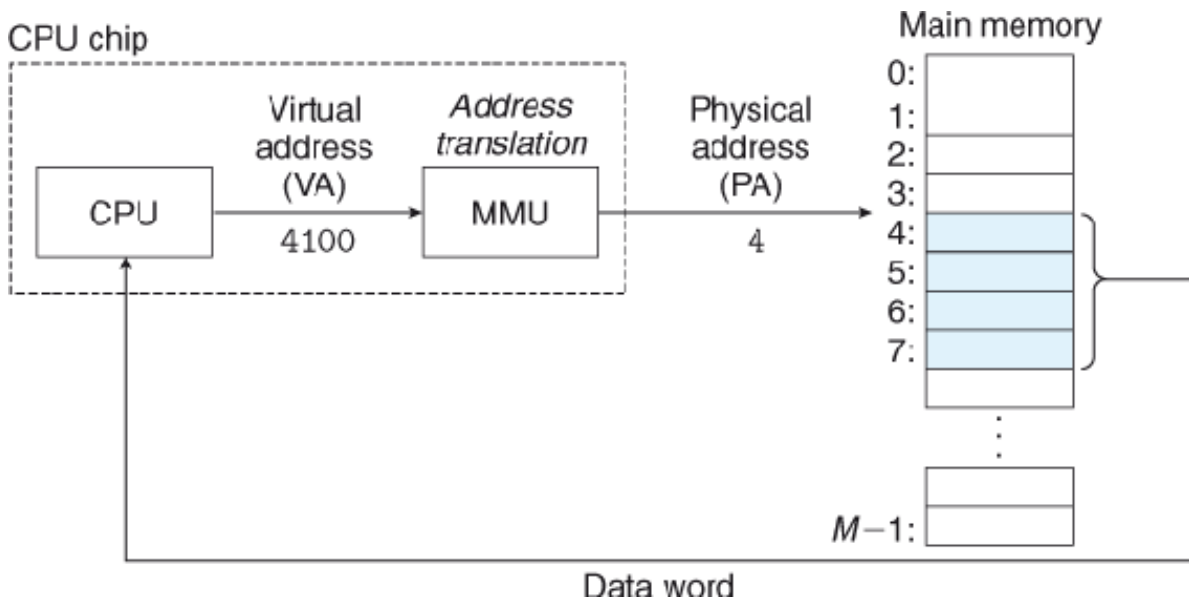


Figure 9.2 A system that uses virtual addressing.

With virtual addressing, the CPU accesses main memory by generating a *virtual address (VA)*, which is converted to the appropriate physical address before being sent to main memory. The



task of converting a virtual address to a physical one is known as *address translation*. Like exception handling, address translation requires close cooperation between the CPU hardware and the operating system. Dedicated hardware on the CPU chip called the *memory management unit (MMU)* translates virtual addresses on the fly, using a lookup table stored in main memory whose contents are managed by the operating system.

[OceanofPDF.com](http://OceanofPDF.com)

## 9.2 Address Spaces

An *address space* is an ordered set of nonnegative integer addresses

$$\{0, 1, 2, \dots\}$$

If the integers in the address space are consecutive, then we say that it is a *linear address space*. To simplify our discussion, we will always assume linear address spaces. In a system with virtual memory, the CPU generates virtual addresses from an address space of  $N = 2^n$  addresses called the *virtual address space*:

$$\{0, 1, 2, \dots, N - 1\}$$

The size of an address space is characterized by the number of bits that are needed to represent the largest address. For example, a virtual address space with  $N = 2^n$  addresses is called an  $n$ -bit address space. Modern systems typically support either 32-bit or 64-bit virtual address spaces.

A system also has a *physical address space* that corresponds to the  $M$  bytes of physical memory in the system:

$$\{0, 1, 2, \dots, M - 1\}$$

$M$  is not required to be a power of 2, but to simplify the discussion, we will assume that  $M = 2^m$ .

The concept of an address space is important because it makes a clean distinction between data objects (bytes) and their attributes (addresses). Once we recognize this distinction, then we can generalize and allow each data object to have multiple independent addresses, each chosen from a different address space. This is the basic idea of virtual memory. Each byte of main memory has a virtual address chosen from the virtual address space, and a physical address chosen from the physical address space.

## Practice Problem 9.1 (solution page **880**)

Complete the following table, filling in the missing entries and replacing each question mark with the appropriate integer.

Use the following units: K =  $2^{10}$  (kilo), M =  $2^{20}$  (mega), G =  $2^{30}$  (giga), T =  $2^{40}$  (tera), P =  $2^{50}$  (peta), or E =  $2^{60}$  (exa).

[OceanofPDF.com](http://OceanofPDF.com)

## 9.3 VM as a Tool for Caching

Conceptually, a virtual memory is organized as an array of  $N$  contiguous byte-size cells stored on disk. Each byte has a unique virtual address that serves as an index into the array. The contents of the array on disk are cached in main memory. As with any other cache in the memory hierarchy, the data on disk (the lower level) is partitioned into blocks that serve as the transfer units between the disk and the main memory (the upper level). VM systems handle this by partitioning the virtual memory into fixed-size blocks called *virtual pages (VPs)*. Each virtual page is  $P = 2^p$  bytes in size. Similarly, physical memory is partitioned into *physical pages (PPs)*, also  $P$  bytes in size. (Physical pages are also referred to as *page frames*.)

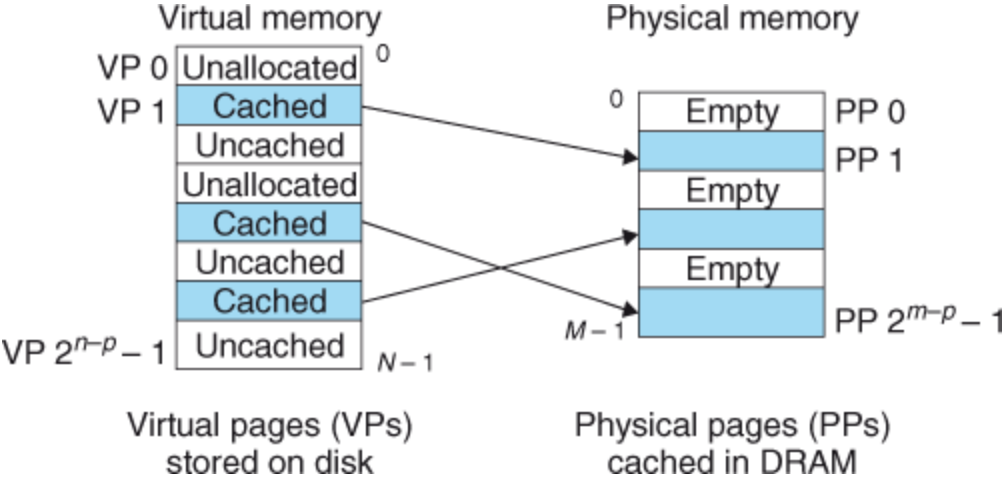
At any point in time, the set of virtual pages is partitioned into three disjoint subsets:

**Unallocated.** Pages that have not yet been allocated (or created) by the VM system. Unallocated blocks do not have any data associated with them, and thus do not occupy any space on disk.

**Cached.** Allocated pages that are currently cached in physical memory.

**Uncached.** Allocated pages that are not cached in physical memory.

The example in [Figure 9.3](#) shows a small virtual memory with eight virtual pages. Virtual pages 0 and 3 have not been allocated yet, and thus do not yet exist



**Figure 9.3** How a VM system uses main memory as a cache.

on disk. Virtual pages 1,4, and 6 are cached in physical memory. Pages 2,5, and 7 are allocated but are not currently cached in physical memory.

## 9.3.1 DRAM Cache Organization

To help us keep the different caches in the memory hierarchy straight, we will use the term *SRAM cache* to denote the L1, L2, and L3 cache memories between the CPU and main memory, and the term *DRAM cache* to denote the VM system's cache that caches virtual pages in main memory.

The position of the DRAM cache in the memory hierarchy has a big impact on the way that it is organized. Recall that a DRAM is at least 10 times slower than an SRAM and that disk is about 100,000 times slower than a DRAM. Thus, misses in DRAM caches are very expensive compared to misses in SRAM caches because DRAM cache misses are served from disk, while SRAM cache misses are usually served from DRAM-based main memory. Further, the cost of reading the first byte from a disk sector is about 100,000 times slower than reading successive bytes in the sector. The bottom line is that the organization of the DRAM cache is driven entirely by the enormous cost of misses.

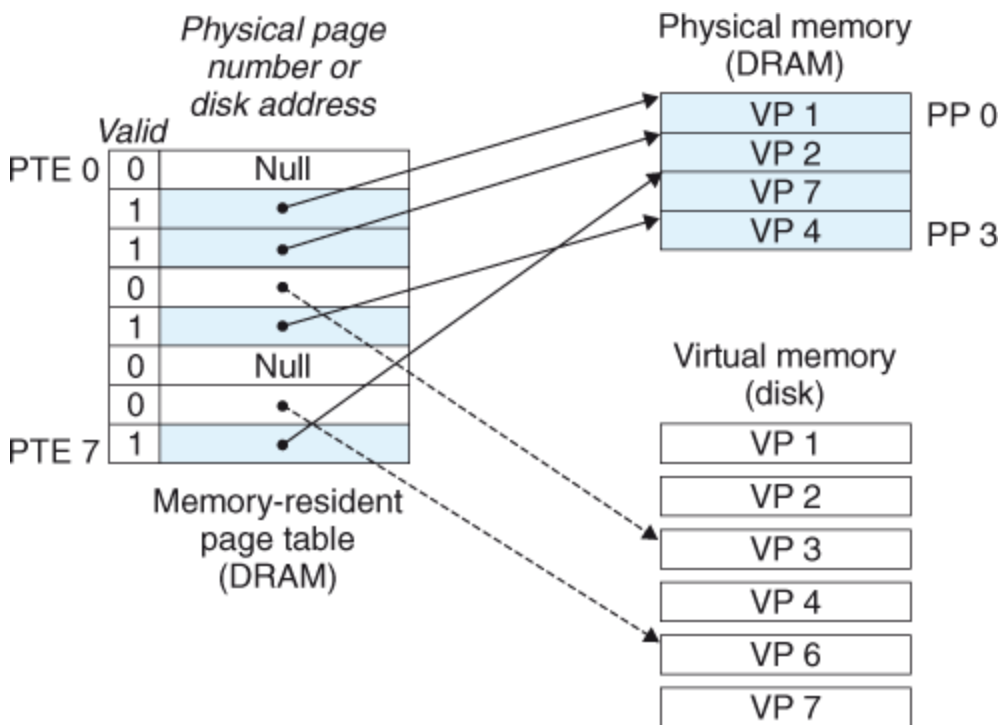
Because of the large miss penalty and the expense of accessing the first byte, virtual pages tend to be large—typically 4 KB to 2 MB. Due to the large miss penalty, DRAM caches are fully associative; that is, any virtual page can be placed in any physical page. The replacement policy on misses also assumes greater importance, because the penalty associated with replacing the wrong virtual page is so high. Thus, operating systems use much more sophisticated

replacement algorithms for DRAM caches than the hardware does for SRAM caches. (These replacement algorithms are beyond our scope here.) Finally, because of the large access time of disk, DRAM caches always use write-back instead of write-through.



## 9.3.2 Page Tables

As with any cache, the VM system must have some way to determine if a virtual page is cached somewhere in DRAM. If so, the system must determine which physical page it is cached in. If there is a miss, the system must determine






**Figure 9.4** Page table.

where the virtual page is stored on disk, select a victim page in physical memory, and copy the virtual page from disk to DRAM, replacing the victim page.

These capabilities are provided by a combination of operating system software, address translation hardware in the MMU (memory

management unit), and a data structure stored in physical memory known as a *page table* that maps virtual pages to physical pages. The address translation hardware reads the page table each time it converts a virtual address to a physical address. The operating system is responsible for maintaining the contents of the page table and transferring pages back and forth between disk and DRAM.



**Figure 9.4**  shows the basic organization of a page table. A page table is an array of *page table entries (PTEs)*. Each page in the virtual address space has a PTE at a fixed offset in the page table. For our purposes, we will assume that each PTE consists of a *valid bit* and an *n-bit* address field. The valid bit indicates whether the virtual page is currently cached in DRAM. If the valid bit is set, the address field indicates the start of the corresponding physical page in DRAM where the virtual page is cached. If the valid bit is not set, then a null address indicates that the virtual page has not yet been allocated. Otherwise, the address points to the start of the virtual page on disk.

The example in **Figure 9.4**  shows a page table for a system with eight virtual pages and four physical pages. Four virtual pages (VP 1, VP 2, VP 4, and VP 7) are currently cached in DRAM. Two pages (VP 0 and VP 5) have not yet been allocated, and the rest (VP 3 and VP 6) have been allocated but are not currently cached. An important point to notice about **Figure 9.4**  is that because the DRAM cache is fully associative, any physical page can contain any virtual page.


## *Practice Problem 9.2 (solution page **881**)*

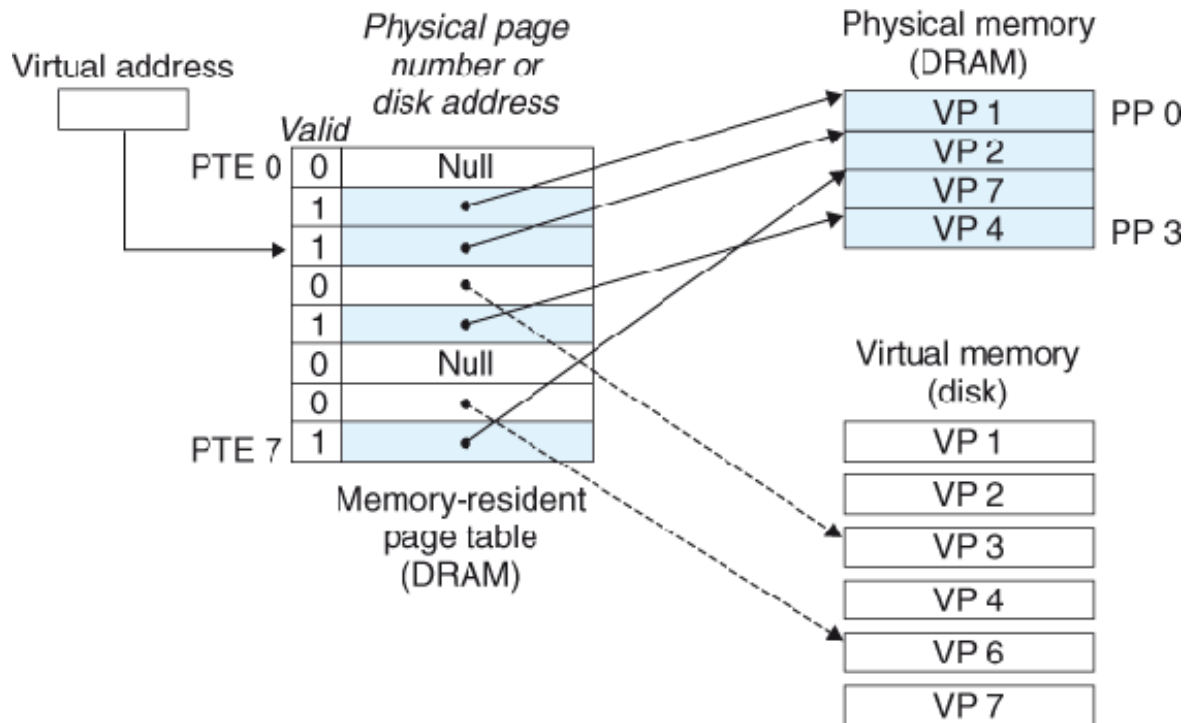
Determine the number of page table entries (PTEs) that are needed for the following combinations of virtual address size ( $n$ ) and page size ( $P$ ):

### 9.3.3 Page Hits

Consider what happens when the CPU reads a word of virtual memory contained in VP 2, which is cached in DRAM (**Figure 9.5** ). Using a technique we will describe in detail in **Section 9.6** , the address translation hardware uses the virtual address as an index to locate PTE 2 and read it from memory. Since the valid bit is set, the address translation hardware knows that VP 2 is cached in memory. So it uses the physical memory address in the PTE (which points to the start of the cached page in PP 1) to construct the physical address of the word.

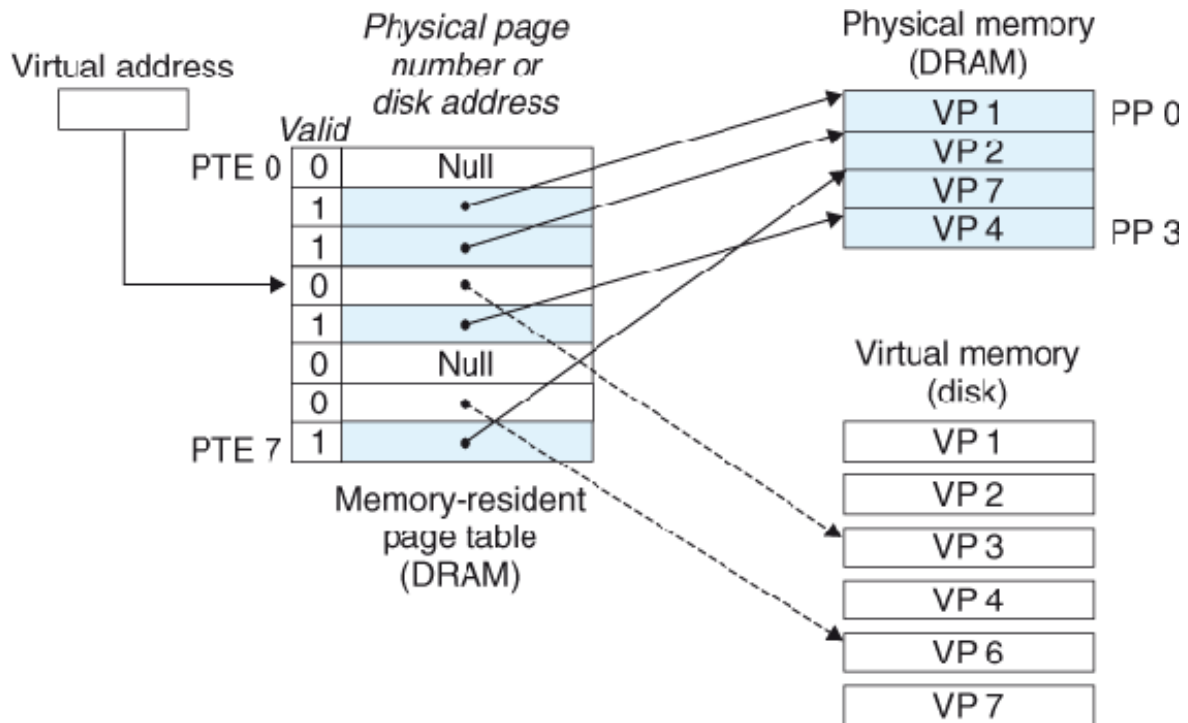
## 9.3.4 Page Faults

In virtual memory parlance, a DRAM cache miss is known as a *page fault*. **Figure 9.6**  shows the state of our example page table before the fault. The CPU has referenced a word in VP 3, which is not cached in DRAM. The address translation hardware reads PTE 3 from memory, infers from the valid bit that VP 3 is not cached, and triggers a page fault exception. The page fault exception invokes a page fault exception handler in the kernel, which selects a victim page—in this case, VP 4 stored in PP 3. If VP 4 has been modified, then the kernel copies it back to disk. In either case, the kernel modifies the page table entry for VP 4 to reflect the fact that VP 4 is no longer cached in main memory.



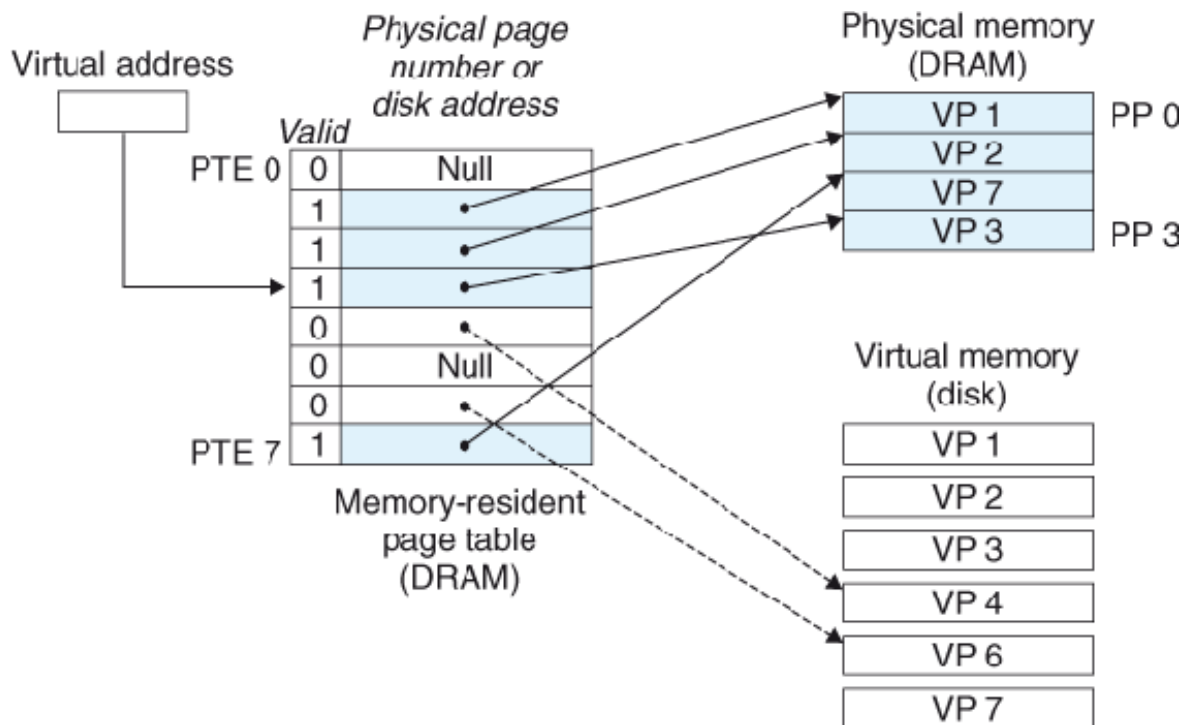
**Figure 9.5 VM page hit.**

The reference to a word in VP 2 is a hit.



**Figure 9.6 VM page fault (before).**

The reference to a word in VP 3 is a miss and triggers a page fault.



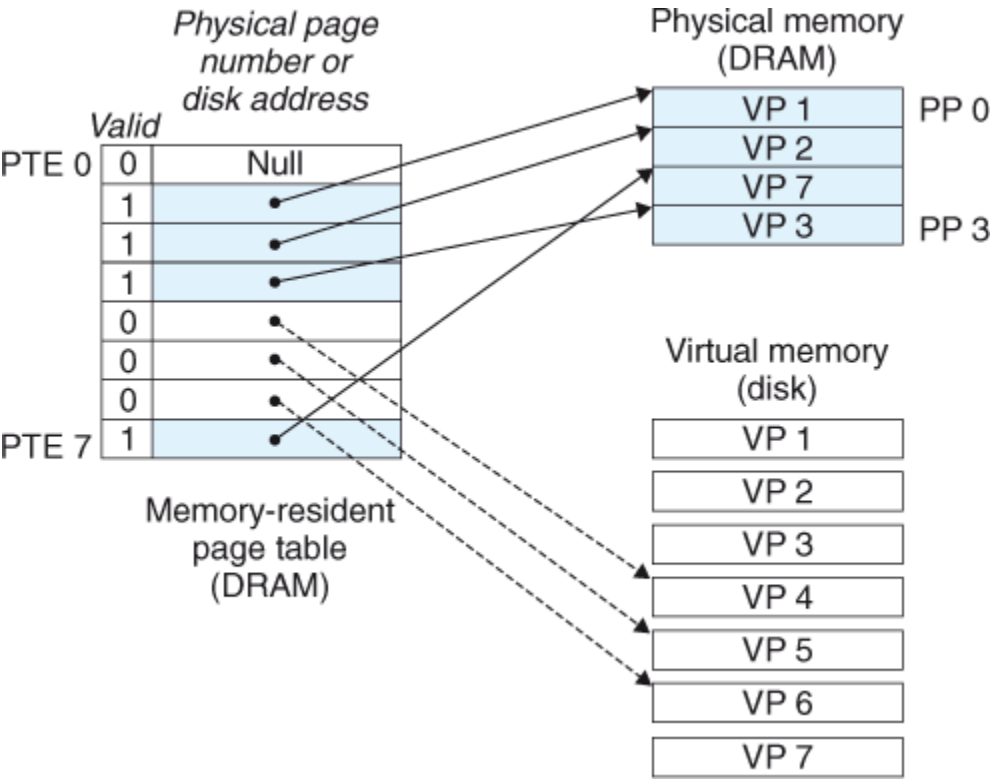
**Figure 9.7 VM page fault (after).**

The page fault handler selects VP 4 as the victim and replaces it with a copy of VP 3 from disk. After the page fault handler restarts the faulting instruction, it will read the word from memory normally, without generating an exception.

Next, the kernel copies VP 3 from disk to PP 3 in memory, updates PTE 3, and then returns. When the handler returns, it restarts the faulting instruction, which resends the faulting virtual address to the address translation hardware. But now, VP 3 is cached in main memory, and the page hit is handled normally by the address translation hardware. [Figure 9.7](#) shows the state of our example page table after the page fault.

Virtual memory was invented in the early 1960s, long before the widening CPU-memory gap spawned SRAM caches. As a result,

virtual memory systems use a different terminology from SRAM caches, even though many of the ideas are similar. In virtual memory parlance, blocks are known as pages. The activity of transferring a page between disk and memory is known as *swapping* or *paging*. Pages are *swapped in* (*paged in*) from disk to DRAM, and *swapped out* (*paged out*) from DRAM to disk. The strategy of waiting until the last moment to swap



**Figure 9.8 Allocating a new virtual page.**


The kernel allocates VP 5 on disk and points PTE 5 to this new location.

in a page, when a miss occurs, is known as *demand paging*. Other approaches, such as trying to predict misses and swap pages in



before they are actually referenced, are possible. However, all modern systems use demand paging.

## 9.3.5 Allocating Pages

**Figure 9.8**  shows the effect on our example page table when the operating system allocates a new page of virtual memory—for example, as a result of calling `malloc`. In the example, VP 5 is allocated by creating room on disk and updating PTE 5 to point to the newly created page on disk.

## 9.3.6 Locality to the Rescue Again

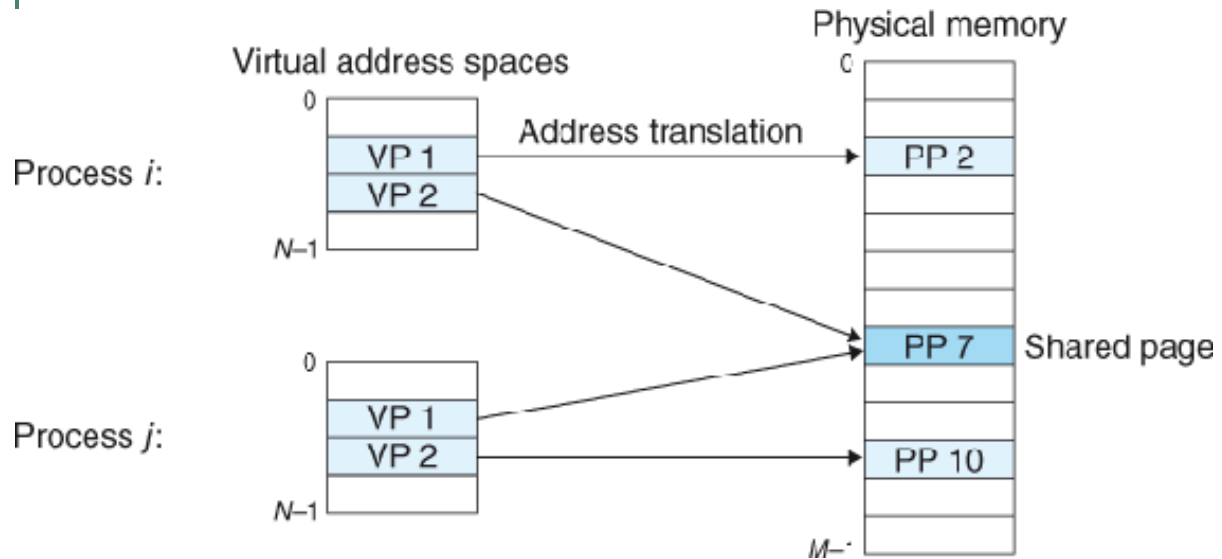
When many of us learn about the idea of virtual memory, our first impression is often that it must be terribly inefficient. Given the large miss penalties, we worry that paging will destroy program performance. In practice, virtual memory works well, mainly because of our old friend *locality*.

Although the total number of distinct pages that programs reference during an entire run might exceed the total size of physical memory, the principle of locality promises that at any point in time they will tend to work on a smaller set of *active pages* known as the *working set* or *resident set*. After an initial overhead where the working set is paged into memory, subsequent references to the working set result in hits, with no additional disk traffic.

As long as our programs have good temporal locality, virtual memory systems work quite well. But of course, not all programs exhibit good temporal locality. If the working set size exceeds the size of physical memory, then the program can produce an unfortunate situation known as *thrashing*, where pages are swapped in and out continuously. Although virtual memory is usually efficient, if a program's performance slows to a crawl, the wise programmer will consider the possibility that it is thrashing.

# Aside Counting page faults

You can monitor the number of page faults (and lots of other information) with the Linux `getrusage` function.




**Figure 9.9** How VM provides processes with separate address spaces.

The operating system maintains a separate page table for each process in the system.

## 9.4 VM as a Tool for Memory Management

In the last section, we saw how virtual memory provides a mechanism for using the DRAM to cache pages from a typically larger virtual address space. Interestingly, some early systems such as the DEC PDP-11/70 supported a virtual address space that was *smaller* than the available physical memory. Yet virtual memory was still a useful mechanism because it greatly simplified memory management and provided a natural way to protect memory.

Thus far, we have assumed a single page table that maps a single virtual address space to the physical address space. In fact, operating systems provide a separate page table, and thus a separate virtual address space, for each process. **Figure 9.9**  shows the basic idea. In the example, the page table for process *i* maps VP 1 to PP 2 and VP 2 to PP 7. Similarly, the page table for process *j* maps VP 1 to PP 7 and VP 2 to PP 10. Notice that multiple virtual pages can be mapped to the same shared physical page.

The combination of demand paging and separate virtual address spaces has a profound impact on the way that memory is used and managed in a system. In particular, VM simplifies linking and loading, the sharing of code and data, and allocating memory to applications.

- **Simplifying linking.** A separate address space allows each process to use the same basic format for its memory image, regardless of where the code and data actually reside in physical memory. For example, as we saw in [Figure 8.13](#), every process on a given Linux system has a similar memory format. For 64-bit address spaces, the code segment *always* starts at virtual address `0x400000`. The data segment follows the code segment after a suitable alignment gap. The stack occupies the highest portion of the user process address space and grows downward. Such uniformity greatly simplifies the design and implementation of linkers, allowing them to produce fully linked executables that are independent of the ultimate location of the code and data in physical memory.
- **Simplifying loading.** Virtual memory also makes it easy to load executable and shared object files into memory. To load the `.text` and `.data` sections of an object file into a newly created process, the Linux loader allocates virtual pages for the code and data segments, marks them as invalid (i.e., not cached), and points their page table entries to the appropriate locations in the object file. The interesting point is that the loader never actually copies any data from disk into memory. The data are paged in automatically and on demand by the virtual memory system the first time each page is referenced, either by the CPU when it fetches an instruction or by an executing instruction when it references a memory location.

This notion of mapping a set of contiguous virtual pages to an arbitrary location in an arbitrary file is known as *memory*

*mapping*. Linux provides a system call called `mmap` that allows application programs to do their own memory mapping. We will describe application-level memory mapping in more detail in [Section 9.8](#).

- **Simplifying sharing.** Separate address spaces provide the operating system with a consistent mechanism for managing sharing between user processes and the operating system itself. In general, each process has its own private code, data, heap, and stack areas that are not shared with any other process. In this case, the operating system creates page tables that map the corresponding virtual pages to disjoint physical pages.

However, in some instances it is desirable for processes to share code and data. For example, every process must call the same operating system kernel code, and every C program makes calls to routines in the standard C library such as `printf`. Rather than including separate copies of the kernel and standard C library in each process, the operating system can arrange for multiple processes to share a single copy of this code by mapping the appropriate virtual pages in different processes to the same physical pages, as we saw in [Figure 9.9](#).

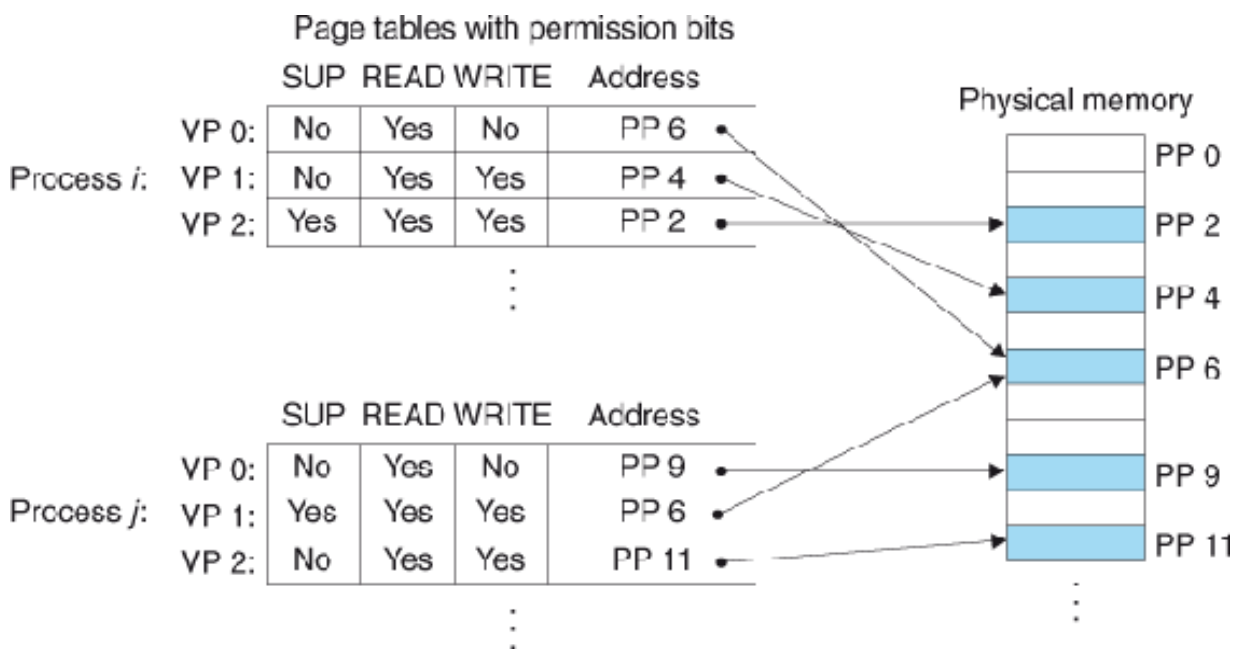
- **Simplifying memory allocation.** Virtual memory provides a simple mechanism for allocating additional memory to user processes. When a program running in a user process requests additional heap space (e.g., as a result of calling `malloc`), the operating system allocates an appropriate number, say,  $k$ , of contiguous virtual memory pages, and maps them to  $k$  arbitrary physical pages located anywhere in physical memory. Because

of the way page tables work, there is no need for the operating system to locate  $k$  contiguous pages of physical memory. The pages can be scattered randomly in physical memory.

[OceanofPDF.com](http://OceanofPDF.com)

# 9.5 VM as a Tool for Memory Protection

Any modern computer system must provide the means for the operating system to control access to the memory system. A user process should not be allowed




**Figure 9.10 Using VM to provide page-level memory protection.**

to modify its read-only code section. Nor should it be allowed to read or modify any of the code and data structures in the kernel. It should not be allowed to read or write the private memory of other processes, and it should not be allowed to modify any virtual pages that are shared with other processes, unless all parties explicitly



allow it (via calls to explicit interprocess communication system calls).

As we have seen, providing separate virtual address spaces makes it easy to isolate the private memories of different processes. But the address translation mechanism can be extended in a natural way to provide even finer access control. Since the address translation hardware reads a PTE each time the CPU generates an address, it is straightforward to control access to the contents of a virtual page by adding some additional permission bits to the PTE. **Figure 9.10**  shows the general idea.

In this example, we have added three permission bits to each PTE. The SUP bit indicates whether processes must be running in kernel (supervisor) mode to access the page. Processes running in kernel mode can access any page, but processes running in user mode are only allowed to access pages for which SUP is 0. The READ and WRITE bits control read and write access to the page. For example, if process  $i$  is running in user mode, then it has permission to read VP 0 and to read or write VP 1. However, it is not allowed to access VP 2.

If an instruction violates these permissions, then the CPU triggers a general protection fault that transfers control to an exception handler in the kernel, which sends a SIGSEGV signal to the offending process. Linux shells typically report this exception as a "segmentation fault."

[OceanofPDF.com](http://OceanofPDF.com)

## 9.6 Address Translation

This section covers the basics of address translation. Our aim is to give you an appreciation of the hardware's role in supporting virtual memory, with enough detail so that you can work through some concrete examples by hand. However, keep in mind that we are omitting a number of details, especially related to timing,

**Figure 9.11** Summary of address translation symbols.

that are important to hardware designers but are beyond our scope. For your reference, **Figure 9.11** summarizes the symbols that we will be using throughout this section.

Formally, address translation is a mapping between the elements of an  $N$ -element virtual address space (VAS) and an  $M$ -element physical address space (PAS),

$$\text{MAP} : \text{VAS} \rightarrow \text{PAS} \cup \phi$$

where

$$\text{MAP}(A) = \begin{cases} A' & \text{if data at virtual addr. } A \text{ are present at physical addr. } A' \text{ in PAS} \\ \phi & \text{if data at virtual addr. } A \text{ are not present in physical memory} \end{cases}$$

**Figure 9.12** shows how the MMU uses the page table to perform this mapping. A control register in the CPU, the *page table base register (PTBR)* points to the current page table. The  $n$ -bit virtual address has two components: a  $p$ -bit *virtual page offset (VPO)* and an  $(n - p)$ -bit *virtual page number (VPN)*. The MMU uses the VPN to select the appropriate PTE. For example, VPN 0 selects PTE 0, VPN 1 selects PTE 1, and so on. The corresponding physical address is the concatenation of the *physical page number (PPN)* from the page table entry and the VPO from the virtual address. Notice that since the physical and virtual pages are both  $P$  bytes, the *physical page offset (PPO)* is identical to the VPO.

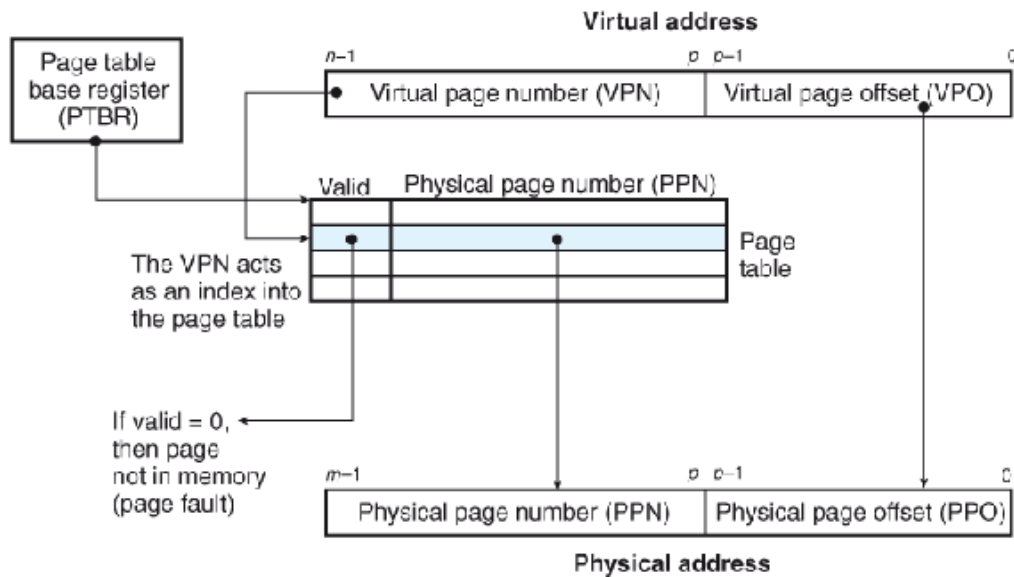




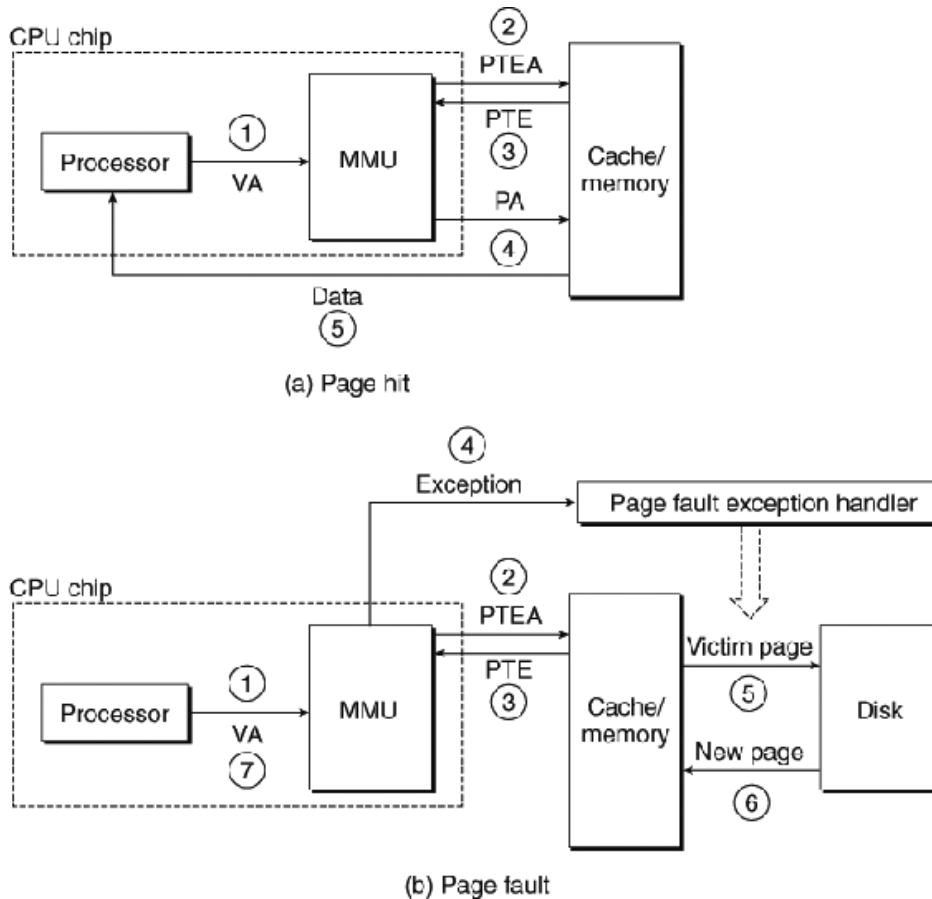
Figure 9.12 Address translation with a page table.

Figure 9.13(a)  shows the steps that the CPU hardware performs when there is a page hit.

- Step 1. The processor generates a virtual address and sends it to the MMU.
- Step 2. The MMU generates the PTE address and requests it from the cache/main memory.
- Step 3. The cache/main memory returns the PTE to the MMU.
- Step 4. The MMU constructs the physical address and sends it to the cache/main memory.
- Step 5. The cache/main memory returns the requested data word to the processor.

Unlike a page hit, which is handled entirely by hardware, handling a page fault requires cooperation between hardware and the operating system kernel (Figure 9.13(b) ).

- Steps 1 to 3. The same as steps 1 to 3 in Figure 9.13(a) .
- Step 4. The valid bit in the PTE is zero, so the MMU triggers an exception, which transfers control in the CPU to a page fault exception handler in the operating system kernel.
- Step 5. The fault handler identifies a victim page in physical memory, and if that page has been modified, pages it out to disk.
- Step 6. The fault handler pages in the new page and updates the PTE in memory.



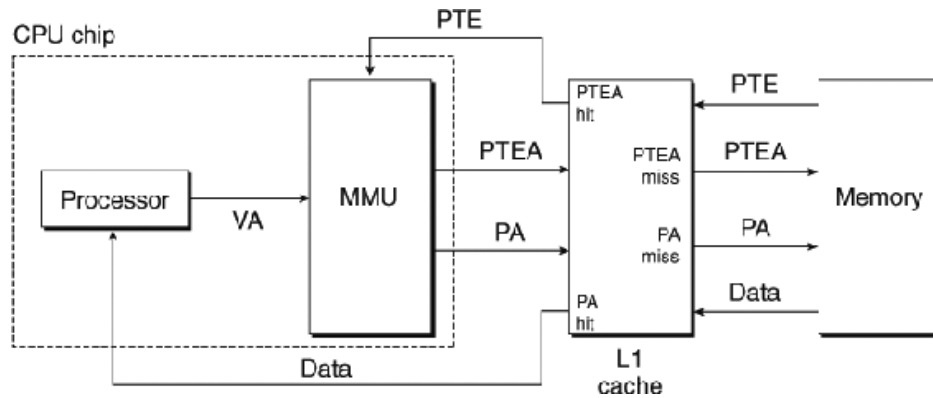
**Figure 9.13 Operational view of page hits and page faults.**

VA: virtual address. PTEA: page table entry address. PTE: page table entry. PA: physical address.

Step 7. The fault handler returns to the original process, causing the faulting instruction to be restarted. The CPU resends the offending virtual address to the MMU. Because the virtual page is now cached in physical memory, there is a hit, and after the MMU performs the steps in [Figure 9.13\(a\)](#), the main memory returns the requested word to the processor.

## Practice Problem 9.3 (solution page **881**)

Given a 32-bit virtual address space and a 24-bit physical address, determine the number of bits in the VPN, VPO, PPN, and PPO for the following page sizes  $P$ :



**Figure 9.14 Integrating VM with a physically addressed cache.**

VA: virtual address. PTEA: page table entry address. PTE: page table entry. PA: physical address.

## 9.6.1 Integrating Caches and VM

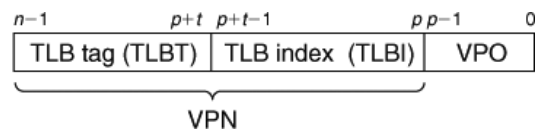
In any system that uses both virtual memory and SRAM caches, there is the issue of whether to use virtual or physical addresses to access the SRAM cache. Although a detailed discussion of the trade-offs is beyond our scope here, most systems opt for physical addressing. With physical addressing, it is straightforward for multiple processes to have blocks in the cache at the same time and to share blocks from the same virtual pages. Further, the cache does not have to deal with protection issues, because access rights are checked as part of the address translation process.

**Figure 9.14** shows how a physically addressed cache might be integrated with virtual memory. The main idea is that the address translation occurs before the cache lookup. Notice that page table entries can be cached, just like any other data words.

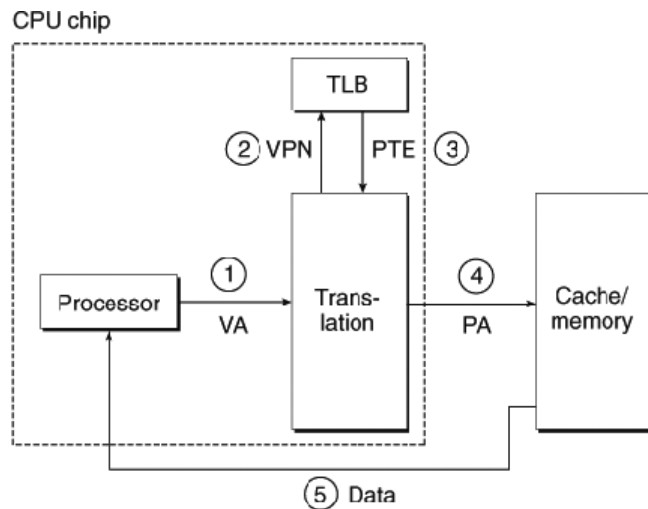
## 9.6.2 Speeding Up Address Translation with a TLB

As we have seen, every time the CPU generates a virtual address, the MMU must refer to a PTE in order to translate the virtual address into a physical address. In the worst case, this requires an additional fetch from memory, at a cost of tens to hundreds of cycles. If the PTE happens to be cached in L1, then the cost goes down to a handful of cycles. However, many systems try to eliminate even this cost by including a small cache of PTEs in the MMU called a *translation lookaside buffer (TLB)*.

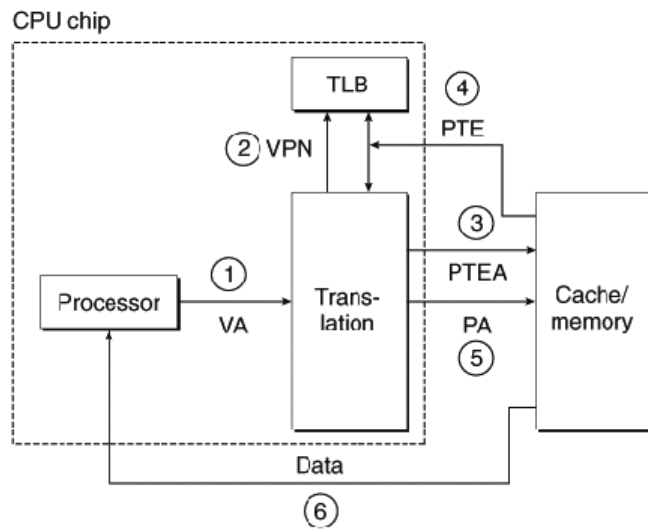
A TLB is a small, virtually addressed cache where each line holds a block consisting of a single PTE. A TLB usually has a high degree of associativity. As shown in [Figure 9.15](#), the index and tag fields that are used for set selection and line matching are extracted from the virtual page number in the virtual address. If the TLB has  $T = 2^t$  sets, then the *TLB index (TLBI)* consists of the  $t$  least significant bits of the VPN, and the *TLB tag (TLBT)* consists of the remaining bits in the VPN.



**Figure 9.15** Components of a virtual address that are used to access the TLB.



(a) TLB hit



(b) TLB miss

Figure 9.16 Operational view of a TLB hit and miss.

Figure 9.16(a) shows the steps involved when there is a TLB hit (the usual case). The key point here is that all of the address translation steps are performed inside the on-chip MMU and thus are fast.

Step 1. The CPU generates a virtual address.

Steps 2 and 3. The MMU fetches the appropriate PTE from the TLB.

Step 4. The MMU translates the virtual address to a physical address and sends it to the cache/main memory.

Step 5. The cache/main memory returns the requested data word to the CPU.



When there is a TLB miss, then the MMU must fetch the PTE from the L1 cache, as shown in [Figure 9.16\(b\)](#). The newly fetched PTE is stored in the TLB, possibly overwriting an existing entry.

## 9.6.3 Multi-Level Page Tables

Thus far, we have assumed that the system uses a single page table to do address translation. But if we had a 32-bit address space, 4 KB pages, and a 4-byte PTE, then we would need a 4 MB page table resident in memory at all times, even if the application referenced only a small chunk of the virtual address space. The problem is compounded for systems with 64-bit address spaces.

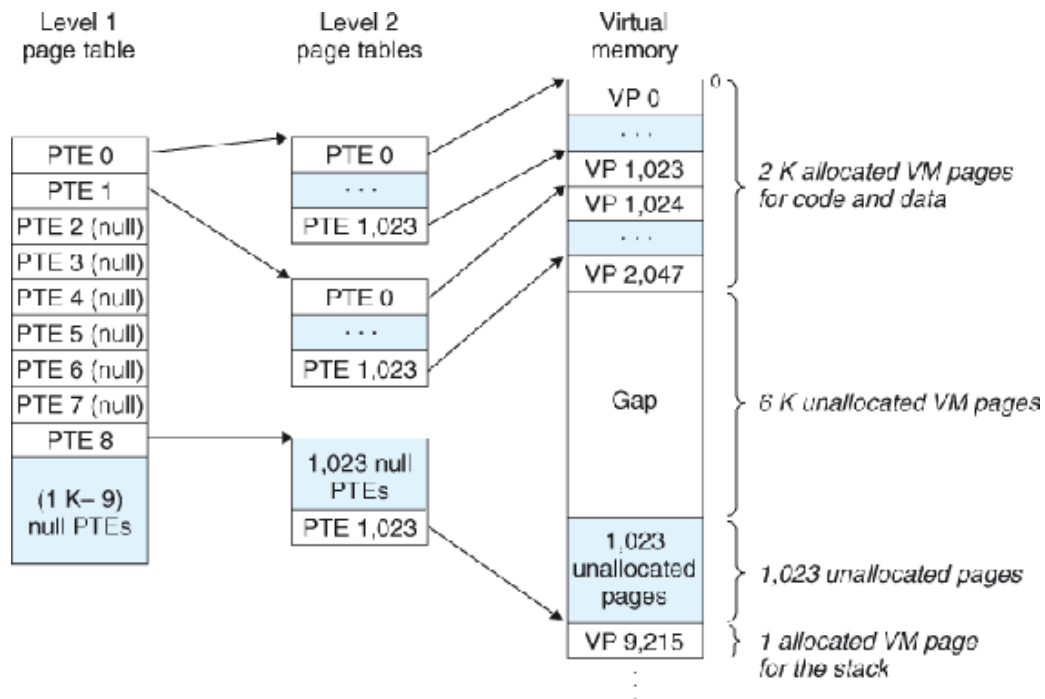
The common approach for compacting the page table is to use a hierarchy of page tables instead. The idea is easiest to understand with a concrete example. Consider a 32-bit virtual address space partitioned into 4 KB pages, with page table entries that are 4 bytes each. Suppose also that at this point in time the virtual address space has the following form: The first 2 K pages of memory are allocated for code and data, the next 6 K pages are unallocated, the next 1,023 pages are also unallocated, and the next page is allocated for the user stack. [Figure 9.17](#) shows how we might construct a two-level page table hierarchy for this virtual address space.

Each PTE in the level 1 table is responsible for mapping a 4 MB chunk of the virtual address space, where each chunk consists of 1,024 contiguous pages. For example, PTE 0 maps the first chunk, PTE 1 the next chunk, and so on. Given that the address space is 4 GB, 1,024 PTEs are sufficient to cover the entire space.

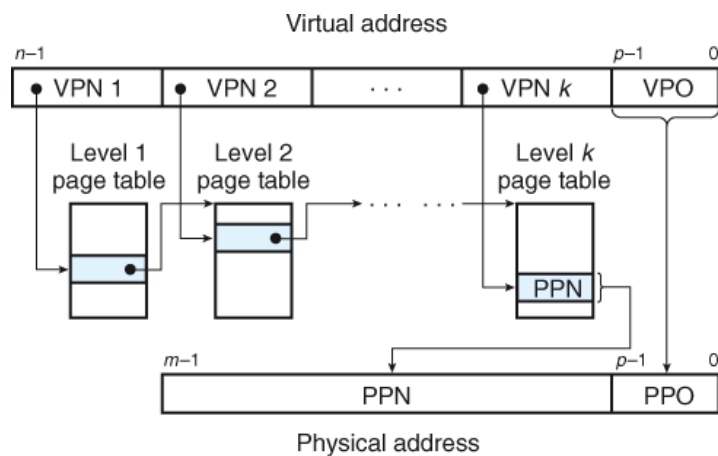
If every page in chunk  $i$  is unallocated, then level 1 PTE  $i$  is null. For example, in [Figure 9.17](#), chunks 2--7 are unallocated. However, if at least one page in chunk  $i$  is allocated, then level 1 PTE  $i$  points to the base of a level 2 page table. For example, in [Figure 9.17](#), all or portions of chunks 0,1, and 8 are allocated, so their level 1 PTEs point to level 2 page tables.

Each PTE in a level 2 page table is responsible for mapping a 4-KB page of virtual memory, just as before when we looked at single-level page tables. Notice that with 4-byte PTEs, each level 1 and level 2 page table is 4 kilobytes, which conveniently is the same size as a page.

This scheme reduces memory requirements in two ways. First, if a PTE in the level 1 table is null, then the corresponding level 2 page table does not even have to exist. This represents a significant potential savings, since most of the 4 GB virtual address space for a typical program is unallocated. Second, only the level 1 table needs to be in main memory at all times. The level 2 page tables can be created and paged in and out by the VM system as they are needed, which reduces pressure on main memory. Only the most heavily used level 2 page tables need to be cached in main memory.



**Figure 9.17** A two-level page table hierarchy. Notice that addresses increase from top to bottom.



**Figure 9.18** Address translation with a  $k$ -level page table.

**Figure 9.18** summarizes address translation with a  $k$ -level page table hierarchy. The virtual address is partitioned into  $k$  VPNs and a VPO. Each VPN  $i$ ,  $1 \leq i \leq k$ , is an index into a page table at level  $i$ . Each PTE in a level  $j$  table,  $1 \leq j \leq k - 1$ , points to the base of some page table at level  $j + 1$ . Each PTE in a level  $k$  table contains either the PPN of some physical page or the address of a disk block. To construct the physical address, the MMU must access  $k$  PTEs before it can determine the PPN. As with a single-level hierarchy, the PPO is identical to the VPO.

Accessing  $k$  PTEs may seem expensive and impractical at first glance. However, the TLB comes to the rescue here by caching PTEs from the page tables at the different levels. In practice, address translation with multi-level page tables is not significantly slower than with single-level page tables.

## 9.6.4 Putting It Together: End-to-End Address Translation

In this section, we put it all together with a concrete example of end-to-end address translation on a small system with a TLB and L1 d-cache. To keep things manageable, we make the following assumptions:

- The memory is byte addressable.
- Memory accesses are to *1-byte words* (not 4-byte words).
- Virtual addresses are 14 bits wide ( $n = 14$ ).
- Physical addresses are 12 bits wide ( $m = 12$ ).
- The page size is 64 bytes ( $P = 64$ ).
- The TLB is 4-way set associative with 16 total entries.
- The L1 d-cache is physically addressed and direct mapped, with a 4-byte line size and 16 total sets.

Figure 9.19 shows the formats of the virtual and physical addresses. Since each page is  $2^6 = 64$  bytes, the low-order 6 bits of the virtual and physical addresses serve as the VPO and PPO, respectively. The high-order 8 bits of the virtual address serve as the VPN. The high-order 6 bits of the physical address serve as the PPN.

Figure 9.20 shows a snapshot of our little memory system, including the TLB (Figure 9.20(a)), a portion of the page table (Figure 9.20(b)), and the L1 cache (Figure 9.20(c)). Above the figures of the TLB and cache, we have also shown how the bits of the virtual and physical addresses are partitioned by the hardware as it accesses these devices.

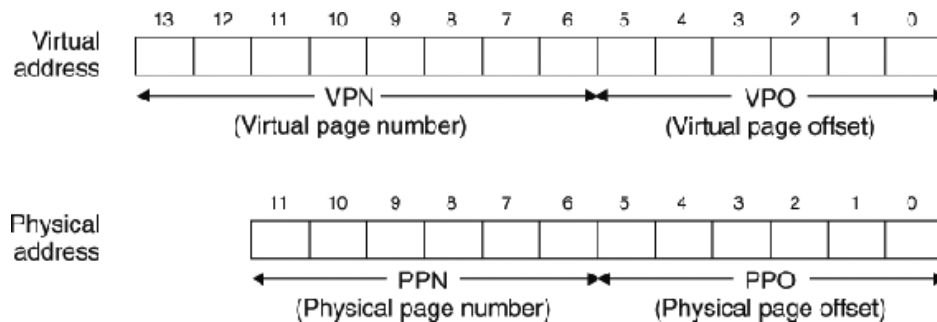
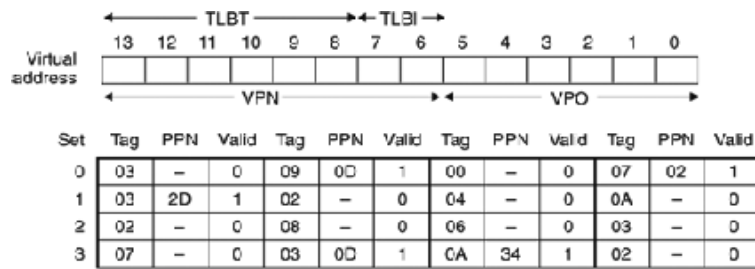


Figure 9.19 Addressing for small memory system.

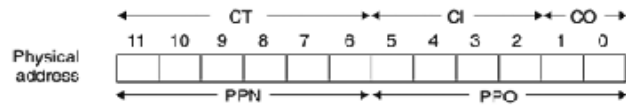
Assume 14-bit virtual addresses ( $n = 14$ ), 12-bit physical addresses ( $m = 12$ ), and 64-byte pages ( $P = 64$ ).



(a) TLB: 4 sets, 16 entres, 4-way set associative

VPN	PPN	Valid	VPN	PPN	Valid
00	28	1	08	13	1
01	-	0	09	17	1
02	33	1	0A	09	1
03	02	1	0B	-	0
04	-	0	0C	-	0
05	16	1	0D	2D	1
06	-	0	0E	11	1
07	-	0	0F	0D	1

(b) Page table: Only the first 16 PTEs are shown



Idx	Tag	Valid	Blk 0	Blk 1	Blk 2	Blk 3
0	19	1	99	11	23	11
1	15	0	-	-	-	-
2	1B	1	00	02	04	08
3	36	0	-	-	-	-
4	32	1	43	6D	3F	09
5	0D	1	36	72	F0	1D
6	31	0	-	-	-	-
7	16	1	11	C2	DF	03
8	24	1	3A	00	51	E9
9	2D	0	-	-	-	-
A	2D	1	93	15	DA	3B
B	0B	0	-	-	-	-
C	12	0	-	-	-	-
D	16	1	04	96	34	15
E	13	1	83	77	1B	D3
F	14	0	-	-	-	-

(c) Cache: 16 sets, 4-byte blocks, direct mapped

**Figure 9.20 TLB, page table, and cache for small memory system.**

All values in the TLB, page table, and cache are in hexadecimal notation.

**TLB.** The TLB is virtually addressed using the bits of the VPN. Since the TLB has four sets, the 2 low-order bits of the VPN serve as the set index (TLBI). The remaining 6 high-order bits serve as the tag (TLBT) that distinguishes the different VPNs that might map to the same TLB set.

**Page table.** The page table is a single-level design with a total of  $2^8 = 256$  page table entries (PTEs). However, we are only interested in the first 16 of these. For convenience,

we have labeled each PTE with the VPN that indexes it; but keep in mind that these VPNs are not part of the page table and not stored in memory. Also, notice that the PPN of each invalid PTE is denoted with a dash to reinforce the idea that whatever bit values might happen to be stored there are not meaningful.

**Cache.** The direct-mapped cache is addressed by the fields in the physical address. Since each block is 4 bytes, the low-order 2 bits of the physical address serve as the block offset (CO). Since there are 16 sets, the next 4 bits serve as the set index (CI). The remaining 6 bits serve as the tag (CT).

Given this initial setup, let's see what happens when the CPU executes a load instruction that reads the byte at address `0x03d4`. (Recall that our hypothetical CPU reads 1-byte words rather than 4-byte words.) To begin this kind of manual simulation, we find it helpful to write down the bits in the virtual address, identify the various fields we will need, and determine their hex values. The hardware performs a similar task when it decodes the address.

	TLBT						TLBI							
	0xC3						0x03							
Bit position	13	12	11	10	9	8	7	6	5	4	3	2	1	0
VA = 0x03d4	0	0	0	0	1	1	1	1	0	1	0	1	0	0
	VPN						VPO							
	0x0f						0x14							

To begin, the MMU extracts the VPN (`0x0F`) from the virtual address and checks with the TLB to see if it has cached a copy of PTE `0x0F` from some previous memory reference. The TLB extracts the TLB index (`0x03`) and the TLB tag (`0x3`) from the VPN, hits on a valid match in the second entry of set `0x3`, and returns the cached PPN (`0x0D`) to the MMU.

If the TLB had missed, then the MMU would need to fetch the PTE from main memory. However, in this case, we got lucky and had a TLB hit. The MMU now has everything it needs to form the physical address. It does this by concatenating the PPN (`0x0D`) from the PTE with the VPO (`0x14`) from the virtual address, which forms the physical address (`0x354`).

Next, the MMU sends the physical address to the cache, which extracts the cache offset CO (`0x0`), the cache set index CI (`0x5`), and the cache tag CT (`0x0D`) from the physical address.

	CT						CI				CO	
	0x0d						0x05				0x0	
Bit position	11	10	9	8	7	6	5	4	3	2	1	0
PA = 0x354	0	0	1	1	0	1	0	1	0	1	0	0
	PPN						PPO					
	0x0d						0x14					

Since the tag in set `0x5` matches CT, the cache detects a hit, reads out the data byte (`0x36`) at offset CO, and returns it to the MMU, which then passes it back to the CPU.

Other paths through the translation process are also possible. For example, if the TLB misses, then the MMU must fetch the PPN from a PTE in the page table. If the resulting PTE is invalid, then there is a page fault and the kernel must page in the appropriate page and rerun the load instruction. Another possibility is that the PTE is valid, but the necessary memory block misses in the cache.

### Practice Problem 9.4 (solution page [881](#))

Show how the example memory system in [Section 9.6.4](#) translates a virtual address into a physical address and accesses the cache. For the given virtual address, indicate the TLB entry accessed, physical address, and cache byte value returned. Indicate whether the TLB misses, whether a page fault occurs, and whether a cache miss occurs. If there is a cache miss, enter "—" for "Cache byte returned." If there is a page fault, enter "—" for "PPN" and leave parts C and D blank.

Virtual address: `0x03d7`

A. Virtual address format

13	12	11	10	9	8	7	6	5	4	3	2	1	0

B. Address translation

C. Physical address format


11	10	9	8	7	6	5	4	3	2	1	0

D. Physical memory reference



## 9.7 Case Study: The Intel Core i7/Linux Memory System

We conclude our discussion of virtual memory mechanisms with a case study of a real system: an Intel Core i7 running Linux. Although the underlying Haswell microarchitecture allows for full 64-bit virtual and physical address spaces, the current Core i7 implementations (and those for the foreseeable future) support a 48-bit (256 TB) virtual address space and a 52-bit (4 PB) physical address space, along with a compatibility mode that supports 32-bit (4 GB) virtual and physical address spaces.

**Figure 9.21**  gives the highlights of the Core i7 memory system. The *processor package* (chip) includes four cores, a large L3 cache shared by all of the cores, and

Processor package

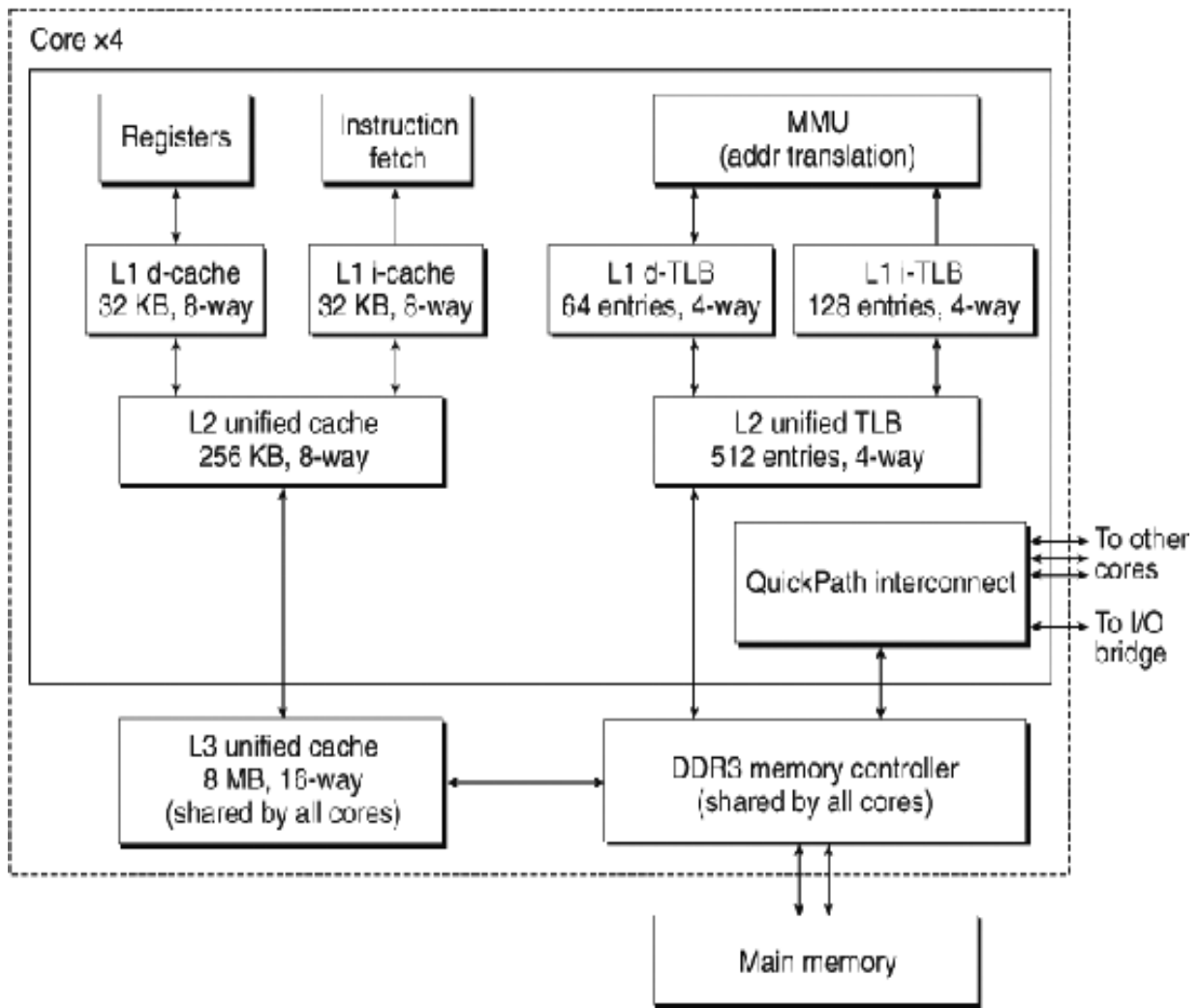
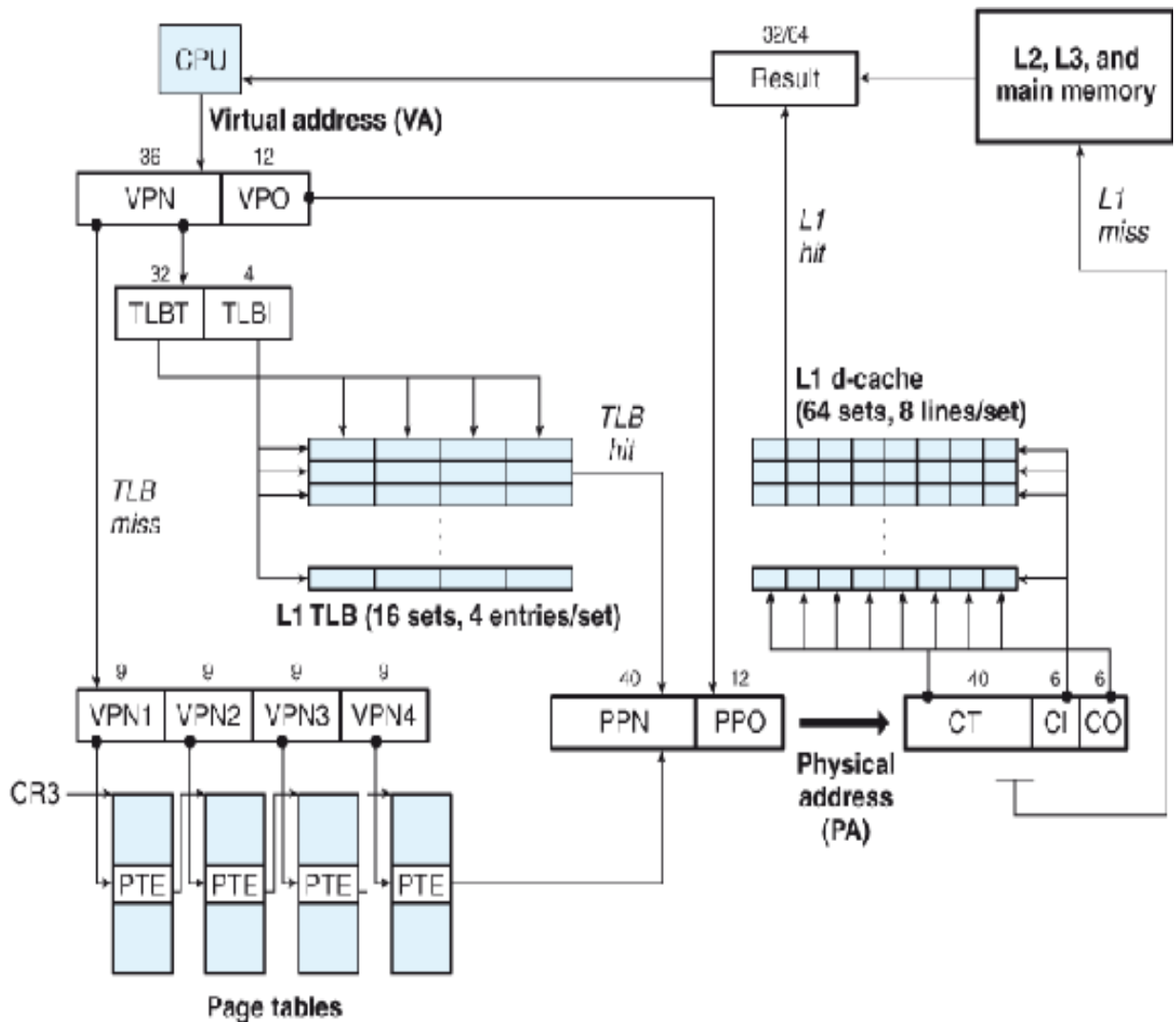


Figure 9.21 The Core i7 memory system.




**Figure 9.22 Summary of Core i7 address translation.**

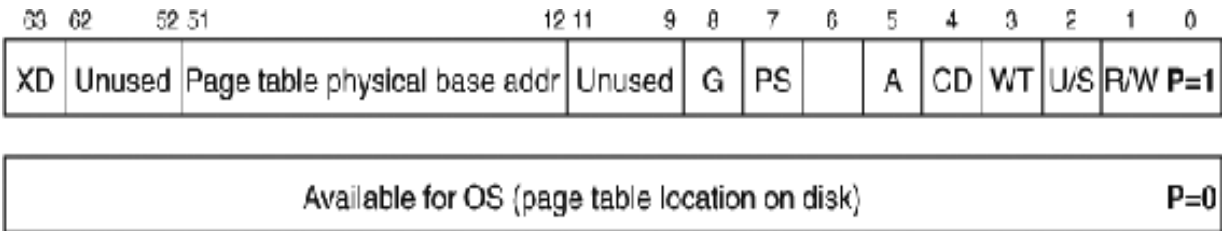
For simplicity, the i-caches, i-TLB, and L2 unified TLB are not shown.

a DDR3 memory controller. Each core contains a hierarchy of TLBs, a hierarchy of data and instruction caches, and a set of fast point-to-point links, based on the QuickPath technology, for communicating directly with the other cores and the external I/O bridge. The TLBs are virtually addressed, and 4-way set associative. The L1, L2, and L3 caches are physically addressed, with a block size of 64 bytes. L1 and L2 are 8-way set associative, and L3 is 16-way set associative.

The page size can be configured at start-up time as either 4 KB or 4 MB. Linux uses 4 KB pages.

## 9.7.1 Core i7 Address Translation

**Figure 9.22**  summarizes the entire Core i7 address translation process, from the time the CPU generates a virtual address until a data word arrives from memory. The Core i7 uses a four-level page table hierarchy. Each process has its own private page table hierarchy. When a Linux process is running, the page tables associated with allocated pages are all memory-resident, although the Core i7 architecture allows these page tables to be swapped in and out. The *CR3* control register contains the physical address of the beginning of the level 1 (L1) page table. The value of *CR3* is part of each process context, and is restored during each context switch.



**Figure 9.23** Format of level 1, level 2, and level 3 page table entries.

Each entry references a 4 KB child page table.

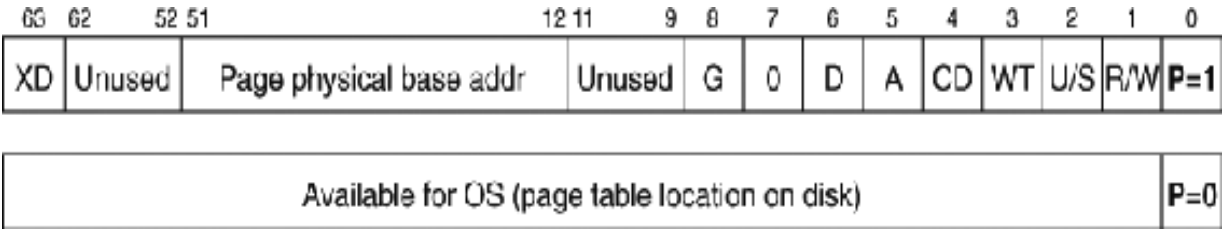
**Figure 9.23** shows the format of an entry in a level 1, level 2, or level 3 page table. When  $P = 1$  (which is always the case with Linux), the address field contains a 40-bit physical page number (PPN) that points to the beginning of the appropriate page table. Notice that this imposes a 4 KB alignment requirement on page tables.

**Figure 9.24** shows the format of an entry in a level 4 page table. When  $P = 1$ , the address field contains a 40-bit PPN that points to the base of some page in physical memory. Again, this imposes a 4 KB alignment requirement on physical pages.

The PTE has three permission bits that control access to the page. The *R/W* bit determines whether the contents of a page are read/write or read-only. The *U/S* bit, which determines whether the page can be accessed in user mode, protects code and data in the operating system kernel from user programs. The *XD* (execute disable) bit, which was introduced in 64-bit systems, can be used to disable instruction fetches from individual memory pages. This is an important new feature that allows the operating system kernel to

reduce the risk of buffer overflow attacks by restricting execution to the read-only code segment.


As the MMU translates each virtual address, it also updates two other bits that can be used by the kernel's page fault handler. The MMU sets the *A* bit, which is known as a *reference bit*, each time a page is accessed. The kernel can use the reference bit to implement its page replacement algorithm. The MMU sets the *D* bit, or *dirty bit*, each time the page is written to. A page that has been modified is sometimes called a *dirty page*. The dirty bit tells the kernel whether or not it must



**Figure 9.24** Format of level 4 page table entries.

Each entry references a 4 KB child page.


write back a victim page before it copies in a replacement page. The kernel can call a special kernel-mode instruction to clear the reference or dirty bits.

**Figure 9.25**  shows how the Core i7 MMU uses the four levels of page tables to translate a virtual address to a physical address. The 36-bit VPN is partitioned into four 9-bit chunks, each of which is used as an offset into a page table. The CR3 register contains the physical address of the L1 page table. VPN 1 provides an offset to an L1 PTE, which contains the base address of the L2 page table. VPN 2 provides an offset to an L2 PTE, and so on.

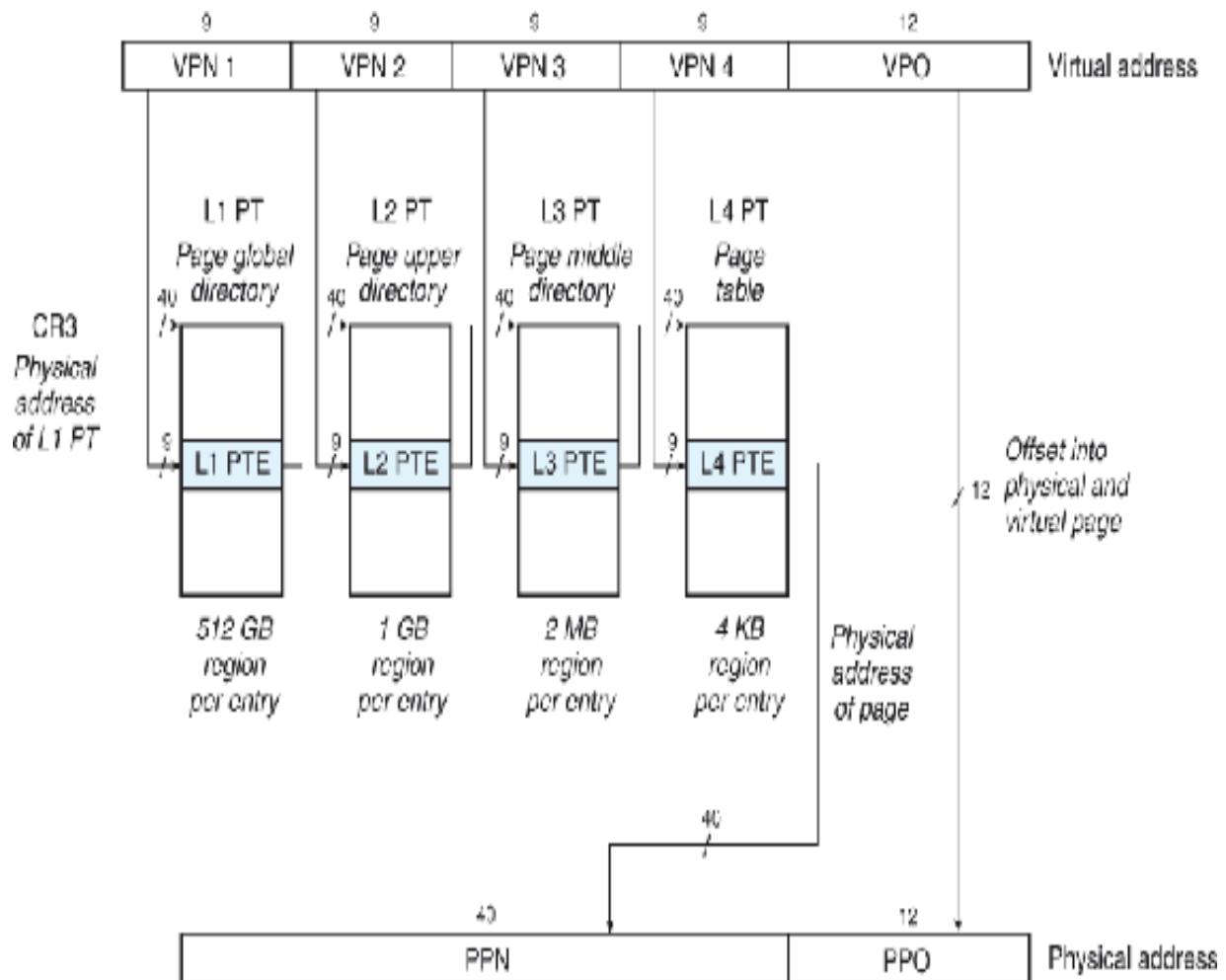


## 9.7.2 Linux Virtual Memory System

A virtual memory system requires close cooperation between the hardware and the kernel. Details vary from version to version, and a complete description is beyond our scope. Nonetheless, our aim in this section is to describe enough of the Linux virtual memory system to give you a sense of how a real operating system organizes virtual memory and how it handles page faults.

Linux maintains a separate virtual address space for each process of the form shown in [Figure 9.26](#) . We have seen this picture a number of times already, with its familiar code, data, heap, shared library, and stack segments. Now that we understand address translation, we can fill in some more details about the kernel virtual memory that lies above the user stack.

The kernel virtual memory contains the code and data structures in the kernel. Some regions of the kernel virtual memory are mapped to physical pages that



**Figure 9.25 Core i7 page table translation.**

PT: page table; PTE: page table entry; VPN: virtual page number; VPO: virtual page offset; PPN: physical page number; PPO: physical page offset. The Linux names for the four levels of page tables are also shown.

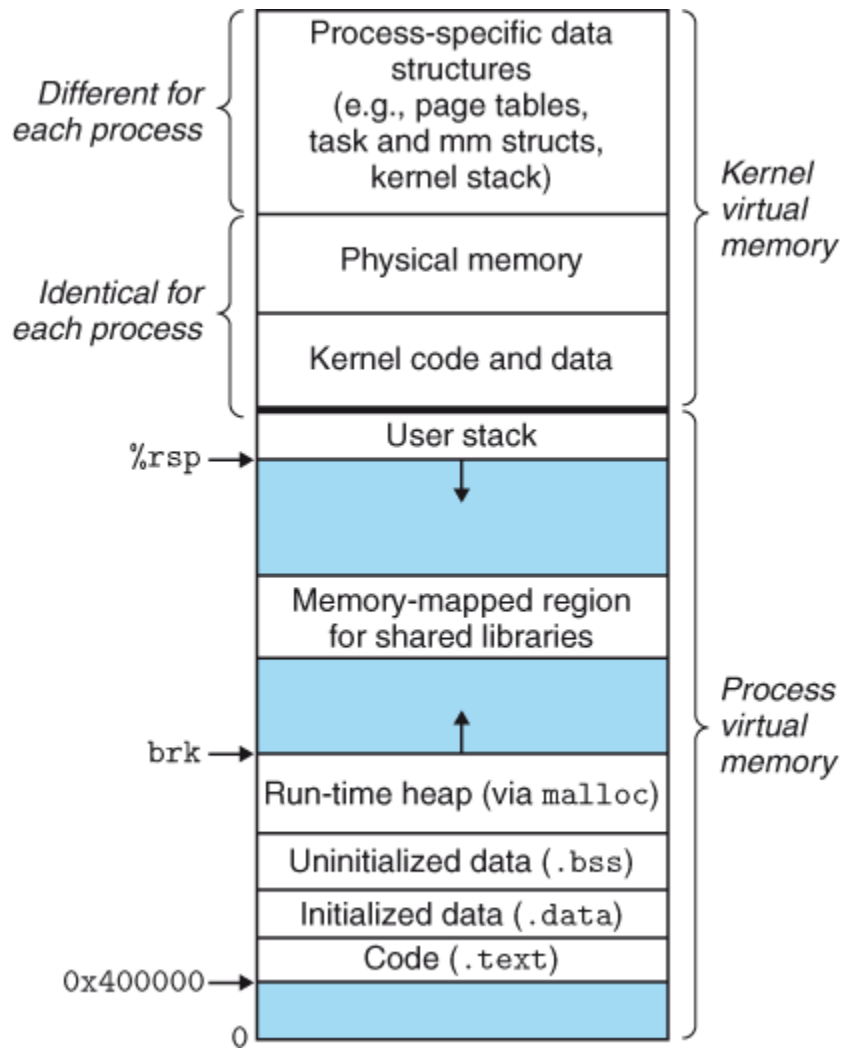


Figure 9.26 The virtual memory of a Linux process.

## Aside Optimizing address translation

In our discussion of address translation, we have described a sequential two-step process where the MMU (1) translates the virtual address to a physical address and then (2) passes the physical address to the L1 cache. However, real hardware implementations use a neat trick that allows these steps to be partially overlapped, thus speeding up accesses to the L1 cache. For example, a virtual address on a Core i7 with 4 KB pages has 12 bits of VPO, and these bits are identical to the 12 bits of PPO in the corresponding physical address. Since the 8-way set associative physically addressed L1 caches have 64 sets and 64-byte cache blocks, each physical address has 6 ( $\log_2 64$ ) cache offset bits and 6 ( $\log_2 64$ ) index bits. These 12 bits fit exactly in the 12-bit VPO of a virtual address, which is no accident! When the CPU needs a virtual address translated, it sends the VPN to the MMU and the VPO to the L1 cache. While the MMU is requesting a page table entry from the TLB, the L1 cache is busy using the VPO bits to find the appropriate set and read out the eight tags and corresponding data words in that set. When the MMU gets the PPN back from the TLB, the cache is ready to try to match the PPN to one of these eight tags.


are shared by all processes. For example, each process shares the kernel's code and global data structures. Interestingly, Linux also maps a set of contiguous virtual pages (equal in size to the total amount of DRAM in the system) to the corresponding set of contiguous physical pages. This provides the kernel with a

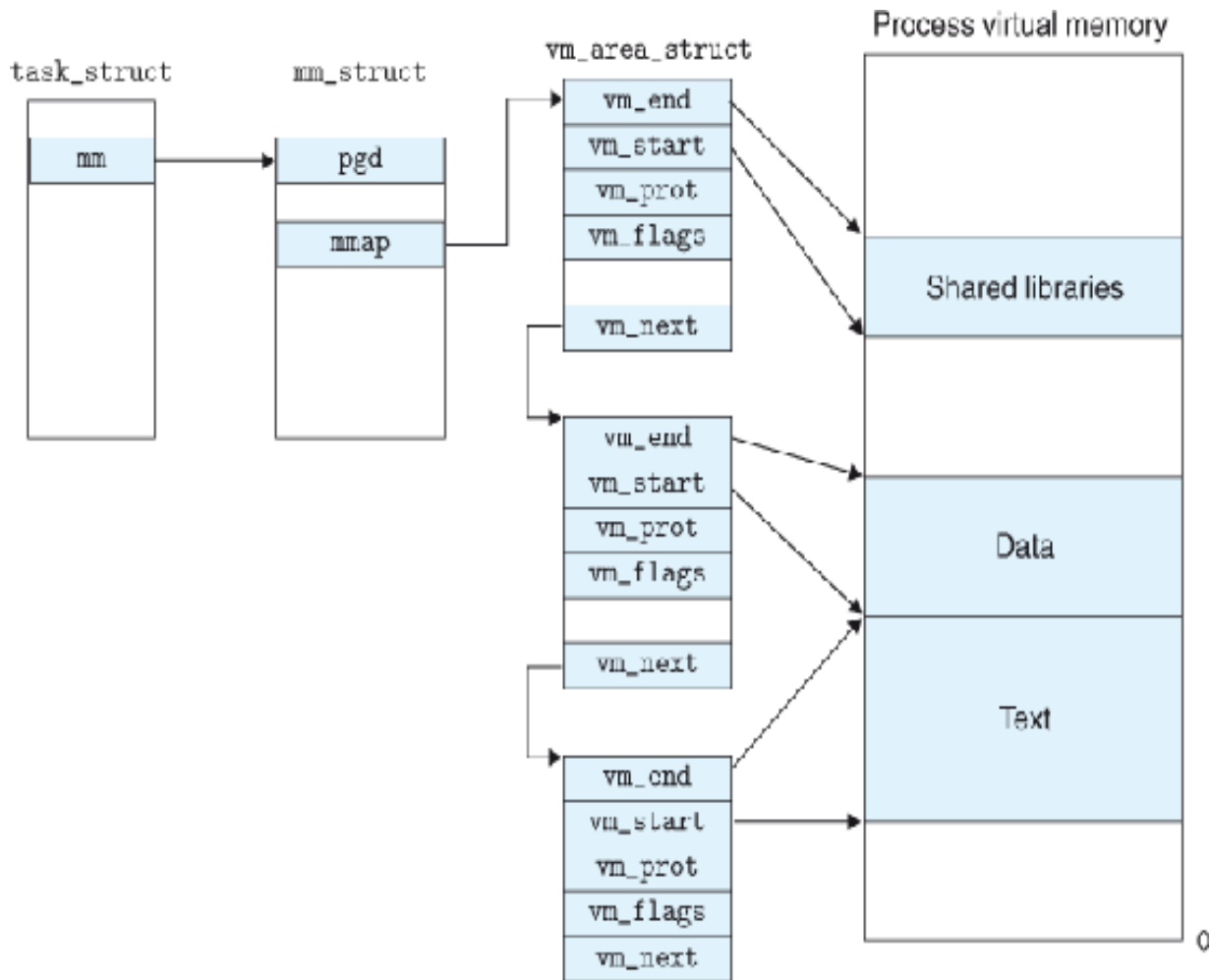
convenient way to access any specific location in physical memory—for example, when it needs to access page tables or to perform memory-mapped I/O operations on devices that are mapped to particular physical memory locations.

Other regions of kernel virtual memory contain data that differ for each process. Examples include page tables, the stack that the kernel uses when it is executing code in the context of the process, and various data structures that keep track of the current organization of the virtual address space.

## *Linux Virtual Memory Areas*

Linux organizes the virtual memory as a collection of *areas* (also called *segments*). An area is a contiguous chunk of existing (allocated) virtual memory whose pages are related in some way. For example, the code segment, data segment, heap, shared library segment, and user stack are all distinct areas. Each existing virtual page is contained in some area, and any virtual page that is not part of some area does not exist and cannot be referenced by the process. The notion of an area is important because it allows the virtual address space to have gaps. The kernel does not keep track of virtual pages that do not exist, and such pages do not consume any additional resources in memory, on disk, or in the kernel itself.

**Figure 9.27**  highlights the kernel data structures that keep track of the virtual memory areas in a process. The kernel maintains a distinct task structure (`task_struct` in the source code) for each process in the system. The elements of the task structure either contain or point to all of the information that the kernel needs to



**Figure 9.27** How Linux organizes virtual memory.

run the process (e.g., the PID, pointer to the user stack, name of the executable object file, and program counter).

One of the entries in the task structure points to an `mm_struct` that characterizes the current state of the virtual memory. The two fields of interest to us are `pgd`, which points to the base of the level 1 table (the page global directory), and `mmap`, which points to a list of `vm_area_structs` (area structs), each of which characterizes an area

of the current virtual address space. When the kernel runs this process, it stores `pgd` in the CR3 control register.

For our purposes, the area struct for a particular area contains the following fields:

`fv_start`. Points to the beginning of the area.

`vm_end`. Points to the end of the area.

`vm_prot`. Describes the read/write permissions for all of the pages contained in the area.

`vm_flags`. Describes (among other things) whether the pages in the area are shared with other processes or private to this process.

`vm_next`. Points to the next area struct in the list.



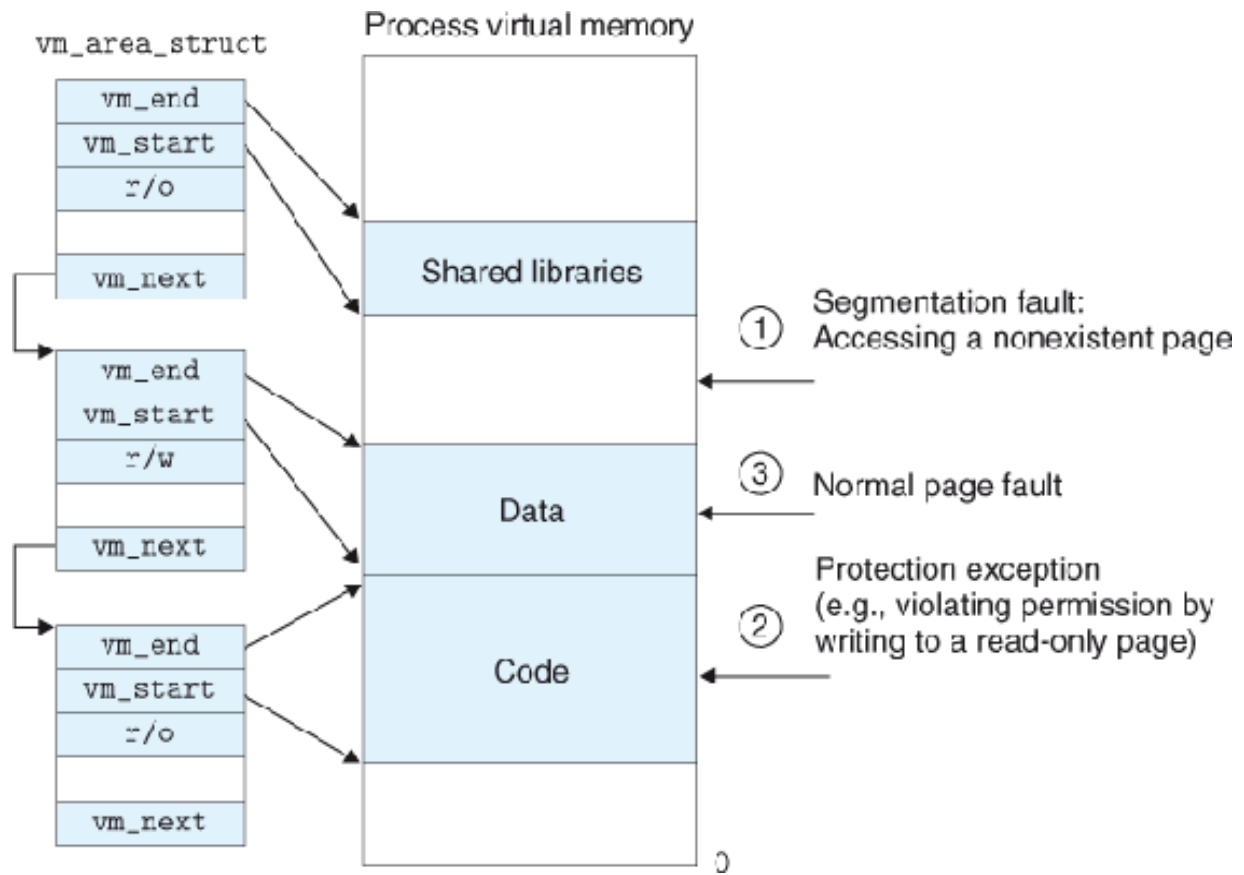



Figure 9.28 Linux page fault handling.


# *Linux Page Fault Exception Handling*

Suppose the MMU triggers a page fault while trying to translate some virtual address *A*. The exception results in a transfer of control to the kernel's page fault handler, which then performs the following steps:

1. Is virtual address *A* legal? In other words, does *A* lie within an area defined by some area struct? To answer this question, the fault handler searches the list of area structs, comparing *A* with the `vm_start` and `vm_end` in each area struct. If the instruction is not legal, then the fault handler triggers a segmentation fault, which terminates the process. This situation is labeled "1" in [Figure 9.28](#) .

Because a process can create an arbitrary number of new virtual memory areas (using the `mmap` function described in the next section), a sequential search of the list of area structs might be very costly. So in practice, Linux superimposes a tree on the list, using some fields that we have not shown, and performs the search on this tree.

2. Is the attempted memory access legal? In other words, does the process have permission to read, write, or execute the pages in this area? For example, was the page fault the result of a store instruction trying to write to a read-only page in the code segment? Is the page fault the result of a process running in user mode that is attempting to read a word from kernel virtual memory? If the attempted access is not legal, then the fault handler triggers a protection exception, which

terminates the process. This situation is labeled "2" in **Figure 9.28** .

3. At this point, the kernel knows that the page fault resulted from a legal operation on a legal virtual address. It handles the fault by selecting a victim page, swapping out the victim page if it is dirty, swapping in the new page, and updating the page table. When the page fault handler returns, the CPU restarts the faulting instruction, which sends *A* to the MMU again. This time, the MMU translates *A* normally, without generating a page fault.

[OceanofPDF.com](http://OceanofPDF.com)

## 9.8 Memory Mapping

Linux initializes the contents of a virtual memory area by associating it with an *object* on disk, a process known as *memory mapping*.

Areas can be mapped to one of two types of objects:

1. **Regular file in the Linux file system:** An area can be mapped to a contiguous section of a regular disk file, such as an executable object file. The file section is divided into page-size pieces, with each piece containing the initial contents of a virtual page. Because of demand paging, none of these virtual pages is actually swapped into physical memory until the CPU first *touches* the page (i.e., issues a virtual address that falls within that page's region of the address space). If the area is larger than the file section, then the area is padded with zeros.
2. **Anonymous file:** An area can also be mapped to an anonymous file, created by the kernel, that contains all binary zeros. The first time the CPU touches a virtual page in such an area, the kernel finds an appropriate victim page in physical memory, swaps out the victim page if it is dirty, overwrites the victim page with binary zeros, and updates the page table to mark the page as resident. Notice that no data are actually transferred between disk and memory. For this reason, pages in areas that are mapped to anonymous files are sometimes called *demand-zero pages*.

In either case, once a virtual page is initialized, it is swapped back and forth between a special *swap file* maintained by the kernel. The swap file is also known as the *swap space* or the *swap area*. An important point to realize is that at any point in time, the swap space bounds the total amount of virtual pages that can be allocated by the currently running processes.


## 9.8.1 Shared Objects Revisited

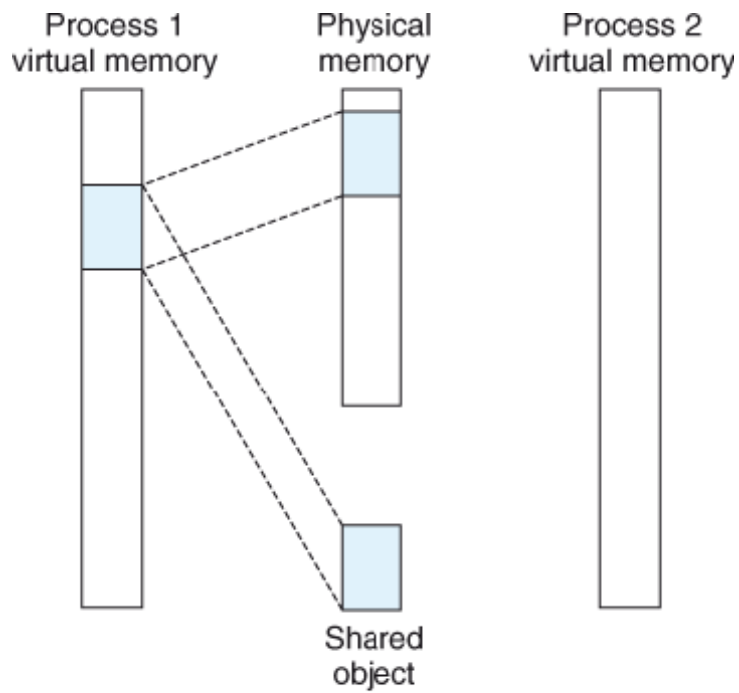
The idea of memory mapping resulted from a clever insight that if the virtual memory system could be integrated into the conventional file system, then it could provide a simple and efficient way to load programs and data into memory.

As we have seen, the process abstraction promises to provide each process with its own private virtual address space that is protected from errant writes or reads by other processes. However, many processes have identical read-only code areas. For example, each process that runs the Linux shell program `bash` has the same code area. Further, many programs need to access identical copies of read-only run-time library code. For example, every C program requires functions from the standard C library such as `printf`. It would be extremely wasteful for each process to keep duplicate copies of these commonly used codes in physical memory. Fortunately, memory mapping provides us with a clean mechanism for controlling how objects are shared by multiple processes.

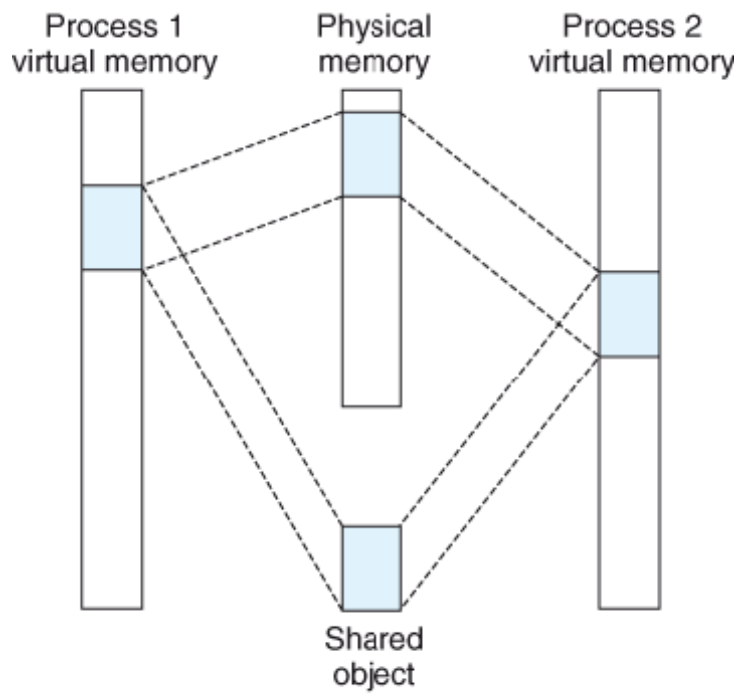
An object can be mapped into an area of virtual memory as either a *shared object* or a *private object*. If a process maps a shared object into an area of its virtual address space, then any writes that the process makes to that area are visible to any other processes that have also mapped the shared object into their virtual memory. Further, the changes are also reflected in the original object on disk.

Changes made to an area mapped to a private object, on the other hand, are not visible to other processes, and any writes that the process makes to the area are *not* reflected back to the object on disk. A virtual memory area into which a shared object is mapped is often called a *shared area*. Similarly for a *private area*.

Suppose that process 1 maps a shared object into an area of its virtual memory, as shown in [Figure 9.29\(a\)](#) . Now suppose that process 2 maps the same shared object



(a)

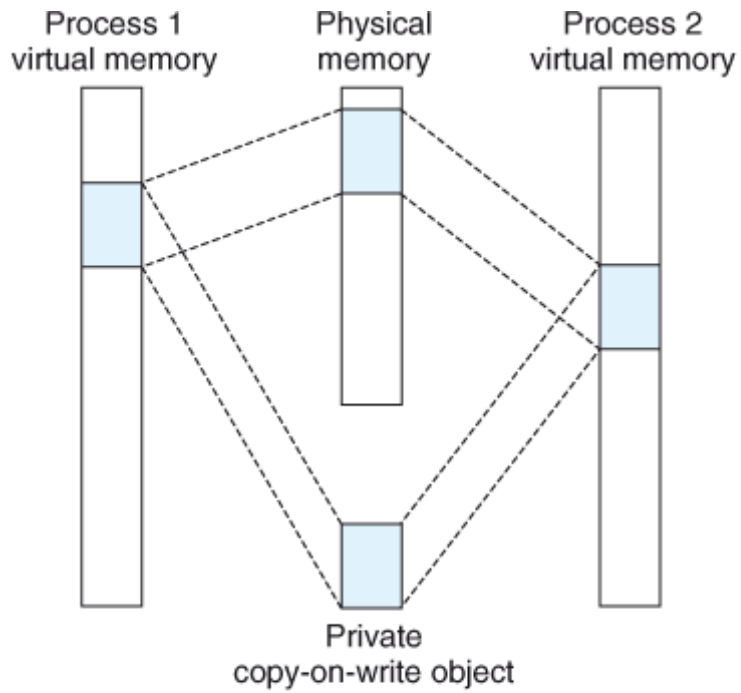


(b)

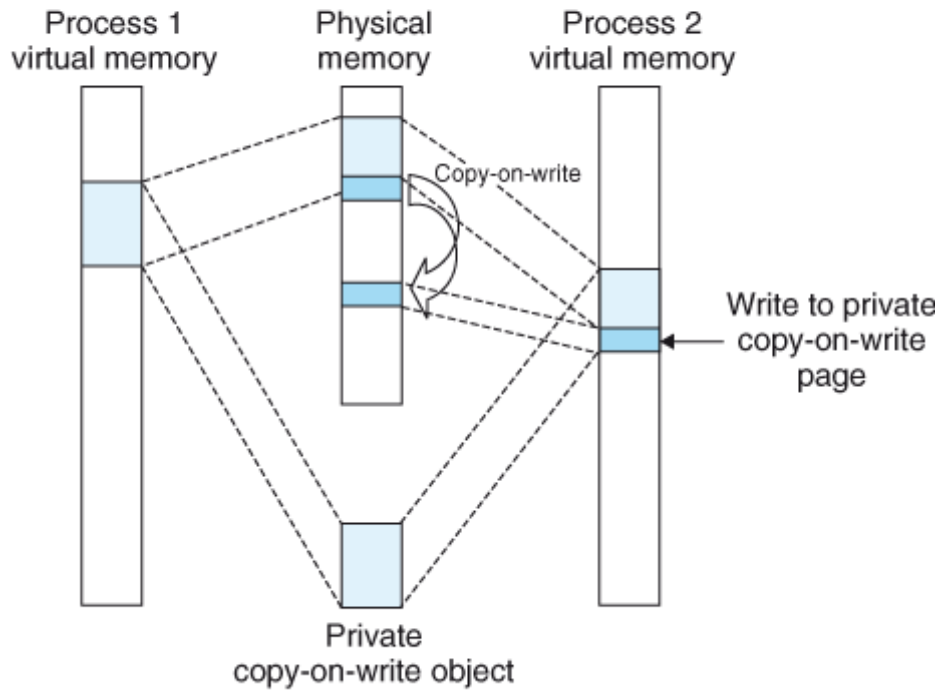
Figure 9.29 A shared object.



(a) After process 1 maps the shared object, (b) After process 2 maps the same shared object. (Note that the physical pages are not necessarily contiguous.)




(a)




(b)

Figure 9.30 A private copy-on-write object.


(a) After both processes have mapped the private copy-on-write object, (b) After process 2 writes to a page in the private area.

into its address space (not necessarily at the same virtual address as process 1), as shown in [Figure 9.29\(b\)](#) .

Since each object has a unique filename, the kernel can quickly determine that process 1 has already mapped this object and can point the page table entries in process 2 to the appropriate physical pages. The key point is that only a single copy of the shared object needs to be stored in physical memory, even though the object is mapped into multiple shared areas. For convenience, we have shown the physical pages as being contiguous, but of course this is not true in general.

Private objects are mapped into virtual memory using a clever technique known as *copy-on-write*. A private object begins life in exactly the same way as a shared object, with only one copy of the private object stored in physical memory. For example, [Figure 9.30\(a\)](#)  shows a case where two processes have mapped a private object into different areas of their virtual memories but share the same physical copy of the object. For each process that maps the private object, the page table entries for the corresponding private area are flagged as read-only, and the area struct is flagged as *private copy-on-write*. So long as neither process attempts to write to its respective private area, they continue to share a single copy of the object in physical memory. However, as soon as a

process attempts to write to some page in the private area, the write triggers a protection fault.

When the fault handler notices that the protection exception was caused by the process trying to write to a page in a private copy-on-write area, it creates a new copy of the page in physical memory, updates the page table entry to point to the new copy, and then restores write permissions to the page, as shown in **Figure 9.30(b)** . When the fault handler returns, the CPU re-executes the write, which now proceeds normally on the newly created page.

By deferring the copying of the pages in private objects until the last possible moment, copy-on-write makes the most efficient use of scarce physical memory.

## 9.8.2 The `fork` Function Revisited

Now that we understand virtual memory and memory mapping, we can get a clear idea of how the `fork` function creates a new process with its own independent virtual address space.

When the `fork` function is called by the *current process*, the kernel creates various data structures for the *new process* and assigns it a unique PID. To create the virtual memory for the new process, it creates exact copies of the current process's `mm_struct`, area structs, and page tables. It flags each page in both processes as read-only, and flags each area struct in both processes as private copy-on-write.

When the `fork` returns in the new process, the new process now has an exact copy of the virtual memory as it existed when the fork was called. When either of the processes performs any subsequent writes, the copy-on-write mechanism creates new pages, thus preserving the abstraction of a private address space for each process.

## 9.8.3 The `execve` Function Revisited

Virtual memory and memory mapping also play key roles in the process of loading programs into memory. Now that we understand these concepts, we can understand how the `execve` function really loads and executes programs. Suppose that the program running in the current process makes the following call:

```
execve("a.out", NULL, NULL);
```

As you learned in [Chapter 8](#), the `execve` function loads and runs the program contained in the executable object file `a.out` within the current process, effectively replacing the current program with the `a.out` program. Loading and running `a.out` requires the following steps:

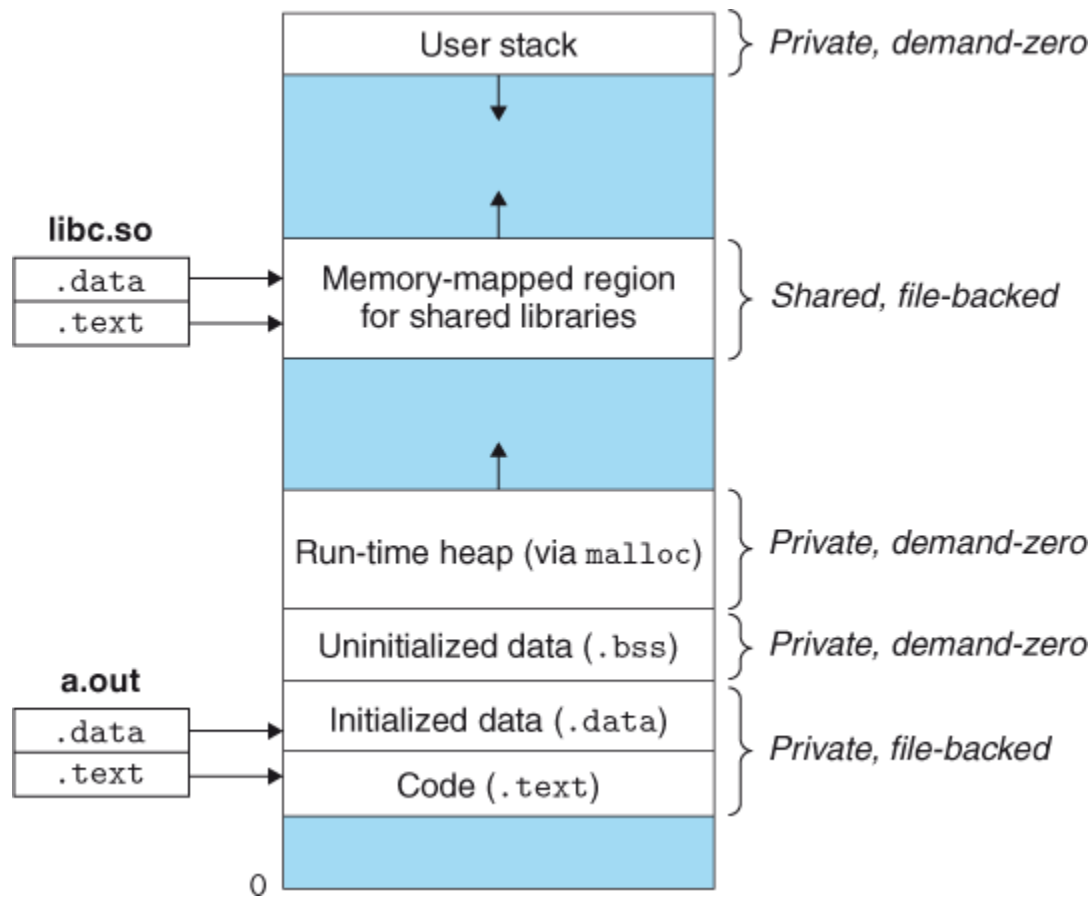



Figure 9.31 How the loader maps the areas of the user address space.

1. **Delete existing user areas.** Delete the existing area structs in the user portion of the current process's virtual address.
2. **Map private areas.** Create new area structs for the code, data, bss, and stack areas of the new program. All of these new areas are private copy-on-write. The code and data areas are mapped to the `.text` and `.data` sections of the `a.out` file. The bss area is demand-zero, mapped to an anonymous file whose size is contained in `a.out`. The stack and heap area are also demand-zero, initially of zero length.

**Figure 9.31**  summarizes the different mappings of the private areas.

- 3. Map shared areas.** If the `a.out` program was linked with shared objects, such as the standard C library `libc.so`, then these objects are dynamically linked into the program, and then mapped into the shared region of the user's virtual address space.
- 4. Set the program counter (PC).** The last thing that `execve` does is to set the program counter in the current process's context to point to the entry point in the code area.

The next time this process is scheduled, it will begin execution from the entry point. Linux will swap in code and data pages as needed.



## 9.8.4 User-Level Memory

# Mapping with the `mmap` Function

Linux processes can use the `mmap` function to create new areas of virtual memory and to map objects into these areas.

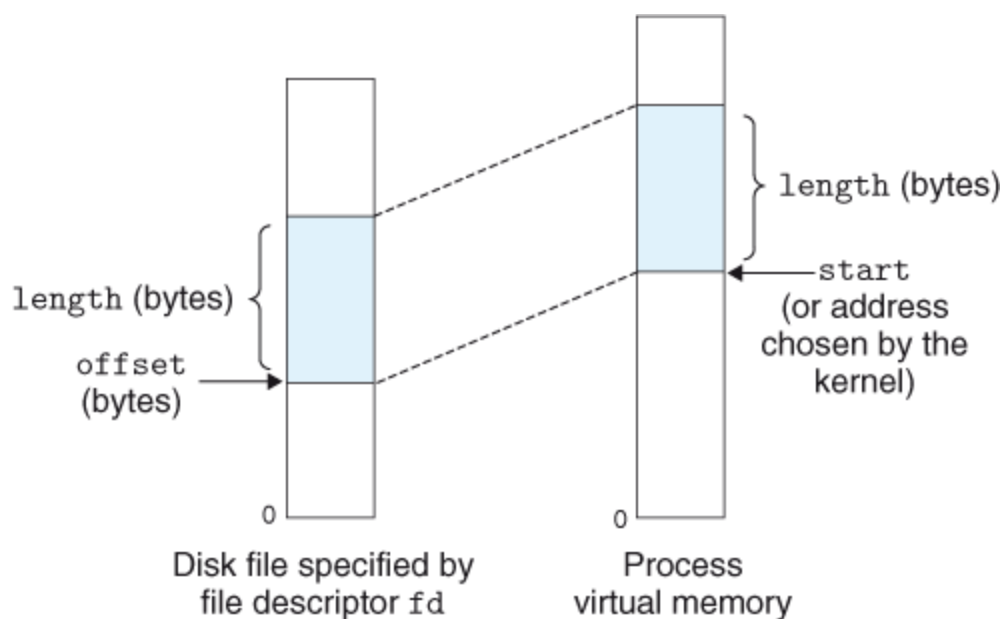



Figure 9.32 Visual interpretation of `mmap` arguments.

```

|
#include <unistd.h>
#include <sys/mman.h>

void *mmap(void *start, size_t length, int prot, int flags,
           int fd, off_t offset);
           Returns: pointer to mapped area
if OK, MAP_FAILED (-1) on error

```

The `mmap` function asks the kernel to create a new virtual memory area, preferably one that starts at address `start`, and to map a contiguous chunk of the object specified by file descriptor `fd` to the new area. The contiguous object chunk has a size of `length` bytes and starts at an `offset` of offset bytes from the beginning of the file. The `start` address is merely a hint, and is usually specified as NULL. For our purposes, we will always assume a NULL start address. **Figure 9.32**  depicts the meaning of these arguments.

The `prot` argument contains bits that describe the access permissions of the newly mapped virtual memory area (i.e., the `vm_prot` bits in the corresponding area struct).

**PROT\_EXEC.** Pages in the area consist of instructions that may be executed by the CPU.

**PROT\_READ.** Pages in the area may be read.

**PROT\_WRITE.** Pages in the area may be written.

**PROT\_NONE.** Pages in the area cannot be accessed.

The `flags` argument consists of bits that describe the type of the mapped object. If the `MAP_ANON` flag bit is set, then the backing store is an anonymous object and the corresponding virtual pages are demand-zero. `MAP_PRIVATE` indicates a private copy-on-write object, and `MAP_SHARED` indicates a shared object. For example,

```
|  
bufp = Mmap(NULL, size, PROT_READ, MAP_PRIVATE|MAP_ANON, 0, 0);
```

asks the kernel to create a new read-only, private, demand-zero area of virtual memory containing `size` bytes. If the call is successful, then `bufp` contains the address of the new area.

The `munmap` function deletes regions of virtual memory:

```
|  
#include <unistd.h>  
#include <sys/mman.h>  
  
int munmap(void *start, size_t length);  
  
Returns: 0 if OK, -1 on error
```

The `munmap` function deletes the area starting at virtual address `start` and consisting of the next `length` bytes. Subsequent references to the deleted region result in segmentation faults.

## *Practice Problem 9.5 (solution page **882**)*

Write a C program `mmapcopy.c` that uses `mmap` to copy an arbitrary-size disk file to `stdout`. The name of the input file should be passed as a command-line argument.

[OceanofPDF.com](http://OceanofPDF.com)

## 9.9 Dynamic Memory Allocation

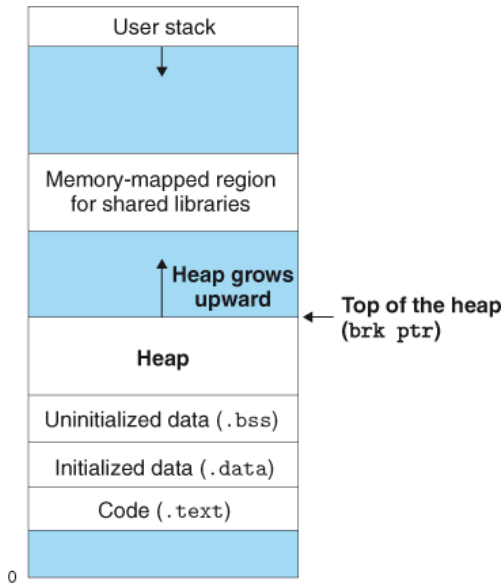
While it is certainly possible to use the low-level `mmap` and `munmap` functions to create and delete areas of virtual memory, C programmers typically find it more convenient and more portable to use a *dynamic memory allocator* when they need to acquire additional virtual memory at run time.

A dynamic memory allocator maintains an area of a process's virtual memory known as the *heap* (Figure 9.33). Details vary from system to system, but without loss of generality, we will assume that the heap is an area of demand-zero memory that begins immediately after the uninitialized data area and grows upward (toward higher addresses). For each process, the kernel maintains a variable `brk` (pronounced "break") that points to the top of the heap.

An allocator maintains the heap as a collection of various-size *blocks*. Each block is a contiguous chunk of virtual memory that is either *allocated* or *free*. An allocated block has been explicitly reserved for use by the application. A free block is available to be allocated. A free block remains free until it is explicitly allocated by the application. An allocated block remains allocated until it is freed, either explicitly by the application or implicitly by the memory allocator itself.

Allocators come in two basic styles. Both styles require the application to explicitly allocate blocks. They differ about which entity is responsible for freeing allocated blocks.

- **Explicit allocators** require the application to explicitly free any allocated blocks. For example, the C standard library provides an explicit allocator called the `malloc` package. C programs allocate a block by calling the `malloc`



**Figure 9.33** The heap.

function, and free a block by calling the free function. The `new` and `delete` calls in `C++` are comparable.

- **Implicit allocators**, on the other hand, require the allocator to detect when an allocated block is no longer being used by the program and then free the block. Implicit allocators are also known as *garbage collectors*, and the process of automatically freeing unused allocated blocks is known as *garbage collection*. For example, higher-level languages such as Lisp, ML, and Java rely on garbage collection to free allocated blocks.

The remainder of this section discusses the design and implementation of explicit allocators. We will discuss implicit allocators in [Section 9.10](#). For concrete -ness, our discussion focuses on allocators that manage heap memory. However, you should be aware that memory allocation is a general idea that arises in a variety of contexts. For example, applications that do intensive manipulation of graphs will often use the standard allocator to acquire a large block of virtual memory and then use an application-specific allocator to manage the memory within that block as the nodes of the graph are created and destroyed.

## 9.9.1 The `malloc` and `free` Functions

The C standard library provides an explicit allocator known as the `malloc` package. Programs allocate blocks from the heap by calling the `malloc` function.

```
|  
#include <stdlib.h>  
  
void *malloc(size_t size);  
Returns: pointer to allocated block if OK, NULL on error
```

### Aside How big is a word?

Recall from our discussion of machine code in [Chapter 3](#) that Intel refers to 4-byte objects as *double words*. However, throughout this section, we will assume that *words* are 4-byte objects and that *double words* are 8-byte objects, which is consistent with conventional terminology.

The `malloc` function returns a pointer to a block of memory of at least `size` bytes that is suitably aligned for any kind of data object that might be contained in the block. In practice, the alignment depends on whether the code is compiled to run in 32-bit mode (`gcc -m32`) or 64-bit mode (the default). In 32-bit mode, `malloc` returns a block whose address is always a multiple of 8. In 64-bit mode, the address is always a multiple of 16.

If `malloc` encounters a problem (e.g., the program requests a block of memory that is larger than the available virtual memory), then it returns NULL and sets `errno`. `malloc` does not initialize the memory it returns. Applications that want initialized dynamic memory can use `calloc`, a thin wrapper around the `malloc` function that initializes the allocated memory to `zero`. Applications that want to change the size of a previously allocated block can use the `realloc` function.

Dynamic memory allocators such as `malloc` can allocate or deallocate heap memory explicitly by using the `mmap` and `munmap` functions, or they can use the `sbrk` function:

```
|  
#include <unistd.h>  
  
void *sbrk(intptr_t incr);  
Returns: old brk pointer on success, -1 on error
```

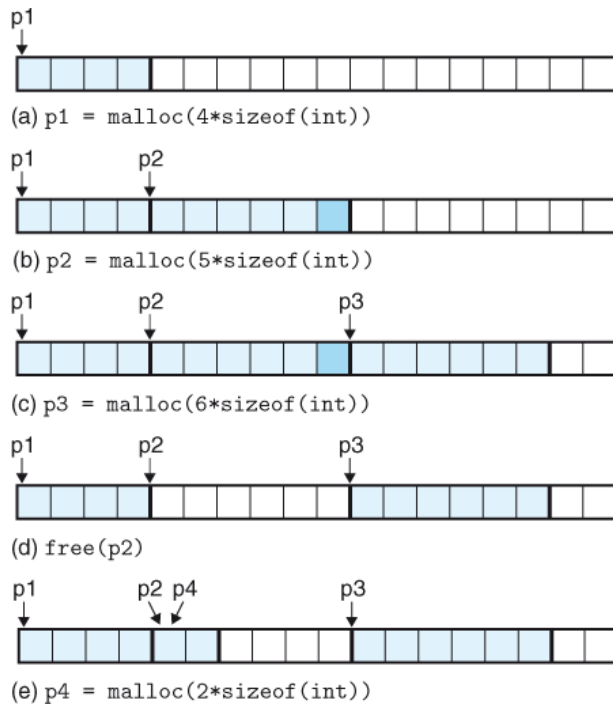
The `sbrk` function grows or shrinks the heap by adding `incr` to the kernel's `brk` pointer. If successful, it returns the old value of `brk`, otherwise it returns `-1` and sets `errno` to `ENOMEM`. If `incr` is zero, then `sbrk` returns the current value of `brk`. Calling `sbrk` with a negative `incr` is legal but tricky because the return value (the old value of `brk`) points to `abs (incr)` bytes past the new top of the heap.

Programs free allocated heap blocks by calling the `free` function.

```
|  
#include <stdlib.h>  
  
void free(void *ptr);  
Returns: nothing
```

The `ptr` argument must point to the beginning of an allocated block that was obtained from `malloc`, `calloc`, or `realloc`. If not, then the behavior of `free` is undefined. Even worse, since it returns nothing, `free` gives no indication to the application that something is wrong. As we shall see in [Section 9.11](#), this can produce some baffling run-time errors.





**Figure 9.34** Allocating and freeing blocks with `malloc` and `free`.

Each square corresponds to a word. Each heavy rectangle corresponds to a block. Allocated blocks are shaded. Padded regions of allocated blocks are shaded with a darker blue. Free blocks are unshaded. Heap addresses increase from left to right.

**Figure 9.34** shows how an implementation of `malloc` and `free` might manage a (very) small heap of 16 words for a C program. Each box represents a 4-byte word. The heavy-lined rectangles correspond to allocated blocks (shaded) and free blocks (unshaded). Initially, the heap consists of a single 16-word double-word-aligned free block.<sup>1</sup>


1. Throughout this section, we will assume that the allocator returns blocks aligned to 8-byte double-word boundaries.

**Figure 9.34(a)** . The program asks for a four-word block. `Malloc` responds by carving out a four-word block from the front of the free block and returning a pointer to the first word of the block.

**Figure 9.34(b)** . The program requests a five-word block. `Malloc` responds by allocating a six-word block from the front of the free block. In this example, `malloc` pads the block with an extra word in order to keep the free block aligned on a double-word boundary.

**Figure 9.34(c)** . The program requests a six-word block and `malloc` responds by carving out a six-word block from the free block.

**Figure 9.34(d)** . The program frees the six-word block that was allocated in **Figure 9.34(b)** . Notice that after the call to `free` returns, the pointer `p2` still points to the freed block. It is the responsibility of the application not to use `p2` again until it is reinitialized by a new call to `malloc`.

**Figure 9.34(e)** . The program requests a two-word block. In this case, `malloc` allocates a portion of the block that was freed in the previous step and returns a pointer to this new block.

## 9.9.2 Why Dynamic Memory Allocation?

The most important reason that programs use dynamic memory allocation is that often they do not know the sizes of certain data structures until the program actually runs. For example, suppose we are asked to write a C program that reads a list of  $n$  ASCII integers, one integer per line, from `stdin` into a C array. The input consists of the integer  $n$ , followed by the  $n$  integers to be read and stored into the array. The simplest approach is to define the array statically with some hard-coded maximum array size:

```
1  #include "csapp.h"
2  #define MAXN 15213
3
4  int array [MAXN];
5
6  int main()
7  {
8      int i, n;
9
10     scanf("%d", &n);
11     if (n > MAXN)
12         app_error("Input file too big");
13     for (i = 0; i < n; i++)
14         scanf ("%d", &array[i]);
15     exit(0);
16 }
```

Allocating arrays with hard-coded sizes like this is often a bad idea. The value of `MAXN` is arbitrary and has no relation to the actual amount of available virtual memory on the machine. Further, if the user of this program wanted to read a file that was larger than `MAXN`, the only recourse would be to recompile the program with a larger value of `MAXN`. While not a problem for this simple example, the presence of hard-coded array bounds can become a maintenance nightmare for large software products with millions of lines of code and numerous users.

A better approach is to allocate the array dynamically, at run time, after the value of  $n$  becomes known. With this approach, the maximum size of the array is limited only by the amount of available virtual memory.

```
|
1  #include "csapp.h"
2
3  int main()
4  {
5      int *array, i, n;
6
7      scanf ("%d", &n);
8      array = (int *)Malloc(n * sizeof(int));
9      for (i = 0; i < n; i++)
10         scanf ("%d", &array[i]);
11     free(array);
12     exit(0);
13 }
```

Dynamic memory allocation is a useful and important programming technique. However, in order to use allocators correctly and efficiently, programmers need to have an understanding of how they work. We will discuss some of the gruesome errors that can result from the improper use of allocators in [Section 9.11](#).

## 9.9.3 Allocator Requirements and Goals

Explicit allocators must operate within some rather stringent constraints:

**Handling arbitrary request sequences.** An application can make an arbitrary sequence of allocate and free requests, subject to the constraint that each free request must correspond to a currently allocated block obtained from a previous allocate request. Thus, the allocator cannot make any assumptions about the ordering of allocate and free requests. For example, the allocator cannot assume that all allocate requests are accompanied by a matching free request, or that matching allocate and free requests are nested.

**Making immediate responses to requests.** The allocator must respond immediately to allocate requests. Thus, the allocator is not allowed to reorder or buffer requests in order to improve performance.

**Using only the heap.** In order for the allocator to be scalable, any nonscalar data structures used by the allocator must be stored in the heap itself.

**Aligning blocks (alignment requirement).** The allocator must align blocks in such a way that they can hold any type of data object.

**Not modifying allocated blocks.** Allocators can only manipulate or change free blocks. In particular, they are not allowed to modify or move blocks once they are allocated. Thus, techniques such as compaction of allocated blocks are not permitted.

Working within these constraints, the author of an allocator attempts to meet the often conflicting performance goals of maximizing throughput and memory utilization.

**Goal 1: Maximizing throughput.** Given some sequence of  $n$  allocate and free requests

$$R_0, R_1, \dots, R_k, \dots, R_{n-1}$$

we would like to maximize an allocator's *throughput*, which is defined as the number of requests that it completes per unit time. For example, if an allocator completes 500 allocate requests and 500 free requests in 1 second, then its throughput is 1,000 operations per second. In general, we can maximize throughput by minimizing the average time to satisfy allocate and free requests. As we'll see, it is not too difficult to develop allocators with reasonably good performance where the worst-case running time of an allocate request is linear in the number of free blocks and the running time of a free request is constant.

**Goal 2: Maximizing memory utilization.** Naive programmers often incorrectly assume that virtual memory is an unlimited resource. In fact, the total amount of virtual memory allocated by all of the processes in a system is limited by the amount of swap space on disk. Good programmers know that

virtual memory is a finite resource that must be used efficiently. This is especially true for a dynamic memory allocator that might be asked to allocate and free large blocks of memory.

There are a number of ways to characterize how efficiently an allocator uses the heap. In our experience, the most useful metric is *peak utilization*. As before, we are given some sequence of  $n$  allocate and free requests

$$R_0, R_1, \dots, R_k, \dots, R_{n-1}$$

If an application requests a block of  $p$  bytes, then the resulting allocated block has a *payload* of  $p$  bytes. After request  $R_k$  has completed, let the *aggregate payload*, denoted  $P_k$ , be the sum of the payloads of the currently allocated blocks, and let  $H_k$  denote the current (monotonically nondecreasing) size of the heap.

Then the peak utilization over the first  $k + 1$  requests, denoted by  $U_k$ , is given by

$$U_k = \frac{\max_{i \leq k} P_i}{H_k}$$

The objective of the allocator, then, is to maximize the peak utilization  $U_{n-1}$  over the entire sequence. As we will see, there is a tension between maximizing throughput and utilization. In particular, it is easy to write an allocator that maximizes throughput at the expense of heap utilization. One of the interesting challenges in any allocator design is finding an appropriate balance between the two goals.

## Aside Relaxing the monotonicity assumption

We could relax the monotonically nondecreasing assumption in our definition of  $U_k$  and allow the heap to grow up and down by letting  $H_k$  be the high-water mark over the first  $k + 1$  requests.

## 9.9.4 Fragmentation

The primary cause of poor heap utilization is a phenomenon known as *fragmentation*, which occurs when otherwise unused memory is not available to satisfy allocate requests. There are two forms of fragmentation: *internal fragmentation* and *external fragmentation*.

*Internal fragmentation* occurs when an allocated block is larger than the pay-load. This might happen for a number of reasons. For example, the implementation of an allocator might impose a minimum size on allocated blocks that is greater than some requested payload. Or, as we saw in [Figure 9.34\(b\)](#), the allocator might increase the block size in order to satisfy alignment constraints.

Internal fragmentation is straightforward to quantify. It is simply the sum of the differences between the sizes of the allocated blocks and their payloads. Thus, at any point in time, the amount of internal fragmentation depends only on the pattern of previous requests and the allocator implementation.

*External fragmentation* occurs when there *is* enough aggregate free memory to satisfy an allocate request, but no single free block is large enough to handle the request. For example, if the request in [Figure 9.34\(e\)](#) were for eight words rather than two words, then the request could not be satisfied without requesting additional virtual memory from the kernel, even though there are eight free words remaining in the heap. The problem arises because these eight words are spread over two free blocks.

External fragmentation is much more difficult to quantify than internal fragmentation because it depends not only on the pattern of previous requests and the allocator implementation but also on the pattern of *future* requests. For example, suppose that after  $k$  requests all of the free blocks are exactly four words in size. Does this heap suffer from external fragmentation? The answer depends on the pattern of future requests. If all of the future allocate requests are for blocks that are smaller than or equal to four words, then there is no external fragmentation. On the other hand, if one or more requests ask for blocks larger than four words, then the heap does suffer from external fragmentation.

Since external fragmentation is difficult to quantify and impossible to predict, allocators typically employ heuristics that attempt to maintain small numbers of larger free blocks rather than large numbers of smaller free blocks.

## 9.9.5 Implementation Issues

The simplest imaginable allocator would organize the heap as a large array of bytes and a pointer `p` that initially points to the first byte of the array. To allocate `size` bytes, `malloc` would save the current value of `p` on the stack, increment `p` by `size`, and return the old value of `p` to the caller. `Free` would simply return to the caller without doing anything.

This naive allocator is an extreme point in the design space. Since each `malloc` and `free` execute only a handful of instructions, throughput would be extremely good. However, since the allocator never reuses any blocks, memory utilization would be extremely bad. A practical allocator that strikes a better balance between throughput and utilization must consider the following issues:

**Free block organization.** How do we keep track of free blocks?

**Placement.** How do we choose an appropriate free block in which to place a newly allocated block?

**Splitting.** After we place a newly allocated block in some free block, what do we do with the remainder of the free block?

**Coalescing.** What do we do with a block that has just been freed?

The rest of this section looks at these issues in more detail. Since the basic techniques of placement, splitting, and coalescing cut across many different free block organizations, we will introduce them in the context of a simple free block organization known as an implicit free list.



## 9.9.6 Implicit Free Lists

Any practical allocator needs some data structure that allows it to distinguish block boundaries and to distinguish between allocated and free blocks. Most allocators embed this information in the blocks themselves. One simple approach is shown in [Figure 9.35](#).

In this case, a block consists of a one-word *header*, the payload, and possibly some additional *padding*. The header encodes the block size (including the header and any padding) as well as whether the block is allocated or free. If we impose a double-word alignment constraint, then the block size is always a multiple of 8 and the 3 low-order bits of the block size are always zero. Thus, we need to store only the 29 high-order bits of the block size, freeing the remaining 3 bits to encode other information. In this case, we are using the least significant of these bits

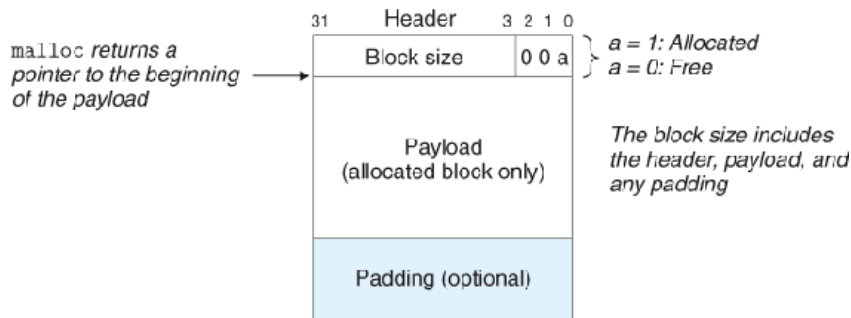


Figure 9.35 Format of a simple heap block.

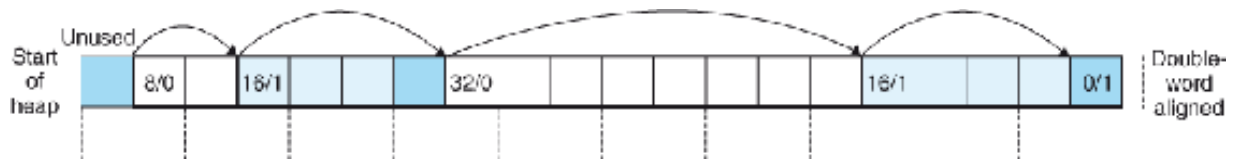


Figure 9.36 Organizing the heap with an implicit free list.

Allocated blocks are shaded. Free blocks are unshaded. Headers are labeled with (size (bytes)/allocated bit).

(the *allocated bit*) to indicate whether the block is allocated or free. For example, suppose we have an allocated block with a block size of 24 (`0x18`) bytes. Then its header would be

```
|
| 0x00000018 | 0x1 = 0x00000019
```

Similarly, a free block with a block size of 40 (`0x28`) bytes would have a header of

```
0x00000028 | 0x0 = 0x00000028
```

The header is followed by the payload that the application requested when it called `malloc`. The payload is followed by a chunk of unused padding that can be any size. There are a number of reasons for the padding. For example, the padding might be part of an allocator's strategy for combating external fragmentation. Or it might be needed to satisfy the alignment requirement.

Given the block format in [Figure 9.35](#), we can organize the heap as a sequence of contiguous allocated and free blocks, as shown in [Figure 9.36](#).

We call this organization an *implicit free list* because the free blocks are linked implicitly by the size fields in the headers. The allocator can indirectly traverse the entire set of free blocks by traversing *all* of the blocks in the heap. Notice that we need some kind of specially marked end block—in this example, a terminating header with the allocated bit set and a size of zero. (As we will see in [Section 9.9.12](#), setting the allocated bit simplifies the coalescing of free blocks.)

The advantage of an implicit free list is simplicity. A significant disadvantage is that the cost of any operation that requires a search of the free list, such as placing allocated blocks, will be linear in the *total* number of allocated and free blocks in the heap.

It is important to realize that the system's alignment requirement and the allocator's choice of block format impose a *minimum block size* on the allocator. No allocated or free block may be smaller than this minimum. For example, if we assume a double-word alignment requirement, then the size of each block must be a multiple of two words (8 bytes). Thus, the block format in [Figure 9.35](#) induces a minimum block size of two words: one word for the header and another to maintain the alignment requirement. Even if the application were to request a single byte, the allocator would still create a two-word block.

## *Practice Problem 9.6 (solution page 883)*

Determine the block sizes and header values that would result from the following sequence of `malloc` requests. Assumptions: (1) The allocator maintains double-word alignment and uses an implicit free list with the block format from [Figure 9.35](#). (2) Block sizes are rounded up to the nearest multiple of 8 bytes.

## 9.9.7 Placing Allocated Blocks

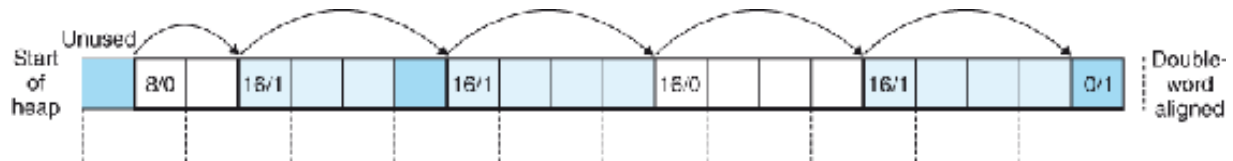
When an application requests a block of  $k$  bytes, the allocator searches the free list for a free block that is large enough to hold the requested block. The manner in which the allocator performs this search is determined by the *placement policy*. Some common policies are first fit, next fit, and best fit.

*First fit* searches the free list from the beginning and chooses the first free block that fits. *Next fit* is similar to first fit, but instead of starting each search at the beginning of the list, it starts each search where the previous search left off. *Best fit* examines every free block and chooses the free block with the smallest size that fits.

An advantage of first fit is that it tends to retain large free blocks at the end of the list. A disadvantage is that it tends to leave "splinters" of small free blocks toward the beginning of the list, which will increase the search time for larger blocks. Next fit was first proposed by Donald Knuth as an alternative to first fit, motivated by the idea that if we found a fit in some free block the last time, there is a good chance that we will find a fit the next time in the remainder of the block. Next fit can run significantly faster than first fit, especially if the front of the list becomes littered with many small splinters. However, some studies suggest that next fit suffers from worse memory utilization than first fit. Studies have found that best fit generally enjoys better memory utilization than either first fit or next fit. However, the disadvantage of using best fit with simple free list organizations such as the implicit free list is that it requires an exhaustive search of the heap. Later, we will look at more sophisticated segregated free list organizations that approximate a best-fit policy without an exhaustive search of the heap.

## 9.9.8 Splitting Free Blocks

Once the allocator has located a free block that fits, it must make another policy decision about how much of the free block to allocate. One option is to use the entire free block. Although simple and fast, the main disadvantage is that it



**Figure 9.37 Splitting a free block to satisfy a three-word allocation request.**

Allocated blocks are shaded. Free blocks are unshaded. Headers are labeled with (size (bytes)/allocated bit).

introduces internal fragmentation. If the placement policy tends to produce good fits, then some additional internal fragmentation might be acceptable.

However, if the fit is not good, then the allocator will usually opt to *split* the free block into two parts. The first part becomes the allocated block, and the remainder becomes a new free block. [Figure 9.37](#) shows how the allocator might split the eight-word free block in [Figure 9.36](#) to satisfy an application's request for three words of heap memory.

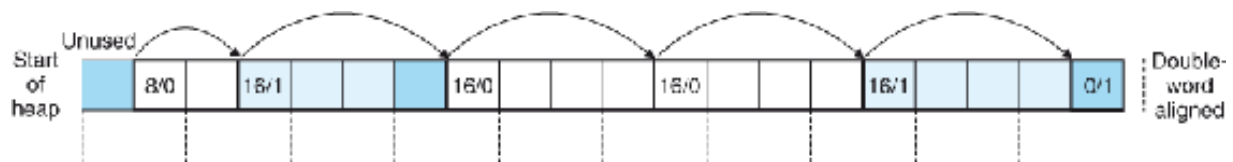
## 9.9.9 Getting Additional Heap Memory

What happens if the allocator is unable to find a fit for the requested block? One option is to try to create some larger free blocks by merging (coalescing) free blocks that are physically adjacent in memory (next section). However, if this does not yield a sufficiently large block, or if the free blocks are already maximally coalesced, then the allocator asks the kernel for additional heap memory by calling the `sbrk` function. The allocator transforms the additional memory into one large free block, inserts the block into the free list, and then places the requested block in this new free block.

## 9.9.10 Coalescing Free Blocks

When the allocator frees an allocated block, there might be other free blocks that are adjacent to the newly freed block. Such adjacent free blocks can cause a phenomenon known as, *false fragmentation*, where there is a lot of available free memory chopped up into small, unusable free blocks. For example, [Figure 9.38](#) shows the result of freeing the block that was allocated in [Figure 9.37](#). The result is two adjacent free blocks with payloads of three words each. As a result, a subsequent request for a payload of four words would fail, even though the aggregate size of the two free blocks is large enough to satisfy the request.

To combat false fragmentation, any practical allocator must merge adjacent free blocks in a process known as *coalescing*. This raises an important policy decision about when to perform coalescing. The allocator can opt for *immediate coalescing* by merging any adjacent blocks each time a block is freed. Or it can opt for *deferred coalescing* by waiting to coalesce free blocks at some later time. For example, the allocator might defer coalescing until some allocation request fails, and then scan the entire heap, coalescing all free blocks.



**Figure 9.38** An example of false fragmentation.

Allocated blocks are shaded. Free blocks are unshaded. Headers are labeled with (size (bytes)/allocated bit).

Immediate coalescing is straightforward and can be performed in constant time, but with some request patterns it can introduce a form of thrashing where a block is repeatedly coalesced and then split soon thereafter. For example, in [Figure 9.38](#), a repeated pattern of allocating and freeing a three-word block would introduce a lot of unnecessary splitting and coalescing. In our discussion of allocators, we will assume immediate coalescing, but you should be aware that fast allocators often opt for some form of deferred coalescing.

## 9.9.11 Coalescing with Boundary Tags

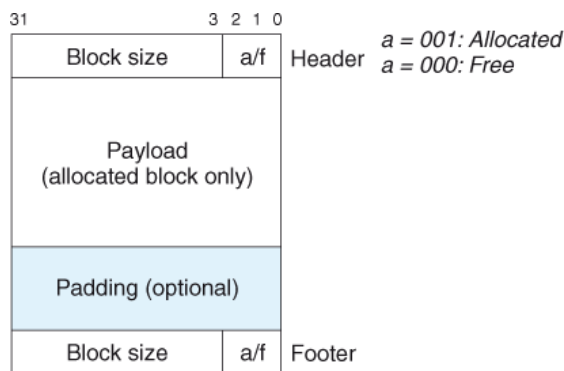
How does an allocator implement coalescing? Let us refer to the block we want to free as the *current block*. Then coalescing the next free block (in memory) is straightforward and efficient. The header of the current block points to the header of the next block, which can be checked to determine if the next block is free. If so, its size is simply added to the size of the current header and the blocks are coalesced in constant time.

But how would we coalesce the previous block? Given an implicit free list of blocks with headers, the only option would be to search the entire list, remembering the location of the previous block, until we reached the current block. With an implicit free list, this means that each call to free would require time linear in the size of the heap. Even with more sophisticated free list organizations, the search time would not be constant.

Knuth developed a clever and general technique, known as *boundary tags*, that allows for constant-time coalescing of the previous block. The idea, which is shown in [Figure 9.39](#), is to add a *footer* (the boundary tag) at the end of each block, where the footer is a replica of the header. If each block includes such a footer, then the allocator can determine the starting location and status of the previous block by inspecting its footer, which is always one word away from the start of the current block.

Consider all the cases that can exist when the allocator frees the current block:

1. The previous and next blocks are both allocated.
2. The previous block is allocated and the next block is free.
3. The previous block is free and the next block is allocated.
4. The previous and next blocks are both free.



**Figure 9.39** Format of heap block that uses a boundary tag.

[Figure 9.40](#) shows how we would coalesce each of the four cases.

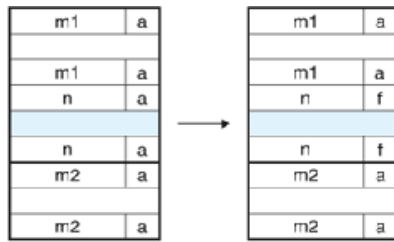
In case 1, both adjacent blocks are allocated and thus no coalescing is possible. So the status of the current block is simply changed from allocated to free. In case 2, the current block is merged with the next block. The header of the current block and the footer of the next block are updated with the combined sizes of the current and next blocks. In case 3, the previous block is merged with the current block. The header of the previous block and the footer of the current block are updated with the combined sizes of the two blocks. In case 4, all three blocks are merged to form a single free block, with the header of the previous block and the footer of the next block updated with the combined sizes of the three blocks. In each case, the coalescing is performed in constant time.

The idea of boundary tags is a simple and elegant one that generalizes to many different types of allocators and free list organizations. However, there is a potential disadvantage. Requiring each block to contain both a header and a footer can introduce significant memory overhead if an application manipulates many small blocks. For example, if a graph application dynamically creates and destroys graph nodes by making repeated calls to `malloc` and `free`, and each graph node requires only a couple of words of memory, then the header and the footer will consume half of each allocated block.

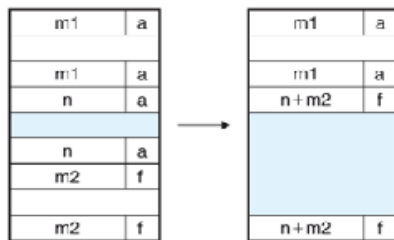
Fortunately, there is a clever optimization of boundary tags that eliminates the need for a footer in allocated blocks. Recall that when we attempt to coalesce the current block with the previous and next blocks in memory, the size field in the footer of the previous block is only needed if the previous block is *free*. If we were to store the allocated/free bit of the previous block in one of the excess low-order bits of the current block, then allocated blocks would not need footers, and we could use that extra space for payload. Note, however, that free blocks would still need footers.

## Practice Problem 9.7 (solution page 883)

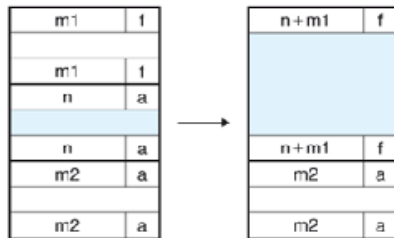
Determine the minimum block size for each of the following combinations of alignment requirements and block formats. Assumptions: Implicit free list, zero-size payloads are not allowed, and headers and footers are stored in 4-byte words.



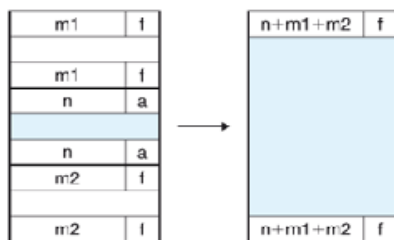
Case 1



Case 2



Case 3



Case 4

**Figure 9.40 Coalescing with boundary tags.**

Case 1 : prev and next allocated. Case 2: prev allocated, next free. Case 3: prev free, next allocated. Case 4: next and prev free.



## 9.9.12 Putting It Together: Implementing a Simple Allocator

Building an allocator is a challenging task. The design space is large, with numerous alternatives for block format and free list format, as well as placement, splitting, and coalescing policies. Another challenge is that you are often forced to program outside the safe, familiar confines of the type system, relying on the error-prone pointer casting and pointer arithmetic that is typical of low-level systems programming.

While allocators do not require enormous amounts of code, they are subtle and unforgiving. Students familiar with higher-level languages such as C++ or Java often hit a conceptual wall when they first encounter this style of programming. To help you clear this hurdle, we will work through the implementation of a simple allocator based on an implicit free list with immediate boundary-tag coalescing. The maximum block size is  $2^{32} = 4$  GB. The code is 64-bit clean, running without modification in 32-bit (`gcc -m32`) or 64-bit (`gcc -m64`) processes.

## General Allocator Design

Our allocator uses a model of the memory system provided by the `memlib.c` package shown in [Figure 9.41](#). The purpose of the model is to allow us to run our allocator without interfering with the existing system-level `malloc` package.

The `mem_init` function models the virtual memory available to the heap as a large double-word aligned array of bytes. The bytes between `mem_heap` and `mem_brk` represent allocated virtual memory. The bytes following `mem_brk` represent unallocated virtual memory. The allocator requests additional heap memory by calling the `mem_sbrk` function, which has the same interface as the system's `sbrk` function, as well as the same semantics, except that it rejects requests to shrink the heap.

The allocator itself is contained in a source file (`mm.c`) that users can compile and link into their applications. The allocator exports three functions to application programs:

```
1 extern int mm_init(void);
2 extern void *mm_malloc (size_t size);
3 extern void mm_free (void *ptr);
```

The `mm_init` function initializes the allocator, returning 0 if successful and `-1` otherwise. The `mm_malloc` and `mm_free` functions have the same interfaces and semantics as their system counterparts. The allocator uses the block format

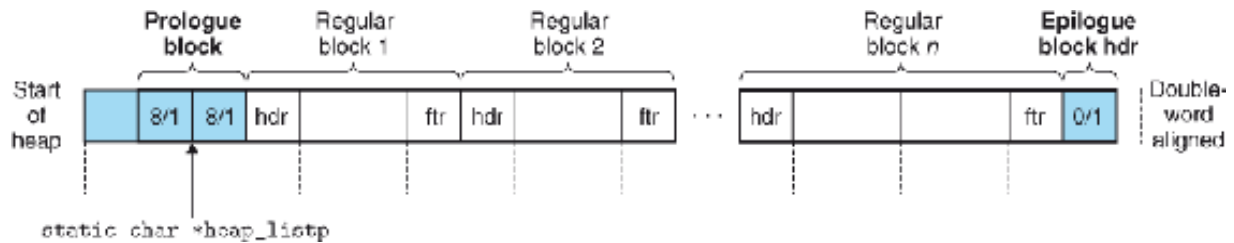
b.c

```
1  /* Private global variables */
2  static char *mem_heap;          /* Points to first byte of heap */
3  static char *mem_brk;          /* Points to last byte of heap plus 1 */
4  static char *mem_max_addr;     /* Max legal heap addr plus 1 */
5
6  /*
7   * mem_init - Initialize the memory system model
8   */
9  void mem_init(void)
10 {
11     mem_heap = (char *)Malloc(MAX_HEAP);
12     mem_brk = (char *)mem_heap;
13     mem_max_addr = (char *)(mem_heap + MAX_HEAP);
14 }
15
16 /*
17 * mem_sbrk - Simple model of the sbrk function. Extends the heap
18 *   by incr bytes and returns the start address of the new area. In
19 *   this model, the heap cannot be shrunk.
20 */
21 void *mem_sbrk(int incr)
22 {
23     char *old_brk = mem_brk;
24
25     if ( (incr < 0) || ((mem_brk + incr) > mem_max_addr) ) {
26         errno = ENOMEM;
27         fprintf(stderr, "ERROR: mem_sbrk failed. Ran out of memory...\n");
28         return (void *)-1;
29     }
30     mem_brk += incr;
31     return (void *)old_brk;
32 }
```

Figure 9.41 memlib. c: Memory system model.

shown in [Figure 9.39](#). The minimum block size is 16 bytes. The free list is organized as an implicit free list, with the invariant form shown in [Figure 9.42](#).


The first word is an unused padding word aligned to a double-word boundary. The padding is followed by a special *prologue block*, which is an 8-byte allocated block consisting of only a header and a footer. The prologue block is created during initialization and is never freed. Following the prologue block are zero or more regular blocks that are created by calls to `malloc` or `free`. The heap always ends with a special *epilogue block*, which is a zero-size allocated block



**Figure 9.42** Invariant form of the implicit free list.

that consists of only a header. The prologue and epilogue blocks are tricks that eliminate the edge conditions during coalescing. The allocator uses a single private (`static`) global variable (`heap_listp`) that always points to the prologue block. (As a minor optimization, we could make it point to the next block instead of the prologue block.)

## Basic Constants and Macros for Manipulating the Free List

Figure 9.43  shows some basic constants and macros that we will use throughout the allocator code. Lines 2–4 define some basic size constants: the sizes of words (WSIZE) and double words (DSIZE), and the size of the initial free block and the default size for expanding the heap (CHUNKSIZE).

Manipulating the headers and footers in the free list can be troublesome because it demands extensive use of casting and pointer arithmetic. Thus, we find it helpful to define a small set of macros for accessing and traversing the free list (lines 9–25). The PACK macro (line 9) combines a size and an allocate bit and returns a value that can be stored in a header or footer.

The GET macro (line 12) reads and returns the word referenced by argument `p`. The casting here is crucial. The argument `p` is typically a `(void *)` pointer, which cannot be dereferenced directly. Similarly, the PUT macro (line 13) stores `val` in the word pointed at by argument `p`.

The GET\_SIZE and GET\_ALLOC macros (lines 16–17) return the size and allocated bit, respectively, from a header or footer at address `p`. The remaining macros operate on *block pointers* (denoted `bp`) that point to the first payload byte. Given a block pointer `bp`, the HDRP and FTRP macros (lines 20–21) return pointers to the block header and footer, respectively. The NEXT\_BLK and PREV\_BLK macros (lines 24–25) return the block pointers of the next and previous blocks, respectively.

The macros can be composed in various ways to manipulate the free list. For example, given a pointer `bp` to the current block, we could use the following line of code to determine the size of the next block in memory:

```
size_t size = GET_SIZE(HDRP(NEXT_BLK(bp)));
```

C

```

1  /* Basic constants and macros */
2  #define WSIZE 4 /* Word and header/footer size (bytes) */
3  #define DSIZE 8 /* Double word size (bytes) */
4  #define CHUNKSIZE (1<<12) /* Extend heap by this amount (bytes) */
5
6  #define MAX(x, y) ((x) > (y)? (x) : (y))
7
8  /* Pack a size and allocated bit into a word */
9  #define PACK(size, alloc) ((size) | (alloc))
10
11 /* Read and write a word at address p */
12 #define GET(p) (*(unsigned int *)(p))
13 #define PUT(p, val) (*(unsigned int *)(p) = (val))
14
15 /* Read the size and allocated fields from address p */
16 #define GET_SIZE(p) (GET(p) & ~0x7)
17 #define GET_ALLOC(p) (GET(p) & 0x1)
18
19 /* Given block ptr bp, compute address of its header and footer */
20 #define HDRP(bp) ((char *) (bp) - WSIZE)
21 #define FTRP(bp) ((char *) (bp) + GET_SIZE(HDRP(bp)) - DSIZE)
22
23 /* Given block ptr bp, compute address of next and previous blocks */
24 #define NEXT_BLKP(bp) ((char *) (bp) + GET_SIZE(((char *) (bp) - WSIZE)))
25 #define PREV_BLKP(bp) ((char *) (bp) - GET_SIZE(((char *) (bp) - DSIZE)))

```

Figure 9.43 Basic constants and macros for manipulating the free list.

## Creating the Initial Free List

Before calling `mm_malloc` or `mm_free`, the application must initialize the heap by calling the `mm_init` function (Figure 9.44).

The `mm_init` function gets four words from the memory system and initializes them to create the empty free list (lines 4–10). It then calls the `extend_heap` function (Figure 9.45), which extends the heap by `CHUNKSIZE` bytes and creates the initial free block. At this point, the allocator is initialized and ready to accept allocate and free requests from the application.

The `extend_heap` function is invoked in two different circumstances: (1) when the heap is initialized and (2) when `mm_malloc` is unable to find a suitable fit. To maintain alignment, `extend_heap` rounds up the requested size to the nearest

---

`code/vm/malloc/mm.c`

```
1  int mm_init(void)
2  {
3      /* Create the initial empty heap */
4      if ((heap_listp = mem_sbrk(4*WSIZE)) == (void *)-1)
5          return -1;
6      PUT(heap_listp, 0);                          /* Alignment padding */
7      PUT(heap_listp + (1*WSIZE), PACK(DSIZE, 1)); /* Prologue header */
8      PUT(heap_listp + (2*WSIZE), PACK(DSIZE, 1)); /* Prologue footer */
9      PUT(heap_listp + (3*WSIZE), PACK(0, 1));      /* Epilogue header */
10     heap_listp += (2*WSIZE);
11
12     /* Extend the empty heap with a free block of CHUNKSIZE bytes */
13     if (extend_heap(CHUNKSIZE/WSIZE) == NULL)
14         return -1;
15     return 0;
16 }
```

---

`code/vm/malloc/mm.c`

Figure 9.44 `mm_init` creates a heap with an initial free block.

```
1 static void *extend_heap(size_t words)
2 {
3     char *bp;
4     size_t size;
5
6     /* Allocate an even number of words to maintain alignment */
7     size = (words % 2) ? (words+1) * WSIZE : words * WSIZE;
8     if ((long)(bp = mem_sbrk(size)) == -1)
9         return NULL;
10
11     /* Initialize free block header/footer and the epilogue header */
12     PUT(HDRP(bp), PACK(size, 0)); /* Free block header */
13     PUT(FTRP(bp), PACK(size, 0)); /* Free block footer */
14     PUT(HDRP(NEXT_BLKP(bp)), PACK(0, 1)); /* New epilogue header */
15
16     /* Coalesce if the previous block was free */
17     return coalesce(bp);
18 }
```

**Figure 9.45** `extend_heap` extends the heap with a new free block.

multiple of 2 words (8 bytes) and then requests the additional heap space from the memory system (lines 7–9).

The remainder of the `extend_heap` function (lines 12–17) is somewhat subtle. The heap begins on a double-word aligned boundary, and every call to `extend_heap` returns a block whose size is an integral number of double words. Thus, every call to `mem_sbrk` returns a double-word aligned chunk of memory immediately following the header of the epilogue block. This header becomes the header of the new free block (line 12), and the last word of the chunk becomes the new epilogue block header (line 14). Finally, in the likely case that the previous heap was terminated by a free block, we call the `coalesce` function to merge the two free blocks and return the block pointer of the merged blocks (line 17).




## Freeing and Coalescing Blocks

An application frees a previously allocated block by calling the `mm_free` function (Figure 9.46 [□](#)), which frees the requested block (`bp`) and then merges adjacent free blocks using the boundary-tags coalescing technique described in Section 9.9.11 [□](#).

The code in the coalesce helper function is a straightforward implementation of the four cases outlined in Figure 9.40 [□](#). There is one somewhat subtle aspect. The free list format we have chosen—with its prologue and epilogue blocks that are always marked as allocated—allows us to ignore the potentially troublesome edge conditions where the requested block `bp` is at the beginning or end of the heap. Without these special blocks, the code would be messier, more error prone, and slower because we would have to check for these rare edge conditions on each and every free request.

## *Allocating Blocks*

An application requests a block of size bytes of memory by calling the `mm_malloc` function (Figure 9.47 ). After checking for spurious requests, the allocator must adjust the requested block size to allow room for the header and the footer, and to satisfy the double-word alignment requirement. Lines 12–13 enforce the minimum block size of 16 bytes: 8 bytes to satisfy the alignment requirement and 8 more bytes for the overhead of the header and footer. For requests over 8 bytes (line 15), the general rule is to add in the overhead bytes and then round up to the nearest multiple of 8.

Once the allocator has adjusted the requested size, it searches the free list for a suitable free block (line 18). If there is a fit, then the allocator places the requested block and optionally splits the excess (line 19) and then returns the address of the newly allocated block.

If the allocator cannot find a fit, it extends the heap with a new free block (lines 24–26), places the requested block in the new free block, optionally splitting the block (line 27), and then returns a pointer to the newly allocated block.



```

1 void mm_free(void *bp)
2 {
3     size_t size = GET_SIZE(HDRP(bp));
4
5     PUT(HDRP(bp), PACKCsize, 0);
6     PUT(FTRPCbp, PACKCsize, 0);
7     coalesce(bp);
8 }
9
10 static void *coalesce(void *bp)
11 {
12     size_t prev_alloc = GET_ALLOC(FTRP(PREV_BLKp(bp)));
13     size_t next_alloc = GET_ALLOC(HDRP(NEXT_BLKp(bp)));
14     size_t size = GET_SIZE(HDRP(bp));
15
16     if (prev_alloc && next_alloc) { /* Case 1 */
17         return bp;
18     }
19
20     else if (prev_alloc && !next_alloc) { /* Case 2 */
21         size += GET_SIZE(HDRP(NEXT_BLKp(bp)));
22         PUT(HDRP(bp), PACK(size, 0));
23         PUT (FTRP(bp), PACK(size,0));
24     }
25
26     else if (!prev_alloc && next_alloc) { /* Case 3 */
27         size += GET_SIZE(HDRP(PREV_BLKp(bp)));
28         PUT(FTRPCbp, PACKCsize, 0);
29         PUT(HDRP(PREV_BLKp(bp)), PACKCsize, 0);
30         bp = PREV_BLKp(bp);
31     }
32
33     else { /* Case 4 */
34         size += GET_SIZE(HDRP(PREV_BLKp(bp))) +
35             GET_SIZE(FTRP(NEXT_BLKp(bp)));
36         PUT(HDRP(PREV_BLKp(bp)), PACKCsize, 0);
37         PUT(FTRP(NEXT_BLKp(bp)), PACKCsize, 0);
38         bp = PREV_BLKp(bp);
39     }

```

```
40     return bp;
41 }
```

---

*code/vm/malloc/m*

*m.c*

**Figure 9.46** `mm_free` frees a block and uses boundary-tag coalescing to merge it with any adjacent free blocks in constant time.

mm.c

```
1 void *mm_malloc(size_t size)
2 {
3     size_t asize; /* Adjusted block size */
4     size_t extendsize; /* Amount to extend heap if no fit */
5     char *bp;
6
7     /* Ignore spurious requests */
8     if (size == 0)
9         return NULL;
10
11     /* Adjust block size to include overhead and alignment reqs. */
12     if (size <= DSIZE)
13         asize = 2*DSIZE;
14     else
15         asize = DSIZE * ((size + (DSIZE) + (DSIZE-1)) / DSIZE);
16
17     /* Search the free list for a fit */
18     if ((bp = find_fit(asize)) != NULL) {
19         place(bp, asize);
20         return bp;
21     }
22
23     /* No fit found. Get more memory and place the block */
24     extendsize = MAX(asize, CHUNKSIZE);
25     if ((bp = extend_heap(extendsize/WSIZE)) == NULL)
26         return NULL;
27     place(bp, asize);
28     return bp;
29 }
```

mm.c

**Figure 9.47** `mm_malloc` allocates a block from the free list.

## Practice Problem 9.8 (solution page [884](#))

Implement a `find_fit` function for the simple allocator described in [Section 9.9.12](#).

```
static void *find_fit(size_t asize)
```

Your solution should perform a first-fit search of the implicit free list.

## Practice Problem 9.9 (solution page [884](#))

Implement a `place` function for the example allocator.

```
static void place(void *bp, size_t asize)
```

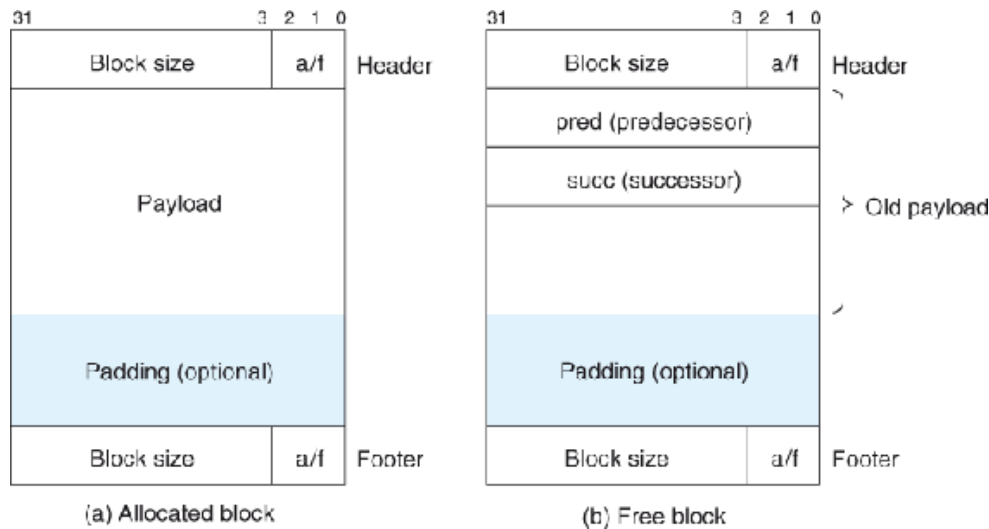
Your solution should place the requested block at the beginning of the free block, splitting only if the size of the remainder would equal or exceed the minimum block size.

## 9.9.13 Explicit Free Lists

The implicit free list provides us with a simple way to introduce some basic allocator concepts. However, because block allocation time is linear in the total number of heap blocks, the implicit free list is not appropriate for a general-purpose allocator (although it might be fine for a special-purpose allocator where the number of heap blocks is known beforehand to be small).

A better approach is to organize the free blocks into some form of explicit data structure. Since by definition the body of a free block is not needed by the program, the pointers that implement the data structure can be stored within the bodies of the free blocks. For example, the heap can be organized as a doubly linked free list by including a `pred` (predecessor) and `succ` (successor) pointer in each free block, as shown in [Figure 9.48](#).

Using a doubly linked list instead of an implicit free list reduces the first-fit allocation time from linear in the total number of blocks to linear in the number of *free* blocks. However, the time to free a block can be either linear or constant, depending on the policy we choose for ordering the blocks in the free list.



**Figure 9.48** Format of heap blocks that use doubly linked free lists.

One approach is to maintain the list in *last-in first-out* (LIFO) order by inserting newly freed blocks at the beginning of the list. With a LIFO ordering and a first-fit placement policy, the allocator inspects the most recently used blocks first. In this case, freeing a block can be performed in constant time. If boundary tags are used, then coalescing can also be performed in constant time.

Another approach is to maintain the list in *address order*, where the address of each block in the list is less than the address of its successor. In this case, freeing a block requires a linear-time search to



locate the appropriate predecessor. The trade-off is that address-ordered first fit enjoys better memory utilization than LIFO-ordered first fit, approaching the utilization of best fit.

A disadvantage of explicit lists in general is that free blocks must be large enough to contain all of the necessary pointers, as well as the header and possibly a footer. This results in a larger minimum block size and increases the potential for internal fragmentation.

## 9.9.14 Segregated Free Lists

As we have seen, an allocator that uses a single linked list of free blocks requires time linear in the number of free blocks to allocate a block. A popular approach for reducing the allocation time, known generally as *segregated storage*, is to maintain multiple free lists, where each list holds blocks that are roughly the same size. The general idea is to partition the set of all possible block sizes into equivalence classes called *size classes*. There are many ways to define the size classes. For example, we might partition the block sizes by powers of 2:

$$\{1\}, \{2\}, \{3, 4\}, \{5 - 8\}, \dots, \{1,025 - 2,048\}, \{2,049 - 4,096\}, \{4,097 - \infty\}$$

Or we might assign small blocks to their own size classes and partition large blocks by powers of 2:

$$\{1\}, \{2\}, \{3\}, \dots, \{1,023\}, \{1,024\}, \{1,025 - 2,048\}, \{2,049 - 4,096\}, \{4,097 - \infty\}$$

The allocator maintains an array of free lists, with one free list per size class, ordered by increasing size. When the allocator needs a block of size  $n$ , it searches the appropriate free list. If it cannot find a block that fits, it searches the next list, and so on.


The dynamic storage allocation literature describes dozens of variants of segregated storage that differ in how they define size classes, when they perform coalescing, when they request additional heap memory from the operating system, whether they allow splitting, and so forth. To give you a sense of what is possible, we will describe two of the basic approaches: *simple segregated storage* and *segregated fits*.

## Simple Segregated Storage

With simple segregated storage, the free list for each size class contains same-size blocks, each the size of the largest element of the size class. For example, if some size class is defined as {17–32}, then the free list for that class consists entirely of blocks of size 32.

To allocate a block of some given size, we check the appropriate free list. If the list is not empty, we simply allocate the first block in its entirety. Free blocks are never split to satisfy allocation requests. If the list is empty, the allocator requests a fixed-size chunk of additional memory from the operating system (typically a multiple of the page size), divides the chunk into equal-size blocks, and links the blocks together to form the new free list. To free a block, the allocator simply inserts the block at the front of the appropriate free list.

There are a number of advantages to this simple scheme. Allocating and freeing blocks are both fast constant-time operations. Further, the combination of the same-size blocks in each chunk, no splitting, and no coalescing means that there is very little per-block memory overhead. Since each chunk has only same-size blocks, the size of an allocated block can be inferred from its address. Since there is no coalescing, allocated blocks do not need an allocated/free flag in the header. Thus, allocated blocks require no headers, and since there is no coalescing, they do not require any footers either. Since allocate and free operations insert and delete blocks at the beginning of the free list, the list need only be singly linked instead of doubly linked. The bottom line is that the only required field in any block is a one-word `succ` pointer in each free block, and thus the minimum block size is only one word.

A significant disadvantage is that simple segregated storage is susceptible to internal and external fragmentation. Internal fragmentation is possible because free blocks are never split. Worse, certain reference patterns can cause extreme external fragmentation because free blocks are never coalesced ([Practice Problem 9.10](#) .

### Practice Problem 9.10 (solution page [885](#))

Describe a reference pattern that results in severe external fragmentation in an allocator based on simple segregated storage.

## *Segregated Fits*

With this approach, the allocator maintains an array of free lists. Each free list is associated with a size class and is organized as some kind of explicit or implicit list. Each list contains potentially different-size blocks whose sizes are members of the size class. There are many variants of segregated fits allocators. Here we describe a simple version.

To allocate a block, we determine the size class of the request and do a first-fit search of the appropriate free list for a block that fits. If we find one, then we (optionally) split it and insert the fragment in the appropriate free list. If we cannot find a block that fits, then we search the free list for the next larger size class. We repeat until we find a block that fits. If none of the free lists yields a block that fits, then we request additional heap memory from the operating system, allocate the block out of this new heap memory, and place the remainder in the appropriate size class. To free a block, we coalesce and place the result on the appropriate free list.

The segregated fits approach is a popular choice with production-quality allocators such as the GNU `malloc` package provided in the C standard library because it is both fast and memory efficient. Search times are reduced because searches are limited to particular parts of the heap instead of the entire heap. Memory utilization can improve because of the interesting fact that a simple first-fit search of a segregated free list approximates a best-fit search of the entire heap.

## Buddy Systems

A *buddy system* is a special case of segregated fits where each size class is a power of 2. The basic idea is that, given a heap of  $2^m$  words, we maintain a separate free list for each block size  $2^k$ , where  $0 \leq k \leq m$ . Requested block sizes are rounded up to the nearest power of 2. Originally, there is one free block of size  $2^m$  words.

To allocate a block of size  $2^k$ , we find the first available block of size  $2^j$ , such that  $k \leq j \leq m$ . If  $j = k$ , then we are done. Otherwise, we recursively split the block in half until  $j = k$ . As we perform this splitting, each remaining half (known as a *buddy*) is placed on the appropriate free list. To free a block of size  $2^k$ , we continue coalescing with the free buddies. When we encounter an allocated buddy, we stop the coalescing.

A key fact about buddy systems is that, given the address and size of a block, it is easy to compute the address of its buddy. For example, a block of size 32 bytes with address

$xxx \dots x00000$

has its buddy at address

$xxx \dots x10000$

In other words, the addresses of a block and its buddy differ in exactly one bit position.

The major advantage of a buddy system allocator is its fast searching and coalescing. The major disadvantage is that the power-of-2 requirement on the block size can cause significant internal fragmentation. For this reason, buddy system allocators are not appropriate for general-purpose workloads. However, for certain application-specific workloads, where the block sizes are known in advance to be powers of 2, buddy system allocators have a certain appeal.

[OceanofPDF.com](http://OceanofPDF.com)

## 9.10 Garbage Collection

With an explicit allocator such as the C `malloc` package, an application allocates and frees heap blocks by making calls to `malloc` and `free`. It is the application's responsibility to free any allocated blocks that it no longer needs.

Failing to free allocated blocks is a common programming error. For example, consider the following C function that allocates a block of temporary storage as part of its processing:


```
1 void garbage()  
2 {  
3     int *p = (int *)Malloc(15213);  
4  
5     return; /* Array p is garbage at this point */  
6 }
```

Since `p` is no longer needed by the program, it should have been freed before `garbage` returned. Unfortunately, the programmer has forgotten to free the block. It remains allocated for the lifetime of the program, needlessly occupying heap space that could be used to satisfy subsequent allocation requests.

A *garbage collector* is a dynamic storage allocator that automatically frees allocated blocks that are no longer needed by the program. Such blocks are known as *garbage* (hence the term "garbage collector"). The process of automatically reclaiming heap storage is known as *garbage collection*. In a system that supports garbage collection, applications explicitly allocate heap blocks but never explicitly free them. In the context of a C program, the application calls `malloc` but never calls `free`. Instead, the garbage collector periodically identifies the garbage blocks and makes the appropriate calls to `free` to place those blocks back on the free list.

Garbage collection dates back to Lisp systems developed by John McCarthy at MIT in the early 1960s. It is an important part of modern language systems such as Java, ML, Perl, and Mathematica, and it remains an active and important area of research. The literature describes an amazing number of approaches for garbage collection. We will limit our discussion to McCarthy's original *Mark&Sweep* algorithm, which is interesting because it can be built on top of an existing `malloc` package to provide garbage collection for C and C++ programs.

## 9.10.1 Garbage Collector Basics

A garbage collector views memory as a directed *reachability graph* of the form shown in [Figure 9.49](#) . The nodes of the graph are partitioned into a set of *root nodes* and a set of *heap nodes*. Each heap node corresponds to an allocated block in the heap. A directed edge  $p \rightarrow q$  means that some location in block  $p$  points to some location in block  $q$ . Root nodes correspond to locations not in the heap that contain pointers into the heap. These locations can be registers, variables on the stack, or global variables in the read/write data area of virtual memory.

We say that a node  $p$  is *reachable* if there exists a directed path from any root node to  $p$ . At any point in time, the unreachable nodes correspond to garbage that can never be used again by the application. The role of a garbage collector is to maintain some representation of the reachability graph and periodically reclaim the unreachable nodes by freeing them and returning them to the free list.



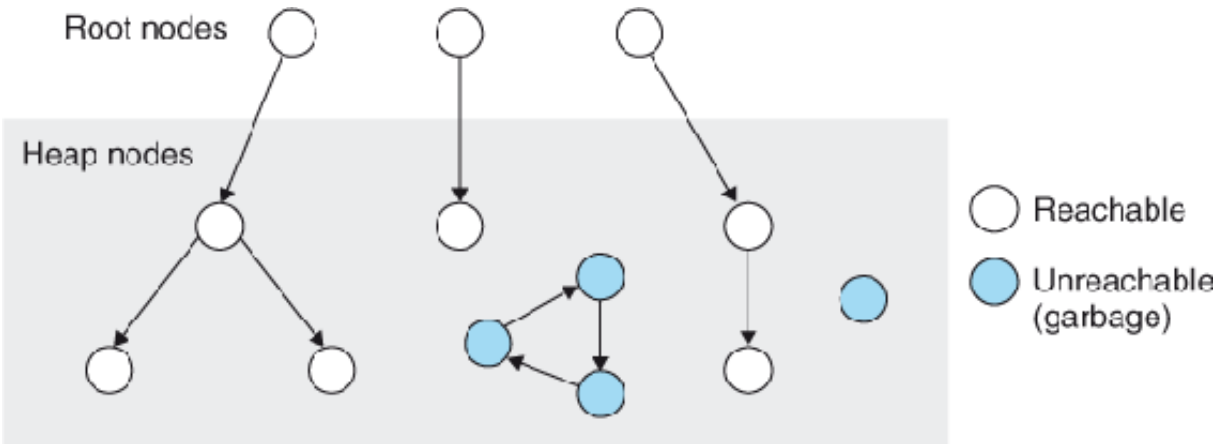


Figure 9.49 A garbage collector's view of memory as a directed graph.

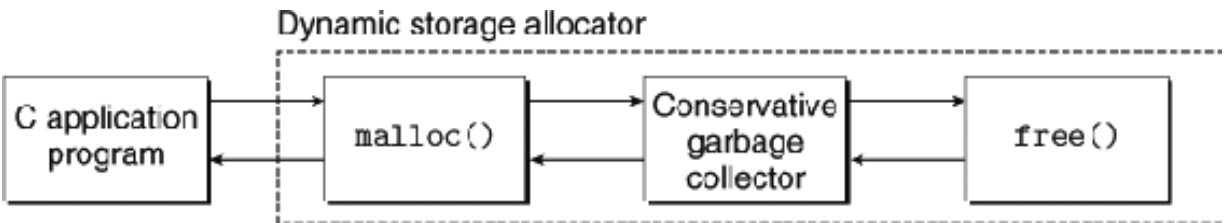



Figure 9.50 Integrating a conservative garbage collector and a C `malloc` package.

Garbage collectors for languages like ML and Java, which exert tight control over how applications create and use pointers, can maintain an exact representation of the reachability graph and thus can reclaim all garbage. However, collectors for languages like C and C++ cannot in general maintain exact representations of the reachability graph. Such collectors are known as *conservative garbage collectors*. They are conservative in the sense that each reachable block is correctly identified as reachable, while some unreachable nodes might be incorrectly identified as reachable.

Collectors can provide their service on demand, or they can run as separate threads in parallel with the application, continuously updating the reachability graph and reclaiming garbage. For example, consider how we might incorporate a conservative collector for C programs into an existing `malloc` package, as shown in **Figure 9.50** .

The application calls `malloc` in the usual manner whenever it needs heap space. If `malloc` is unable to find a free block that fits, then it calls the garbage collector in hopes of reclaiming some garbage to the free list. The collector identifies the garbage blocks and returns them to the heap by calling the `free` function. The key idea is that the collector calls `free` instead of the application. When the call to the collector returns, `malloc` tries again to find a free block that fits. If that fails, then it can ask the operating system for additional memory. Eventually, `malloc` returns a pointer to the requested block (if successful) or the NULL pointer (if unsuccessful).

## 9.10.2 Mark&Sweep Garbage Collectors

A Mark&Sweep garbage collector consists of a *mark phase*, which marks all reachable and allocated descendants of the root nodes, followed by a *sweep phase*, which frees each unmarked allocated block. Typically, one of the spare low-order bits in the block header is used to indicate whether a block is marked or not.

(a) `mark` function

```
|  
void mark (ptr p) {  
    if ((b = isPtr(p)) == NULL)  
        return;  
    if (blockMarked(b))  
        return;  
    markBlock(b);  
    len = length(b);  
    for (i=0; i < len; i++)  
        mark(b[i]);  
    return;  
}
```

(b) `sweep` function

```

|
void sweep(ptr b, ptr end) {
    while (b < end) {
        if (blockMarked(b))
            unmarkBlock(b);
        else if (blockAllocated(b))
            free(b);
        b = nextBlock(b);
    }
    return;
}

```

**Figure 9.51** Pseudocode for the `mark` and `sweep` functions.

Our description of Mark&Sweep will assume the following functions, where `ptr` is defined as `typedef void *ptr`:

`ptr isPtr (ptr p)`. If `p` points to some word in an allocated block, it returns a pointer `b` to the beginning of that block. Returns NULL otherwise.

`int blockMarked(ptr b)`. Returns true if block `b` is already marked.


`int blockAllocated(ptr b)`. Returns true if block `b` is allocated.


`void markBlock(ptr b)`. Marks block `b`.


`int length (ptr b)`. Returns the length in words (excluding the header) of block `b`.

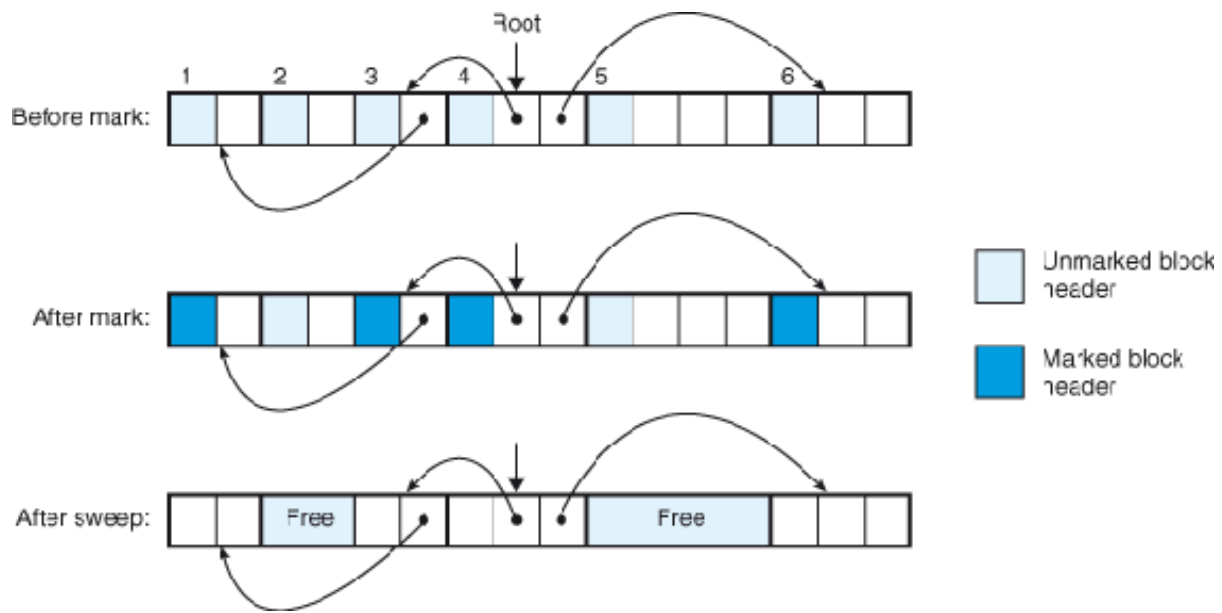
`void unmarkBlock (ptr b)`. Changes the status of block `b` from marked to unmarked.

`ptr nextBlock(ptr b)`. Returns the successor of block `b` in the heap.

The mark phase calls the mark function shown in [Figure 9.51\(a\)](#)  once for each root node. The `mark` function returns immediately if `p` does not point to an allocated and unmarked heap block. Otherwise, it marks the block and calls itself recursively on each word in block. Each call to the `mark` function marks any unmarked and reachable descendants of some root node. At the end of the mark phase, any allocated block that is not marked is guaranteed to be unreachable and, hence, garbage that can be reclaimed in the sweep phase.

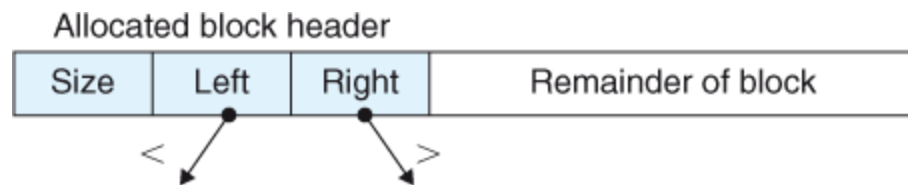
The sweep phase is a single call to the sweep function shown in [Figure 9.51\(b\)](#) . The `sweep` function iterates over each block in the heap, freeing any unmarked allocated blocks (i.e., garbage) that it encounters.

[Figure 9.52](#)  shows a graphical interpretation of Mark&Sweep for a small heap. Block boundaries are indicated by heavy lines. Each square corresponds to a word of memory. Each block has a one-word header, which is either marked or unmarked.



**Figure 9.52 Mark&Sweep example.**

Note that the arrows in this example denote memory references, not free list pointers.



**Figure 9.53 Left and right pointers in a balanced tree of allocated blocks.**

Initially, the heap in [Figure 9.52](#) consists of six allocated blocks, each of which is unmarked. Block 3 contains a pointer to block 1. Block 4 contains pointers to blocks 3 and 6. The root points to block 4. After the mark phase, blocks 1,3,4, and 6 are marked because they are reachable from the root. Blocks 2 and 5 are unmarked because they are unreachable. After the sweep phase, the two unreachable blocks are reclaimed to the free list.

## 9.10.3 Conservative Mark&Sweep for C Programs

Mark&Sweep is an appropriate approach for garbage collecting C programs because it works in place without moving any blocks. However, the C language poses some interesting challenges for the implementation of the `isPtr` function.

First, C does not tag memory locations with any type information. Thus, there is no obvious way for `isPtr` to determine if its input parameter `p` is a pointer or not. Second, even if we were to know that `p` was a pointer, there would be no obvious way for `isPtr` to determine whether `p` points to some location in the payload of an allocated block.

One solution to the latter problem is to maintain the set of allocated blocks as a balanced binary tree that maintains the invariant that all blocks in the left subtree are located at smaller addresses and all blocks in the right subtree are located in larger addresses. As shown in [Figure 9.53](#), this requires two additional fields (`left` and `right`) in the header of each allocated block. Each field points to the header of some allocated block. The `isPtr(ptr p)` function uses the tree to perform a binary search of the allocated blocks. At each step, it relies on the size field in the block header to determine if `p` falls within the extent of the block.



The balanced tree approach is correct in the sense that it is guaranteed to mark all of the nodes that are reachable from the roots. This is a necessary guarantee, as application users would certainly not appreciate having their allocated blocks prematurely returned to the free list. However, it is conservative in the sense that it may incorrectly mark blocks that are actually unreachable, and thus it may fail to free some garbage. While this does not affect the correctness of application programs, it can result in unnecessary external fragmentation.

The fundamental reason that Mark&Sweep collectors for C programs must be conservative is that the C language does not tag memory locations with type information. Thus, scalars like `ints` or `floats` can masquerade as pointers. For example, suppose that some reachable allocated block contains an `int` in its payload whose value happens to correspond to an address in the payload of some other allocated block *b*. There is no way for the collector to infer that the data is really an `int` and not a pointer. Therefore, the allocator must conservatively mark block *b* as reachable, when in fact it might not be.

## 9.11 Common Memory-Related Bugs in C Programs

Managing and using virtual memory can be a difficult and error-prone task for C programmers. Memory-related bugs are among the most frightening because they often manifest themselves at a distance, in both time and space, from the source of the bug. Write the wrong data to the wrong location, and your program can run for hours before it finally fails in some distant part of the program. We conclude our discussion of virtual memory with a look at some of the common memory-related bugs.

# 9.11.1 Dereferencing Bad Pointers

As we learned in [Section 9.7.2](#), there are large holes in the virtual address space of a process that are not mapped to any meaningful data. If we attempt to dereference a pointer into one of these holes, the operating system will terminate our program with a segmentation exception. Also, some areas of virtual memory are read-only. Attempting to write to one of these areas terminates the program with a protection exception.

A common example of dereferencing a bad pointer is the classic `scanf` bug. Suppose we want to use `scanf` to read an integer from `stdin` into a variable. The correct way to do this is to pass `scanf` a format string and the *address* of the variable:

```
scanf ("%d", &val)
```

However, it is easy for new C programmers (and experienced ones too!) to pass the *contents* of `val` instead of its address:

```
|  
scanf ("%d", val)
```

In this case, `scanf` will interpret the contents of `val` as an address and attempt to write a word to that location. In the best case, the program terminates immediately with an exception. In the worst case, the contents of `val` correspond to some valid read/write area of virtual memory, and we overwrite memory, usually with disastrous and baffling consequences much later.

## 9.11.2 Reading Uninitialized Memory

While bss memory locations (such as uninitialized global C variables) are always initialized to zeros by the loader, this is not true for heap memory. A common error is to assume that heap memory is initialized to zero:

```
1      /* Return y = Ax */
2      int *matvec(int **A, int *x, int n)
3      {
4          int i, j;
5
6          int *y = (int *)Malloc(n * sizeof(int));
7
8          for (i = 0; i < n; i++)
9              for (j = 0; j < n; j++)
10                 y[i] += A[i][j] * x[j];
11          return y;
12     }
```

In this example, the programmer has incorrectly assumed that vector `y` has been initialized to zero. A correct implementation would explicitly zero `y[i]` or use `calloc`.

## 9.11.3 Allowing Stack Buffer Overflows

As we saw in [Section 3.10.3](#), a program has a *buffer overflow bug* if it writes to a target buffer on the stack without examining the size of the input string. For example, the following function has a buffer overflow bug because the `gets` function copies an arbitrary-length string to the buffer. To fix this, we would need to use the `fgets` function, which limits the size of the input string.

```
|  
1 void bufoverflow()  
2 {  
3     char buf [64];  
4  
5     gets(buf); /* Here is the stack buffer overflow  
bug */  
6     return;  
7 }
```

## 9.11.4 Assuming That Pointers and the Objects They Point to Are the Same Size

One common mistake is to assume that pointers to objects are the same size as the objects they point to:

```
1      /* Create an nxm array */
2      int **makeArray1(int n, int m)
3      {
4          int i;
5          int **A = (int **)Malloc(n * sizeof(int));
6
7          for (i = 0; i < n; i++)
8              A[i] = (int *)Malloc(m * sizeof(int));
9          return A;
10     }
```

The intent here is to create an array of  $n$  pointers, each of which points to an array of  $m$  `ints`. However, because the programmer has written `sizeof (int)` instead of `sizeof (int *)` in line 5, the code actually creates an array of `ints`.

This code will run fine on machines where `ints` and pointers to `ints` are the same size. But if we run this code on a machine like the Core i7, where a pointer is larger than an `int`, then the loop in lines 7–8 will write past the end of the A array. Since one of these words will likely be the boundary-tag footer of the allocated block, we may not discover the error until we free the block much later in the program, at which point the coalescing code in the allocator will fail dramatically and for no apparent reason. This is an insidious example of the kind of "action at a distance" that is so typical of memory-related programming bugs.



## 9.11.5 Making Off-by-One Errors

Off-by-one errors are another common source of overwriting bugs:

```
1      /* Create an nxm array */
2      int **makeArray2(int n, int m)
3      {
4          int i;
5          int **A = (int **)Malloc(n * sizeof(int *));
6
7          for (i = 0; i <= n; i++)
8              A[i] = (int *)Malloc(m * sizeof(int));
9          return A;
10     }
```

This is another version of the program in the previous section. Here we have created an  $n$ -element array of pointers in line 5 but then tried to initialize  $n + 1$  of its elements in lines 7 and 8, in the process overwriting some memory that follows the A array.

## 9.11.6 Referencing a Pointer Instead of the Object It Points To

If we are not careful about the precedence and associativity of C operators, then we incorrectly manipulate a pointer instead of the object it points to. For example, consider the following function, whose purpose is to remove the first item in a binary heap of `*size` items and then reheapify the remaining `*size - 1` items:

```
1     int *binheapDelete(int **binheap, int *size)
2     {
3         int *packet = binheap[0];
4
5         binheap [0] = binheap [*size - 1];
6         *size--; /* This should be (*size)-- */
7         heapify(binheap, *size, 0);
8         return(packet);
9     }
```

In line 6, the intent is to decrement the integer value pointed to by the size pointer. However, because the unary `--` and `*` operators have the same precedence and associate from right to left, the code in line 6 actually decrements the pointer itself instead of the integer value that it points to. If we are lucky, the program will crash

immediately. But more likely we will be left scratching our heads when the program produces an incorrect answer much later in its execution. The moral here is to use parentheses whenever in doubt about precedence and associativity. For example, in line 6, we should have clearly stated our intent by using the expression `(*size)--`.

## 9.11.7 Misunderstanding Pointer Arithmetic

Another common mistake is to forget that arithmetic operations on pointers are performed in units that are the size of the objects they point to, which are not necessarily bytes. For example, the intent of the following function is to scan an array of `ints` and return a pointer to the first occurrence of `val`:

```
1 int *search(int *p, int val)
2 {
3     while (*p && *p != val)
4         p += sizeof(int); /* Should be p++ */
5     return p;
6 }
```

However, because line 4 increments the pointer by 4 (the number of bytes in an integer) each time through the loop, the function incorrectly scans every fourth integer in the array.

## 9.11.8 Referencing Nonexistent Variables

Naive C programmers who do not understand the stack discipline will sometimes reference local variables that are no longer valid, as in the following example:

```
1 int *stackref ()
2 {
3     int val;
4
5     return &val;
6 }
```

This function returns a pointer (say, `p`) to a local variable on the stack and then pops its stack frame. Although `p` still points to a valid memory address, it no longer points to a valid variable. When other functions are called later in the program, the memory will be reused for their stack frames. Later, if the program assigns some value to `*p`, then it might actually be modifying an entry in another function's stack frame, with potentially disastrous and baffling consequences.

## 9.11.9 Referencing Data in Free Heap Blocks

A similar error is to reference data in heap blocks that have already been freed. Consider the following example, which allocates an integer array `x` in line 6, prematurely frees block `x` in line 10, and then later references it in line 14:

```

1     int *heapref(int n, int m)
2     {
3         int i;
4         int *x, *y;
5
6         x = (int *)Malloc(n * sizeof(int));
7
8         : // Other calls to malloc and free go here
9
10        free(x);
11
12        y = (int *)Malloc(m * sizeof(int));
13        for (i = 0; i < m; i++)
14            y[i] = x[i]++; /* Oops! x[i] is a word
in a free block */
15
16        return y;
17    }

```

Depending on the pattern of `malloc` and `free` calls that occur between lines 6 and 10, when the program references `x[i]` in line 14, the array `x` might be part of some other allocated heap block and may have been overwritten. As with many memory-related bugs, the error will only become evident later in the program when we notice that the values in `y` are corrupted.

## 9.11.10 Introducing Memory Leaks

Memory leaks are slow, silent killers that occur when programmers inadvertently create garbage in the heap by forgetting to free allocated blocks. For example, the following function allocates a heap block `x` and then returns without freeing it:

```
1 void leak(int n)
2 {
3     int *x = (int *)Malloc(n * sizeof(int));
4
5     return; /* x is garbage at this point */
6 }
```

If `leak` is called frequently, then the heap will gradually fill up with garbage, in the worst case consuming the entire virtual address space. Memory leaks are particularly serious for programs such as daemons and servers, which by definition never terminate.



## 9.12 Summary

Virtual memory is an abstraction of main memory. Processors that support virtual memory reference main memory using a form of indirection known as virtual addressing. The processor generates a virtual address, which is translated into a physical address before being sent to the main memory. The translation of addresses from a virtual address space to a physical address space requires close cooperation between hardware and software. Dedicated hardware translates virtual addresses using page tables whose contents are supplied by the operating system.

Virtual memory provides three important capabilities. First, it automatically caches recently used contents of the virtual address space stored on disk in main memory. The block in a virtual memory cache is known as a page. A reference to a page on disk triggers a page fault that transfers control to a fault handler in the operating system. The fault handler copies the page from disk to the main memory cache, writing back the evicted page if necessary. Second, virtual memory simplifies memory management, which in turn simplifies linking, sharing data between processes, the allocation of memory for processes, and program loading. Finally, virtual memory simplifies memory protection by incorporating protection bits into every page table entry.

The process of address translation must be integrated with the operation of any hardware caches in the system. Most page table entries are located in the L1 cache, but the cost of accessing page table entries from L1 is usually eliminated by an on-chip cache of page table entries called a TLB.

Modern systems initialize chunks of virtual memory by associating them with chunks of files on disk, a process known as memory mapping. Memory mapping provides an efficient mechanism for sharing data, creating new processes, and loading programs. Applications can manually create and delete areas of the virtual address space using the `mmap` function. However, most programs rely on a dynamic memory allocator such as `malloc`, which manages memory in an area of the virtual address space called the heap. Dynamic memory allocators are application-level programs with a system-level feel, directly manipulating memory without much help from the type system. Allocators come in two flavors. Explicit allocators require applications to explicitly free their memory blocks. Implicit allocators (garbage collectors) free any unused and unreachable blocks automatically.

Managing and using memory is a difficult and error-prone task for C programmers. Examples of common errors include dereferencing bad pointers, reading uninitialized memory, allowing stack buffer overflows, assuming that pointers and the objects they point to are the same size, referencing a pointer instead of the object it points to, misunderstanding pointer arithmetic, referencing nonexistent variables, and introducing memory leaks.

[OceanofPDF.com](http://OceanofPDF.com)

# Bibliographic Notes

Kilburn and his colleagues published the first description of virtual memory [63]. Architecture texts contain additional details about the hardware's role in virtual memory [46]. Operating systems texts contain additional information about the operating system's role [102,106,113]. Bovet and Cesati [11] give a detailed description of the Linux virtual memory system. Intel Corporation provides detailed documentation on 32-bit and 64-bit address translation on IA processors [52].

Knuth wrote the classic work on storage allocation in 1968 [64]. Since that time, there has been a tremendous amount of work in the area. Wilson, Johnstone, Neely, and Boles have written a beautiful survey and performance evaluation of explicit allocators [118]. The general comments in this book about the throughput and utilization of different allocator strategies are paraphrased from their survey. Jones and Lins provide a comprehensive survey of garbage collection [56]. Kernighan and Ritchie [61] show the complete code for a simple allocator based on an explicit free list with a block size and successor pointer in each free block. The code is interesting in that it uses unions to eliminate a lot of the complicated pointer arithmetic, but at the expense of a linear-time (rather than constant-time) free operation. Doug Lea developed a widely used open-source malloc package called `dldmalloc` [67].

[OceanofPDF.com](http://OceanofPDF.com)

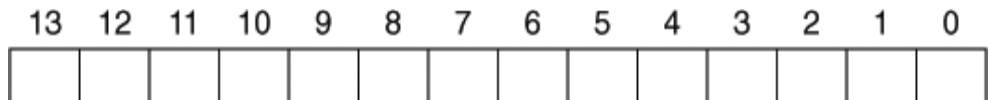
# Homework Problems

# 9.11

In the following series of problems, you are to show how the example memory system in [Section 9.6.4](#) translates a virtual address into a physical address and accesses the cache. For the given virtual address, indicate the TLB entry accessed, the physical address, and the cache byte value returned. Indicate whether the TLB misses, whether a page fault occurs, and whether a cache miss occurs. If there is a cache miss, enter "—" for "Cache byte returned." If there is a page fault, enter "—" for "PPN" and leave parts C and D blank.

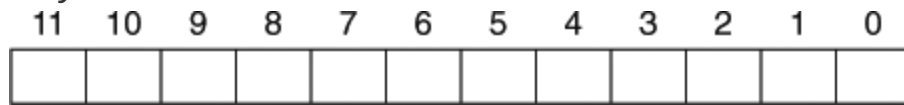
Virtual address: `0x027c`

A. Virtual address format



B. Address translation

C. Physical address format



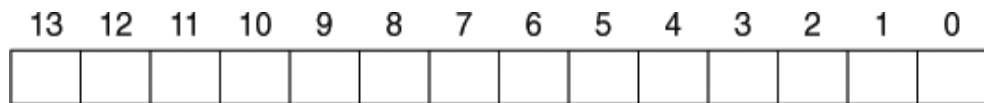
D. Physical memory reference

## 9.12

Repeat [Problem 9.11](#) for the following address.

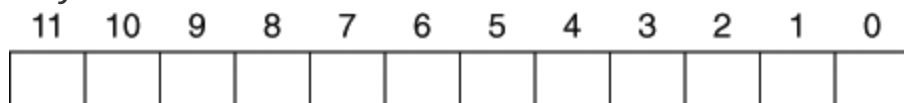
Virtual address: `0x03a9`

A. Virtual address format



B. Address translation

C. Physical address format



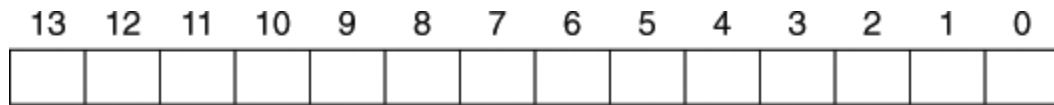
D. Physical memory reference



# 9.13

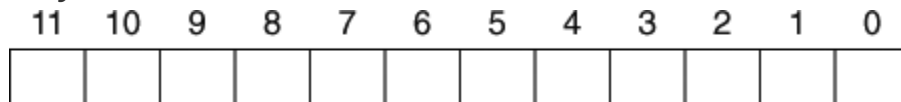
Repeat [Problem 9.11](#) for the following address.

Virtual address: `0x0040`



A. Address translation

B. Physical address format




C. Physical memory reference

# 9.14

Given an input file `hello.txt` that consists of the string `Hello, world!\n`, write a C program that uses `mmap` to change the contents of `hello.txt` to `Jello, world!\n`.

## 9.15

Determine the block sizes and header values that would result from the following sequence of `malloc` requests. Assumptions:

(1) The allocator maintains double-word alignment and uses an implicit free list with the block format from [Figure 9.35](#) .

(2) Block sizes are rounded up to the nearest multiple of 8 bytes.

## 9.16

Determine the minimum block size for each of the following combinations of alignment requirements and block formats.

Assumptions: Explicit free list, 4-byte `pred` and `succ` pointers in each free block, zero-size payloads are not allowed, and headers and footers are stored in 4-byte words.

## 9.17

Develop a version of the allocator in [Section 9.9.12](#) that performs a next-fit search instead of a first-fit search.

## 9.18

The allocator in [Section 9.9.12](#) requires both a header and a footer for each block in order to perform constant-time coalescing. Modify the allocator so that free blocks require a header and a footer, but allocated blocks require only a header.

## 9.19

You are given three groups of statements relating to memory management and garbage collection below. In each group, only one statement is true. Your task is to indicate which statement is true.

1.
  - a. In a buddy system, up to 50% of the space can be wasted due to internal fragmentation.
  - b. The first-fit memory allocation algorithm is slower than the best-fit algorithm (on average).
  - c. Deallocation using boundary tags is fast only when the list of free blocks is ordered according to increasing memory addresses.
  - d. The buddy system suffers from internal fragmentation, but not from external fragmentation.
  
2.
  - a. Using the first-fit algorithm on a free list that is ordered according to decreasing block sizes results in low performance for allocations, but avoids external fragmentation.
  - b. For the best-fit method, the list of free blocks should be ordered according to increasing memory addresses.
  - c. The best-fit method chooses the largest free block into which the requested segment fits.

- d. Using the first-fit algorithm on a free list that is ordered according to increasing block sizes is equivalent to using the best-fit algorithm.
3. Mark&Sweep garbage collectors are called conservative if
- a. They coalesce freed memory only when a memory request cannot be satisfied.
  - b. They treat everything that looks like a pointer as a pointer.
  - c. They perform garbage collection only when they run out of memory.
  - d. They do not free memory blocks forming a cyclic list.

## 9.20

Write your own version of `malloc` and `free`, and compare its running time and space utilization to the version of `malloc` provided in the standard C library.

# Solutions to Practice Problems

## Solution to Problem 9.1 (page 805)

This problem gives you some appreciation for the sizes of different address spaces. At one point in time, a 32-bit address space seemed impossibly large. But now there are database and scientific applications that need more, and you can expect this trend to continue. At some point in your lifetime, expect to find yourself complaining about the cramped 64-bit address space on your personal computer!

## Solution to Problem 9.2 (page 807)

Since each virtual page is  $P = 2^p$  bytes, there are a total of  $2^n/2^p = 2^{n-p}$  possible pages in the system, each of which needs a page table entry (PTE).

## Solution to Problem 9.3 (page 816)

You need to understand this kind of problem well in order to fully grasp address translation. Here is how to solve the first subproblem: We are given  $n = 32$  virtual address bits and  $m = 24$  physical address bits. A page size of  $P = 1$  KB means we need  $\log_2(1 \text{ K}) = 10$  bits for both the VPO and PPO. (Recall that the VPO and PPO are identical.) The remaining address bits are the VPN and PPN, respectively.

# Solution to Problem 9.4 (page 824)

Doing a few of these manual simulations is a great way to firm up your understanding of address translation. You might find it helpful to write out all the bits in the addresses and then draw boxes around the different bit fields, such as VPN, TLBI, and so on. In this particular problem, there are no misses of any kind: the TLB has a copy of the PTE and the cache has a copy of the requested data words. See [Problems 9.11](#), [9.12](#), and [9.13](#) for some different combinations of hits and misses.

A. `00 0011 1101 011i`

C. `0011 0101 011i`

B.

D.



# Solution to Problem 9.5 (page 839)

Solving this problem will give you a good feel for the idea of memory mapping. Try it yourself. We haven't discussed the `open`, `fstat`, or `write` functions, so you'll need to read their man pages to see how they work.

---

code/vm/mmapcopy.c

```

|
1  #include "csapp.h"
2
3  /*
4      * mmapcopy - uses mmap to copy file fd to
stdout
5      */
6  void mmapcopy(int fd, int size)
7  {
8      char *bufp; /* ptr to memory-mapped
VM area */
9
10     bufp = MmapCNULl, size, PROT_READ,
MAP_PRIVATE, fd, 0);
11     Write(1, bufp, size);
12     return;
13 }
14
15 /* mmapcopy driver */
16 int main(int argc, char **argv)
17 {
18     struct stat stat;
19     int fd;
20
21     /* Check for required command-line argument
*/
22     if (argc != 2) {
23         printf("usage : %s <filename>\n",

```

```
argv[0]);  
24         exit(0);  
25     }  
26  
27     /* Copy the input argument to stdout */  
28     fd = Open(argv[1], O_RDONLY, 0);  
29     fstat(fd, festat);  
30     mmapcopy(fd, stat.st_size);  
31     exit(0);  
32 }
```

---

`code/vm/mmapcopy.c`

## Solution to Problem 9.6 (page 849)

This problem touches on some core ideas such as alignment requirements, minimum block sizes, and header encodings. The general approach for determining the block size is to round the sum of the requested payload and the header size to the nearest multiple of the alignment requirement (in this case, 8 bytes). For example, the block size for the `malloc (1)` request is  $4 + 1 = 5$  rounded up to 8. The block size for the `malloc (13)` request is  $13 + 4 = 17$  rounded up to 24.

## Solution to Problem 9.7 (page 852)

The minimum block size can have a significant effect on internal fragmentation. Thus, it is good to understand the minimum block sizes associated with different allocator designs and alignment requirements. The tricky part is to realize that the same block can be allocated or free at different points in time. Thus, the minimum block size is the maximum of the minimum allocated block size and the minimum free block size. For example, in the last subproblem, the minimum allocated block size is a 4-byte header and a 1-byte payload rounded up to 8 bytes. The minimum free block size is a 4-byte header and 4-byte footer, which is already a multiple of 8 and doesn't need to be rounded. So the minimum block size for this allocator is 8 bytes.

# Solution to Problem 9.8 (page 861)

There is nothing very tricky here. But the solution requires you to understand how the rest of our simple implicit-list allocator works and how to manipulate and traverse blocks.

---

*code/vm/malloc/mm.c*

---

```
|
1     static void *find_fit(size_t asize)
2     {
3         /* First-fit search */
4         void *bp;
5
6         for (bp = heap_listp; GET_SIZE(HDRP(bp)) > 0;
bp = NEXT_BLK(P(bp))) {
7             if (!GET_ALLOC(HDRP(bp)) && (asize <=
GET_SIZE(HDRP(bp)))) {
8                 return bp;
9             }
10        }
11        return NULL; /* No fit */
12    #endif
13    }
```

---

*code/vm/malloc/mm.c*

---

## Solution to Problem 9.9 (page 861)

This is another warm-up exercise to help you become familiar with allocators. Notice that for this allocator the minimum block size is 16 bytes. If the remainder of the block after splitting would be greater than or equal to the minimum block size, then we go ahead and split the block (lines 6–10). The only tricky part here is to realize that you need to place the new allocated block (lines 6 and 7) before moving to the next block (line 8).

---

code/vm/malloc/mm.c

```
|
1     static void place(void *bp, size_t asize)
2     {
3         size_t csize = GET_SIZE(HDRP(bp));
4
5         if ((csize - asize) >= (2*DSIZE)) {
6             PUT(HDRP(bp), PACK(asize, 1));
7             PUT(FTRP(bp), PACK(asize, 1));
8             bp = NEXT_BLKP(bp);
9             PUT(HDRP(bp), PACK(csize-asize, 0));
10            PUT(FTRP(bp), PACK(csize-asize, 0));
11        }
12        else {
13            PUT(HDRP(bp), PACK(csize, 1));
14            PUT(FTRP(bp), PACK(csize, 1));
15        }
16    }
```

---

*code/vm/malloc/mm.c*

---



# Solution to Problem 9.10 (page 864)

Here is one pattern that will cause external fragmentation: The application makes numerous allocation and free requests to the first size class, followed by numerous allocation and free requests to the second size class, followed by numerous allocation and free requests to the third size class, and so on. For each size class, the allocator creates a lot of memory that is never reclaimed because the allocator doesn't coalesce, and because the application never requests blocks from that size class again.

[OceanofPDF.com](http://OceanofPDF.com)

# Part III Interaction and Communication between Programs

To this point in our study of computer systems, we have assumed that programs run in isolation, with minimal input and output. However, in the real world, application programs use services provided by the operating system to communicate with I/O devices and with other programs.

This part of the book will give you an understanding of the basic I/O services provided by Unix operating systems and how to use these services to build applications such as Web clients and servers that communicate with each other over the Internet. You will learn techniques for writing concurrent programs, such as Web servers that can service multiple clients at the same time. Writing concurrent application programs can also allow them to execute faster on modern multi-core processors. When you finish this part, you will be well on your way to becoming a power programmer with a mature understanding of computer systems and their impact] on your programs.



# Chapter **10** System-Level I/O



**10.1 Unix I/O 890** 

**10.2 Files 891** 

**10.3 Opening and Closing Files 893** 

**10.4 Reading and Writing Files 895** 

**10.5 Robust Reading and Writing with the Rio Package 897** 

**10.6 Reading File Metadata 903** 

**10.7 Reading Directory Contents 905** 

**10.8 Sharing Files 906** 

**10.9 I/O Redirection 909** 

**10.10 Standard I/O 911** 

**10.11 Putting It Together: Which I/O Functions Should I Use?  
911** 

**10.12 Summary 913** 

**Bibliographic Notes 914** 

**Homework Problems 914** 

**Solutions to Practice Problems 915** 

*Input/output (I/O) is the process of copying data between main memory and external devices such as disk drives, terminals, and networks. An input operation copies data from an I/O device to main memory, and an output operation copies data from memory to a device.*

*All language run-time systems provide higher-level facilities for performing I/O. For example, ANSIC provides the standard I/O library, with functions such as `printf` and `scanf` that perform buffered I/O. The C++ language provides similar functionality with its overloaded `<<` ("put to") and `>>` ("get from") operators. On Linux systems, these higher-level I/O functions are implemented using system-level Unix I/O functions provided by the kernel. Most of the time, the higher-level I/O functions work quite well and there is no need to use Unix I/O directly. So why bother learning about Unix I/O?*

- ***Understanding Unix I/O will help you understand other systems concepts. I/O is integral to the operation of a system, and because of this, we often encounter circular dependencies between I/O and other systems ideas. For example, I/O plays a key***

role in process creation and execution. Conversely, process creation plays a key role in how files are shared by different processes. Thus, to really understand I/O, you need to understand processes, and vice versa. We have already touched on aspects of I/O in our discussions of the memory hierarchy, linking and loading, processes, and virtual memory. Now that you have a better understanding of these ideas, we can close the circle and delve into I/O in more detail.

- **Sometimes you have no choice but to use Unix I/O.** There are some important cases where using higher-level I/O functions is either impossible or inappropriate. For example, the standard I/O library provides no way to access file metadata such as file size or file creation time. Further, there are problems with the standard I/O library that make it risky to use for network programming.

This chapter introduces you to the general concepts of Unix I/O and standard I/O and shows you how to use them reliably from your C programs. Besides serving as a general introduction, this chapter lays a firm foundation

*for our subsequent study of network programming and concurrency.*

[OceanofPDF.com](http://OceanofPDF.com)

## 10.1 Unix I/O

A Linux *file* is a sequence of  $m$  bytes:

$$B_0, B_1, \dots, B_k, \dots, B_{m-1}$$

All I/O devices, such as networks, disks, and terminals, are modeled as files, and all input and output is performed by reading and writing the appropriate files. This elegant mapping of devices to files allows the Linux kernel to export a simple, low-level application interface, known as *Unix I/O*, that enables all input and output to be performed in a uniform and consistent way:

**Opening files.** An application announces its intention to access an I/O device by asking the kernel to *open* the corresponding file. The kernel returns a small nonnegative integer, called a *descriptor*, that identifies the file in all subsequent operations on the file. The kernel keeps track of all information about the open file. The application only keeps track of the descriptor.

Each process created by a Linux shell begins life with three open files: *standard input* (descriptor 0), *standard output* (descriptor 1), and *standard error* (descriptor 2). The header file `<unistd.h>` defines constants `STDIN_FILENO`, `STDOUT_FILENO`, and `STDERR_FILENO`, which can be used instead of the explicit descriptor values.



**Changing the current file position.** The kernel maintains a *file position*  $k$ , initially 0, for each open file. The file position is a byte offset from the beginning of a file. An application can set the current file position  $k$  explicitly by performing a *seek* operation.

**Reading and writing files.** A *read* operation copies  $n > 0$  bytes from a file to memory, starting at the current file position  $k$  and then incrementing  $k$  by  $n$ . Given a file with a size of  $m$  bytes, performing a read operation when  $k \geq m$  triggers a condition known as *end-of-file (EOF)*, which can be detected by the application. There is no explicit "EOF character" at the end of a file.

Similarly, a *write* operation copies  $n > 0$  bytes from memory to a file, starting at the current file position  $k$  and then updating  $k$ .

**Closing files.** When an application has finished accessing a file, it informs the kernel by asking it to *close* the file. The kernel responds by freeing the data structures it created when the file was opened and restoring the descriptor to a pool of available descriptors. When a process terminates for any reason, the kernel closes all open files and frees their memory resources.

## 10.2 Files

Each Linux file has a *type* that indicates its role in the system:

- A *regular file* contains arbitrary data. Application programs often distinguish between *text files*, which are regular files that contain only ASCII or Unicode characters, and *binary files*, which are everything else. To the kernel there is no difference between text and binary files.

A Linux text file consists of a sequence of *text lines*, where each line is a sequence of characters terminated by a *newline* character (`\n`). The newline character is the same as the ASCII line feed character (LF) and has a numeric value of `0x0a`.


- A *directory* is a file consisting of an array of *links*, where each link maps a *filename* to a file, which may be another directory. Each directory contains at

## Aside End of line (EOL) indicators

One of the clumsy aspects of working with text files is that different systems use different characters to mark the end of a line. Linux and Mac OS X use `\n` (`0xa`), which is the ASCII line feed (LF) character. However, MS Windows and Internet protocols such as HTTP use the sequence `\r\n` (`0xd 0xa`), which is the ASCII carriage return (CR) character followed by a line feed (LF). If you create a file `foo.txt` in Windows and then view it in a Linux text editor, you'll see an annoying `␣` at the end of each line, which is how Linux tools display the CR character. You can remove these unwanted CR characters from `foo.txt` in place by running the following command:

```
linux> perl -pi -e "s/\r\n/\n/g" foo.txt
```

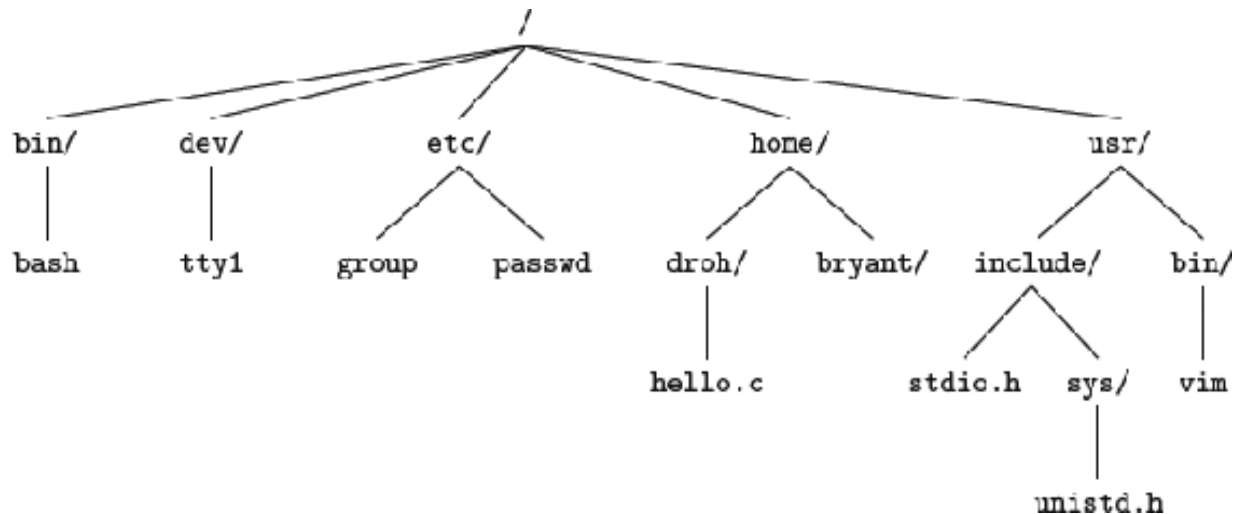
least two entries: `.` (dot) is a link to the directory itself, and `..` (dot-dot) is a link to the *parent directory* in the directory hierarchy (see below). You can create a directory with the `mkdir` command, view its contents with `ls`, and delete it with `rmdir`.

- A *socket* is a file that is used to communicate with another process across a network ([Section 11.4](#) .

Other file types include *named pipes*, *symbolic links*, and *character* and *block devices*, which are beyond our scope.

The Linux kernel organizes all files in a single *directory hierarchy* anchored by the *root directory* named / (slash). Each file in the system is a direct or indirect descendant of the root directory. **Figure 10.1** shows a portion of the directory hierarchy on our Linux system.



As part of its context, each process has a *current working directory* that identifies its current location in the directory hierarchy. You can change the shell's current working directory with the `cd` command.



**Figure 10.1** Portion of the Linux directory hierarchy.

A trailing slash denotes a directory.

Locations in the directory hierarchy are specified by *pathnames*. A pathname is a string consisting of an optional slash followed by a sequence of filenames separated by slashes. Pathnames have two forms:

- An *absolute pathname* starts with a slash and denotes a path from the root node. For example, in **Figure 10.1** , the absolute pathname for `hello.c` is `/home/droh/hello.c`.
- A *relative pathname* starts with a filename and denotes a path from the current working directory. For example, in **Figure 10.1** , if `/home/droh` is the current working directory, then the relative pathname for `hello.c` is `./hello.c`. On the other hand, if `/home/bryant` is the current working directory, then the relative pathname is `../home/droh/hello.c`.

[OceanofPDF.com](http://OceanofPDF.com)

## 10.3 Opening and Closing Files

A process opens an existing file or creates a new file by calling the `open` function.

```
|
#include <sys/types.h>
#include <sys/stat.h>
#include <fcntl.h>
int open(char *filename, int flags, mode_t mode);
Returns: new file descriptor if
OK, -1 on error
```

The `open` function converts a `filename` to a file descriptor and returns the descriptor number. The descriptor returned is always the smallest descriptor that is not currently open in the process. The `flags` argument indicates how the process intends to access the file:

- `O_RDONLY`. Reading only
- `O_WRONLY`. Writing only
- `O_RDWR`. Reading and writing

For example, here is how to open an existing file for reading:

```
fd = Open("foo.txt", O_RDONLY, 0);
```

The `flags` argument can also be `OR`ed with one or more bit masks that provide additional instructions for writing:

`O_CREAT`. If the file doesn't exist, then create a *truncated* (empty) version of it.

`O_TRUNC`. If the file already exists, then truncate it.

`O_APPEND`. Before each write operation, set the file position to the end of the file.

## Figure 10.2 Access permission bits.

Defined in `sys/stat.h`.

For example, here is how you might open an existing file with the intent of appending some data:

```
fd = Open("foo.txt", O_WRONLY|O_APPEND, 0);
```

The `mode` argument specifies the access permission bits of new files. The symbolic names for these bits are shown in [Figure 10.2](#).

As part of its context, each process has a `umask` that is set by calling the `umask` function. When a process creates a new file by calling the `open` function with some `mode` argument, then the access permission bits of the file are set to `mode & ~umask`. For example, suppose we are given the following default values for `mode` and `umask`:

```
#define DEF_MODE S_IRUSR|S_IWUSR|S_IRGRP|S_IWGRP|S_IROTH|S_IWOTH  
#define DEF_UMASK S_IWGRP|S_IWOTH
```

Then the following code fragment creates a new file in which the owner of the file has read and write permissions, and all other users have read permissions:



```
|  
umask(DEF_UMASK);  
fd = Open("foo.txt", O_CREAT|O_TRUNC|O_WRONLY, DEF_MODE);
```

Finally, a process closes an open file by calling the `close` function.

```
|  
#include <unistd.h>  
int close(int fd);  
Returns:  
0 if OK, -1 on error
```

Closing a descriptor that is already closed is an error.

# Practice Problem 10.1 (solution page 915)

What is the output of the following program?


```
|
1  #include "csapp.h"
2
3  int main()
4  {
5      int fd1, fd2;
6
7      fd1 = Open("foo.txt", O_RDONLY, 0);
8      Close(fd1);
9      fd2 = Open("baz.txt", O_RDONLY, 0);
10     printf("fd2 = %d\n", fd2);
11     exit(0);
12 }
```

## 10.4 Reading and Writing Files

Applications perform input and output by calling the `read` and `write` functions, respectively.

```
|
#include <unistd.h>
ssize_t read(int fd, void *buf, size_t n);
Returns: number of bytes
read if OK, 0 on EOF, -1 on error
ssize_t write(int fd, const void *buf, size_t n);
Returns: number of bytes
written if OK, -1 on error
```

The `read` function copies at most `n` bytes from the current file position of descriptor `fd` to memory location `buf`. A return value of `-1` indicates an error, and a return value of `0` indicates EOF. Otherwise, the return value indicates the number of bytes that were actually transferred.

The `write` function copies at most `n` bytes from memory location `buf` to the current file position of descriptor `fd`. [Figure 10.3](#)  shows a program that uses `read` and `write` calls to copy the standard input to the standard output, 1 byte at a time.

Applications can explicitly modify the current file position by calling the `lseek` function, which is beyond our scope.

In some situations, `read` and `write` transfer fewer bytes than the application requests. Such *short counts* do *not* indicate an error. They occur for a number of reasons:

## Aside What's the difference between `ssize_t` and `size_t`?

You might have noticed that the `read` function has a `size_t` input argument and an `ssize_t` return value. So what's the difference between these two types? On x86-64 systems, a `size_t` is defined as an `unsigned long`, and an `ssize_t` (*signed size*) is defined as a `long`. The `read` function returns a signed size rather than an unsigned size because it must return a `-1` on error. Interestingly, the possibility of returning a single `-1` reduces the maximum size of a `read` by a factor of 2.

```

1  #include "csapp.h"
2
3  int main(void)
4  {
5      char c;
6
7      while(Read(STDIN_FILENO, &c, 1) != 0)
8          Write(STDOUT_FILENO, &c, 1);
9      exit(0);
10 }

```

**Figure 10.3** Using `read` and `write` to copy standard input to standard output 1 byte at a time.

**Encountering EOF on reads.** Suppose that we are ready to read from a file that contains only 20 more bytes from the current file position and that we are reading the file in 50-byte chunks. Then the next read will return a short count of 20, and the `read` after that will signal EOF by returning a short count of 0.

**Reading text lines from a terminal.** If the open file is associated with a terminal (i.e., a keyboard and display), then each `read` function will transfer one text line at a time, returning a short count equal to the size of the text line.

**Reading and writing network sockets.** If the open file corresponds to a network socket ([Section 11.4](#)), then internal

buffering constraints and long network delays can cause `read` and `write` to return short counts. Short counts can also occur when you call `read` and `write` on a Linux *pipe*, an interprocess communication mechanism that is beyond our scope.

In practice, you will never encounter short counts when you read from disk files except on EOF, and you will never encounter short counts when you write to disk files. However, if you want to build robust (reliable) network applications such as Web servers, then you must deal with short counts by repeatedly calling `read` and `write` until all requested bytes have been transferred.

[OceanofPDF.com](http://OceanofPDF.com)

## 10.5 Robust Reading and Writing with the R<sub>IO</sub> Package

In this section, we will develop an I/O package, called the R<sub>IO</sub> (Robust I/O) package, that handles these short counts for you automatically. The R<sub>IO</sub> package provides convenient, robust, and efficient I/O in applications such as network programs that are subject to short counts. R<sub>IO</sub> provides two different kinds of functions:

**Unbuffered input and output functions.** These functions transfer data directly between memory and a file, with no application-level buffering. They are especially useful for reading and writing binary data to and from networks.

**Buffered input functions.** These functions allow you to efficiently read text lines and binary data from a file whose contents are cached in an application-level buffer, similar to the one provided for standard I/O functions such as `printf`. Unlike the buffered I/O routines presented in [110], the buffered R<sub>IO</sub> input functions are thread-safe ([Section 12.7.1](#)) and can be interleaved arbitrarily on the same descriptor. For example, you can read some text lines from a descriptor, then some binary data, and then some more text lines.

We are presenting the `RIO` routines for two reasons. First, we will be using them in the network applications we develop in the next two chapters. Second, by studying the code for these routines, you will gain a deeper understanding of Unix I/O in general.




## 10.5.1 `RIO` Unbuffered Input and Output Functions

Applications can transfer data directly between memory and a file by calling the `rio_readn` and `rio_writen` functions.

```
#include "csapp.h"
ssize_t rio_readn(int fd, void *usrbuf, size_t n);
ssize_t rio_writen(int fd, void *usrbuf, size_t n);
Returns: number of bytes
transferred if OK, 0 on EOF (rio_readn only), -1 on error
```

The `rio_readn` function transfers up to `n` bytes from the current file position of descriptor `fd` to memory location `usrbuf`. Similarly, the `rio_writen` function transfers `n` bytes from location `usrbuf` to descriptor `fd`. The `rio_readn` function can only return a short count if it encounters EOF. The `rio_writen` function never returns a short count. Calls to `rio_readn` and `rio_writen` can be interleaved arbitrarily on the same descriptor.

**Figure 10.4**  shows the code for `rio_readn` and `rio_writen`. Notice that each function manually restarts the `read` or `write` function if it is interrupted by the return from an application signal handler. To be as

portable as possible, we allow for interrupted system calls and restart them when necessary.

## 10.5.2 `RIO` Buffered Input Functions

Suppose we wanted to write a program that counts the number of lines in a text file. How might we do this? One approach is to use the `read` function to transfer 1 byte at a time from the file to the user's memory, checking each byte for the newline character. The disadvantage of this approach is that it is inefficient, requiring a trap to the kernel to read each byte in the file.

A better approach is to call a wrapper function (`rio_readlineb`) that copies the text line from an internal *read buffer*, automatically making a read call to refill the buffer whenever it becomes empty. For files that contain both text lines and binary data (such as the HTTP responses described in [Section 11.5.3](#)), we also provide a buffered version of `rio_readn`, called `rio_readnb`, that transfers raw bytes from the same read buffer as `rio_readlineb`.

```

|
#include "csapp.h"
void rio_readinitb(rio_t *rp, int fd);

Returns: nothing
ssize_t rio_readlineb(rio_t *rp, void *usrbuf, size_t maxlen);
ssize_t rio_readnb(rio_t *rp, void *usrbuf, size_t n);

Returns: number of bytes
read if OK, 0 on EOF, -1 on error


```


The `rio_readinitb` function is called once per open descriptor. It associates the descriptor `fd` with a read buffer of type `rio_t` at address `rp`.

The `rio_readlineb` function reads the next text line from file `rp` (including the terminating newline character), copies it to memory location `usrbuf`, and terminates the text line with the NULL (zero) character. The `rio_readlineb` function reads at most `maxlen-1` bytes, leaving room for the terminating NULL character. Text lines that exceed `maxlen-1` bytes are truncated and terminated with a NULL character.

The `rio_readnb` function reads up to `n` bytes from file `rp` to memory location `usrbuf`. Calls to `rio_readlineb` and `rio_readnb` can be interleaved arbitrarily on the same descriptor. However, calls to these

buffered functions should not be interleaved with calls to the unbuffered `rio_readn` function.

You will encounter numerous examples of the `Rio` functions in the remainder of this text. **Figure 10.5**  shows how to use the `Rio` functions to copy a text file from standard input to standard output, one line at a time.

**Figure 10.6**  shows the format of a read buffer, along with the code for the `rio_readinitb` function that initializes it. The `rio_readinitb` function sets up an empty read buffer and associates an open file descriptor with that buffer.

```

1     ssize_t rio_readn(int fd, void *usrbuf, size_t n)
2     {
3         size_t nleft = n;
4         ssize_t nread;
5         char *bufp = usrbuf;
6
7         while (nleft > 0) {
8             if ((nread = read(fd, bufp, nleft)) < 0)
9                 if (errno == EINTR) /*
Interrupted by sig handler return */
10                    nread = 0;
/* and call read() again */
11                else
12                    return -1; /* errno
set by read() */
13            }
14            else if (nread == 0)
15                break; /*EOF */
16            nleft -= nread;
17            bufp += nread;
18        }
19        return (n - nleft); /*
Return >= 0 */
20    }

```

```

1      ssize_t rio_writen(int fd, void *usrbuf, size_t n)
2      {
3          size_t nleft = n;
4          ssize_t nwritten;
5          char *bufp = usrbuf;
6
7          while (nleft > 0) {
8              if ((nwritten = write(fd, bufp, nleft))
9  <= 0) {
10                 if (errno == EINTR) /*
11                    Interrupted by sig handler return */
12                     nwritten = 0; /* and
13                    call write() again */
14                 else
15                     return -1; /* errno
16                    set by write() */
17             }
18             nleft -= nwritten;
19             bufp += nwritten;
20         }
21         return n;
22     }

```

Figure 10.4 The `rio_readn` and `rio_writen` functions.

```
|  
1     #include "csapp.h"  
2  
3     int main(int argc, char **argv)  
4     {  
5         int n;  
6         rio_t rio;  
7         char buf[MAXLINE];  
8  
9         Rio_readinitb(&rio, STDIN_FILENO);  
10        while((n = Rio_readlineb(&rio, buf, MAXLINE)) !=  
11        0)  
12            Rio_writen(STDOUT_FILENO, buf, n);  
13    }
```

**Figure 10.5** Copying a text file from standard input to standard output.



```

1  #define RIO_BUFSIZE 8192
2  typedef struct {
3      int rio_fd;          /* Descriptor
for this internal buf */
4      int rio_cnt;        /* Unread bytes
in internal buf */
5      char *rio_bufptr;   /* Next unread
byte in internal buf */
6      char rio_buf[RIO_BUFSIZE]; /* Internal
buffer */
7  } rio_t;

```

```

1  void rio_readinitb(rio_t *rp, int fd)
2  {
3      rp->rio_fd = fd;
4      rp->rio_cnt = 0;
5      rp->rio_bufptr = rp->rio_buf;
6  }

```

**Figure 10.6** A read buffer of type `rio_t` and the `rio_readinitb` function that initializes it.

The heart of the Rio read routines is the `rio_read` function shown in [Figure 10.7](#). The `rio_read` function is a buffered version of the

Linux `read` function. When `rio_read` is called with a request to read `n` bytes, there are `rp->rio_cnt` unread bytes in the read buffer. If the buffer is empty, then it is replenished with a call to `read`. Receiving a short count from this invocation of `read` is not an error; it simply has the effect of partially filling the read buffer. Once the buffer is

```

1     static ssize_t rio_read(rio_t *rp, char *usrbuf, size_t
n)
2     {
3         int cnt;
4
5         while (rp->rio_cnt <= 0) { /* Refill if buf is
empty */
6             rp->rio_cnt = read(rp->rio_fd, rp-
>rio_buf,
7
sizeof(rp->rio_buf));
8             if (rp->rio_cnt < 0) {
9                 if (errno != EINTR) /*
Interrupted by sig handler return */
10                    return -1;
11            }
12            else if (rp->rio_cnt == 0) /* EOF */
13                return 0;
14            else
15                rp->rio_bufptr = rp->rio_buf; /*
Reset buffer ptr */
16        }
17
18        /* Copy min(n, rp->rio_cnt) bytes from internal
buf to user buf */
19        cnt = n;
20        if (rp->rio_cnt < n)

```

```

21         cnt = rp->rio_cnt;
22         memcpy(usrbuf, rp->rio_bufptr, cnt);
23         rp->rio_bufptr += cnt;
24         rp->rio_cnt -= cnt;
25         return cnt;
26     }

```

**Figure 10.7** The internal `rio_read` function.

nonempty, `rio_read` copies the minimum of `n` and `rp->rio_cnt` bytes from the read buffer to the user buffer and returns the number of bytes copied.

To an application program, the `rio_read` function has the same semantics as the Linux `read` function. On error, it returns `-1` and sets `errno` appropriately. On EOF, it returns `0`. It returns a short count if the number of requested bytes exceeds the number of unread bytes in the read buffer. The similarity of the two functions makes it easy to build different kinds of buffered read functions by substituting `rio_read` for `read`. For example, the `rio_readnb` function in [Figure 10.8](#) has the same structure as `rio_readn`, with `rio_read` substituted for `read`. Similarly, the `rio_readlineb` routine in [Figure 10.8](#) calls `rio_read` at most `maxlen-1` times. Each call returns 1 byte from the read buffer, which is then checked for being the terminating newline.

```

1      ssize_t rio_readlineb(rio_t *rp, void *usrbuf, size_t
maxlen)
2      {
3          int n, rc;
4          char c, *bufp = usrbuf;
5
6          for (n = 1; n < maxlen; n++) {
7              if ((rc = rio_read(rp, &c, 1)) == 1) {
8                  *bufp++ = c;
9                  if (c == '\n') {
10                     n++;
11                     break;
12                 }
13             } else if (rc == 0) {
14                 if (n == 1)
15                     return 0;          /* EOF,
no data read */
16                 else
17                     break;            /* EOF,
some data was read */
18             } else
19                 return -1;           /* Error
*/
20         }
21         *bufp = 0;
22         return n-1;
23     }

```

```

1      ssize_t rio_readnb(rio_t *rp, void *usrbuf, size_t n)
2      {
3          size_t nleft = n;
4          ssize_t nread;
5          char *bufp = usrbuf;
6
7          while (nleft > 0) {
8              if ((nread = rio_read(rp, bufp, nleft)) < 0)
9                  return -1;      /* errno set by read()
*/
10             else if (nread == 0)
11                 break;          /*EOF */
12             nleft -= nread;
13             bufp += nread;
14         }
15         return (n - nleft);      /* Return >= 0 */
16     }

```

**Figure 10.8** The `rio_readlineb` and `rio_readnb` functions.

## Aside Origins of the Rio package

The `Rio` functions are inspired by the `readline`, `readn`, and `writen` functions described by W. Richard Stevens in his classic network programming text [110]. The `rio_readn` and `rio_writen` functions are identical to the Stevens `readn` and `writen` functions. However, the Stevens `readline` function has some limitations that are corrected in `Rio`. First, because `readline` is buffered and `readn` is not, these two functions cannot be used together on the same descriptor. Second, because it uses a `static` buffer, the Stevens `readline` function is not thread-safe, which required Stevens to introduce a different thread-safe version called `readline_r`. We have corrected both of these flaws with the `rio_readlineb` and `rio_readnb` functions, which are mutually compatible and thread-safe.

## 10.6 Reading File Metadata

An application can retrieve information about a file (sometimes called the file's *metadata*) by calling the `stat` and `fstat` functions.

```
|  
#include <unistd.h>  
#include <sys/stat.h>  
int stat(const char *filename, struct stat *buf);  
int fstat(int fd, struct stat *buf);  
Returns: 0 if OK, -1 on  
error
```

The `stat` function takes as input a filename and fills in the members of a `stat` structure shown in [Figure 10.9](#). The `fstat` function is similar, but it takes a file descriptor instead of a filename. We will need the `st_mode` and `st_size` members of the `stat` structure when we discuss Web servers in [Section 11.5](#). The other members are beyond our scope.


The `st_size` member contains the file size in bytes. The `st_mode` member encodes both the file permission bits ([Figure 10.2](#)) and the file type ([Section 10.2](#)). Linux defines macro predicates in `sys/stat.h` for determining the file type from the `st_mode` member:



`S_ISREG(m)`. Is this a regular file?

`S_ISDIR(m)`. Is this a directory file?

`S_ISSOCK(m)`. Is this a network socket?

**Figure 10.10**  shows how we might use these macros and the `stat` function to read and interpret a file's `st_mode` bits.

```

|
/* Metadata returned by the stat and fstat functions */
struct stat {
    dev_t      st_dev;      /* Device */
    ino_t      st_ino;     /* inode */
    mode_t     st_mode;    /* Protection and file
type */
    nlink_t    st_nlink;   /* Number of hard links
*/
    uid_t      st_uid;     /* User ID of owner */
    gid_t      st_gid;     /* Group ID of owner */
    dev_t      st_rdev;    /* Device type (if inode
device) */
    off_t      st_size;    /* Total size, in bytes
*/
    unsigned long st_blksize; /* Block size for
filesystem I/O */
    unsigned long st_blocks; /* Number of blocks
allocated */
    time_t     st_atime;   /* Time of last access
*/
    time_t     st_mtime;   /* Time of last
modification */
    time_t     st_ctime;   /* Time of last change
*/
};

```

Figure 10.9 The `stat` structure.

```

1  #include "csapp.h"
2
3  int main (int argc, char **argv)
4  {
5      struct stat stat;
6      char *type, *readok;
7
8      Stat(argv[1], &stat);
9      if (S_ISREG(stat.st_mode)) /* Determine
file type */
10         type = "regular";
11     else if (S_ISDIR(stat.st_mode))
12         type = "directory";
13     else
14         type = "other";
15     if ((stat.st_mode & S_IRUSR) /* Check read
access */
16         readok = "yes";
17     else
18         readok = "no";
19
20     printf("type: %s, read: %s\n", type, readok);
21     exit(0);
22 }

```

**Figure 10.10** Querying and manipulating a file's `st_mode` bits.

[OceanofPDF.com](http://OceanofPDF.com)

## 10.7 Reading Directory Contents

Applications can read the contents of a directory with the `readdir` family of functions.

```
|
#include <sys/types.h>
#include <dirent.h>
DIR *opendir(const char *name);
Returns: pointer to
handle if OK, NULL on error
```

The `opendir` function takes a pathname and returns a pointer to a *directory stream*. A stream is an abstraction for an ordered list of items, in this case a list of directory entries.

```
|
#include <dirent.h>
struct dirent *readdir(DIR *dirp);
Returns: pointer to next
directory entry if OK, NULL if no more entries or error
```


Each call to `readdir` returns a pointer to the next directory entry in the stream `dirp`, or NULL if there are no more entries. Each directory entry is a structure of the form

```
|
|
| struct dirent {
|     ino_t d_ino;    /* inode number */
|     char d_name[256]; /* Filename */
| };
```

Although some versions of Linux include other structure members, these are the only two that are standard across all systems. The `d_name` member is the filename, and `d_ino` is the file location.

On error, `readdir` returns NULL and sets `errno`. Unfortunately, the only way to distinguish an error from the end-of-stream condition is to check if `errno` has been modified since the call to `readdir`.

```
|
| #include <dirent.h>
| int closedir(DIR *dirp);
| Returns: 0 on success, -1 on error
```

The `closedir` function closes the stream and frees up any of its resources. [Figure 10.11](#)  shows how we might use `readdir` to read

the contents of a directory.

```
1  #include "csapp.h"
2
3  int main(int argc, char **argv)
4  {
5      DIR *stream;
6      struct dirent *dep;
7
8      stream = opendir(argv[1]);
9
10     errno = 0;
11     while ((dep = readdir(stream)) != NULL) {
12         printf("Found file: %s\n", dep->d_name);
13     }
14     if (errno != 0)
15         unix_error("readdir error");
16
17     closedir(stream);
18     exit(0);
19 }
```

Figure 10.11 Reading the contents of a directory.



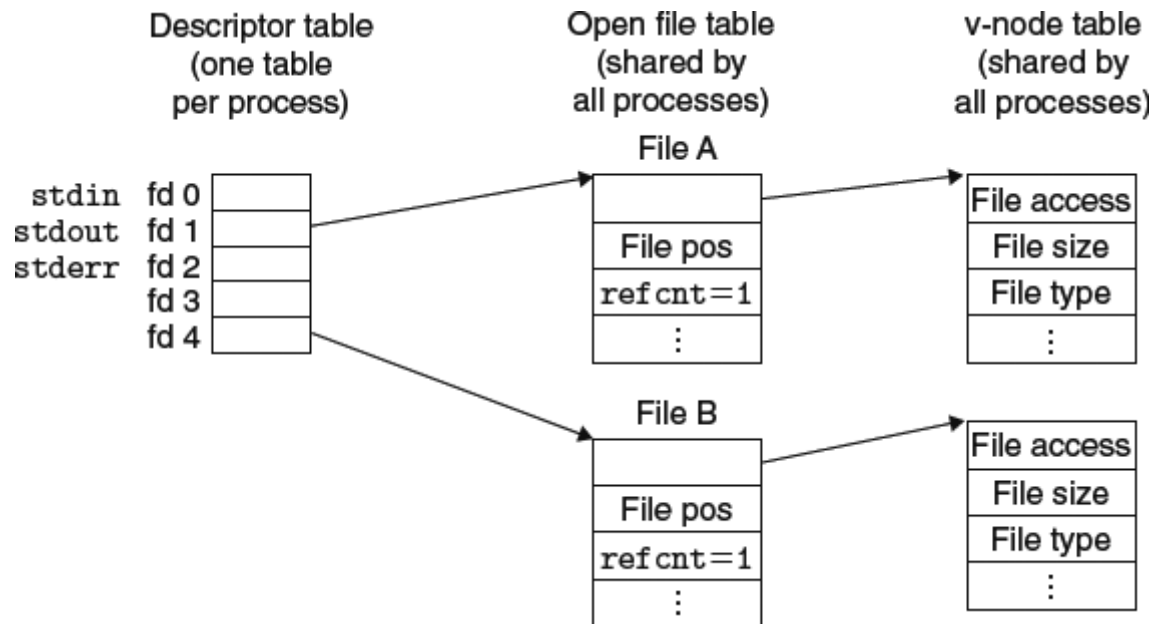
## 10.8 Sharing Files

Linux files can be shared in a number of different ways. Unless you have a clear picture of how the kernel represents open files, the idea of file sharing can be quite confusing. The kernel represents open files using three related data structures:

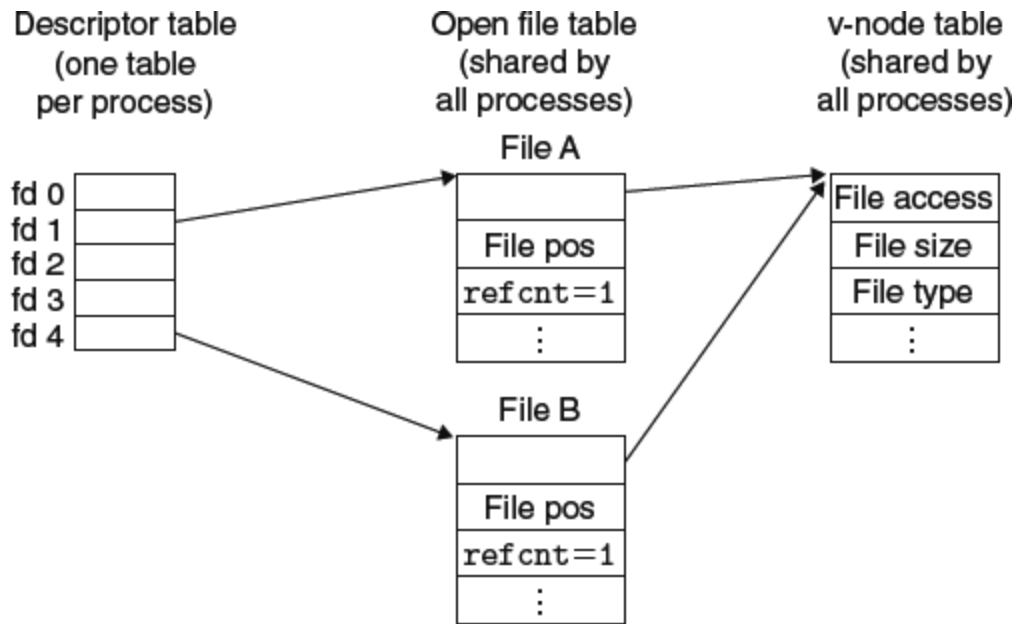
**Descriptor table.** Each process has its own separate *descriptor table* whose entries are indexed by the process's open file descriptors. Each open descriptor entry points to an entry in the *file table*.

**File table.** The set of open files is represented by a file table that is shared by all processes. Each file table entry consists of (for our purposes) the current file position, a *reference count* of the number of descriptor entries that currently point to it, and a pointer to an entry in the *v-node table*. Closing a descriptor decrements the reference count in the associated file table entry. The kernel will not delete the file table entry until its reference count is zero.

**v-node table.** Like the file table, the v-node table is shared by all processes. Each entry contains most of the information in the `stat` structure, including the `st_mode` and `st_size` members.



**Figure 10.12 Typical kernel data structures for open files.**  
 In this example, two descriptors reference distinct files. There is no sharing.



**Figure 10.13 File sharing.**

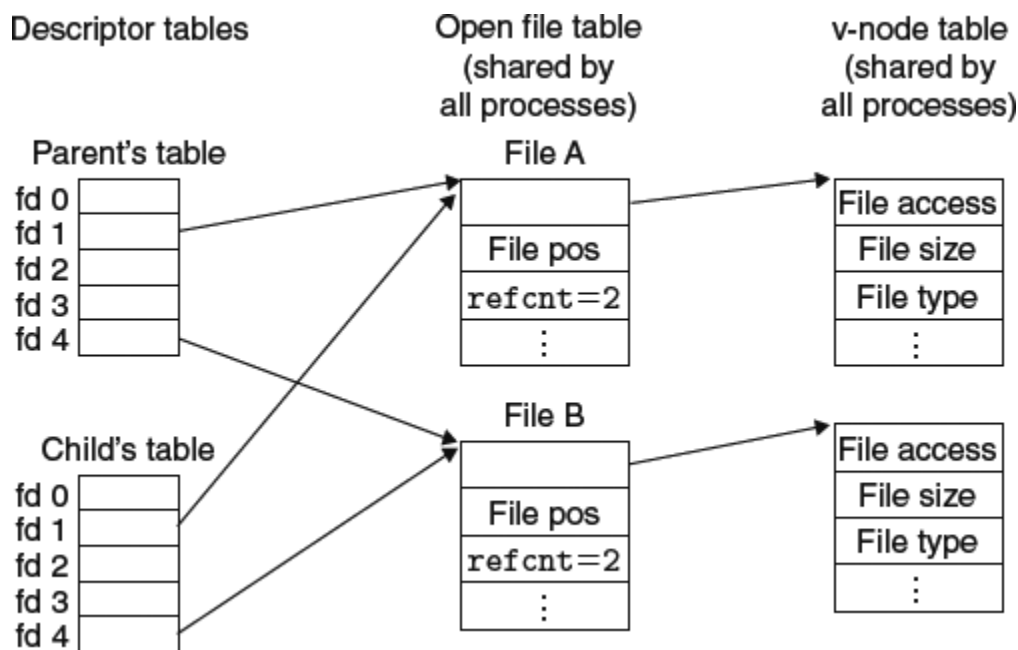
This example shows two descriptors sharing the same disk file through two open file table entries.

**Figure 10.12** [📄](#) shows an example where descriptors 1 and 4 reference two different files through distinct open file table entries. This is the typical situation, where files are not shared and where each descriptor corresponds to a distinct file.

Multiple descriptors can also reference the same file through different file table entries, as shown in **Figure 10.13** [📄](#). This might happen, for example, if you were to call the `open` function twice with the same filename. The key idea is that each descriptor has its own distinct file position, so different reads on different descriptors can fetch data from different locations in the file.

We can also understand how parent and child processes share files. Suppose that before a call to `fork`, the parent process has the open files shown in [Figure 10.12](#). Then [Figure 10.14](#) shows the situation after the call to `fork`.

The child gets its own duplicate copy of the parent's descriptor table. Parent and child share the same set of open file tables and thus share the same file position. An important consequence is that the parent and child must both close their descriptors before the kernel will delete the corresponding file table entry.



**Figure 10.14** How a child process inherits the parent's open files.

The initial situation is in [Figure 10.12](#).

# Practice Problem 10.2 (solution page 915)

Suppose the disk file `foobar.txt` consists of the six ASCII characters `foobar`. Then what is the output of the following program?

```
|
1     #include "csapp.h"
2
3     int main()
4     {
5         int fd1, fd2;
6         char c;
7
8         fd1 = Open("foobar.txt", O_RDONLY, 0);
9         fd2 = Open("foobar.txt", O_RDONLY, 0);
10        Read(fd1, &c, 1);
11        Read(fd2, &c, 1);
12        printf("c = %c\n", c);
13        exit(0);
14    }
```

# Practice Problem 10.3 (solution page 915)

As before, suppose the disk file `foobar.txt` consists of the six ASCII characters `foobar`. Then what is the output of the following program?

```
|
1  #include "csapp.h"
2
3  int main()
4  {
5      int fd;
6      char c;
7
8      fd = Open("foobar.txt", O_RDONLY, 0);
9      if (Fork() == 0) {
10         Read(fd, &c, 1);
11         exit(0);
12     }
13     Wait(NULL);
14     Read(fd, &c, 1);
15     printf("c = %c\n", c);
16     exit(0);
17 }
```

[OceanofPDF.com](http://OceanofPDF.com)

## 10.9 I/O Redirection

Linux shells provide *I/O redirection* operators that allow users to associate standard input and output with disk files. For example, typing

```
linux> ls > foo.txt
```

causes the shell to load and execute the `ls` program, with standard output redirected to disk file `foo.txt`. As we will see in [Section 11.5](#), a Web server performs a similar kind of redirection when it runs a CGI program on behalf of the client. So how does I/O redirection work? One way is to use the `dup2` function.

```
|  
#include <unistd.h>  
int dup2(int oldfd, int newfd);  
Returns: nonnegative  
descriptor if OK, -1 on error
```

The `dup2` function copies descriptor table entry `oldfd` to descriptor table entry `newfd`, overwriting the previous contents of descriptor



table entry `newfd`. If `newfd` was already open, then `dup2` closes `newfd` before it copies `oldfd`.

Suppose that before calling `dup2(4, 1)`, we have the situation in [Figure 10.12](#), where descriptor 1 (standard output) corresponds to file A (say, a terminal) and descriptor 4 corresponds to file B (say, a disk file). The reference counts for A and B are both equal to 1. [Figure 10.15](#) shows the situation after calling `dup2(4, 1)`. Both descriptors now point to file B; file A has been closed and its file table and v-node table entries deleted; and the reference count for file B has been incremented. From this point on, any data written to standard output are redirected to file B.

## Practice Problem 10.4 (solution page **915**)

How would you use `dup2` to redirect standard input to descriptor 5?

### Aside Right and left hoinkies

To avoid confusion with other bracket-type operators such as `]` and `[`, we have always referred to the shell's `>` operator as a "right hoinky" and the `<` operator as a "left hoinky."

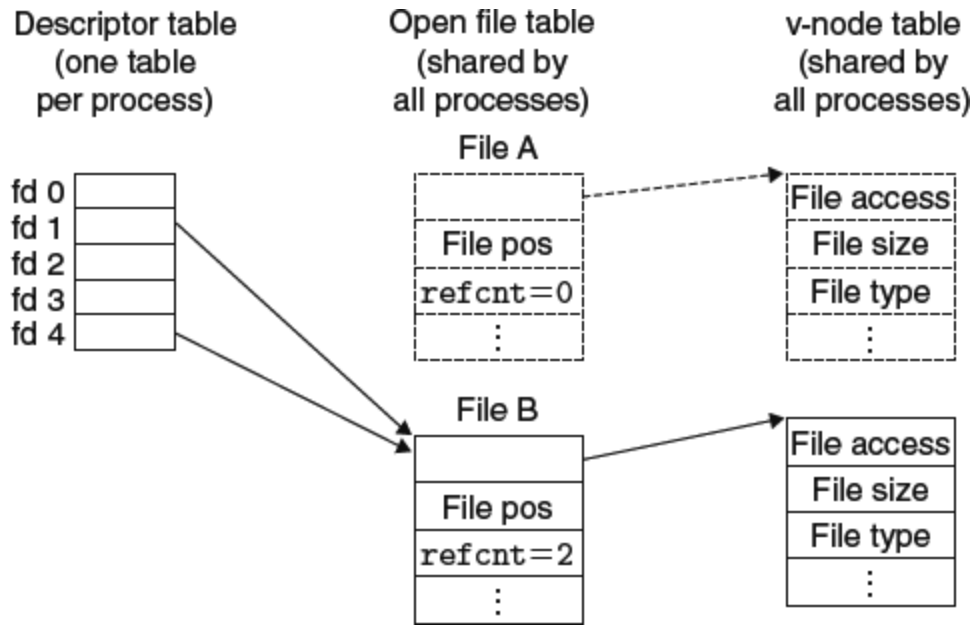


Figure 10.15 Kernel data structures after redirecting standard output by calling `dup2(4, 1)`.

The initial situation is shown in [Figure 10.12](#).

# Practice Problem 10.5 (solution page 916)

Assuming that the disk file `foobar.txt` consists of the six ASCII characters `foobar`, what is the output of the following program?

```
|
1  #include "csapp.h"
2
3  int main()
4  {
5      int fd1, fd2;
6      char c;
7
8      fd1 = Open("foobar.txt", O_RDONLY, 0);
9      fd2 = Open("foobar.txt", O_RDONLY, 0);
10     Read(fd2, &c, 1);
11     Dup2(fd2, fd1);
12     Read(fd1, &c, 1);
13     printf("c = %c\n", c);
14     exit(0);
15 }
```

## 10.10 Standard I/O

The C language defines a set of higher-level input and output functions, called the *standard I/O library*, that provides programmers with a higher-level alternative to Unix I/O. The library (`libc`) provides functions for opening and closing files (`fopen` and `fclose`), reading and writing bytes (`fread` and `fwrite`), reading and writing strings (`fgets` and `fputs`), and sophisticated formatted I/O (`scanf` and `printf`).

The standard I/O library models an open file as a *stream*. To the programmer, a stream is a pointer to a structure of type `FILE`. Every ANSI C program begins with three open streams, `stdin`, `stdout`, and `stderr`, which correspond to standard input, standard output, and standard error, respectively:

```
|  
#include <stdio.h>  
extern FILE *stdin;          /* Standard input (descriptor 0)  
*/  
extern FILE *stdout;        /* Standard output (descriptor  
1) */  
extern FILE *stderr;        /* Standard error (descriptor 2)  
*/
```

A stream of type FILE is an abstraction for a file descriptor and a *stream buffer*. The purpose of the stream buffer is the same as the R<sub>IO</sub> read buffer: to minimize the number of expensive Linux I/O system calls. For example, suppose we have a program that makes repeated calls to the standard I/O `getc` function, where each invocation returns the next character from a file. When `getc` is called the first time, the library fills the stream buffer with a single call to the `read` function and then returns the first byte in the buffer to the application. As long as there are unread bytes in the buffer, subsequent calls to `getc` can be served directly from the stream buffer.

# 10.11 Putting It Together: Which I/O Functions Should I Use?

Figure 10.16 summarizes the various I/O packages that we have discussed in this chapter.

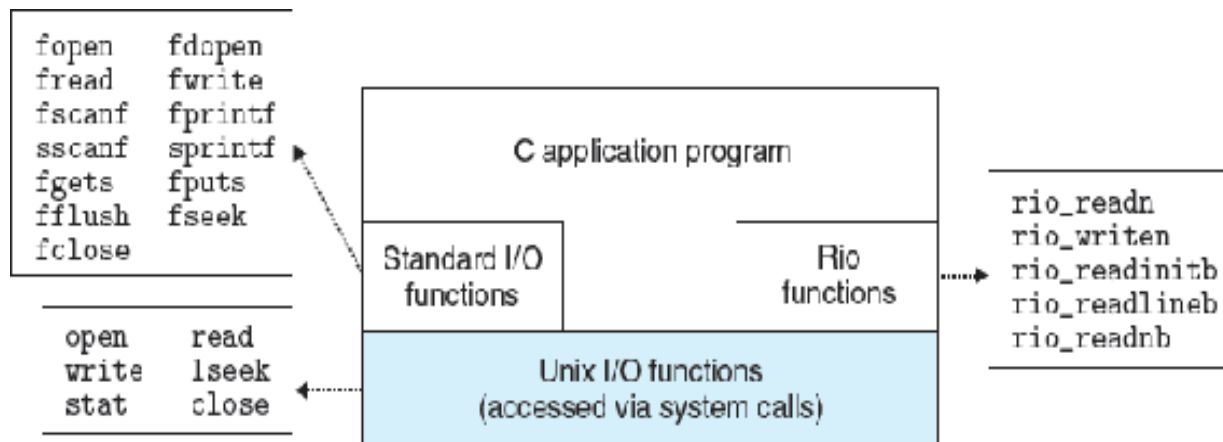


Figure 10.16 Relationship between Unix I/O, standard I/O, and Rio.

The Unix I/O model is implemented in the operating system kernel. It is available to applications through functions such as `open`, `close`, `lseek`, `read`, `write`, and `stat`. The higher-level Rio and standard I/O functions are implemented "on top of" (using) the Unix I/O functions. The Rio functions are robust wrappers for `read` and `write` that were developed specifically for this textbook. They automatically deal with short counts and provide an efficient buffered approach for reading

text lines. The standard I/O functions provide a more complete buffered alternative to the Unix I/O functions, including formatted I/O routines such as `printf` and `scanf`.

So which of these functions should you use in your programs? Here are some basic guidelines:

**G1: Use the standard I/O functions whenever possible.** The standard I/O functions are the method of choice for I/O on disk and terminal devices. Most C programmers use standard I/O exclusively throughout their careers, never bothering with the lower-level Unix I/O functions (except possibly `stat`, which has no counterpart in the standard I/O library). Whenever possible, we recommend that you do likewise.

**G2: Don't use `scanf` or `rio_readlineb` to read binary files.**

Functions like `scanf` and `rio_readlineb` are designed specifically for reading text files. A common error that students make is to use these functions to read binary data, causing their programs to fail in strange and unpredictable ways. For example, binary files might be littered with many `0xa` bytes that have nothing to do with terminating text lines.

**G3: Use the `Rio` functions for I/O on network sockets.**

Unfortunately, standard I/O poses some nasty problems when we attempt to use it for input and output on networks. As we will see in [Section 11.4](#), the Linux abstraction for a network is a type of file called a *socket*. Like any Linux file, sockets are referenced by file descriptors, known in this case as *socket descriptors*.

Application processes communicate with processes running on other computers by reading and writing socket descriptors.

Standard I/O streams are *full duplex* in the sense that programs can perform input and output on the same stream. However, there are poorly documented restrictions on streams that interact badly with restrictions on sockets:

**Restriction 1: Input functions following output functions.** An input function cannot follow an output function without an intervening call to `fflush`, `fseek`, `fsetpos`, or `rewind`. The `fflush` function empties the buffer associated with a stream. The latter three functions use the Unix I/O `lseek` function to reset the current file position.

**Restriction 2: Output functions following input functions.** An output function cannot follow an input function without an intervening call to `fseek`, `fsetpos`, or `rewind`, unless the input function encounters an end-of-file.


These restrictions pose a problem for network applications because it is illegal to use the `lseek` function on a socket. The first restriction on stream I/O can be worked around by adopting a discipline of flushing the buffer before every input operation. However, the only way to work around the second restriction is to open two streams on the same open socket descriptor, one for reading and one for writing:



```
|  
FILE *fpin, *fpout;  
fpin = fdopen(sockfd, "r");  
fpout = fdopen(sockfd, "w");
```

But this approach has problems as well, because it requires the application to call `fclose` on both streams in order to free the memory resources associated with each stream and avoid a memory leak:

```
|  
fclose(fpin);  
fclose(fpout);
```

Each of these operations attempts to close the same underlying socket descriptor, so the second `fclose` operation will fail. This is not a problem for sequential programs, but closing an already closed descriptor in a threaded program is a recipe for disaster (see [Section 12.7.4](#) .

Thus, we recommend that you not use the standard I/O functions for input and output on network sockets. Use the robust `RIO` functions instead. If you need formatted output, use the `sprintf` function to format a string in memory, and then send it to the socket using `rio_writen`. If you need formatted input, use `rio_readlineb` to read

an entire text line, and then use `sscanf` to extract different fields from the text line.

[OceanofPDF.com](http://OceanofPDF.com)

## 10.12 Summary

Linux provides a small number of system-level functions, based on the Unix I/O model, that allow applications to open, close, read, and write files, to fetch file metadata, and to perform I/O redirection. Linux read and write operations are subject to short counts that applications must anticipate and handle correctly. Instead of calling the Unix I/O functions directly, applications should use the `RIO` package, which deals with short counts automatically by repeatedly performing read and write operations until all of the requested data have been transferred.

The Linux kernel uses three related data structures to represent open files. Entries in a descriptor table point to entries in the open file table, which point to entries in the v-node table. Each process has its own distinct descriptor table, while all processes share the same open file and v-node tables. Understanding the general organization of these structures clarifies our understanding of both file sharing and I/O redirection.

The standard I/O library is implemented on top of Unix I/O and provides a powerful set of higher-level I/O routines. For most applications, standard I/O is the simpler, preferred alternative to Unix I/O. However, because of some mutually incompatible restrictions on standard I/O and network files, Unix I/O, rather than standard I/O, should be used for network applications.

[OceanofPDF.com](http://OceanofPDF.com)

# Bibliographic Notes

Kerrisk gives a comprehensive treatment of Unix I/O and the Linux file system [62]. Stevens wrote the original standard reference text for Unix I/O [111]. Kernighan and Ritchie give a clear and complete discussion of the standard I/O functions [61].

[OceanofPDF.com](http://OceanofPDF.com)

# Homework Problems

## 10.6

What is the output of the following program?

```
1  #include "csapp.h"
2
3  int main()
4  {
5      int fd1, fd2;
6
7      fd1 = Open("foo.txt", O_RDONLY, 0);
8      fd2 = Open("bar.txt", O_RDONLY, 0);
9      Close(fd2);
10     fd2 = Open("baz.txt", O_RDONLY, 0);
11     printf("fd2 = %d\n", fd2);
12     exit(0);
13 }
```


## 10.7

Modify the `cpfile` program in [Figure 10.5](#) so that it uses the `Rio` functions to copy standard input to standard output, `MAXBUF` bytes at a time.

## 10.8

Write a version of the `statcheck` program in [Figure 10.10](#), called `fstatcheck`, that takes a descriptor number on the command line rather than a filename.

# 10.9

Consider the following invocation of the `fstatcheck` program from **Problem 10.8** :

```
linux> fstatcheck 3 < foo.txt
```

You might expect that this invocation of `fstatcheck` would fetch and display metadata for file `foo.txt`. However, when we run it on our system, it fails with a "bad file descriptor." Given this behavior, fill in the pseudocode that the shell must be executing between the `fork` and `execve` calls:

```
|  
if (Fork() == 0) { /* child */  
    /* What code is the shell executing right here? */  
    Execve("fstatcheck", argv, envp);  
}
```



# 10.10

Modify the `cpfile` program in [Figure 10.5](#) so that it takes an optional command-line argument `infile`. If `infile` is given, then copy `infile` to standard output; otherwise, copy standard input to standard output as before. The twist is that your solution must use the original copy loop (lines 9–11) for both cases. You are only allowed to insert code, and you are not allowed to change any of the existing code.

[OceanofPDF.com](http://OceanofPDF.com)

# Solutions to Practice Problems

## Solution to Problem 10.1 [↗](#)(page 895)

Unix processes begin life with open descriptors assigned to `stdin` (descriptor 0), `stdout` (descriptor 1), and `stderr` (descriptor 2). The `open` function always returns the lowest unopened descriptor, so the first call to `open` returns descriptor 3. The call to the `close` function frees up descriptor 3. The final call to `open` returns descriptor 3, and thus the output of the program is `fd2 = 3`.

# Solution to Problem 10.2 (page 908)

The descriptors `fd1` and `fd2` each have their own open file table entry, so each descriptor has its own file position for `foobar.txt`. Thus, the read from `fd2` reads the first byte of `foobar.txt`, and the output is

```
|  
c = f
```

and not

```
|  
c = o
```

as you might have thought initially.

## Solution to Problem 10.3 [↗](#)(page 908)

Recall that the child inherits the parent's descriptor table and that all processes shared the same open file table. Thus, the descriptor `fd` in both the parent and child points to the same open file table entry. When the child reads the first byte of the file, the file position increases by 1. Thus, the parent reads the second byte, and the output is

```
c = 0
```

## Solution to Problem 10.4 [↗](#)(page 909)

To redirect standard input (descriptor 0) to descriptor 5, we would call `dup2(5, 0)`, or equivalently, `dup2(5, STDIN_FILENO)`.

# Solution to Problem 10.5 <sup>□</sup>(page 910)

At first glance, you might think the output would be

```
c = f
```

but because we are redirecting `fd1` to `fd2`, the output is really

```
c = 0
```

---

# Chapter **11** Network Programming

---

**11.1 The Client-Server Programming Model 918** 

**11.2 Networks 919** 

**11.3 The Global IP Internet 924** 

**11.4 The Sockets Interface 932** 

**11.5 Web Servers 948** 

**11.6 Putting It Together: The Tiny Web Server 956** 

**11.7 Summary 964** 

**Bibliographic Notes 965** 

**Homework Problems 965** 

**Solutions to Practice Problems 966** 


*Network applications are everywhere. Any time you browse the Web, send an email message, or play an online game, you are using a network application. Interestingly, all network applications are based on the same basic programming model, have similar overall logical structures, and rely on the same programming interface.*

*Network applications rely on many of the concepts that you have already learned in our study of systems. For example, processes, signals, byte ordering, memory mapping, and dynamic storage allocation all play important roles. There are new concepts to master as well. You will need to understand the basic client-server programming model and how to write client-server programs that use the services provided by the Internet. At the end, we will tie all of these ideas together by developing a tiny but functional Web server that can serve both static and dynamic content with text and graphics to real Web browsers.*



# 11.1 The Client-Server Programming Model

Every network application is based on the *client-server model*. With this model, an application consists of a *server* process and one or more *client* processes. A server manages some *resource*, and it provides some *service* for its clients by manipulating that resource. For example, a Web server manages a set of disk files that it retrieves and executes on behalf of clients. An FTP server manages a set of disk files that it stores and retrieves for clients. Similarly, an email server manages a spool file that it reads and updates for clients.

The fundamental operation in the client-server model is the *transaction* ([Figure 11.1](#) ). A client-server transaction consists of four steps:

1. When a client needs service, it initiates a transaction by sending a *request* to the server. For example, when a Web browser needs a file, it sends a request to a Web server.
2. The server receives the request, interprets it, and manipulates its resources in the appropriate way. For example, when a Web server receives a request from a browser, it reads a disk file.

3. The server sends a *response* to the client and then waits for the next request. For example, a Web server sends the file back to a client.

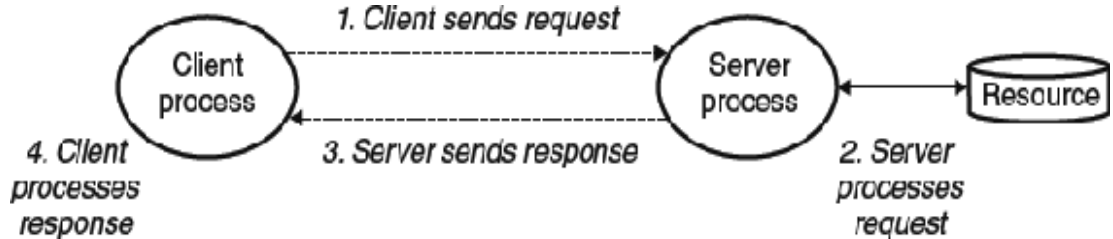


Figure 11.1 A client-server transaction.

## Aside Client-server transactions versus database transactions

Client-server transactions are *not* database transactions and do not share any of their properties, such as atomicity. In our context, a transaction is simply a sequence of steps carried out by a client and a server.

4. The client receives the response and manipulates it. For example, after a Web browser receives a page from the server, it displays it on the screen.


It is important to realize that clients and servers are processes and not machines, or *hosts* as they are often called in this context. A single host can run many different clients and servers concurrently, and a client and server transaction can be on the same or different

hosts. The client-server model is the same, regardless of the mapping of clients and servers to hosts.

[OceanofPDF.com](http://OceanofPDF.com)

## 11.2 Networks

Clients and servers often run on separate hosts and communicate using the hardware and software resources of a *computer network*. Networks are sophisticated systems, and we can only hope to scratch the surface here. Our aim is to give you a workable mental model from a programmer's perspective.

To a host, a network is just another I/O device that serves as a source and sink for data, as shown in [Figure 11.2](#) .

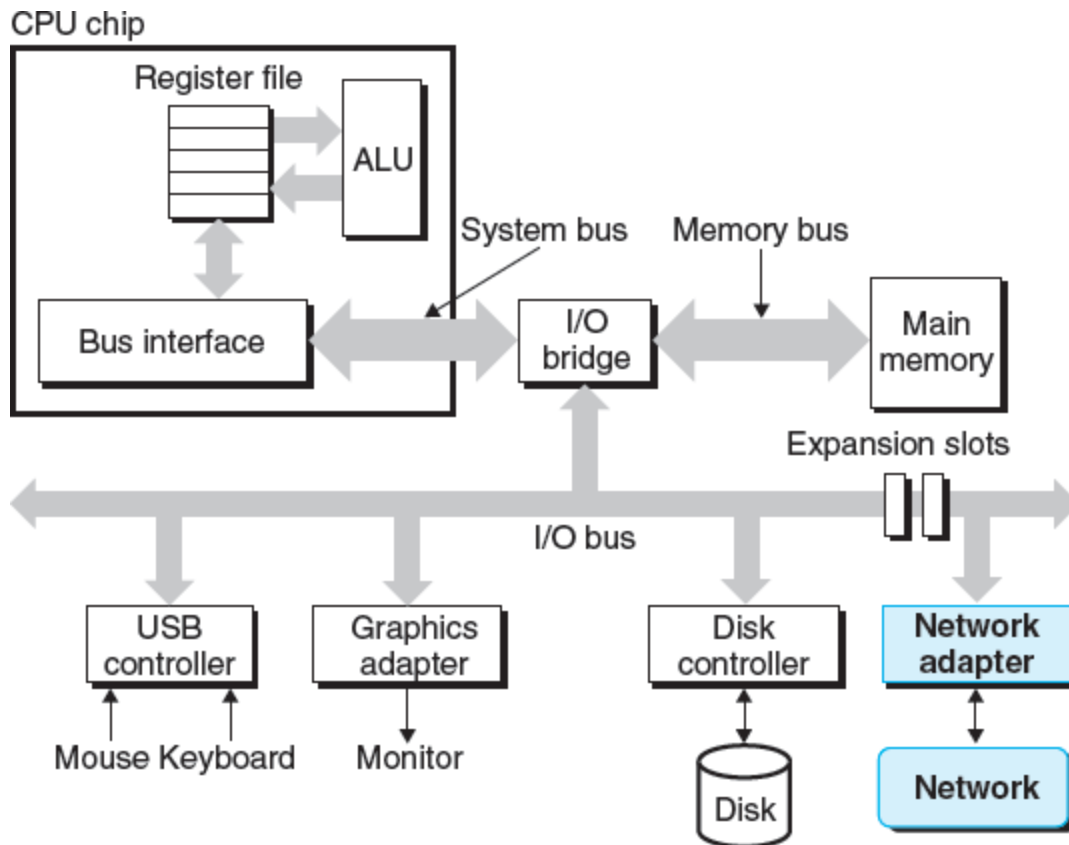


Figure 11.2 Hardware organization of a network host.

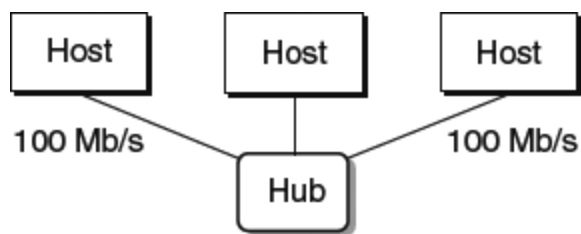




Figure 11.3 Ethernet segment.

An adapter plugged into an expansion slot on the I/O bus provides the physical interface to the network. Data received from the network are copied from the adapter across the I/O and memory buses into memory, typically by a DMA transfer. Similarly, data can also be copied from memory to the network.

Physically, a network is a hierarchical system that is organized by geographical proximity. At the lowest level is a LAN (local area network) that spans a building or a campus. The most popular LAN technology by far is *Ethernet*, which was developed in the mid-1970s at Xerox PARC. Ethernet has proven to be remarkably resilient, evolving from 3 Mb/s to 10 Gb/s.

An *Ethernet segment* consists of some wires (usually twisted pairs of wires) and a small box called a *hub*, as shown in [Figure 11.3](#) . Ethernet segments typically span small areas, such as a room or a floor in a building. Each wire has the same maximum bit bandwidth, typically 100 Mb/s or 1 Gb/s. One end is attached to an adapter on a host, and the other end is attached to a *port* on the hub. A hub slavishly copies every bit that it receives on each port to every other port. Thus, every host sees every bit.

Each Ethernet adapter has a globally unique 48-bit address that is stored in a nonvolatile memory on the adapter. A host can send a chunk of bits called a *frame* to any other host on the segment. Each frame includes some fixed number of *header* bits that identify the source and destination of the frame and the frame length, followed by a *payload* of data bits. Every host adapter sees the frame, but only the destination host actually reads it.

Multiple Ethernet segments can be connected into larger LANs, called *bridged Ethernets*, using a set of wires and small boxes called *bridges*, as shown in [Figure 11.4](#) . Bridged Ethernets can span entire buildings or campuses. In a bridged Ethernet, some wires

connect bridges to bridges, and others connect bridges to hubs. The bandwidths of the wires can be different. In our example, the bridge-bridge wire has a 1 Gb/s bandwidth, while the four hub-bridge wires have bandwidths of 100 Mb/s.

Bridges make better use of the available wire bandwidth than hubs. Using a clever distributed algorithm, they automatically learn over time which hosts are reachable from which ports and then selectively copy frames from one port to another only when it is necessary. For example, if host A sends a frame to host B, which is on the segment, then bridge X will throw away the frame when it arrives at its input port, thus saving bandwidth on the other segments. However, if host A sends a frame to host C on a different segment, then bridge X will copy the frame only to the port connected to bridge Y, which will copy the frame only to the port connected to host C's segment.

## Aside Internet versus internet

We will always use lowercase *internet* to denote the general concept, and uppercase *Internet* to denote a specific implementation—namely, the global IP Internet.

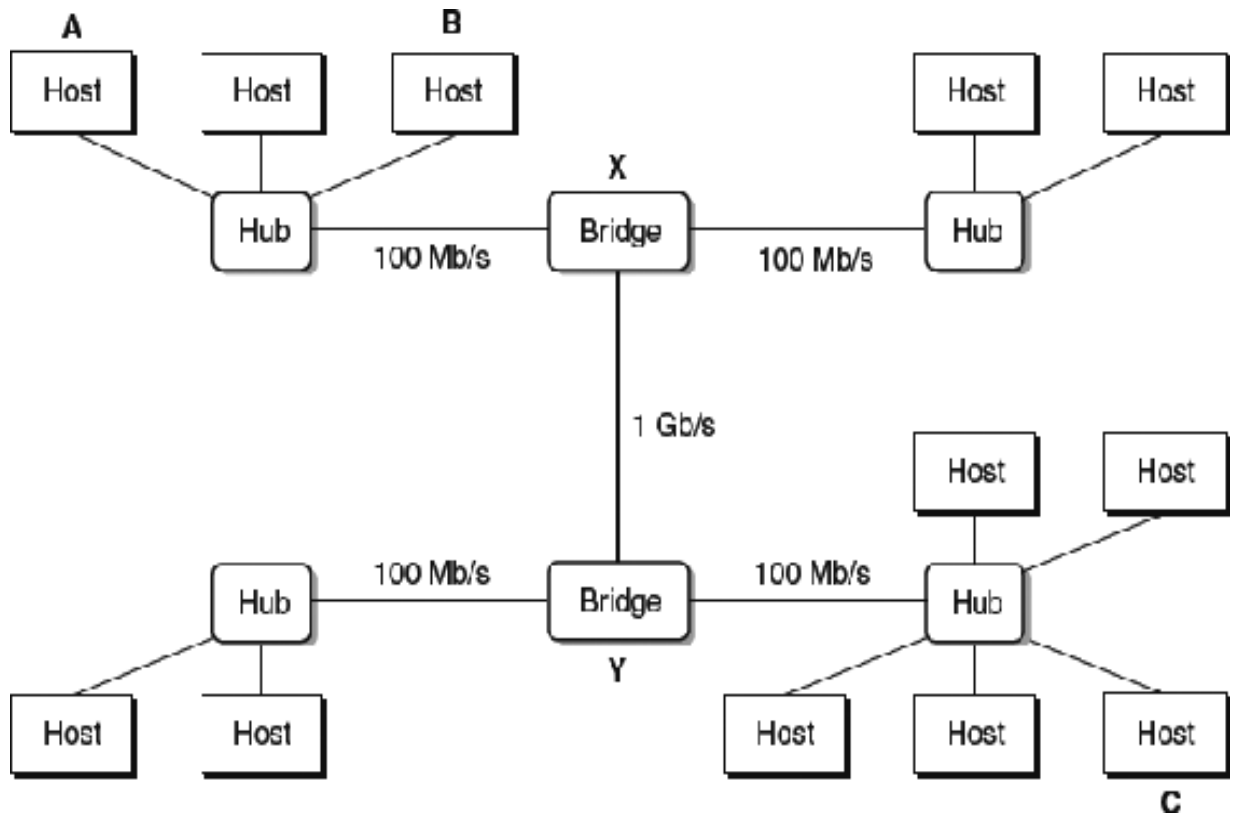


Figure 11.4 Bridged Ethernet segments.

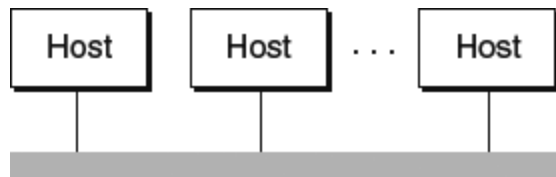


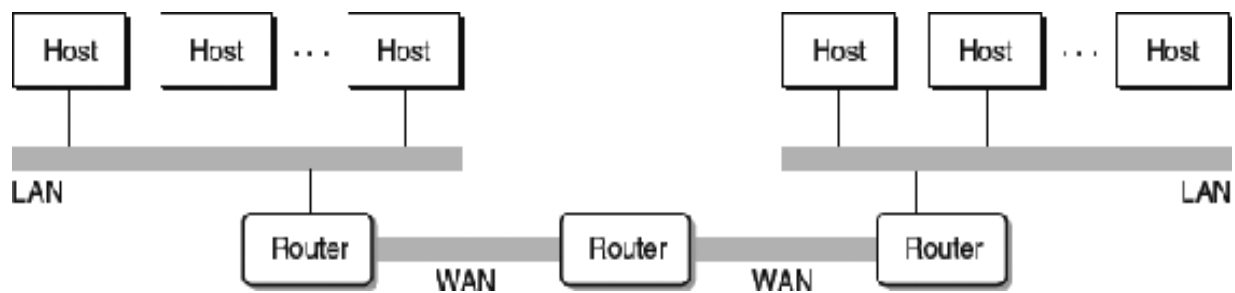
Figure 11.5 Conceptual view of a LAN.

To simplify our pictures of LANs, we will draw the hubs and bridges and the wires that connect them as a single horizontal line, as shown in [Figure 11.5](#).

At a higher level in the hierarchy, multiple incompatible LANs can be connected by specialized computers called *routers* to form an *internet* (interconnected network). Each router has an adapter (port)



for each network that it is connected to. Routers can also connect high-speed point-to-point phone connections, which are examples of networks known as WANs (wide area networks), so called because they span larger geographical areas than LANs. In general, routers can be used to build internets from arbitrary collections of LANs and WANs. For example, [Figure 11.6](#) shows an example internet with a pair of LANs and WANs connected by three routers.



**Figure 11.6** A small internet.


Two LANs and two WANs are connected by three routers.

The crucial property of an internet is that it can consist of different LANs and WANs with radically different and incompatible technologies. Each host is physically connected to every other host, but how is it possible for some *source host* to send data bits to another *destination host* across all of these incompatible networks?

The solution is a layer of *protocol software* running on each host and router that smoothes out the differences between the different networks. This software implements a *protocol* that governs how hosts and routers cooperate in order to transfer data. The protocol must provide two basic capabilities:

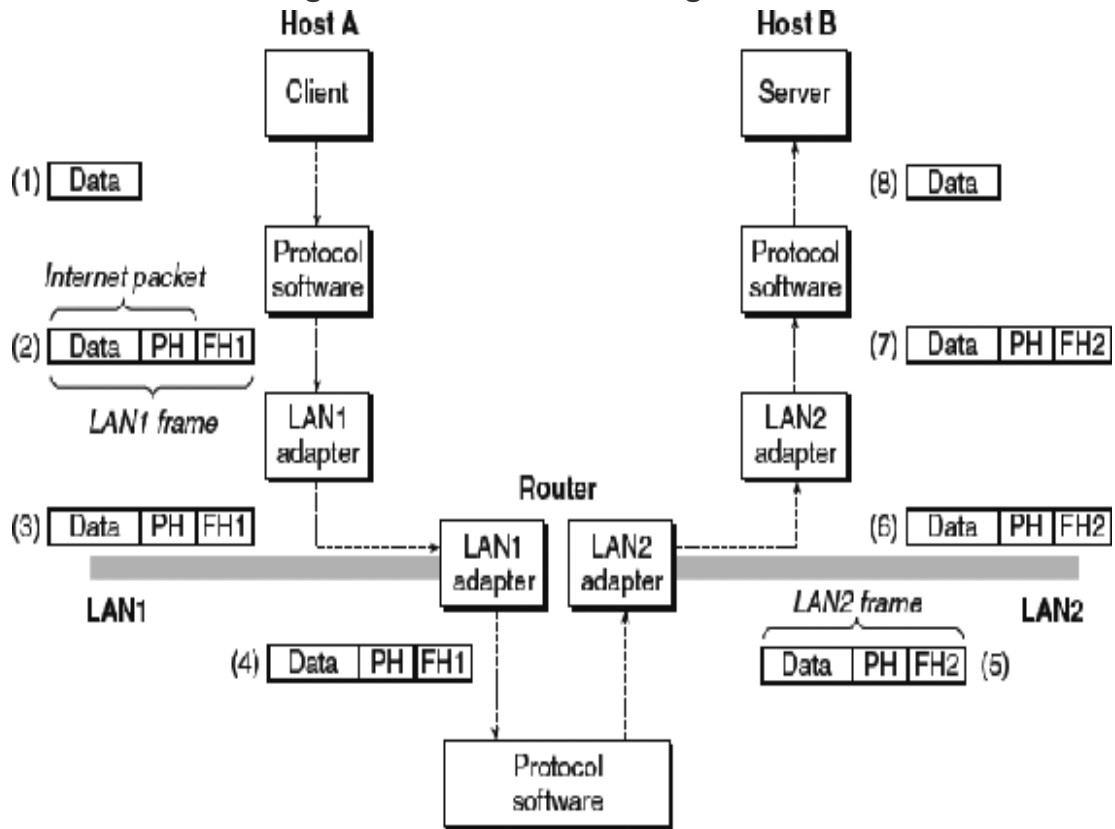
**Naming scheme.** Different LAN technologies have different and incompatible ways of assigning addresses to hosts. The internet protocol smoothes these differences by defining a uniform format for host addresses. Each host is then assigned at least one of these *internet addresses* that uniquely identifies it.

**Delivery mechanism.** Different networking technologies have different and incompatible ways of encoding bits on wires and of packaging these bits into frames. The internet protocol smoothes these differences by defining a uniform way to bundle up data bits into discrete chunks called *packets*. A packet consists of a *header*, which contains the packet size and addresses of the source and destination hosts, and a *payload*, which contains data bits sent from the source host.

**Figure 11.7**  shows an example of how hosts and routers use the internet protocol to transfer data across incompatible LANs. The example internet consists of two LANs connected by a router. A client running on host A, which is attached to LAN1, sends a sequence of data bytes to a server running on host B, which is attached to LAN2. There are eight basic steps:

1. The client on host A invokes a system call that copies the data from the client's virtual address space into a kernel buffer.
2. The protocol software on host A creates a LAN1 frame by appending an internet header and a LAN1 frame header to the data. The internet header is addressed to internet host B. The LAN1 frame header is addressed to the router. It then

passes the frame to the adapter. Notice that the payload of the LAN1 frame is an internet packet, whose payload is the actual user data. This kind of *encapsulation* is one of the fundamental insights of internetworking.



**Figure 11.7** How data travel from one host to another on an internet.

PH: internet packet header; FH1: frame header for LAN1; FH2: frame header for LAN2.

3. The LAN1 adapter copies the frame to the network.
4. When the frame reaches the router, the router's LAN1 adapter reads it from the wire and passes it to the protocol software.
5. The router fetches the destination internet address from the internet packet header and uses this as an index into a

routing table to determine where to forward the packet, which in this case is LAN2. The router then strips off the old LAN1 frame header, prepends a new LAN2 frame header addressed to host B, and passes the resulting frame to the adapter.

6. The router's LAN2 adapter copies the frame to the network.
7. When the frame reaches host B, its adapter reads the frame from the wire and passes it to the protocol software.
8. Finally, the protocol software on host B strips off the packet header and frame header. The protocol software will eventually copy the resulting data into the server's virtual address space when the server invokes a system call that reads the data.

Of course, we are glossing over many difficult issues here. What if different networks have different maximum frame sizes? How do routers know where to forward frames? How are routers informed when the network topology changes? What if a packet gets lost? Nonetheless, our example captures the essence of the internet idea, and encapsulation is the key.

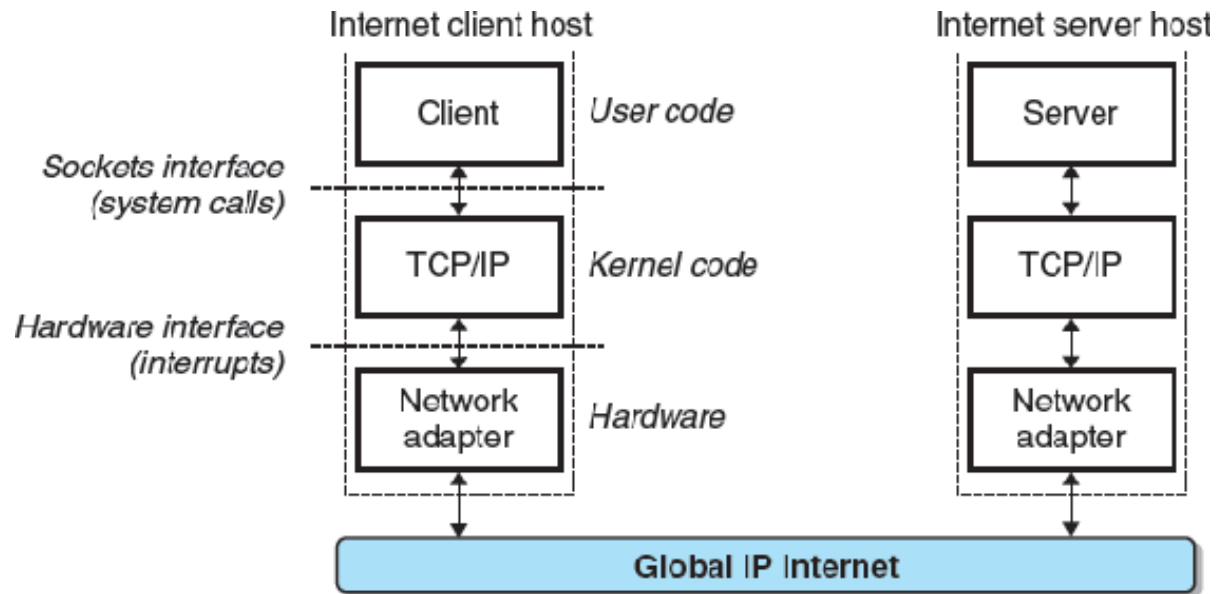




Figure 11.8 Hardware and software organization of an Internet application.

## 11.3 The Global IP Internet

The global IP Internet is the most famous and successful implementation of an internet. It has existed in one form or another since 1969. While the internal architecture of the Internet is complex and constantly changing, the organization of client-server applications has remained remarkably stable since the early 1980s. **Figure 11.8**  shows the basic hardware and software organization of an Internet client-server application.

Each Internet host runs software that implements the *TCP/IP* protocol (*Transmission Control Protocol/Internet Protocol*), which is supported by almost every modern computer system. Internet clients and servers communicate using a mix of *sockets interface* functions and Unix I/O functions. (We will describe the sockets interface in **Section 11.4** ) The sockets functions are typically implemented as system calls that trap into the kernel and call various kernel-mode functions in TCP/IP.

TCP/IP is actually a family of protocols, each of which contributes different capabilities. For example, IP provides the basic naming scheme and a delivery mechanism that can send packets, known as *datagrams*, from one Internet host to any other host. The IP mechanism is unreliable in the sense that it makes no effort to recover if datagrams are lost or duplicated in the network. UDP (Unreliable Datagram Protocol) extends IP slightly, so that

datagrams can be transferred from process to process, rather than host to host. TCP is a complex protocol that builds on IP to provide reliable full duplex (bidirectional) *connections* between processes. To simplify our discussion, we will treat TCP/IP as a single monolithic protocol. We will not discuss its inner workings, and we will only discuss some of the basic capabilities that TCP and IP provide to application programs. We will not discuss UDP.

From a programmer's perspective, we can think of the Internet as a worldwide collection of hosts with the following properties:

- The set of hosts is mapped to a set of 32-bit *IP addresses*.

## Aside IPv4 and IPv6

The original Internet protocol, with its 32-bit addresses, is known as Internet Protocol Version 4 (IPv4). In 1996, the Internet Engineering Task Force (IETF) proposed a new version of IP, called Internet Protocol Version 6 (IPv6), that uses 128-bit addresses and that was intended as the successor to IPv4. However, as of 2015, almost 20 years later, the vast majority of Internet traffic is still carried by IPv4 networks. For example, only 4 percent of users access Google services using IPv6 [42].


Because of its low adoption rate, we will not discuss IPv6 in any detail in this book and will focus exclusively on the concepts behind IPv4. When we talk about the Internet, what we mean is the Internet based on IPv4. Nonetheless, the techniques for writing clients and servers that we will teach you later in this chapter are based on modern interfaces that are independent of any particular protocol.

- The set of IP addresses is mapped to a set of identifiers called *Internet domain names*.
- A process on one Internet host can communicate with a process on any other Internet host over a *connection*.

The following sections discuss these fundamental Internet ideas in more detail.



## 11.3.1 IP Addresses

An IP address is an unsigned 32-bit integer. Network programs store IP addresses in the *IP address structure* shown in [Figure 11.9](#) .

Storing a scalar address in a structure is an unfortunate artifact from the early implementations of the sockets interface. It would make more sense to define a scalar type for IP addresses, but it is too late to change now because of the enormous installed base of applications.

Because Internet hosts can have different host byte orders, TCP/IP defines a uniform *network byte order* (big-endian byte order) for any integer data item, such as an IP address, that is carried across the network in a packet header. Addresses in IP address structures are always stored in (big-endian) network byte order, even if the host byte order is little-endian. Unix provides the following functions for converting between network and host byte order.

```

|
/* IP address structure */
struct in_addr {
    uint32_t s_addr; /* Address in network byte order (big-
endian) */
};

```

**Figure 11.9 IP address structure.**

```

|
#include <arpa/inet.h>
uint32_t htonl(uint32_t hostlong);
uint16_t htons(uint16_t hostshort);
Returns: value in
network byte order
uint32_t ntohl(uint32_t netlong);
uint16_t ntohs(uint16_t netshort);
Returns: value in host
byte order

```

The `htonl` function converts an unsigned 32-bit integer from host byte order to network byte order. The `ntohl` function converts an unsigned 32-bit integer from network byte order to host byte order. The `htons` and `ntohs` functions perform corresponding conversions

for unsigned 16-bit integers. Note that there are no equivalent functions for manipulating 64-bit values.

IP addresses are typically presented to humans in a form known as *dotted-decimal notation*, where each byte is represented by its decimal value and separated from the other bytes by a period. For example, `128.2.194.242` is the dotted-decimal representation of the address `0x8002c2f2`. On Linux systems, you can use the `HOSTNAME` command to determine the dotted-decimal address of your own host:

```
|  
linux> hostname -i  
128.2.210.175
```

Application programs can convert back and forth between IP addresses and dotted-decimal strings using the functions `inet_pton` and `inet_ntop`

```

|
#include <arpa/inet.h>

int inet_pton(AF_INET, const char *src, void *dst);
                                Returns: 1 if OK, 0 if src is
invalid dotted decimal, -1 on error

const char *inet_ntop(AF_INET, const void *src, char *dst,
socklen_t size);
                                Returns: pointer to a dotted-
decimal string if OK, NULL on error

```

In these function names, the "n" stands for *network* and the "p" stands for *presentation*. They can manipulate either 32-bit IPv4 addresses (`AF_INET`), as shown here, or 128-bit IPv6 addresses (`AF_INET6`), which we do not cover.

The `inet_pton` function converts a dotted-decimal string (`src`) to a binary IP address in network byte order (`dst`). If `src` does not point to a valid dotted-decimal string, then it returns 0. Any other error returns -1 and sets `errno`. Similarly, the `inet_ntop` function converts a binary IP address in network byte order (`src`) to the corresponding dotted-decimal representation and copies at most `size` bytes of the resulting null-terminated string to `dst`.

## *Practice Problem 11.1 (solution page 966)*

Complete the following table:

## *Practice Problem 11.2 (solution page 967)*

Write a program `hex2dd.c` that converts its hex argument to a dotted-decimal string and prints the result. For example,

```
|  
linux> ./hex2dd 0x8002c2f2  
128.2.194.242
```


## *Practice Problem 11.3 (solution page 967)*

Write a program `dd2hex.c` that converts its dotted-decimal argument to a hex number and prints the result. For example,

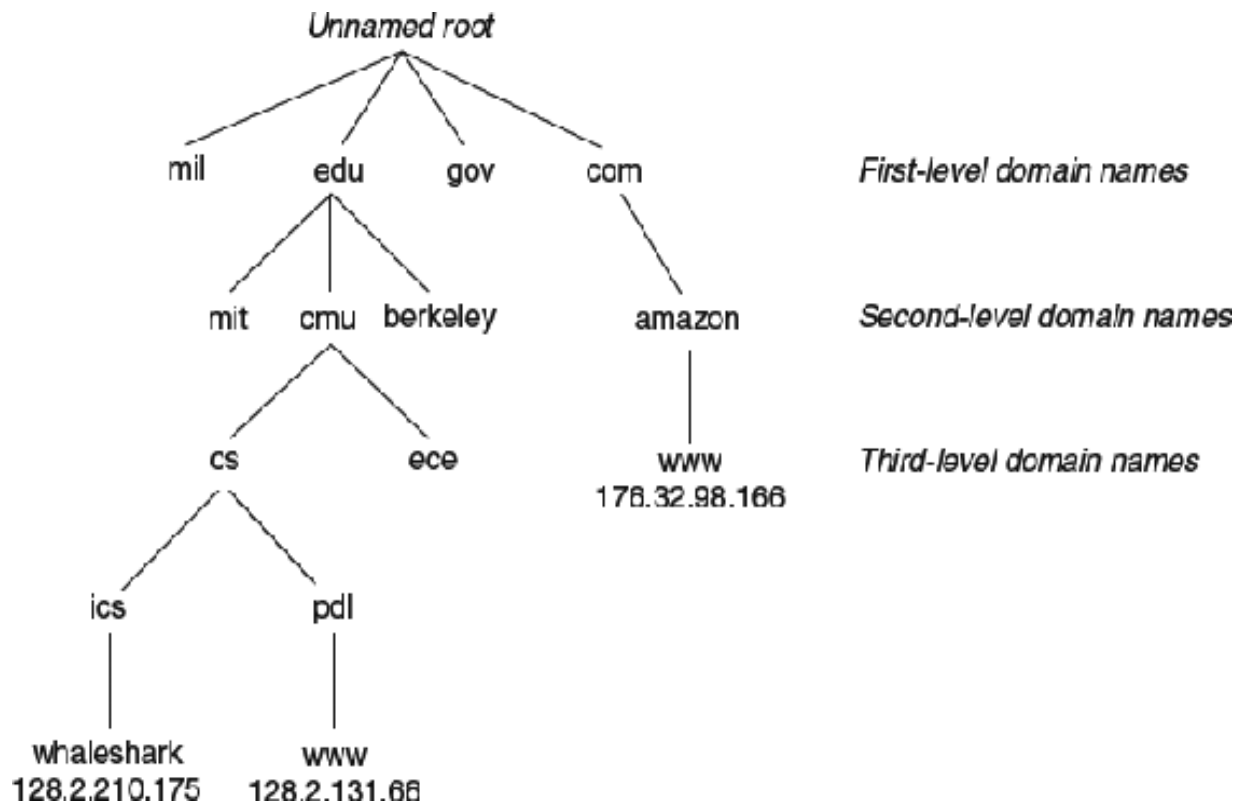
```
|  
linux> ./dd2hex 128.2.194.242  
0x8002c2f2
```

## 11.3.2 Internet Domain Names

Internet clients and servers use IP addresses when they communicate with each other. However, large integers are difficult for people to remember, so the Internet also defines a separate set of more human-friendly *domain names*, as well as a mechanism that maps the set of domain names to the set of IP addresses. A domain name is a sequence of words (letters, numbers, and dashes) separated by periods, such as `whaleshark.ics.cs.cmu.edu`.

The set of domain names forms a hierarchy, and each domain name encodes its position in the hierarchy. An example is the easiest way to understand this. **Figure 11.10**  shows a portion of the domain name hierarchy.

The hierarchy is represented as a tree. The nodes of the tree represent domain names that are formed by the path back to the root. Subtrees are referred to as *sub-domains*. The first level in the hierarchy is an unnamed root node. The next level is a collection of *first-level domain names* that are defined by a nonprofit organization called ICANN (Internet Corporation for Assigned Names and Numbers). Common first-level domains include `com`, `edu`, `gov`, `org`, and `net`.



**Figure 11.10** Subset of the Internet domain name hierarchy.

At the next level are *second-level* domain names such as `cmu.edu`, which are assigned on a first-come first-serve basis by various authorized agents of ICANN. Once an organization has received a second-level domain name, then it is free to create any other new domain name within its subdomain, such as `cs.cmu.edu`.

The Internet defines a mapping between the set of domain names and the set of IP addresses. Until 1988, this mapping was maintained manually in a single text file called `HOSTS.TXT`. Since then, the mapping has been maintained in a distributed worldwide database known as *DNS (Domain Name System)*. Conceptually, the DNS database consists of millions of *host entries*, each of which

defines the mapping between a set of domain names and a set of IP addresses. In a mathematical sense, think of each host entry as an equivalence class of domain names and IP addresses. We can explore some of the properties of the DNS mappings with the Linux `NSLOOKUP` program, which displays the IP addresses associated with a domain name.<sup>1</sup>

1. We've reformatted the output of `NSLOOKUP` to improve readability.

Each Internet host has the locally defined domain name `localhost`, which always maps to the *loopback address* `127.0.0.1`:

```
|  
linux> nslookup localhost  
Address: 127.0.0.1
```

The `localhost` name provides a convenient and portable way to reference clients and servers that are running on the same machine, which can be especially useful for debugging. We can use `HOSTNAME` to determine the real domain name of our local host:

```
|  
linux> hostname  
whaleshark.ics.cs.cmu.edu
```



In the simplest case, there is a one-to-one mapping between a domain name and an IP address:

```
|  
linux> nslookup whaleshark.ics.cs.cmu.edu  
Address: 128.2.210.175
```

However, in some cases, multiple domain names are mapped to the same IP address:

```
|  
linux> nslookup cs.mit.edu  
Address: 18.62.1.6  
linux> nslookup eecs.mit.edu  
Address: 18.62.1.6
```

In the most general case, multiple domain names are mapped to the same set of multiple IP addresses:

```
|  
linux> nslookup www.twitter.com
```

```
Address: 199.16.156.6
```

```
Address: 199.16.156.70
```

```
Address: 199.16.156.102
```

```
Address: 199.16.156.230
```

```
|  
linux> nslookup twitter.com
```

```
Address: 199.16.156.102
```

```
Address: 199.16.156.230
```

```
Address: 199.16.156.6
```

```
Address: 199.16.156.70
```

Finally, we notice that some valid domain names are not mapped to any IP address:

```
|  
linux> nslookup edu
```

```
*** Can't find edu: No answer
```

```
linux> nslookup ics.cs.cmu.edu
```

```
*** Can't find ics.cs.cmu.edu: No answer
```

## 11.3.3 Internet Connections

Internet clients and servers communicate by sending and receiving streams of bytes over *connections*. A connection is *point-to-point* in the sense that it connects a pair of processes. It is *full duplex* in the sense that data can flow in both directions

### Aside How many Internet hosts are there?

Twice a year since 1987, the Internet Systems Consortium conducts the *Internet Domain Survey*. The survey, which estimates the number of Internet hosts by counting the number of IP addresses that have been assigned a domain name, reveals an amazing trend. Since 1987, when there were about 20,000 Internet hosts, the number of hosts has been increasing exponentially. By 2015, there were over 1,000,000,000 Internet hosts!

at the same time. And it is *reliable* in the sense that—barring some catastrophic failure such as a cable cut by the proverbial careless backhoe operator—the stream of bytes sent by the source process is eventually received by the destination process in the same order it was sent.

A *socket* is an end point of a connection. Each socket has a corresponding *socket address* that consists of an Internet address

and a 16-bit integer *port*<sup>2</sup> and is denoted by the notation

```
address:port.
```

2. These software ports have no relation to the hardware ports in network switches and routers.

The port in the client's socket address is assigned automatically by the kernel when the client makes a connection request and is known as an *ephemeral port*. However, the port in the server's socket address is typically some *well-known port* that is permanently associated with the service. For example, Web servers typically use port 80, and email servers use port 25. Associated with each service with a well-known port is a corresponding *well-known service name*. For example, the well-known name for the Web service is `http`, and the well-known name for email is `smtp`. The mapping between well-known names and well-known ports is contained in a file called `/etc/services`.

A connection is uniquely identified by the socket addresses of its two end points. This pair of socket addresses is known as a *socket pair* and is denoted by the tuple

```
(cliaddr : cliport, servaddr :servport)
```

where *cliaddr* is the client's IP address, *cliport* is the client's port, *servaddr* is the server's IP address, and *servport* is the server's port.

For example, [Figure 11.11](#) shows a connection between a Web client and a Web server.

In this example, the Web client's socket address is

```
128.2.194.242:51213
```

where port `51213` is an ephemeral port assigned by the kernel. The Web server's socket address is

```
208.216.181.15:80
```

# Aside Origins of the Internet

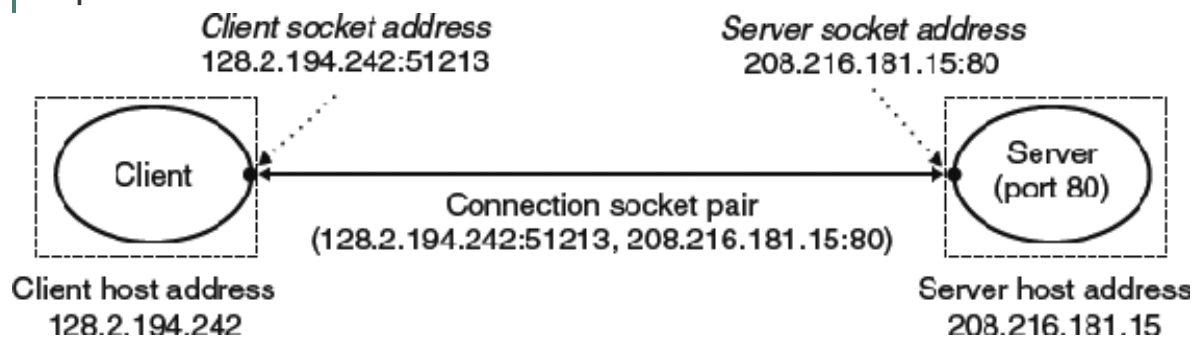
The Internet is one of the most successful examples of government, university, and industry partnership. Many factors contributed to its success, but we think two are particularly important: a sustained 30-year investment by the United States government and a commitment by passionate researchers to what Dave Clarke at MIT has dubbed "rough consensus and working code."

The seeds of the Internet were sown in 1957, when, at the height of the Cold War, the Soviet Union shocked the world by launching Sputnik, the first artificial earth satellite. In response, the United States government created the Advanced Research Projects Agency (ARPA), whose charter was to reestablish the US lead in science and technology. In 1967, Lawrence Roberts at ARPA published plans for a new network called the ARPANET. The first ARPANET nodes were up and running by 1969. By 1971, there were 13 ARPANET nodes, and email had emerged as the first important network application.

In 1972, Robert Kahn outlined the general principles of internetworking: a collection of interconnected networks, with communication between the networks handled independently on a "best-effort basis" by black boxes called "routers." In 1974, Kahn and Vinton Cerf published the first details of TCP/IP, which by 1982 had become the standard internetworking protocol for ARPANET. On January 1, 1983,

every node on the ARPANET switched to TCP/IP, marking the birth of the global IP Internet.

In 1985, Paul Mockapetris invented DNS, and there were over 1,000 Internet hosts. The next year, the National Science Foundation (NSF) built the NSFNET backbone connecting 13 sites with 56 Kb/s phone lines. It was upgraded to 1.5 Mb/s T1 links in 1988 and 45 Mb/s T3 links in 1991. By 1988, there were more than 50,000 hosts. In 1989, the original ARPANET was officially retired. In 1995, when there were almost 10,000,000 Internet hosts, NSF retired NSFNET and replaced it with the modern Internet architecture based on private commercial backbones connected by public network access points.



**Figure 11.11 Anatomy of an Internet connection.**

where port `80` is the well-known port associated with Web services. Given these client and server socket addresses, the connection between the client and server is uniquely identified by the socket pair

`(128.2.194.242:51213, 208.216.181.15:80)`


# Aside Origins of the sockets interface

The original sockets interface was developed by researchers at University of California, Berkeley, in the early 1980s. For this reason, it is often referred to as *Berkeley sockets*. The Berkeley researchers developed the sockets interface to work with any underlying protocol. The first implementation was for TCP/IP, which they included in the Unix 4.2BSD kernel and distributed to numerous universities and labs. This was an important event in Internet history. Almost overnight, thousands of people had access to TCP/IP and its source codes. It generated tremendous excitement and sparked a flurry of new research in networking and internetworking.

[OceanofPDF.com](http://OceanofPDF.com)



## 11.4 The Sockets Interface

The *sockets interface* is a set of functions that are used in conjunction with the Unix I/O functions to build network applications. It has been implemented on most modern systems, including all Unix variants as well as Windows and Macintosh systems. **Figure 11.12**  gives an overview of the sockets interface in the context of a typical client-server transaction. You should use this picture as a road map when we discuss the individual functions.

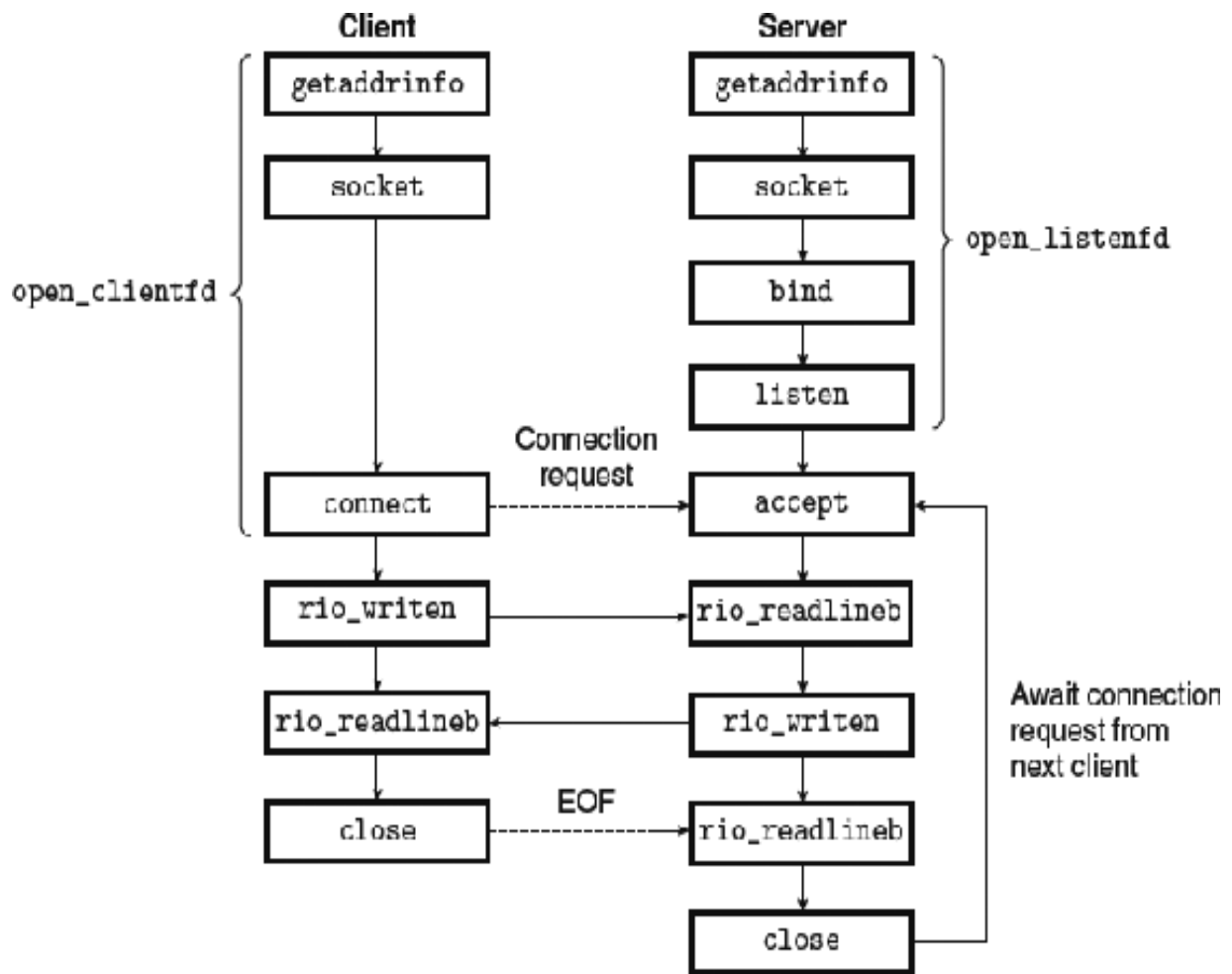


Figure 11.12 Overview of network applications based on the sockets interface.

Aside What does the `_in` suffix mean?

The `_in` suffix is short for *internet*, not *input*.

```

|
/* IP socket address structure */
struct sockaddr_in {
    uint16_t    sin_family;    /* Protocol family (always
AF_INET) */
    uint16_t    sin_port;     /* Port number in network byte
order */
    struct in_addr    sin_addr;    /* IP address in network
byte order */
    unsigned char sin_zero[8];    /* Pad to sizeof(struct
sockaddr) */
};
/* Generic socket address structure (for connect, bind, and
accept) */ struct sockaddr {
    uint16_t    sa_family;    /* Protocol family */
    char        sa_data[14];    /* Address data */
};

```

**Figure 11.13 Socket address structures.**

## 11.4.1 Socket Address Structures

From the perspective of the Linux kernel, a socket is an end point for communication. From the perspective of a Linux program, a socket is an open file with a corresponding descriptor.

Internet socket addresses are stored in 16-byte structures having the type `sockaddr_in`, shown in [Figure 11.13](#). For Internet applications, the `sin_family` field is `AF_INET`, the `sin_port` field is a 16-bit port number, and the `sin_addr` field contains a 32-bit IP address. The IP address and port number are always stored in network (big-endian) byte order.

The `connect`, `bind`, and `accept` functions require a pointer to a protocol-specific socket address structure. The problem faced by the designers of the sockets interface was how to define these functions to accept any kind of socket address structure. Today, we would use the generic `void *` pointer, which did not exist in C at that time. Their solution was to define sockets functions to expect a pointer to a generic `sockaddr` structure ([Figure 11.13](#)) and then require applications to cast any pointers to protocol-specific structures to this generic structure. To simplify our code examples, we follow Stevens's lead and define the following type:

```
typedef struct sockaddr SA;
```

We then use this type whenever we need to cast a `sockaddr_in` structure to a generic `sockaddr` structure.

## 11.4.2 The `socket` Function

Clients and servers use the `socket` function to create a *socket descriptor*.

```
|  
#include <sys/types.h>  
#include <sys/socket.h>  
int socket(int domain, int type, int protocol);  
Returns: nonnegative descriptor  
if OK, -1 on error
```

If we wanted the socket to be the end point for a connection, then we could call `socket` with the following hardcoded arguments:

```
clientfd = Socket(AF_INET, SOCK_STREAM, 0);
```

where `AF_INET` indicates that we are using 32-bit IP addresses and `SOCK_STREAM` indicates that the socket will be an end point for a connection. However, the best practice is to use the `getaddrinfo` function ([Section 11.4.7](#)) to generate these parameters automatically, so that the code is protocol-independent. We will show you how to use `getaddrinfo` with the `socket` function in [Section 11.4.8](#).

The `clientfd` descriptor returned by `socket` is only partially opened and cannot yet be used for reading and writing. How we finish opening the socket depends on whether we are a client or a server. The next section describes how we finish opening the socket if we are a client.

## 11.4.3 The `connect` Function

A client establishes a connection with a server by calling the `connect` function.


```
|  
#include <sys/socket.h>  
int connect(int clientfd, const struct sockaddr *addr,  
            socklen_t addrlen);  
Returns:  
0 if OK, -1 on error
```

The `connect` function attempts to establish an Internet connection with the server at socket address `addr`, where `addrlen` is `sizeof(sockaddr_in)`. The `connect` function blocks until either the connection is successfully established or an error occurs. If successful, the `clientfd` descriptor is now ready for reading and writing, and the resulting connection is characterized by the socket pair

```
(x:y, addr.sin_addr:addr.sin_port)
```

where `x` is the client's IP address and `y` is the ephemeral port that uniquely identifies the client process on the client host. As with




`socket`, the best practice is to use `getaddrinfo` to supply the arguments to `connect` (see [Section 11.4.8](#) .

## 11.4.4 The `bind` Function

The remaining sockets functions—`bind`, `listen`, and `accept`—are used by servers to establish connections with clients.

```
|  
#include <sys/socket.h>  
int bind(int sockfd, const struct sockaddr *addr, socklen_t  
addrlen);  
Returns: 0 if OK, -1 on error
```

The `bind` function asks the kernel to associate the server's socket address in `addr` with the socket descriptor `sockfd`. The `addrlen` argument is `sizeof(sockaddr_in)`. As with `socket` and `connect`, the best practice is to use `getaddrinfo` to supply the arguments to `bind` (see [Section 11.4.8](#) .

## 11.4.5 The `listen` Function

Clients are active entities that initiate connection requests. Servers are passive entities that wait for connection requests from clients. By default, the kernel assumes that a descriptor created by the `socket` function corresponds to an *active socket* that will live on the client end of a connection. A server calls the `listen` function to tell the kernel that the descriptor will be used by a server instead of a client.

```
#include <sys/socket.h>

int listen(int sockfd, int backlog);

Returns: 0 if OK, -1 on error
```

The `listen` function converts `sockfd` from an active socket to a *listening socket* that can accept connection requests from clients. The `backlog` argument is a hint about the number of outstanding connection requests that the kernel should queue up before it starts to refuse requests. The exact meaning of the `backlog` argument requires an understanding of TCP/IP that is beyond our scope. We will typically set it to a large value, such as 1,024.

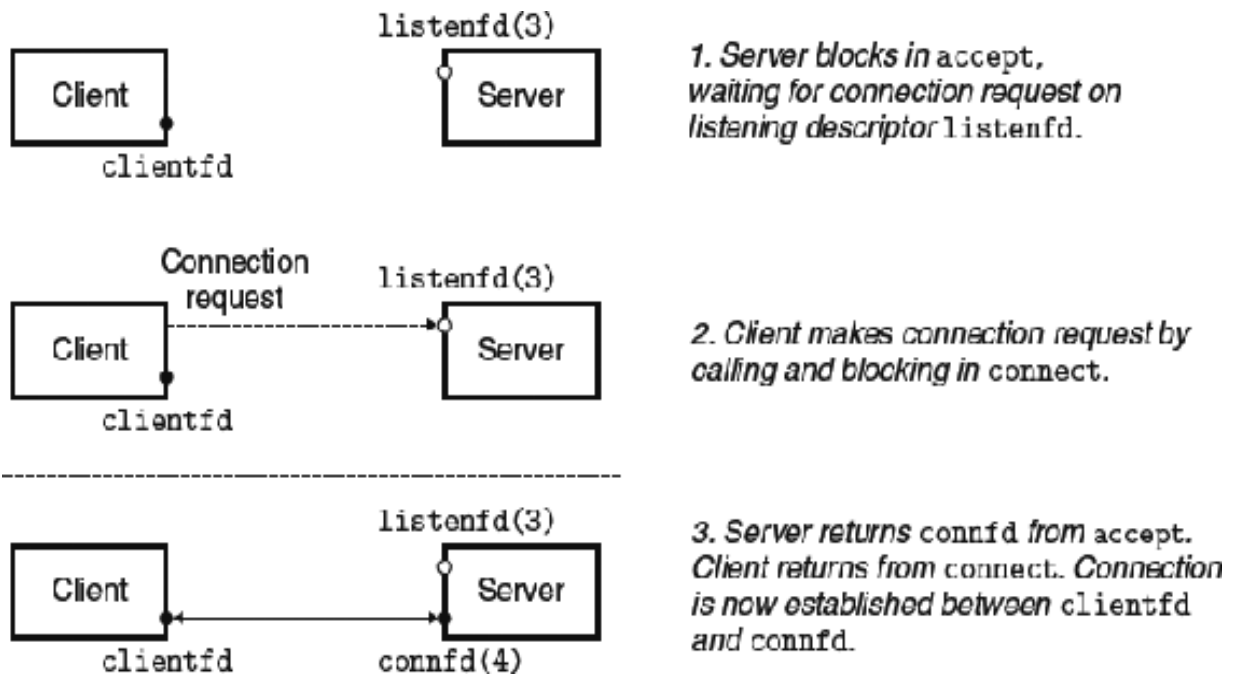


Figure 11.14 The roles of the listening and connected descriptors.


## 11.4.6 The `accept` Function

Servers wait for connection requests from clients by calling the `accept` function.

```
|  
#include <sys/socket.h>  
int accept(int listenfd, struct sockaddr *addr, int *addrlen);  
Returns: nonnegative connected  
descriptor if OK, -1 on error
```


The `accept` function waits for a connection request from a client to arrive on the listening descriptor `listenfd`, then fills in the client's socket address in `addr`, and returns a *connected descriptor* that can be used to communicate with the client using Unix I/O functions.

The distinction between a listening descriptor and a connected descriptor confuses many students. The listening descriptor serves as an end point for client connection requests. It is typically created once and exists for the lifetime of the server. The connected descriptor is the end point of the connection that is established between the client and the server. It is created each time the server accepts a connection request and exists only as long as it takes the server to service a client.

**Figure 11.14**  outlines the roles of the listening and connected descriptors. In step 1, the server calls `accept`, which waits for a connection request to arrive on the listening descriptor, which for concreteness we will assume is descriptor 3. Recall that descriptors 0–2 are reserved for the standard files.

In step 2, the client calls the `connect` function, which sends a connection request to `listenfd`. In step 3, the `accept` function opens a new connected descriptor `connfd` (which we will assume is descriptor 4), establishes the connection between `clientfd` and `connfd`, and then returns `connfd` to the application. The

## Aside Why the distinction between listening and connected descriptors?

You might wonder why the sockets interface makes a distinction between listening and connected descriptors. At first glance, it appears to be an unnecessary complication. However, distinguishing between the two turns out to be quite useful, because it allows us to build concurrent servers that can process many client connections simultaneously. For example, each time a connection request arrives on the listening descriptor, we might fork a new process that communicates with the client over its connected descriptor. You'll learn more about concurrent servers in [Chapter 12](#) .

client also returns from the `connect`, and from this point, the client and server can pass data back and forth by reading and writing `clientfd` and `connfd`, respectively.

# 11.4.7 Host and Service Conversion

Linux provides some powerful functions, called `getaddrinfo` and `getnameinfo`, for converting back and forth between binary socket address structures and the string representations of hostnames, host addresses, service names, and port numbers. When used in conjunction with the sockets interface, they allow us to write network programs that are independent of any particular version of the IP protocol.

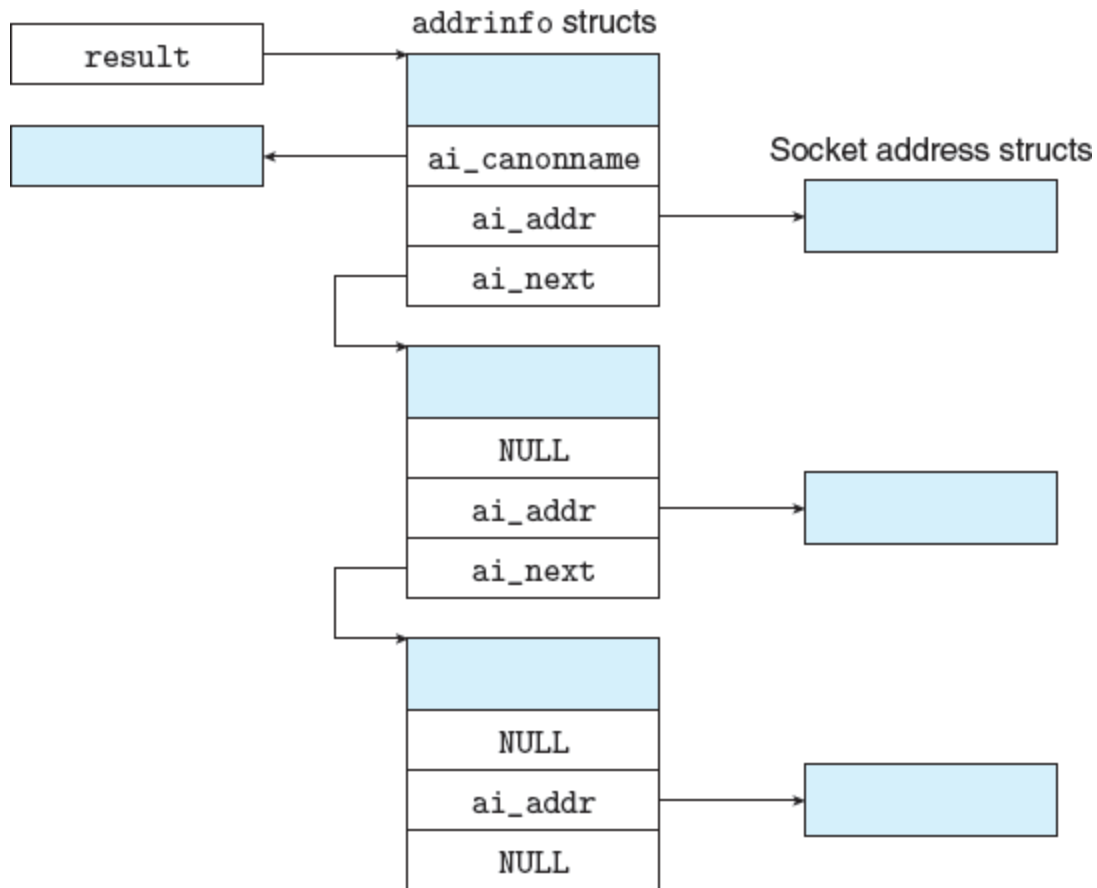
## The `getaddrinfo` Function

The `getaddrinfo` function converts string representations of hostnames, host addresses, service names, and port numbers into socket address structures. It is the modern replacement for the obsolete `gethostbyname` and `getservbyname` functions. Unlike these functions, it is reentrant (see [Section 12.7.2](#)) and works with any protocol.

```
|
#include <sys/types.h>
#include <sys/socket.h>
#include <netdb.h>

int getaddrinfo(const char *host, const char *service,
                const struct addrinfo *hints,
                struct addrinfo **result);
                Returns: 0 if OK,
nonzero error code on error
void freeaddrinfo(struct addrinfo *result);
                Returns: nothing
const char *gai_strerror(int errcode);
                Returns: error message
```






**Figure 11.15** Data structure returned by `getaddrinfo`.

Given `host` and `service` (the two components of a socket address), `getaddrinfo` returns a `result` that points to a linked list of `addrinfo` structures, each of which points to a socket address structure that corresponds to `host` and `service` (Figure 11.15 [□](#)).

After a client calls `getaddrinfo`, it walks this list, trying each socket address in turn until the calls to `socket` and `connect` succeed and the connection is established. Similarly, a server tries each socket address on the list until the calls to `socket` and `bind` succeed and the descriptor is bound to a valid socket address. To avoid memory

leaks, the application must eventually free the list by calling `freeaddrinfo`. If `getaddrinfo` returns a nonzero error code, the application can call `gai_strerror` to convert the code to a message string.

The `host` argument to `getaddrinfo` can be either a domain name or a numeric address (e.g., a dotted-decimal IP address). The `service` argument can be either a service name (e.g., `http`) or a decimal port number. If we are not interested in converting the hostname to an address, we can set `host` to `NULL`. The same holds for `service`. However, at least one of them must be specified.

The optional `hints` argument is an `addrinfo` structure ([Figure 11.16](#) ) that provides finer control over the list of socket addresses that `getaddrinfo` returns. When passed as a `hints` argument, only the `ai_family`, `ai_socktype`, `ai_protocol`, and `ai_flags` fields can be set. The other fields must be set to zero (or `NULL`). In practice, we use `memset` to zero the entire structure and then set a few selected fields:

- By default, `getaddrinfo` can return both IPv4 and IPv6 socket addresses. Setting `ai_family` to `AF_INET` restricts the list to IPv4 addresses. Setting it to `AF_INET6` restricts the list to IPv6 addresses.

```

|
struct addrinfo {
    int          ai_flags;          /* Hints argument
flags */
    int          ai_family;        /* First arg to
socket function */
    int          ai_socktype;      /* Second arg to
socket function */
    int          ai_protocol;     /* Third arg to
socket function */
    char         *ai_canonname;    /* Canonical hostname
*/
    size_t       ai_addrlen;      /* Size of ai_addr
struct */
    struct sockaddr *ai_addr;     /* Ptr to socket
address structure */
    struct addrinfo *ai_next;     /* Ptr to next item
in linked list */
};

```


**Figure 11.16** The `addrinfo` structure used by `getaddrinfo`.

- By default, for each unique address associated with host, the `getaddrinfo` function can return up to three `addrinfo` structures, each with a different `ai_socktype` field: one for connections, one for datagrams (not covered), and one for raw sockets (not covered). Setting `ai_socktype` to `SOCK_STREAM` restricts the list

to at most one `addrinfo` structure for each unique address, one whose socket address can be used as the end point of a connection. This is the desired behavior for all of our example programs.

- The `ai_flags` field is a bit mask that further modifies the default behavior. You create it by ORing combinations of various values. Here are some that we find useful:

`AI_ADDRCONFIG`. This flag is recommended if you are using connections [34]. It asks `getaddrinfo` to return IPv4 addresses only if the local host is configured for IPv4. Similarly for IPv6.

`AI_CANONNAME`. By default, the `ai_canonname` field is NULL. If this flag is set, it instructs `getaddrinfo` to point the `ai_canonname` field in the first `addrinfo` structure in the list to the canonical (official) name of `host` (see [Figure 11.15](#) .

`AI_NUMERICSERV`. By default, the `service` argument can be a service name or a port number. This flag forces the `service` argument to be a port number.

`AI_PASSIVE`. By default, `getaddrinfo` returns socket addresses that can be used by clients as active sockets in calls to `connect`. This flag instructs it to return socket addresses that can be used by servers as listening sockets. In this case, the `host` argument should be NULL. The address field in the resulting socket address structure(s) will be the *wildcard address*, which tells the kernel that this server will

accept requests to any of the IP addresses for this host. This is the desired behavior for all of our example servers.

When `getaddrinfo` creates an `addrinfo` structure in the output list, it fills in each field except for `ai_flags`. The `ai_addr` field points to a socket address structure, the `ai_addrlen` field gives the size of this socket address structure, and the `ai_next` field points to the next `addrinfo` structure in the list. The other fields describe various attributes of the socket address.

One of the elegant aspects of `getaddrinfo` is that the fields in an `addrinfo` structure are opaque, in the sense that they can be passed directly to the functions in the sockets interface without any further manipulation by the application code. For example, `ai_family`, `ai_socktype`, and `ai_protocol` can be passed directly to `socket`. Similarly, `ai_addr` and `ai_addrlen` can be passed directly to `connect` and `bind`. This powerful property allows us to write clients and servers that are independent of any particular version of the IP protocol.

## The `getnameinfo` Function

The `getnameinfo` function is the inverse of `getaddrinfo`. It converts a socket address structure to the corresponding host and service name strings. It is the modern replacement for the obsolete `gethostbyaddr` and `getservbyport` functions, and unlike those functions, it is reentrant and protocol-independent.

```
|  
#include <sys/socket.h>  
#include <netdb.h>  
int getnameinfo(const struct sockaddr *sa, socklen_t salen,  
                char *host, size_t hostlen,  
                char *service, size_t servlen,  
int flags);  
  
Returns: 0 if OK, nonzero error code on error
```

The `sa` argument points to a socket address structure of size `salen` bytes, `host` to a buffer of size `hostlen` bytes, and `service` to a buffer of size `servlen` bytes. The `getnameinfo` function converts the socket address structure `sa` to the corresponding `host` and `service` name strings and copies them to the `host` and `service` buffers. If `getnameinfo` returns a nonzero error code, the application can convert it to a string by calling `gai_strerror`.

If we don't want the hostname, we can `set host` to NULL and `hostlen` to zero. The same holds for the service fields. However, one or the other must be set.

The `flags` argument is a bit mask that modifies the default behavior. You create it by ORing combinations of various values. Here are a couple of useful ones:

`NI_NUMERICHOST`. By default, `getnameinfo` tries to return a domain name in `host`. Setting this flag will cause it to return a numeric address string instead.

`NI_NUMERICSERV`. By default, `getnameinfo` will look in `/etc/services` and if possible, return a service name instead of a port number. Setting this flag forces it to skip the lookup and simply return the port number.

```

1  #include "csapp.h"
2
3  int main(int argc, char **argv)
4  {
5      struct addrinfo *p, *listp, hints;
6      char buf[MAXLINE];
7      int rc, flags;
8
9      if (argc != 2) {
10         fprintf(stderr, "usage: %s <domain
name>\n", argv[0]);
11         exit(0);
12     }
13
14     /* Get a list of addrinfo records */
15     memset(&hints, 0, sizeof(struct addrinfo));
16     hints.ai_family = AF_INET; /* IPv4 only */
17     hints.ai_socktype = SOCK_STREAM; /* Connections
only */
18     if ((rc = getaddrinfo(argv[1], NULL, &hints,
&listp)) != 0) {
19         fprintf(stderr, "getaddrinfo error:
%s\n", gai_strerror(rc));
20         exit(1);
21     }
22
23     /* Walk the list and display each IP address */

```





```

24         flags = NI_NUMERICHOST; /* Display address
string instead of domain name */
25         for (p = listp; p; p = p->ai_next) {
26             Getnameinfo(p->ai_addr, p->ai_addrlen,
buf, MAXLINE, NULL, 0, flags);
27             printf("%s\n", buf);
28         }
29
30         /* Clean up */
31         Freeaddrinfo(listp);
32
33         exit(0);
34     }

```

**Figure 11.17** HOSTINFO displays the mapping of a domain name to its associated IP addresses.

**Figure 11.17**  shows a simple program, called HOSTINFO, that uses `getaddrinfo` and `getnameinfo` to display the mapping of a domain name to its associated IP addresses. It is similar to the NSLOOKUP program from [Section 11.3.2](#) .

First, we initialize the `hints` structure so that `getaddrinfo` returns the addresses we want. In this case, we are looking for 32-bit IP addresses (line 16) that can be used as end points of connections (line 17). Since we are only asking `getaddrinfo` to convert domain names, we call it with a NULL `service` argument.

After the call to `getaddrinfo`, we walk the list of `addrinfo` structures, using `getnameinfo` to convert each socket address to a dotted-decimal address string. After walking the list, we are careful to free it by calling `freeaddrinfo` (although for this simple program it is not strictly necessary).

When we run `HOSTINFO`, we see that `twitter.com` maps to four IP addresses, which is what we saw using `NSLOOKUP` in [Section 11.3.2](#).

```
linux> ./hostinfo twitter.com
199.16.156.102
199.16.156.230
199.16.156.6
199.16.156.70
```

## Practice Problem 11.4 (solution page [968](#))

The `getaddrinfo` and `getnameinfo` functions subsume the functionality of `inet_pton` and `inet_ntop`, respectively, and they provide a higher-level of abstraction that is independent of any particular address format. To convince yourself how handy this is, write a version of `HOSTINFO` ([Figure 11.17](#)) that uses `inet_ntop` instead of `getnameinfo` to convert each socket address to a dotted-decimal address string.

## 11.4.8 Helper Functions for the Sockets Interface


The `getaddrinfo` function and the sockets interface can seem somewhat daunting when you first learn about them. We find it convenient to wrap them with higher-level helper functions, called `open_clientfd` and `open_listenfd`, that clients and servers can use when they want to communicate with each other.

## The `open_clientfd` Function

A client establishes a connection with a server by calling

`open_clientfd`.

```
|  
#include "csapp.h"  
int open_clientfd(char *hostname, char *port);  
Returns: descriptor if OK, -1 on error
```

The `open_clientfd` function establishes a connection with a server running on host `hostname` and listening for connection requests on port number `port`. It returns an open socket descriptor that is ready for input and output using the Unix I/O functions. **Figure 11.18**  shows the code for `open_clientfd`.

We call `getaddrinfo`, which returns a list of `addrinfo` structures, each of which points to a socket address structure that is suitable for establishing a connection

```

1      int open_clientfd(char *hostname, char *port) {
2          int clientfd;
3          struct addrinfo hints, *listp, *p;
4
5          /* Get a list of potential server addresses */
6          memset(&hints, 0, sizeof(struct addrinfo));
7          hints.ai_socktype = SOCK_STREAM; /* Open a
connection */
8          hints.ai_flags = AI_NUMERICSERV; /* ... using a
numeric port arg. */
9          hints.ai_flags |= AI_ADDRCONFIG; /* Recommended
for connections */
10         Getaddrinfo(hostname, port, &hints, &listp);
11
12         /* Walk the list for one that we can
successfully connect to */
13         for (p = listp; p; p = p->ai_next) {
14             /* Create a socket descriptor */
15             if ((clientfd = socket(p->ai_family, p-
>ai_socktype, p->ai_protocol)) < 0)
16                 continue; /* Socket failed, try
the next */
17
18             /* Connect to the server */
19             if (connect(clientfd, p->ai_addr, p-
>ai_addrlen) != -1)
20                 break; /* Success */

```

```

21             Close(clientfd); /* Connect failed, try
another */
22         }
23
24         /* Clean up */
25         Freeaddrinfo(listp);
26         if (!p) /* All connects failed */
27             return -1;
28         else /* The last connect succeeded */
29             return clientfd;
30     }

```

**Figure 11.18** `open_clientfd`: Helper function that establishes a connection with a server.

It is reentrant and protocol-independent.

with a server running on `hostname` and listening on `port`. We then walk the list, trying each list entry in turn, until the calls to `socket` and `connect` succeed. If the `connect` fails, we are careful to close the socket descriptor before trying the next entry. If the `connect` succeeds, we free the list memory and return the socket descriptor to the client, which can immediately begin using Unix I/O to communicate with the server.

Notice how there is no dependence on any particular version of IP anywhere in the code. The arguments to `socket` and `connect` are

generated for us automatically by `getaddrinfo`, which allows our code to be clean and portable.

## The `open_listenfd` Function

A server creates a listening descriptor that is ready to receive connection requests by calling the `open_listenfd` function.

```
|  
#include "csapp.h"  
int open_listenfd(char *port);  
Returns: descriptor if OK, -1 on error
```

The `open_listenfd` function returns a listening descriptor that is ready to receive connection requests on port `port`. [Figure 11.19](#) shows the code for `open_listenfd`.

The style is similar to `open_clientfd`. We call `getaddrinfo` and then walk the resulting list until the calls to `socket` and `bind` succeed. Note that in line 20 we use the `setsockopt` function (not described here) to configure the server so that it can be terminated, be restarted, and begin accepting connection requests immediately. By default, a restarted server will deny connection requests from clients for approximately 30 seconds, which seriously hinders debugging.


Since we have called `getaddrinfo` with the `AI_PASSIVE` flag and a NULL `host` argument, the address field in each socket address structure is set to the wildcard address, which tells the kernel that




this server will accept requests to any of the IP addresses for this host.

Finally, we call the `listen` function to convert `listenfd` to a listening descriptor and return it to the caller. If the `listen` fails, we are careful to avoid a memory leak by closing the descriptor before returning.

## 11.4.9 Example Echo Client and Server

The best way to learn the sockets interface is to study example code. **Figure 11.20**  shows the code for an echo client. After establishing a connection with the server, the client enters a loop that repeatedly reads a text line from standard input, sends the text line to the server, reads the echo line from the server, and prints the result to standard output. The loop terminates when `fgets` encounters EOF on standard input, either because the user typed Ctrl+D at the keyboard or because it has exhausted the text lines in a redirected input file.

After the loop terminates, the client closes the descriptor. This results in an EOF notification being sent to the server, which it detects when it receives a return code of zero from its `rio_readlineb` function. After closing its descriptor, the client terminates. Since the client's kernel automatically closes all open descriptors when a process terminates, the `close` in line 24 is not necessary. However, it is good programming practice to explicitly close any descriptors that you have opened.

**Figure 11.21**  shows the main routine for the echo server. After opening the listening descriptor, it enters an infinite loop. Each iteration waits for a connection request from a client, prints the

domain name and port of the connected client, and then calls the `echo` function that services the client. After the echo routine returns,

```

1      int open_listenfd(char *port)
2      {
3          struct addrinfo hints, *listp, *p;
4          int listenfd, optval=1;
5
6          /* Get a list of potential server addresses */
7          memset(&hints, 0, sizeof(struct addrinfo));
8          hints.ai_socktype = SOCK_STREAM;
/* Accept connections */
9          hints.ai_flags = AI_PASSIVE |
AI_ADDRCONFIG; /* ... on any IP address */
10         hints.ai_flags |= AI_NUMERICSERV;
/* ... using port number */
11         Getaddrinfo(NULL, port, &hints, &listp);
12
13         /* Walk the list for one that we can bind to */
14         for (p = listp; p; p = p->ai_next) {
15             /* Create a socket descriptor */
16             if ((listenfd = socket(p->ai_family, p-
>ai_socktype, p->ai_protocol)) < 0)
17                 continue; /* Socket failed, try
the next */
18
19             /* Eliminates "Address already in use"
error from bind */
20             Setsockopt(listenfd, SOL_SOCKET,
SO_REUSEADDR,

```

```

21             (const void *)&optval ,
sizeof(int));
22
23             /* Bind the descriptor to the address */
24             if (bind(listenfd, p->ai_addr, p-
>ai_addrlen) == 0)
25                 break; /* Success */
26             Close(listenfd); /* Bind failed, try the
next */
27         }
28
29         /* Clean up */
30         Freeaddrinfo(listp);
31         if (!p) /* No address worked */
32             return -1;
33
34         /* Make it a listening socket ready to accept
connection requests */
35         if (listen(listenfd, LISTENQ) < 0) {
36             Close(listenfd);
37             return -1;
38         }
39         return listenfd;
40     }

```

**Figure 11.19** `open_listenfd`: Helper function that opens and returns a listening descriptor.

It is reentrant and protocol-independent.

```
|
1  #include "csapp.h"
2
3  int main(int argc, char **argv)
4  {
5      int clientfd;
6      char *host, *port, buf[MAXLINE];
7      rio_t rio;
8
9      if (argc != 3) {
10         fprintf(stderr, "usage: %s <host>
<port>\n", argv[0]);
11         exit(0);
12     }
13     host = argv[1];
14     port = argv[2];
15
16     clientfd = Open_clientfd(host, port);
17     Rio_readinitb(&rio, clientfd);
18
19     while (Fgets(buf, MAXLINE, stdin) != NULL) {
20         Rio_writen(clientfd, buf, strlen(buf));
21         Rio_readlineb(&rio, buf, MAXLINE);
22         Fputs(buf, stdout);
23     }
24     Close(clientfd);
25     exit(0);
26 }
```

## Figure 11.20 Echo client main routine.

the main routine closes the connected descriptor. Once the client and server have closed their respective descriptors, the connection is terminated.

The `clientaddr` variable in line 9 is a socket address structure that is passed to `accept`. Before `accept` returns, it fills in `clientaddr` with the socket address of the client on the other end of the connection. Notice how we declare `clientaddr` as type struct `sockaddr_storage` rather than struct `sockaddr_in`. By definition, the `sockaddr_storage` structure is large enough to hold any type of socket address, which keeps the code protocol-independent.

Notice that our simple echo server can only handle one client at a time. A server of this type that iterates through clients, one at a time, is called an *iterative server*. In [Chapter 12](#), we will learn how to build more sophisticated *concurrent servers* that can handle multiple clients simultaneously.

Finally, [Figure 11.22](#) shows the code for the `echo` routine, which repeatedly reads and writes lines of text until the `rio_readlineb` function encounters EOF in line 10.

```

1  #include "csapp.h"
2
3  void echo(int connfd);
4
5  int main(int argc, char **argv)
6  {
7      int listenfd, connfd;
8      socklen_t clientlen;
9      struct sockaddr_storage clientaddr; /* Enough
space for any address */
10     char client_hostname[MAXLINE],
client_port[MAXLINE];
11
12     if (argc != 2) {
13         fprintf(stderr, "usage: %s <port>\n",
argv[0]);
14         exit(0);
15     }
16
17     listenfd = Open_listenfd(argv[1]);
18     while (1) {
19         clientlen = sizeof(struct
sockaddr_storage);
20         connfd = Accept(listenfd, (SA
*)&clientaddr, &clientlen);
21         Getnameinfo((SA *) &clientaddr,
clientlen, client_hostname, MAXLINE,

```



```
22         client_port, MAXLINE, 0);
23         printf("Connected to (%s, %s)\n",
client_hostname, client_port);
24         echo(connfd);
25         Close(connfd);
26     }
27     exit(0);
28 }
```

**Figure 11.21** Iterative echo server main routine.

```
|
1  #include "csapp.h"
2
3  void echo(int connfd)
4  {
5      size_t n;
6      char buf[MAXLINE];
7      rio_t rio;
8
9      Rio_readinitb(&rio, connfd);
10     while((n = Rio_readlineb(&rio, buf, MAXLINE)) !=
11     0) {
12         printf("server received %d bytes\n",
13         (int)n);
14         Rio_writen(connfd, buf, n);
15     }
16 }
```

**Figure 11.22** `echo` function that reads and echoes text lines.

## Aside What does EOF on a connection mean?

The idea of EOF is often confusing to students, especially in the context of Internet connections. First, we need to understand that there is no such thing as an EOF character. Rather, EOF is a condition that is detected by the kernel. An application finds out about the EOF condition when it receives a zero return code from the read function. For disk files, EOF occurs when the current file position exceeds the file length. For Internet connections, EOF occurs when a process closes its end of the connection. The process at the other end of the connection detects the EOF when it attempts to read past the last byte in the stream.

## 11.5 Web Servers

So far we have discussed network programming in the context of a simple echo server. In this section, we will show you how to use the basic ideas of network programming to build your own small, but quite functional, Web server.

## 11.5.1 Web Basics

Web clients and servers interact using a text-based application-level protocol known as *HTTP (hypertext transfer protocol)*. HTTP is a simple protocol. A Web client (known as a *browser*) opens an Internet connection to a server and requests some *content*. The server responds with the requested content and then closes the connection. The browser reads the content and displays it on the screen.

What distinguishes Web services from conventional file retrieval services such as FTP? The main difference is that Web content can be written in a language known as *HTML (hypertext markup language)*. An HTML program (page) contains instructions (tags) that tell the browser how to display various text and graphical objects in the page. For example, the code

```
Make me bold!
```

tells the browser to print the text between the **and** tags in boldface type. However, the real power of HTML is that a page can contain pointers (hyperlinks) to content stored on any Internet host. For example, an HTML line of the form

Carnegie Mellon

tells the browser to highlight the text object `Carnegie Mellon` and to create a hyperlink to an HTML file called `index.html` that is stored on the CMU Web server. If the user clicks on the highlighted text object, the browser requests the corresponding HTML file from the CMU server and displays it.

# Aside Origins of the World Wide

## Web

The World Wide Web was invented by Tim Berners-Lee, a software engineer working at CERN, a Swiss physics lab. In 1989, Berners-Lee wrote an internal memo proposing a distributed hypertext system that would connect a "web of notes with links." The intent of the proposed system was to help CERN scientists share and manage information. Over the next two years, after Berners-Lee implemented the first Web server and Web browser, the Web developed a small following within CERN and a few other sites. A pivotal event occurred in 1993, when Marc Andreessen (who later founded Netscape and Andreessen Horowitz) and his colleagues at NCSA released a graphical browser called MOSAIC for all three major platforms: Linux, Windows, and Macintosh. After the release of MOSAIC, interest in the Web exploded, with the number of Web sites increasing at an exponential rate. By 2015, there were over 975,000,000 sites worldwide.

*(Source: Netcraft Web Survey)*

**Figure 11.23 Example MIME types.**



## 11.5.2 Web Content

To Web clients and servers, *content* is a sequence of bytes with an associated *MIME* (*multipurpose internet mail extensions*) type.

**Figure 11.23**  shows some common MIME types.

Web servers provide content to clients in two different ways:

- Fetch a disk file and return its contents to the client. The disk file is known as *static content* and the process of returning the file to the client is known as *serving static content*.
- Run an executable file and return its output to the client. The output produced by the executable at run time is known as *dynamic content*, and the process of running the program and returning its output to the client is known as *serving dynamic content*.

Every piece of content returned by a Web server is associated with some file that it manages. Each of these files has a unique name known as a *URL* (*universal resource locator*). For example, the URL

<http://www.google.com:80/index.html>

identifies an HTML file called `/index.html` on Internet host

[www.google.com](http://www.google.com) that is managed by a Web server listening on port 80. The port number is optional and defaults to the well-known HTTP port 80. URLs for executable files can include program arguments

after the filename. A '?' character separates the filename from the arguments, and each argument is separated by an '&' character. For example, the URL

```
http://bluefish.ics.cs.cmu.edu:8000/cgi-bin/adder?15000&213
```

identifies an executable called `/cgi-bin/adder` that will be called with two argument strings: 15000 and 213. Clients and servers use different parts of the URL during a transaction. For instance, a client uses the prefix

**<http://www.google.com:80>**

to determine what kind of server to contact, where the server is, and what port it is listening on. The server uses the suffix


```
/index.html
```

to find the file on its filesystem and to determine whether the request is for static or dynamic content.

There are several points to understand about how servers interpret the suffix of a URL:

- There are no standard rules for determining whether a URL refers to static or dynamic content. Each server has its own rules for the files it manages. A classic (old-fashioned) approach is to identify a set of directories, such as `cgi-bin`, where all executables must reside.
- The initial ``/` in the suffix does *not* denote the Linux root directory. Rather, it denotes the home directory for whatever kind of content is being requested. For example, a server might be configured so that all static content is stored in directory `/usr/httpd/html` and all dynamic content is stored in directory `/usr/httpd/cgi-bin`.
- The minimal URL suffix is the ``/` character, which all servers expand to some default home page such as `/index.html`. This explains why it is possible to fetch the home page of a site by simply typing a domain name to the browser. The browser appends the missing ``/` to the URL and passes it to the server, which expands the ``/` to some default filename.

## 11.5.3 HTTP Transactions

Since HTTP is based on text lines transmitted over Internet connections, we can use the Linux `TELNET` program to conduct transactions with any Web server on the Internet. The `TELNET` program has been largely supplanted by `SSH` as a remote login tool, but it is very handy for debugging servers that talk to clients with text lines over connections. For example, [Figure 11.24](#)  uses `TELNET` to request the home page from the AOL Web server.

1 linux> telnet www.aol.com 80 **Client: open**  
**connection to server**

2 Trying 205.188.146.23... **Telnet prints 3**  
**lines to the terminal**

3 Connected to aol.com.

4 Escape character is `^]`.

5 GET / HTTP/1.1 **Client: request**  
**line**

6 Host: www.aol.com **Client: required**  
**HTTP/1.1 header**

7 **Client: empty**  
**line terminates headers**

8 HTTP/1.0 200 OK **Server: response**  
**line**

9 MIME-Version: 1.0 **Server: followed**  
**by five response headers**

10 Date: Mon, 8 Jan 2010 4:59:42 GMT

11 Server: Apache-Coyote/1.1

12 Content-Type: text/html **Server: expect**  
**HTML in the response body**

13 Content-Length: 42092 **Server: expect**  
**42,092 bytes in the response body**

14 **Server: empty**  
**line terminates response headers**

15 <html> **Server: first**  
**HTML line in response body**

16 ... **Server: 766**

```
lines of HTML not shown  
17      </html>                                Server: last  
HTML line in response body  
18      Connection closed by foreign host.     Server: closes  
connection  
19      linux>                                  Client: closes  
connection and terminates
```

**Figure 11.24** Example of an HTTP transaction that serves static content.

In line 1, we run `TELNET` from a Linux shell and ask it to open a connection to the AOL Web server. `TELNET` prints three lines of output to the terminal, opens the connection, and then waits for us to enter text (line 5). Each time we enter a text line and hit the `enter` key, `TELNET` reads the line, appends carriage return and line feed characters (`'\r\n'` in C notation), and sends the line to the server. This is consistent with the HTTP standard, which requires every text line to be terminated by a carriage return and line feed pair. To initiate the transaction, we enter an HTTP request (lines 5–7). The server replies with an HTTP response (lines 8–17) and then closes the connection (line 18).

# HTTP Requests

An *HTTP request* consists of a *request line* (line 5), followed by zero or more *request headers* (line 6), followed by an empty text line that terminates the list of headers (line 7). A request line has the form

*method URI version*

HTTP supports a number of different *methods*, including GET, POST, OPTIONS, HEAD, PUT, DELETE, and TRACE. We will only discuss the workhorse GET method, which accounts for a majority of HTTP requests. The GET method instructs the server to generate and return the content identified by the *URI (uniform resource identifier)*. The URI is the suffix of the corresponding URL that includes the filename and optional arguments.<sup>3</sup>

<sup>3</sup>. Actually, this is only true when a browser requests content. If a proxy server requests content, then the URI must be the complete URL.

The *version* field in the request line indicates the HTTP version to which the request conforms. The most recent HTTP version is HTTP/1.1 [37]. HTTP/1.0 is an earlier, much simpler version from 1996 [6]. HTTP/1.1 defines additional headers that provide support for advanced features such as caching and security, as well as a mechanism that allows a client and server to perform multiple transactions over the same *persistent connection*. In practice, the two versions are compatible because HTTP/1.0 clients and servers simply ignore unknown HTTP/1.1 headers.

To summarize, the request line in line 5 asks the server to fetch and return the HTML file `/index.html`. It also informs the server that the remainder of the request will be in HTTP/1.1 format.

Request headers provide additional information to the server, such as the brand name of the browser or the MIME types that the browser understands. Request headers have the form

*header-name: header-data*

For our purposes, the only header to be concerned with is the `Host` header (line 6), which is required in HTTP/1.1 requests, but not in HTTP/1.0 requests. The `Host` header is used by *proxy caches*, which sometimes serve as intermediaries between a browser and the *origin server* that manages the requested file. Multiple proxies can exist between a client and an origin server in a so-called proxy chain. The data in the `Host` header, which identifies the domain name of the origin server, allow a proxy in the middle of a proxy chain to determine if it might have a locally cached copy of the requested content.

Continuing with our example in [Figure 11.24](#), the empty text line in line 7 (generated by hitting `enter` on our keyboard) terminates the headers and instructs the server to send the requested HTML file.



# HTTP Responses

HTTP responses are similar to HTTP requests. An *HTTP response* consists of a *response line* (line 8), followed by zero or more *response headers* (lines 9–13), followed by an empty line that terminates the headers (line 14), followed by the *response body* (lines 15–17). A response line has the form

*version status-code status-message*

The *version* field describes the HTTP version that the response conforms to. The *status-code* is a three-digit positive integer that indicates the disposition of the request. The *status-message* gives the English equivalent of the error code. [Figure 11.25](#) lists some common status codes and their corresponding messages.

## Aside Passing arguments in HTTP

### POST requests

Arguments for HTTP POST requests are passed in the request body rather than in the URI.

## Figure 11.25 Some HTTP status codes.

The response headers in lines 9–13 provide additional information about the response. For our purposes, the two most important headers are `Content-Type` (line 12), which tells the client the MIME type of the content in the response body, and `Content-Length` (line 13), which indicates its size in bytes.

The empty text line in line 14 that terminates the response headers is followed by the response body, which contains the requested content.

## 11.5.4 Serving Dynamic Content

If we stop to think for a moment how a server might provide dynamic content to a client, certain questions arise. For example, how does the client pass any program arguments to the server? How does the server pass these arguments to the child process that it creates? How does the server pass other information to the child that it might need to generate the content? Where does the child send its output? These questions are addressed by a de facto standard called *CGI (common gateway interface)*.

### *How Does the Client Pass Program Arguments to the Server?*

Arguments for GET requests are passed in the URI. As we have seen, a '?' character separates the filename from the arguments, and each argument is separated by an '&' character. Spaces are not allowed in arguments and must be represented with the '%20' string. Similar encodings exist for other special characters.

## How Does the Server Pass Arguments to the Child?


After a server receives a request such as

```
GET /cgi-bin/adder?15000&213 HTTP/1.1
```

**Figure 11.26** Examples of CGI environment variables.

it calls `fork` to create a child process and calls `execve` to run the `/cgi-bin/adder` program in the context of the child. Programs like the `adder` program are often referred to as *CGI programs* because they obey the rules of the CGI standard. Before the call to `execve`, the child process sets the CGI environment variable `QUERY_STRING` to `15000&213`, which the `adder` program can reference at run time using the Linux `getenv` function.


## How Does the Server Pass Other Information to the Child?


CGI defines a number of other environment variables that a CGI program can expect to be set when it runs. [Figure 11.26](#)  shows a subset.

## *Where Does the Child Send Its Output?*



A CGI program sends its dynamic content to the standard output. Before the child process loads and runs the CGI program, it uses the Linux `dup2` function to redirect standard output to the connected descriptor that is associated with the client. Thus, anything that the CGI program writes to standard output goes directly to the client.

Notice that since the parent does not know the type or size of the content that the child generates, the child is responsible for generating the `Content-type` and `Content-length` response headers, as well as the empty line that terminates the headers.

**Figure 11.27**  shows a simple CGI program that sums its two arguments and returns an HTML file with the result to the client.

**Figure 11.28**  shows an HTTP transaction that serves dynamic content from the `adder` program.

### Practice Problem 11.5 (solution page **969**)

In **Section 10.11** , we warned you about the dangers of using the C standard I/O functions in network applications. Yet the CGI program in **Figure 11.27**  is able to use standard I/O without any problems. Why?

## Aside Passing arguments in HTTP

### POST requests to CGI programs

For POST requests, the child would also need to redirect standard input to the connected descriptor. The CGI program would then read the arguments in the request body from standard input.

```

1  #include "csapp.h"
2
3  int main(void) {
4      char *buf, *p;
5      char arg1[MAXLINE], arg2[MAXLINE],
content[MAXLINE];
6      int n1=0, n2=0;
7
8      /* Extract the two arguments */
9      if ((buf = getenv("QUERY_STRING")) != NULL) {
10         p = strchr(buf, '&');
11         *p = '\0';
12         strcpy(arg1, buf);
13         strcpy(arg2, p+1);
14         n1 = atoi(arg1);
15         n2 = atoi(arg2);
16     }
17
18     /* Make the response body */
19     sprintf(content, "QUERY_STRING=%s", buf);
20     sprintf(content, "Welcome to add.com: ");
21     sprintf(content, "%sTHE Internet addition
portal.\r\n<p>", content);
22     sprintf(content, "%sThe answer is: %d + %d =
%d\r\n<p>",
23         content, n1, n2, n1 + n2);
24     sprintf(content, "%sThanks for visiting!\r\n",

```

```
content);  
25  
26          /* Generate the HTTP response */  
27          printf("Connection: close\r\n");  
28          printf("Content-length: %d\r\n",  
(int)strlen(content));  
29          printf("Content-type: text/html\r\n\r\n");  
30          printf("%s", content);  
31          fflush(stdout);  
32  
33          exit(0);  
34      }
```

**Figure 11.27** CGI program that sums two integers.



```
1      linux> telnet kittyhawk.cmcl.cs.cmu.edu 8000      Client:
open connection
2      Trying 128.2.194.242...
3      Connected to kittyhawk.cmcl.cs.cmu.edu.
4      Escape character is `^_`.
5      GET /cgi-bin/adder?15000&213 HTTP/1.0
Client: request line
6
Client: empty line terminates headers
7      HTTP/1.0 200 OK
Server: response line
8      Server: Tiny Web Server
Server: identify server
9      Content-length: 115
Adder: expect 115 bytes in response body
10     Content-type: text/html
Adder: expect HTML in response body
11
Adder: empty line terminates headers
12     Welcome to add.com: THE Internet addition portal.
Adder: first HTML line
13     <p>The answer is: 15000 + 213 = 15213
Adder: second HTML line in response body
14     <p>Thanks for visiting!
Adder: third HTML line in response body
15     Connection closed by foreign host.
Server: closes connection
```

```
16      linux>
```

```
Client: closes connection and terminates
```


**Figure 11.28** An HTTP transaction that serves dynamic HTML content.

[OceanofPDF.com](http://OceanofPDF.com)



## 11.6 Putting It Together: The TINY Web Server

We conclude our discussion of network programming by developing a small but functioning Web server called TINY. TINY is an interesting program. It combines many of the ideas that we have learned about, such as process control, Unix I/O, the sockets interface, and HTTP, in only 250 lines of code. While it lacks the functionality, robustness, and security of a real server, it is powerful enough to serve both static and dynamic content to real Web browsers. We encourage you to study it and implement it yourself. It is quite exciting (even for the authors!) to point a real browser at your own server and watch it display a complicated Web page with text and graphics.

## The TINY `main` Routine

**Figure 11.29**  shows TINY's main routine. TINY is an iterative server that listens for connection requests on the port that is passed in the command line. After opening a listening socket by calling the `open_listenfd` function, TINY executes the typical infinite server loop, repeatedly accepting a connection request (line 32), performing a transaction (line 36), and closing its end of the connection (line 37).

## The `doit` Function

The `doit` function in [Figure 11.30](#)  handles one HTTP transaction. First, we read and parse the request line (lines 11–14). Notice that we are using the `rio_readlineb` function from [Figure 10.8](#)  to read the request line.

TINY supports only the GET method. If the client requests another method (such as POST), we send it an error message and return to the main routine

```

1      /*
2      * tiny.c - A simple, iterative HTTP/1.0 Web server that
uses the
3      * GET method to serve static and dynamic content
4      */
5      #include "csapp.h"
6
7      void doit(int fd);
8      void read_requesthdrs(rio_t *rp);
9      int parse_uri(char *uri, char *filename, char *cgiargs);
10     void serve_static(int fd, char *filename, int filesize);
11     void get_filetype(char *filename, char *filetype);
12     void serve_dynamic(int fd, char *filename, char
*cgiargs);
13     void clienterror(int fd, char *cause, char *errnum,
14     char *shortmsg, char *longmsg);
15
16     int main(int argc, char **argv)
17     {
18         int listenfd, connfd;
19         char hostname[MAXLINE], port[MAXLINE];
20         socklen_t clientlen;
21         struct sockaddr_storage clientaddr;
22
23         /* Check command-line args */
24         if (argc != 2) {
25             fprintf(stderr, "usage: %s <port>\n", argv[0]);

```

```
26     exit(1);
27 }
28
29     listenfd = Open_listenfd(argv[1]);
30     while (1) {
31         clientlen = sizeof(clientaddr);
32         connfd = Accept(listenfd, (SA *)&clientaddr,
&clientlen);
33         Getnameinfo((SA *) &clientaddr, clientlen, hostname,
MAXLINE,
34         port, MAXLINE, 0);
35         printf("Accepted connection from (%s, %s)\n", hostname,
port);
36         doit(connfd);
37         Close(connfd);
38     }
39 }
```

**Figure 11.29** The TINY Web server.

```
|
1 void doit(int fd)
2 {
3     int is_static;
4     struct stat sbuf;
5     char buf[MAXLINE], method[MAXLINE], uri[MAXLINE],
version[MAXLINE];
6     char filename[MAXLINE], cgiargs[MAXLINE];
7     rio_t rio;
8
9     /* Read request line and headers */
10    Rio_readinitb(&rio, fd);
11    Rio_readlineb(&rio, buf, MAXLINE);
12    printf("Request headers:\n");
13    printf("%s", buf);
14    sscanf(buf, "%s %s %s", method, uri, version);
15    if (strcasecmp(method, "GET")) {
16        clienterror(fd, method, "501", "Not implemented",
17            "Tiny does not implement this method");
18    }
19    return;
20    read_requesthdrs(&rio);
21
22    /* Parse URI from GET request */
23    is_static = parse_uri(uri, filename, cgiargs);
24    if (stat(filename, &sbuf) < 0) {
25        clienterror(fd, filename, "404", "Not found",
26            "Tiny couldn't find this file");
```



```

27     return;
28 }
29
30     if (is_static) { /* Serve static content */
31         if (!(S_ISREG(sbuf.st_mode) |          |          | !(S_IRUSR &
sbuf.st_mode)) {
32             clienterror(fd, filename, "403", "Forbidden",
33                 "Tiny couldn't read the file");
34             return;
35         }
36         serve_static(fd, filename, sbuf.st_size);
37     }
38     else { /* Serve dynamic content */
39         if (!(S_ISREG(sbuf.st_mode) |          |          | !(S_IXUSR &
sbuf.st_mode)) {
40             clienterror(fd, filename, "403", "Forbidden",
41                 "Tiny couldn't run the CGI program");
42             return;
43         }
44         serve_dynamic(fd, filename, cgiargs);
45     }
46 }

```


**Figure 11.30** `TINY do_it` handles one HTTP transaction.

(lines 15–19), which then closes the connection and awaits the next connection request. Otherwise, we read and (as we shall see) ignore any request headers (line 20).

Next, we parse the URI into a filename and a possibly empty CGI argument string, and we set a flag that indicates whether the request is for static or dynamic content (line 23). If the file does not exist on disk, we immediately send an error message to the client and return.

Finally, if the request is for static content, we verify that the file is a regular file and that we have read permission (line 31). If so, we serve the static content (line 36) to the client. Similarly, if the request is for dynamic content, we verify that the file is executable (line 39), and, if so, we go ahead and serve the dynamic content (line 44).

## The `clienterror` Function

TINY lacks many of the error-handling features of a real server. However, it does check for some obvious errors and reports them to the client. The `clienterror` function in [Figure 11.31](#)  sends an HTTP response to the client with the appropriate

```

1 void clienterror(int fd, char *cause, char *errnum,
2                 char *shortmsg, char *longmsg)
3 {
4     char buf[MAXLINE], body[MAXBUF];
5
6     /* Build the HTTP response body */
7     sprintf(body, "<html><title>Tiny
Error</title>");
8     sprintf(body, "%s<body bgcolor=""ffffff"">\r\n",
body);
9     sprintf(body, "%s%s: %s\r\n", body, errnum,
shortmsg);
10    sprintf(body, "%s<p>%s: %s\r\n", body, longmsg,
cause);
11    sprintf(body, "%s<hr><em>The Tiny Web
server</em>\r\n", body);
12
13    /* Print the HTTP response */
14    sprintf(buf, "HTTP/1.0 %s %s\r\n", errnum,
shortmsg);
15    Rio_writen(fd, buf, strlen(buf));
16    sprintf(buf, "Content-type: text/html\r\n");
17    Rio_writen(fd, buf, strlen(buf));
18    sprintf(buf, "Content-length: %d\r\n\r\n",
(int)strlen(body));
19    Rio_writen(fd, buf, strlen(buf));

```

```
20         Rio_writen(fd, body, strlen(body));
21     }
```

**Figure 11.31** TINY clienterror sends an error message to the client.

```
|
1     void read_requesthdrs(rio_t *rp)
2     {
3         char buf[MAXLINE];
4
5         Rio_readlineb(rp, buf, MAXLINE);
6         while(strcmp(buf, "\r\n")) {
7             Rio_readlineb(rp, buf, MAXLINE);
8             printf("%s", buf);
9         }
10        return;
11    }
```

**Figure 11.32** TINY read\_requesthdrs reads and ignores request headers.

status code and status message in the response line, along with an HTML file in the response body that explains the error to the browser's user.


Recall that an HTML response should indicate the size and type of the content in the body. Thus, we have opted to build the HTML content as a single string so that we can easily determine its size. Also, notice that we are using the robust `rio_writen` function from [Figure 10.4](#) for all output.

## *The `read_requesthdrs` Function*

TINY does not use any of the information in the request headers. It simply reads and ignores them by calling the `read_requesthdrs` function in [Figure 11.32](#). Notice that the empty text line that terminates the request headers consists of a carriage return and line feed pair, which we check for in line 6.

## The `parse_uri` Function

TINY assumes that the home directory for static content is its current directory and that the home directory for executables is `./cgi-bin`. Any URI that contains the string `cgi-bin` is assumed to denote a request for dynamic content. The default filename is `./home.html`.

The `parse_uri` function in [Figure 11.33](#)  implements these policies. It parses the URI into a filename and an optional CGI argument string. If the request is for static content (line 5), we clear the CGI argument string (line 6) and then convert the URI into a relative Linux pathname such as `./index.html` (lines 7–8). If the URI ends with a `'` character (line 9), then we append the default filename (line 10). On the other hand, if the request is for dynamic content (line 13), we extract any CGI arguments (lines 14–20) and convert the remaining portion of the URI to a relative Linux filename (lines 21–22).

```
1     int parse_uri(char *uri, char *filename, char *cgiargs)
2     {
3         char *ptr;
4
5         if (!strstr(uri, "cgi-bin")) { /* Static content
*/
6             strcpy(cgiargs, "");
7             strcpy(filename, ".");
8             strcat(filename, uri);
9             if (uri[strlen(uri)-1] == '/')
10                strcat(filename, "home.html");
11            return 1;
12        }
13        else { /* Dynamic content */
14            ptr = index(uri, '?');
15            if (ptr) {
16                strcpy(cgiargs, ptr+1);
17                *ptr = '\0';
18            }
19            else
20                strcpy(cgiargs, "");
21            strcpy(filename, ".");
22            strcat(filename, uri);
23            return 0;
24        }
25    }
```



**Figure 11.33** TINY parse\_uri parses an HTTP URI.

## The `serve_static` Function

TINY serves five common types of static content: HTML files, unformatted text files, and images encoded in GIF, PNG, and JPEG formats.

The `serve_static` function in [Figure 11.34](#) sends an HTTP response whose body contains the contents of a local file. First, we determine the file type by inspecting the suffix in the filename (line 7) and then send the response line and response headers to the client (lines 8–13). Notice that a blank line terminates the headers.

Next, we send the response body by copying the contents of the requested file to the connected descriptor `fd`. The code here is somewhat subtle and needs to be studied carefully. Line 18 opens `filename` for reading and gets its descriptor. In line 19, the Linux `mmap` function maps the requested file to a virtual memory area. Recall from our discussion of `mmap` in [Section 9.8](#) that the call to `mmap` maps the

```

1 void serve_static(int fd, char *filename, int filesize)
2 {
3     int srcfd;
4     char *srcp, filetype[MAXLINE], buf[MAXBUF];
5
6     /* Send response headers to client */
7     get_filetype(filename, filetype);
8     sprintf(buf, "HTTP/1.0 200 OK\r\n");
9     sprintf(buf, "%sServer: Tiny Web Server\r\n",
buf);
10    sprintf(buf, "%sConnection: close\r\n", buf);
11    sprintf(buf, "%sContent-length: %d\r\n", buf,
filesize);
12    sprintf(buf, "%sContent-type: %s\r\n\r\n", buf,
filetype);
13    Rio_writen(fd, buf, strlen(buf));
14    printf("Response headers:\n");
15    printf("%s", buf);
16
17    /* Send response body to client */
18    srcfd = Open(filename, O_RDONLY, 0);
19    srcp = Mmap(0, filesize, PROT_READ, MAP_PRIVATE,
srcfd, 0);
20    Close(srcfd);
21    Rio_writen(fd, srcp, filesize);
22    Munmap(srcp, filesize);
23 }

```

```

24
25  /*
26   * get_filetype - Derive file type from filename
27   */
28   void get_filetype(char *filename, char *filetype)
29   {
30       if (strstr(filename, ".html"))
31           strcpy(filetype, "text/html");
32       else if (strstr(filename, ".gif"))
33           strcpy(filetype, "image/gif");
34       else if (strstr(filename, ".png"))
35           strcpy(filetype, "image/png");
36       else if (strstr(filename, ".jpg"))
37           strcpy(filetype, "image/jpeg");
38       else
39           strcpy(filetype, "text/plain");
40   }

```

**Figure 11.34** TINY `serve_static` serves static content to a client.


first `filesize` bytes of file `srcfd` to a private read-only area of virtual memory that starts at address `srcp`.

Once we have mapped the file to memory, we no longer need its descriptor, so we close the file (line 20). Failing to do this would introduce a potentially fatal memory leak. Line 21 performs the actual transfer of the file to the client. The `rio_writen` function copies

the `filesize` bytes starting at location `srcp` (which of course is mapped to the requested file) to the client's connected descriptor. Finally, line 22 frees the mapped virtual memory area. This is important to avoid a potentially fatal memory leak.

## The `serve_dynamic` Function

TINY serves any type of dynamic content by forking a child process and then running a CGI program in the context of the child.

The `serve_dynamic` function in [Figure 11.35](#)  begins by sending a response line indicating success to the client, along with an informational `Server` header. The CGI program is responsible for sending the rest of the response. Notice that this is not as robust as we might wish, since it doesn't allow for the possibility that the CGI program might encounter some error.

After sending the first part of the response, we fork a new child process (line 11). The child initializes the `QUERY_STRING` environment variable with the CGI arguments from the request URI (line 13). Notice that a real server would

```

1 void serve_dynamic(int fd, char *filename, char
*cgiargs)
2 {
3     char buf[MAXLINE], *emptylist[] = { NULL };
4
5     /* Return first part of HTTP response */
6     sprintf(buf, "HTTP/1.0 200 OK\r\n");
7     Rio_writen(fd, buf, strlen(buf));
8     sprintf(buf, "Server: Tiny Web Server\r\n");
9     Rio_writen(fd, buf, strlen(buf));
10
11     if (Fork() == 0) { /* Child */
12         /* Real server would set all CGI vars
here */
13         setenv("QUERY_STRING", cgiargs, 1);
14         Dup2(fd, STDOUT_FILENO); /* Redirect
stdout to client */
15         Execve(filename, emptylist, environ); /*
Run CGI program */
16     }
17     Wait(NULL); /* Parent waits for and reaps child
*/
18 }

```

**Figure 11.35** TINY `serve_dynamic` serves dynamic content to a client.

## Aside Dealing with prematurely closed connections

Although the basic functions of a Web server are quite simple, we don't want to give you the false impression that writing a real Web server is easy. Building a robust Web server that runs for extended periods without crashing is a difficult task that requires a deeper understanding of Linux systems programming than we've learned here. For example, if a server writes to a connection that has already been closed by the client (say, because you clicked the "Stop" button on your browser), then the first such write returns normally, but the second write causes the delivery of a SIGPIPE signal whose default behavior is to terminate the process. If the SIGPIPE signal is caught or ignored, then the second write operation returns `-1` with `errno` set to `EPIPE`. The `strerr` and `perror` functions report the `EPIPE` error as a "Broken pipe," a nonintuitive message that has confused generations of students. The bottom line is that a robust server must catch these SIGPIPE signals and check `write` function calls for `EPIPE` errors.

set the other CGI environment variables here as well. For brevity, we have omitted this step.

Next, the child redirects the child's standard output to the connected file descriptor (line 14) and then loads and runs the CGI program (line 15). Since the CGI program runs in the context of the child, it



has access to the same open files and environment variables that existed before the call to the `execve` function. Thus, everything that the CGI program writes to standard output goes directly to the client process, without any intervention from the parent process. Meanwhile, the parent blocks in a call to `wait`, waiting to reap the child when it terminates (line 17).

[OceanofPDF.com](http://OceanofPDF.com)

## 11.7 Summary

Every network application is based on the client-server model. With this model, an application consists of a server and one or more clients. The server manages resources, providing a service for its clients by manipulating the resources in some way. The basic operation in the client-server model is a client-server transaction, which consists of a request from a client, followed by a response from the server.

Clients and servers communicate over a global network known as the Internet. From a programmer's point of view, we can think of the Internet as a worldwide collection of hosts with the following properties: (1) Each Internet host has a unique 32-bit name called its IP address. (2) The set of IP addresses is mapped to a set of Internet domain names. (3) Processes on different Internet hosts can communicate with each other over connections.

Clients and servers establish connections by using the sockets interface. A socket is an end point of a connection that is presented to applications in the form of a file descriptor. The sockets interface provides functions for opening and closing socket descriptors. Clients and servers communicate with each other by reading and writing these descriptors.

Web servers and their clients (such as browsers) communicate with each other using the HTTP protocol. A browser requests either static or dynamic content from the server. A request for static content is served by fetching a file from the server's disk and returning it to the client. A request for dynamic content is served by running a program in the context of a child process on the server and returning its output to the client. The CGI standard provides a set of rules that govern how the client passes program arguments to the server, how the server passes these arguments and other information to the child process, and how the child sends its output back to the client. A simple but functioning Web server that serves both static and dynamic content can be implemented in a few hundred lines of C code.

[OceanofPDF.com](http://OceanofPDF.com)

# Bibliographic Notes

The official source of information for the Internet is contained in a set of freely available numbered documents known as *RFCs* (*requests for comments*). A searchable index of RFCs is available on the Web at

<http://rfc-editor.org>

RFCs are typically written for developers of Internet infrastructure, and thus they are usually too detailed for the casual reader. However, for authoritative information, there is no better source. The HTTP/1.1 protocol is documented in RFC 2616. The authoritative list of MIME types is maintained at

<http://www.iana.org/assignments/media-types>

Kerrisk is the bible for all aspects of Linux programming and provides a detailed discussion of modern network programming [62]. There are a number of good general texts on computer networking [65, 84, 114]. The great technical writer W. Richard Stevens developed a series of classic texts on such topics as advanced Unix programming [111], the Internet protocols [109, 120, 107], and Unix network programming [108, 110]. Serious students of Unix systems

programming will want to study all of them. Tragically, Stevens died on September 1, 1999. His contributions are greatly missed.

[OceanofPDF.com](http://OceanofPDF.com)

# Homework Problems

## 11.6

Modify TINY so that it echoes every request line and request header.

Use your favorite browser to make a request to TINY for static content. Capture the output from TINY in a file.

Inspect the output from TINY to determine the version of HTTP your browser uses.

Consult the HTTP/1.1 standard in RFC 2616 to determine the meaning of each header in the HTTP request from your browser. You can obtain RFC 2616 from [www.rfc-editor.org/rfc.html](http://www.rfc-editor.org/rfc.html).

## 11.7

Extend TINY so that it serves MPG video files. Check your work using a real browser.


## 11.8

Modify TINY so that it reaps CGI children inside a SIGCHLD handler instead of explicitly waiting for them to terminate.

## 11.9

Modify TINY so that when it serves static content, it copies the requested file to the connected descriptor using `malloc`, `rio_readn`, and `rio_writen`, instead of `mmap` and `rio_writen`.

## 11.10

- A. Write an HTML form for the CGI `adder` function in **Figure 11.27** . Your form should include two text boxes that users fill in with the two numbers to be added together. Your form should request content using the GET method.
- B. Check your work by using a real browser to request the form from TINY, submit the filled-in form to TINY, and then display the dynamic content generated by `adder`.

## 11.11

Extend T<sub>INY</sub> to support the HTTP HEAD method. Check your work using TELNET as a Web client.

## 11.12

Extend T<sub>INY</sub> so that it serves dynamic content requested by the HTTP POST method. Check your work using your favorite Web browser.

## 11.13

Modify T<sub>INY</sub> so that it deals cleanly (without terminating) with the SIGPIPE signals and EPIPE errors that occur when the write function attempts to write to a prematurely closed connection.



# Solutions to Practice Problems

## **Solution to Problem 11.1** (page 927)

# **Solution to Problem 11.2** (page 927)

```
|
1  #include "csapp.h"
2
3  int main(int argc, char **argv)
4  {
5      struct in_addr inaddr; /* Address in network
byte order */
6      uint32_t addr; /* Address in host byte
order */
7      char buf[MAXBUF]; /* Buffer for dotted-
decimal string */
8
9      if (argc != 2) {
10         fprintf(stderr, "usage: %s <hex
number>\n", argv[0]);
11         exit(0);
12     }
13     sscanf(argv[1], "%x", &addr);
14     inaddr.s_addr = htonl(addr);
15
16     if (!inet_ntop(AF_INET, &inaddr, buf, MAXBUF))
17         unix_error("inet_ntop");
18     printf("%s\n", buf); 19
20     exit(0);
21 }
```

# **Solution to Problem 11.3** (page 927)

```
|
1  #include "csapp.h"
2
3  int main(int argc, char **argv)
4  {
5      struct in_addr inaddr; /* Address in network
byte order */
6      int rc;
7
8      if (argc != 2) {
9          fprintf(stderr, "usage: %s <dotted-
decimal>\n", argv[0]);
10         exit(0);
11     }
12
13     rc = inet_pton(AF_INET, argv[1], &inaddr);
14     if (rc == 0)
15         app_error("inet_pton error: invalid
dotted-decimal address");
16     else if (rc < 0)
17         unix_error("inet_pton error");
18
19     printf("0x%x\n", ntohl(inaddr.s_addr));
20     exit(0);
21 }
```

# Solution to Problem 11.4 [↗](#)(page 942)

Here's a solution. Notice how much more difficult it is to use `inet_ntop`, which requires messy casting and deep structure references. The `getnameinfo` function is much simpler because it does all of that work for us.

```
|
1  #include "csapp.h"
2
3  int main(int argc, char **argv)
4  {
5      struct addrinfo *p, *listp, hints;
6      struct sockaddr_in *sockp;
7      char buf[MAXLINE];
8      int rc;
9
10     if (argc != 2) {
11         fprintf(stderr, "usage: %s <domain
name>\n", argv[0]);
12         exit(0);
13     }
14
15     /* Get a list of addrinfo records */
16     memset(&hints, 0, sizeof(struct addrinfo));
17     hints.ai_family = AF_INET; /* IPv4 only */
18     hints.ai_socktype = SOCK_STREAM; /* Connections
only */
19     if ((rc = getaddrinfo(argv[1], NULL, &hints,
&listp)) != 0) {
20         fprintf(stderr, "getaddrinfo error:
%s\n", gai_strerror(rc));
21         exit(1);
22     }
23
```

```

24          /* Walk the list and display each associated IP
address */
25          for (p = listp; p; p = p->ai_next) {
26              sockp = (struct sockaddr_in *)p-
>ai_addr;
27              Inet_ntop(AF_INET, &(sockp->sin_addr),
buf, MAXLINE);
28              printf("%s\n", buf);
29          }
30
31          /* Clean up */
32          Freeaddrinfo(listp);
33
34          exit(0);
35      }

```

## Solution to Problem 11.5 (page 954)

The reason that standard I/O works in CGI programs is that the CGI program running in the child process does not need to explicitly close any of its input or output streams. When the child terminates, the kernel closes all descriptors automatically.



---

# Chapter **12** Concurrent Programming

---

**12.1 Concurrent Programming with Processes 973** 

**12.2 Concurrent Programming with I/O Multiplexing 977** 

**12.3 Concurrent Programming with Threads 985** 

**12.4 Shared Variables in Threaded Programs 992** 

**12.5 Synchronizing Threads with Semaphores 995** 

**12.6 Using Threads for Parallelism 1013** 

**12.7 Other Concurrency Issues 1020** 

**12.8 Summary 1030** 

**Bibliographic Notes 1030** 

**Homework Problems 1031** 

**Solutions to Practice Problems 1036** 

As we learned in [Chapter 8](#), logical control flows are concurrent if they overlap in time. This general phenomenon, known as concurrency, shows up at many different levels of a computer system. Hardware exception handlers, processes, and Linux signal handlers are all familiar examples.

Thus far, we have treated concurrency mainly as a mechanism that the operating system kernel uses to run multiple application programs. But concurrency is not just limited to the kernel. It can play an important role in application programs as well. For example, we have seen how Linux signal handlers allow applications to respond to asynchronous events such as the user typing Ctrl+C or the program accessing an undefined area of virtual memory. Application-level concurrency is useful in other ways as well:

- **Accessing slow I/O devices.** When an application is waiting for data to arrive from a slow I/O device such as a disk, the kernel keeps the CPU busy by running other processes. Individual applications can exploit concurrency in a similar way by overlapping useful work with I/O requests.

- **Interacting with humans.** People who interact with computers demand the ability to perform multiple tasks at the same time. For example, they might want to resize a window while they are printing a document. Modern windowing systems use concurrency to provide this capability. Each time the user requests some action (say, by clicking the mouse), a separate concurrent logical flow is created to perform the action.
- **Reducing latency by deferring work.** Sometimes, applications can use concurrency to reduce the latency of certain operations by deferring other operations and performing them concurrently. For example, a dynamic storage allocator might reduce the latency of individual free operations by deferring coalescing to a concurrent "coalescing" flow that runs at a lower priority, soaking up spare CPU cycles as they become available.
- **Servicing multiple network clients.** The iterative network servers that we studied in [Chapter 11](#) are unrealistic because they can only service one client at a time. Thus, a single slow client can deny service to every other client. For a real server that might be expected to service hundreds or thousands

*of clients per second, it is not acceptable to allow one slow client to deny service to the others. A better approach is to build a concurrent server that creates a separate logical flow for each client. This allows the server to service multiple clients concurrently and precludes slow clients from monopolizing the server.*


- **Computing in parallel on multi-core machines.** *Many modern systems are equipped with multi-core processors that contain multiple CPUs. Applications that are partitioned into concurrent flows often run faster on multi-core machines than on uniprocessor machines because the flows execute in parallel rather than being interleaved.*

*Applications that use application-level concurrency are known as concurrent programs. Modern operating systems provide three basic approaches for building concurrent programs:*

- **Processes.** *With this approach, each logical control flow is a process that is scheduled and maintained by the kernel. Since processes have separate virtual address*

spaces, flows that want to communicate with each other must use some kind of explicit interprocess communication (IPC) mechanism.



- **I/O multiplexing.** This is a form of concurrent programming where applications explicitly schedule their own logical flows in the context of a single process. Logical flows are modeled as state machines that the main program explicitly transitions from state to state as a result of data arriving on file descriptors. Since the program is a single process, all flows share the same address space.
- **Threads.** Threads are logical flows that run in the context of a single process and are scheduled by the kernel. You can think of threads as a hybrid of the other two approaches, scheduled by the kernel like process flows and sharing the same virtual address space like I/O multiplexing flows.

This chapter investigates these three different concurrent programming techniques. To keep our discussion concrete, we will work with the same motivating application throughout—a concurrent version of the iterative echo server from [Section 11.4.9](#) .

[OceanofPDF.com](http://OceanofPDF.com)

# 12.1 Concurrent Programming with Processes

The simplest way to build a concurrent program is with processes, using familiar functions such as `fork`, `exec`, and `waitpid`. For example, a natural approach for building a concurrent server is to accept client connection requests in the parent and then create a new child process to service each new client.

To see how this might work, suppose we have two clients and a server that is listening for connection requests on a listening descriptor (say, 3). Now suppose that the server accepts a connection request from client 1 and returns a connected descriptor (say, 4), as shown in [Figure 12.1](#) . After accepting the connection request, the server forks a child, which gets a complete copy of the server's descriptor table. The child closes its copy of listening descriptor 3, and the parent closes its copy of connected descriptor 4, since they are no longer needed. This gives us the situation shown in [Figure 12.2](#) , where the child process is busy servicing the client.

Since the connected descriptors in the parent and child each point to the same file table entry, it is crucial for the parent to close its copy of the connected



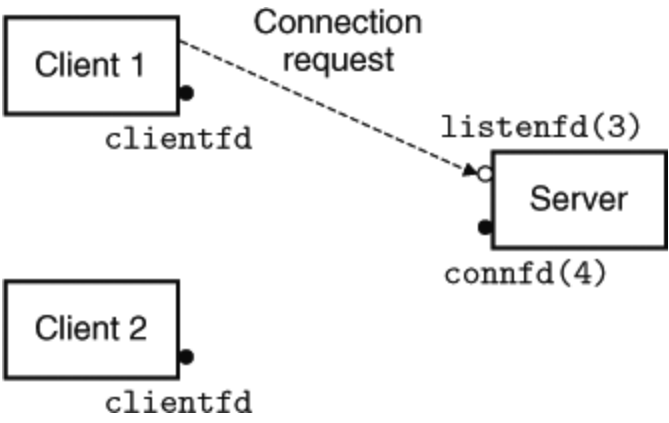


Figure 12.1 Step 1: Server accepts connection request from client.

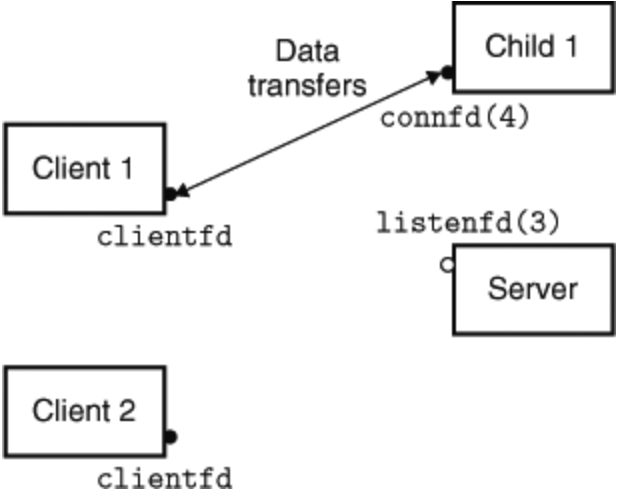
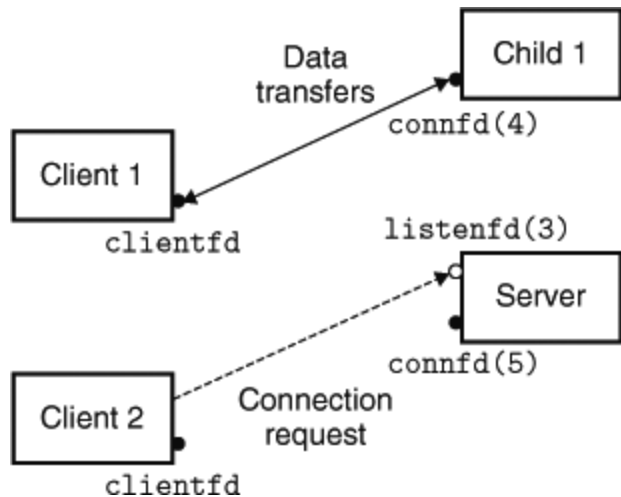


Figure 12.2 Step 2: Server forks a child process to service the client.





**Figure 12.3 Step 3: Server accepts another connection request.**

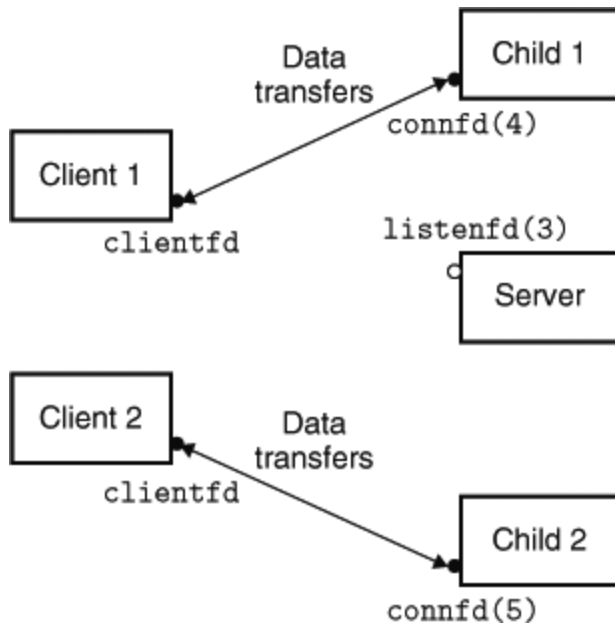
descriptor. Otherwise, the file table entry for connected descriptor 4 will never be released, and the resulting memory leak will eventually consume the available memory and crash the system.

Now suppose that after the parent creates the child for client 1, it accepts a new connection request from client 2 and returns a new connected descriptor (say, 5), as shown in [Figure 12.3](#). The parent then forks another child, which begins servicing its client using connected descriptor 5, as shown in [Figure 12.4](#). At this point, the parent is waiting for the next connection request and the two children are servicing their respective clients concurrently.

# 12.1.1 A Concurrent Server Based on Processes

**Figure 12.5**  shows the code for a concurrent echo server based on processes. The echo function called in line 29 comes from **Figure 11.22** . There are several important points to make about this server:

- First, servers typically run for long periods of time, so we must include a SIGCHLD handler that reaps zombie children (lines 4–9). Since SIGCHLD signals are blocked while the SIGCHLD handler is executing, and since Linux signals are not queued, the SIGCHLD handler must be prepared to reap multiple zombie children.
- Second, the parent and the child must close their respective copies of `connfd` (lines 33 and 30, respectively). As we have mentioned, this is especially important



**Figure 12.4 Step 4: Server forks another child to service the new client.**

for the parent, which must close its copy of the connected descriptor to avoid a memory leak.


- Finally, because of the reference count in the socket's file table entry, the connection to the client will not be terminated until both the parent's and child's copies of `connfd` are closed.

## 12.1.2 Pros and Cons of Processes

Processes have a clean model for sharing state information between parents and children: file tables are shared and user address spaces are not. Having separate address spaces for processes is both an advantage and a disadvantage. It is impossible for one process to accidentally overwrite the virtual memory of another process, which eliminates a lot of confusing failures—an obvious advantage.

On the other hand, separate address spaces make it more difficult for processes to share state information. To share information, they must use explicit IPC (interprocess communications) mechanisms. (See the Aside on [page 977](#).) Another disadvantage of process-based designs is that they tend to be slower because the overhead for process control and IPC is high.

### *Practice Problem 12.1 (solution page **1036**)*

After the parent closes the connected descriptor in line 33 of the concurrent server in [Figure 12.5](#) , the child is still able to communicate with the client using its copy of the descriptor. Why?

## *Practice Problem 12.2 (solution page 1036)*

If we were to delete line 30 of [Figure 12.5](#), which closes the connected descriptor, the code would still be correct, in the sense that there would be no memory leak. Why?

-----code/conc/echoserverp.c

```

1  #include "csapp.h"
2  void echo(int connfd);
3
4  void sigchld_handler(int sig)
5  {
6      while (waitpid(-1, 0, WNOHANG) > 0)
7          ;
8      return;
9  }
10
11 int main(int argc, char **argv)
12 {
13     int listenfd, connfd;
14     socklen_t clientlen;
15     struct sockaddr_storage clientaddr;
16
17     if (argc != 2) {
18         fprintf(stderr, "usage: %s <port>\n",
19 argv[0]);
20         exit(0);
21     }
22     Signal(SIGCHLD, sigchld_handler);
23     listenfd = Open_listenfd(argv[1]);
24     while (1) {
25         clientlen = sizeof(struct
sockaddr_storage);

```



```

26         connfd = Accept(listenfd, (SA *)
&clientaddr, &clientlen);
27         if (Fork() == 0) {
28             Close(listenfd); /* Child closes
its listening socket */
29             echo(connfd); /* Child
services client */
30             Close(connfd); /* Child closes
connection with client */
31             exit(0); /* Child exits
*/
32         }
33         Close(connfd); /* Parent closes
connected socket (important!) */
34     }
35 }

```

-----code/conc/echoserverp.c

**Figure 12.5 Concurrent echo server based on processes.**  
The parent forks a child to handle each new connection request.

## Aside Unix IPC

You have already encountered several examples of IPC in this text. The `waitpid` function and signals from [Chapter 8](#) are primitive IPC mechanisms that allow processes to send tiny messages to process running on the same host. The sockets interface from [Chapter 11](#) is an important form of IPC that allows processes on different hosts to exchange arbitrary byte streams. However, the term *Unix IPC* is typically reserved for a hodgepodge of techniques that allow processes to communicate with other processes that are running on the same host. Examples include pipes, FIFOs, System V shared memory, and System V semaphores. These mechanisms are beyond our scope. The book by Kerrisk [\[62\]](#) is an excellent reference.

[OceanofPDF.com](http://OceanofPDF.com)

## 12.2 Concurrent Programming with I/O Multiplexing

Suppose you are asked to write an echo server that can also respond to interactive commands that the user types to standard input. In this case, the server must respond to two independent I/O events: (1) a network client making a connection request, and (2) a user typing a command line at the keyboard. Which event do we wait for first? Neither option is ideal. If we are waiting for a connection request in `accept`, then we cannot respond to input commands. Similarly, if we are waiting for an input command in `read`, then we cannot respond to any connection requests.

One solution to this dilemma is a technique called *I/O multiplexing*. The basic idea is to use the `select` function to ask the kernel to suspend the process, returning control to the application only after one or more I/O events have occurred, as in the following examples:

- Return when any descriptor in the set {0, 4} is ready for reading.
- Return when any descriptor in the set {1, 2, 7} is ready for writing.
- Time out if 152.13 seconds have elapsed waiting for an I/O event to occur.

`select` is a complicated function with many different usage scenarios. We will only discuss the first scenario: waiting for a set of

descriptors to be ready for reading. See [62, 110] for a complete discussion.

```
|
#include <sys/select.h>
int select(int n, fd_set *fdset, NULL, NULL, NULL);
Returns: nonzero count of ready
descriptors, --1 on error
FD_ZERO(fd_set *fdset); /* Clear all bits in
fdset */
FD_CLR(int fd, fd_set *fdset); /* Clear bit fd in fdset
*/
FD_SET(int fd, fd_set *fdset); /* Turn on bit fd in
fdset */
FD_ISSET(int fd, fd_set *fdset); /* Is bit fd in fdset
on? */
Macros for
manipulating descriptor sets
```

The `select` function manipulates sets of type `fd_set`, which are known as *descriptor sets*. Logically, we think of a descriptor set as a bit vector (introduced in [Section 2.1](#)) of size  $n$ :



$$b_{n-1}, \dots, b_1, b_0$$

Each bit  $b_k$  corresponds to descriptor  $k$ . Descriptor  $k$  is a member of the descriptor set if and only if  $b_k = 1$ . You are only allowed to do

three things with descriptor sets: (1) allocate them, (2) assign one variable of this type to another, and (3) modify and inspect them using the `FD_ZERO`, `FD_SET`, `FD_CLR`, and `FD_ISSET` macros.

For our purposes, the `select` function takes two inputs: a descriptor set (`fdset`) called the *read set*, and the cardinality ( $n$ ) of the read set (actually the maximum cardinality of any descriptor set). The `select` function blocks until at least one descriptor in the read set is ready for reading. A descriptor  $k$  is *ready for reading* if and only if a request to read 1 byte from that descriptor would not block. As a side effect, `select` modifies the `fd_set` pointed to by argument `fdset` to indicate a subset of the read set called the *ready set*, consisting of the descriptors in the read set that are ready for reading. The value returned by the function indicates the cardinality of the ready set. Note that because of the side effect, we must update the read set every time `select` is called.

The best way to understand `select` is to study a concrete example.

**Figure 12.6**  shows how we might use `select` to implement an iterative echo server that also accepts user commands on the standard input. We begin by using the `open_listenfd` function from **Figure 11.19**  to open a listening descriptor (line 16), and then using `FD_ZERO` to create an empty read set (line 18):

	listenfd			stdin
	3	2	1	0
read_set ( $\emptyset$ ):	0	0	0	0

Next, in lines 19 and 20, we define the read set to consist of descriptor 0 (standard input) and descriptor 3 (the listening descriptor), respectively:

	listenfd		stdin	
	3	2	1	0
read_set ({0,3}):	1	0	0	1

At this point, we begin the typical server loop. But instead of waiting for a connection request by calling the `accept` function, we call the `select` function, which blocks until either the listening descriptor or standard input is ready for reading (line 24). For example, here is the value of `ready_set` that `select` would return if the user hit the enter key, thus causing the standard input descriptor to

-----code/conc/select.c

```

1  #include "csapp.h"
2  void echo(int connfd);
3  void command(void);
4
5  int main(int argc, char **argv)
6  {
7      int listenfd, connfd;
8      socklen_t clientlen;
9      struct sockaddr_storage clientaddr;
10     fd_set read_set, ready_set;
11
12     if (argc != 2) {
13         fprintf(stderr, "usage: %s <port>\n",
14             argv[0]);
15         exit(0);
16     }
17     listenfd = Open_listenfd(argv[1]);
18     FD_ZERO(&read_set);          /* Clear
19     read set */
20     FD_SET(STDIN_FILENO, &read_set);    /* Add
21     stdin to read set */
22     FD_SET(listenfd, &read_set);        /* Add
23     listenfd to read set */
24
25     while (1) {
26         ready_set = read_set;

```



```

24         Select(listenfd+1, &ready_set, NULL,
NULL, NULL);
25         if (FD_ISSET(STDIN_FILENO, &ready_set))
26             command(); /* Read command line
from stdin */
27         if (FD_ISSET(listenfd, &ready_set)) {
28             clientlen = sizeof(struct
sockaddr_storage);
29             connfd = Accept(listenfd, (SA
*)&clientaddr, &clientlen);
30             echo(connfd); /* Echo client
input until EOF */
31             Close(connfd);
32         }
33     }
34 }
35
36 void command(void) {
37     char buf[MAXLINE];
38     if (!Fgets(buf, MAXLINE, stdin))
39         exit(0); /* EOF */
40     printf("%s", buf); /* Process the input command
*/
41 }

```

-----code/conc/select.c

**Figure 12.6** An iterative echo server that uses I/O multiplexing.

The server uses `select` to wait for connection requests on a listening descriptor and commands on standard input.


become ready for reading:

	listenfd			stdin
	3	2	1	0
ready_set ({0}):	0	0	0	1

Once `select` returns, we use the `FD_ISSET` macro to determine which descriptors are ready for reading. If standard input is ready (line 25), we call the `command` function, which reads, parses, and responds to the command before returning to the main routine. If the listening descriptor is ready (line 27), we call `accept` to get a connected descriptor and then call the `echo` function from [Figure 11.22](#), which echoes each line from the client until the client closes its end of the connection.


While this program is a good example of using `select`, it still leaves something to be desired. The problem is that once it connects to a client, it continues echoing input lines until the client closes its end of the connection. Thus, if you type a command to standard input, you will not get a response until the server is finished with the client. A better approach would be to multiplex at a finer granularity, echoing (at most) one text line each time through the server loop.

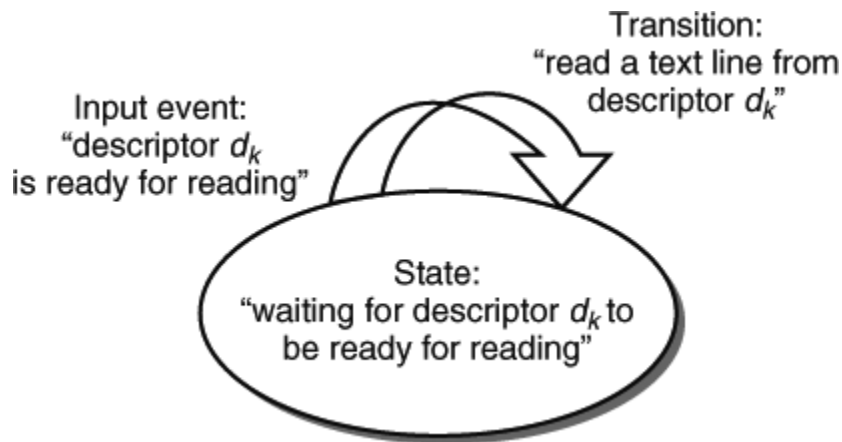
# Practice Problem 12.3 (solution page **1036**)

In Linux systems, typing Ctrl+D indicates EOF on standard input. What happens if you type Ctrl+D to the program in [Figure 12.6](#)  while it is blocked in the call to `select`?

## 12.2.1 A Concurrent Event-Driven Server Based on I/O Multiplexing


I/O multiplexing can be used as the basis for concurrent *event-driven* programs, where flows make progress as a result of certain events. The general idea is to model logical flows as state machines. Informally, a *state machine* is a collection of *states*, *input events*, and *transitions* that map states and input events to states. Each transition maps an (input state, input event) pair to an output state. A *self-loop* is a transition between the same input and output state. State machines are typically drawn as directed graphs, where nodes represent states, directed arcs represent transitions, and arc labels represent input events. A state machine begins execution in some initial state. Each input event triggers a transition from the current state to the next state.

For each new client  $k$ , a concurrent server based on I/O multiplexing creates a new state machine  $s_k$  and associates it with connected descriptor  $d_k$ . As shown in [Figure 12.7](#) , each state machine  $s_k$  has one state ("waiting for descriptor  $d_k$  to be ready for reading"), one input event ("descriptor  $d_k$  is ready for reading"), and one transition ("read a text line from descriptor  $d_k$ ").





**Figure 12.7** State machine for a logical flow in a concurrent event-driven echo server.


The server uses the I/O multiplexing, courtesy of the `select` function, to detect the occurrence of input events. As each connected descriptor becomes ready for reading, the server executes the transition for the corresponding state machine—in this case, reading and echoing a text line from the descriptor.

**Figure 12.8**  shows the complete example code for a concurrent event-driven server based on I/O multiplexing. The set of active clients is maintained in a pool structure (lines 3–11). After initializing the pool by calling `init_pool` (line 27), the server enters an infinite loop. During each iteration of this loop, the server calls the `select` function to detect two different kinds of input events: (1) a connection request arriving from a new client, and (2) a connected descriptor for an existing client being ready for reading. When a connection request arrives (line 35), the server opens the connection (line 37) and calls the `add_client` function to add the client to the pool (line

38). Finally, the server calls the `check_clients` function to echo a single text line from each ready connected descriptor (line 42).

The `init_pool` function ([Figure 12.9](#) ) initializes the client pool. The `clientfd` array represents a set of connected descriptors, with the integer `-1` denoting an available slot. Initially, the set of connected descriptors is empty (lines 5–7), and the listening descriptor is the only descriptor in the `select` read set (lines 10–12).

The `add_client` function ([Figure 12.10](#) ) adds a new client to the pool of active clients. After finding an empty slot in the `clientfd` array, the server adds the connected descriptor to the array and initializes a corresponding `RIO` read buffer so that we can call `rio_readlineb` on the descriptor (lines 8–9). We then add the connected descriptor to the `select` read set (line 12), and we update some global properties of the pool. The `maxfd` variable (lines 15–16) keeps track of the largest file descriptor for `select`. The `maxi` variable (lines 17–18) keeps track of the largest index into the `clientfd` array so that the `check_clients` function does not have to search the entire array.

The `check_clients` function in [Figure 12.11](#) ) echoes a text line from each ready connected descriptor. If we are successful in reading a text line from the descriptor, then we echo that line back to the client (lines 15–18). Notice that in line 15, we are maintaining a cumulative count of total bytes received from all clients. If we detect EOF because the client has closed its end of the connection, then

we close our end of the connection (line 23) and remove the descriptor from the pool (lines 24–25).

-----code/conc/echoservers.c



```

1  #include "csapp.h"
2
3  typedef struct {          /* Represents a pool of
connected descriptors */
4      int maxfd;          /* Largest descriptor in
read_set */
5      fd_set read_set;    /* Set of all active descriptors
*/
6      fd_set ready_set;   /* Subset of descriptors ready
for reading */
7      int nready;        /* Number of ready descriptors
from select */
8      int maxi;          /* High water index into client
array */
9      int clientfd[FD_SETSIZE]; /* Set of active
descriptors */
10     rio_t clientrio[FD_SETSIZE]; /* Set of active read
buffers */
11     } pool;
12
13     int byte_cnt = 0;    /* Counts total bytes received
by server */
14
15     int main(int argc, char **argv)
16     {
17         int listenfd, connfd;
18         socklen_t clientlen;

```

```
19         struct sockaddr_storage clientaddr;
20         static pool pool;
21
22         if (argc != 2) {
23             fprintf(stderr, "usage: %s <port>\n",
24 argv[0]);
25             exit(0);
26         }
27         listenfd = Open_listenfd(argv[1]);
28         init_pool(listenfd, &pool);
29         while (1) {
30             /* Wait for listening/connected
31 descriptor(s) to become ready */
32             pool.ready_set = pool.read_set;
33             pool.nready = Select(pool.maxfd+1,
34 &pool.ready_set, NULL, NULL, NULL);
35
36             /* If listening descriptor ready, add
37 new client to pool */
38             if (FD_ISSET(listenfd, &pool.ready_set))
39             {
40                 clientlen = sizeof(struct
41 sockaddr_storage);
42                 connfd = Accept(listenfd, (SA
43 *)&clientaddr, &clientlen);
44                 add_client(connfd, &pool);
45             }
46         }
47     }
48 }
```

```
41             /* Echo a text line from each ready
connected descriptor */
42             check_clients(&pool);
43         }
44     }
```

-----*code/conc/echoservers.c*

**Figure 12.8 Concurrent echo server based on I/O multiplexing.**  
Each server iteration echoes a text line from each ready descriptor.

-----code/conc/echoservers.c

```
|
1 void init_pool(int listenfd, pool *p)
2 {
3     /* Initially, there are no connected descriptors
4     */
5     int i;
6     p->maxi = -1;
7     for (i=0; i< FD_SETSIZE; i++)
8         p->clientfd[i] = -1;
9     /* Initially, listenfd is only member of select
10    read set */
11    p->maxfd = listenfd;
12    FD_ZERO(&p->read_set);
13    FD_SET(listenfd, &p->read_set);
14 }
```

-----code/conc/echoservers.c

**Figure 12.9** `init_pool` initializes the pool of active clients.

-----code/conc/echoservers.c

```

1 void add_client(int connfd, pool *p)
2 {
3     int i;
4     p->nready--;
5     for (i = 0; i < FD_SETSIZE; i++) /* Find an
available slot */
6         if (p->clientfd[i] < 0) {
7             /* Add connected descriptor to
the pool */
8                 p->clientfd[i] = connfd;
9                 Rio_readinitb(&p->clientrio[i],
connfd);
10
11                 /* Add the descriptor to
descriptor set */
12                 FD_SET(connfd, &p->read_set);
13
14                 /* Update max descriptor and
pool high water mark */
15                 if (connfd > p->maxfd)
16                     p->maxfd = connfd;
17                 if (i > p->maxi)
18                     p->maxi = i;
19                 break;
20         }
21     if (i == FD_SETSIZE) /* Couldn't find an empty
slot */

```

```
22         app_error("add_client error: Too many  
clients");  
23     }
```

-----code/conc/echoservers.c

**Figure 12.10** `add_client` adds a new client connection to the pool.

-----code/conc/echoservers.c



```

1 void check_clients(pool *p)
2 {
3     int i, connfd, n;
4     char buf[MAXLINE];
5     rio_t rio;
6
7     for (i = 0; (i <= p->maxi) && (p->nready > 0);
8 i++) {
9         connfd = p->clientfd[i];
10        rio = p->clientrio[i];
11
12        /* If the descriptor is ready, echo a
13        text line from it */
14        if ((connfd > 0) && (FD_ISSET(connfd,
15 &p->ready_set))) {
16            p->nready--;
17            if ((n = Rio_readlineb(&rio,
18 buf, MAXLINE)) != 0) {
19                byte_cnt += n;
20                printf("Server received
21 %d (%d total) bytes on fd %d\n",
22 n, byte_cnt,
23 connfd);
24                Rio_writen(connfd, buf,
25 n);
26            }
27        }
28    }
29 }
30

```

```

21             /* EOF detected, remove
descriptor from pool */
22             else {
23                 Close(connfd);
24                 FD_CLR(connfd, &p-
>read_set);
25                 p->clientfd[i] = -1;
26             }
27         }
28     }
29 }

```

-----code/conc/echoservers.c

**Figure 12.11** `check_clients` services ready client connections.

In terms of the finite state model in [Figure 12.7](#), the `select` function detects input events, and the `add_client` function creates a new logical flow (state machine). The `check_clients` function performs state transitions by echoing input lines, and it also deletes the state machine when the client has finished sending text lines.


## Practice Problem 12.4 (solution page 1036)

In the server in [Figure 12.8](#), we are careful to reinitialize the `pool.ready_set` variable immediately before every call to `select`. Why?

### Aside Event-driven Web servers

Despite the disadvantages outlined in [Section 12.2.2](#), modern high-performance servers such as Node.js, nginx, and Tornado use event-driven programming based on I/O multiplexing, mainly because of the significant performance advantage compared to processes and threads.

## 12.2.2 Pros and Cons of I/O Multiplexing

The server in [Figure 12.8](#)  provides a nice example of the advantages and disadvantages of event-driven programming based on I/O multiplexing. One advantage is that event-driven designs give programmers more control over the behavior of their programs than process-based designs. For example, we can imagine writing an event-driven concurrent server that gives preferred service to some clients, which would be difficult for a concurrent server based on processes.

Another advantage is that an event-driven server based on I/O multiplexing runs in the context of a single process, and thus every logical flow has access to the entire address space of the process. This makes it easy to share data between flows. A related advantage of running as a single process is that you can debug your concurrent server as you would any sequential program, using a familiar debugging tool such as `GDB`. Finally, event-driven designs are often significantly more efficient than process-based designs because they do not require a process context switch to schedule a new flow.

A significant disadvantage of event-driven designs is coding complexity. Our event-driven concurrent echo server requires three times more code than the process-based server. Unfortunately, the complexity increases as the granularity of the concurrency

decreases. By *granularity*, we mean the number of instructions that each logical flow executes per time slice. For instance, in our example concurrent server, the granularity of concurrency is the number of instructions required to read an entire text line. As long as some logical flow is busy reading a text line, no other logical flow can make progress. This is fine for our example, but it makes our event-driven server vulnerable to a malicious client that sends only a partial text line and then halts. Modifying an event-driven server to handle partial text lines is a nontrivial task, but it is handled cleanly and automatically by a process-based design. Another significant disadvantage of event-based designs is that they cannot fully utilize multi-core processors.

[OceanofPDF.com](http://OceanofPDF.com)

## 12.3 Concurrent Programming with Threads


To this point, we have looked at two approaches for creating concurrent logical flows. With the first approach, we use a separate process for each flow. The kernel schedules each process automatically, and each process has its own private address space, which makes it difficult for flows to share data. With the second approach, we create our own logical flows and use I/O multiplexing to explicitly schedule the flows. Because there is only one process, flows share the entire address space. This section introduces a third approach—based on threads—that is a hybrid of these two.

A *thread* is a logical flow that runs in the context of a process. Thus far in this book, our programs have consisted of a single thread per process. But modern systems also allow us to write programs that have multiple threads running concurrently in a single process. The threads are scheduled automatically by the kernel. Each thread has its own *thread context*, including a unique integer *thread ID (TID)*, stack, stack pointer, program counter, general-purpose registers, and condition codes. All threads running in a process share the entire virtual address space of that process.

Logical flows based on threads combine qualities of flows based on processes and I/O multiplexing. Like processes, threads are

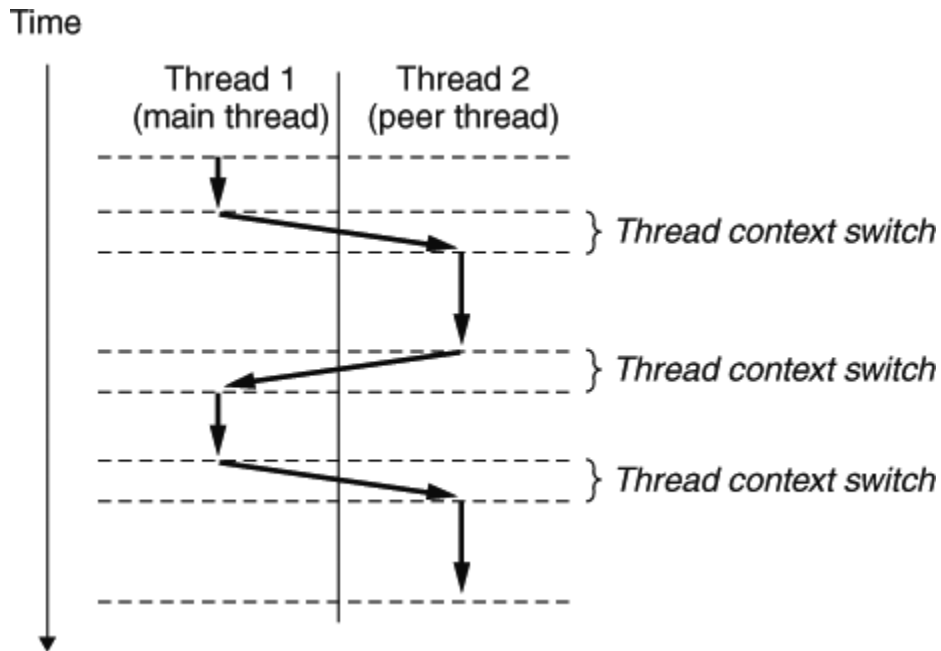
scheduled automatically by the kernel and are known to the kernel by an integer ID. Like flows based on I/O multiplexing, multiple threads run in the context of a single process, and thus they share the entire contents of the process virtual address space, including its code, data, heap, shared libraries, and open files.

## 12.3.1 Thread Execution Model

The execution model for multiple threads is similar in some ways to the execution model for multiple processes. Consider the example in **Figure 12.12** . Each process begins life as a single thread called the *main thread*. At some point, the main thread creates a *peer thread*, and from this point in time the two threads run concurrently. Eventually, control passes to the peer thread via a context switch, either because the main thread executes a slow system call such as `read` or `sleep` or because it is interrupted by the system's interval timer. The peer thread executes for a while before control passes back to the main thread, and so on.

Thread execution differs from processes in some important ways. Because a thread context is much smaller than a process context, a thread context switch is faster than a process context switch. Another difference is that threads, unlike processes, are not organized in a rigid parent-child hierarchy. The threads associated






**Figure 12.12 Concurrent thread execution.**

with a process form a *pool* of peers, independent of which threads were created by which other threads. The main thread is distinguished from other threads only in the sense that it is always the first thread to run in the process. The main impact of this notion of a pool of peers is that a thread can kill any of its peers or wait for any of its peers to terminate. Further, each peer can read and write the same shared data.

## 12.3.2 Posix Threads

Posix threads (Pthreads) is a standard interface for manipulating threads from C programs. It was adopted in 1995 and is available on all Linux systems. Pthreads defines about 60 functions that allow programs to create, kill, and reap threads, to share data safely with peer threads, and to notify peers about changes in the system state.

**Figure 12.13**  shows a simple Pthreads program. The main thread creates a peer thread and then waits for it to terminate. The peer thread prints `Hello, world!\n` and terminates. When the main thread detects that the peer thread has terminated, it terminates the process by calling `exit`. This is the first threaded program we have seen, so let us dissect it carefully. The code and local data for a thread are encapsulated in a *thread routine*. As shown by the prototype in line 2, each thread routine takes as input a single generic pointer and returns a generic pointer. If you want to pass multiple arguments to a thread routine, then you should put the arguments into a structure and pass a pointer to the structure. Similarly, if you

-----code/conc/hello.c

```
1  #include "csapp.h"
2  void *thread(void *vargp);
3
4  int main()
5  {
6      pthread_t tid;
7      Pthread_create(&tid, NULL, thread, NULL);
8      Pthread_join(tid, NULL);
9      exit(0);
10 }
11
12 void *thread(void *vargp) /* Thread routine */
13 {
14     printf("Hello, world!\n");
15     return NULL;
16 }
```

-----code/conc/hello.c

**Figure 12.13** `hello.c`: The Pthreads "Hello, world!" program.

want the thread routine to return multiple arguments, you can return a pointer to a structure.

Line 4 marks the beginning of the code for the main thread. The main thread declares a single local variable `tid`, which will be used to store the thread ID of the peer thread (line 6). The main thread creates a new peer thread by calling the `pthread_create` function (line 7). When the call to `pthread_create` returns, the main thread and the newly created peer thread are running concurrently, and `tid` contains the ID of the new thread. The main thread waits for the peer thread to terminate with the call to `pthread_join` in line 8. Finally, the main thread calls `exit` (line 9), which terminates all threads (in this case, just the main thread) currently running in the process.

Lines 12–16 define the thread routine for the peer thread. It simply prints a string and then terminates the peer thread by executing the `return` statement in line 15.

## 12.3.3 Creating Threads

Threads create other threads by calling the `pthread_create` function.

```
|  
#include <pthread.h>  
typedef void *(func)(void *);  
int pthread_create(pthread_t *tid, pthread_attr_t *attr,  
                  func *f, void *arg);  
Returns: 0 if OK,  
nonzero on error
```

The `pthread_create` function creates a new thread and runs the *thread routine* `f` in the context of the new thread and with an input argument of `arg`. The `attr` argument can be used to change the default attributes of the newly created thread. Changing these attributes is beyond our scope, and in our examples, we will always call `pthread_create` with a NULL `attr` argument.

When `pthread_create` returns, argument `tid` contains the ID of the newly created thread. The new thread can determine its own thread ID by calling the `pthread_self` function.

|

```
#include <pthread.h>
```

```
pthread_t pthread_self(void);
```

Returns: thread

ID of caller

## 12.3.4 Terminating Threads

A thread terminates in one of the following ways:

- The thread terminates *implicitly* when its top-level thread routine returns.
- The thread terminates *explicitly* by calling the `pthread_exit` function. If the main thread calls `pthread_exit`, it waits for all other peer threads to terminate and then terminates the main thread and the entire process with a return value of `thread_return`.

```
|  
#include <pthread.h>  
void pthread_exit(void *thread_return);  
Never returns
```

- Some peer thread calls the Linux `exit` function, which terminates the process and all threads associated with the process.
- Another peer thread terminates the current thread by calling the `pthread_cancel` function with the ID of the current thread.

```
|  
#include <pthread.h>  
int pthread_cancel(pthread_t tid);  
Returns: 0 if OK,  
nonzero on error
```

## 12.3.5 Reaping Terminated Threads

Threads wait for other threads to terminate by calling the `pthread_join` function.

```
|  
#include <pthread.h>  
int pthread_join(pthread_t tid, void **thread_return);  
Returns: 0 if OK,  
nonzero on error
```

The `pthread_join` function blocks until thread `tid` terminates, assigns the generic (`void *`) pointer returned by the thread routine to the location pointed to by `thread_return`, and then *reaps* any memory resources held by the terminated thread.

Notice that, unlike the Linux `wait` function, the `pthread_join` function can only wait for a specific thread to terminate. There is no way to instruct `pthread_join` to wait for an *arbitrary* thread to terminate. This can complicate our code by forcing us to use other, less intuitive mechanisms to detect process termination. Indeed, Stevens argues convincingly that this is a bug in the specification [110].



## 12.3.6 Detaching Threads

At any point in time, a thread is *joinable* or *detached*. A joinable thread can be reaped and killed by other threads. Its memory resources (such as the stack) are not freed until it is reaped by another thread. In contrast, a detached thread cannot be reaped or killed by other threads. Its memory resources are freed automatically by the system when it terminates.

By default, threads are created joinable. In order to avoid memory leaks, each joinable thread should be either explicitly reaped by another thread or detached by a call to the `pthread_detach` function.

```
|  
#include <pthread.h>  
int pthread_detach(pthread_t tid);  
Returns: 0 if OK,  
nonzero on error
```

The `pthread_detach` function detaches the joinable thread `tid`. Threads can detach themselves by calling `pthread_detach` with an argument of `pthread_self()`.


Although some of our examples will use joinable threads, there are good reasons to use detached threads in real programs. For

example, a high-performance Web server might create a new peer thread each time it receives a connection request from a Web browser. Since each connection is handled independently by a separate thread, it is unnecessary—and indeed undesirable—for the server to explicitly wait for each peer thread to terminate. In this case, each peer thread should detach itself before it begins processing the request so that its memory resources can be reclaimed after it terminates.


## 12.3.7 Initializing Threads

The `pthread_once` function allows you to initialize the state associated with a thread routine.

```
|  
#include <pthread.h>  
pthread_once_t once_control = PTHREAD_ONCE_INIT;  
int pthread_once(pthread_once_t *once_control,  
                void (*init_routine)(void));  
Always returns 0
```

The `once_control` variable is a global or static variable that is always initialized to `PTHREAD_ONCE_INIT`. The first time you call `pthread_once` with an argument of `once_control`, it invokes `init_routine`, which is a function with no input arguments that returns nothing. Subsequent calls to `pthread_once` with the same `once_control` variable do nothing. The `pthread_once` function is useful whenever you need to dynamically initialize global variables that are shared by multiple threads. We will look at an example in [Section 12.5.5](#) .

## 12.3.8 A Concurrent Server Based on Threads

**Figure 12.14**  shows the code for a concurrent echo server based on threads. The overall structure is similar to the process-based design. The main thread repeatedly waits for a connection request and then creates a peer thread to handle the request. While the code looks simple, there are a couple of general and somewhat subtle issues we need to look at more closely. The first issue is how to pass

-----code/conc/echoservt.c

```

1  #include "csapp.h"
2
3  void echo(int connfd);
4  void *thread(void *vargp);
5
6  int main(int argc, char **argv)
7  {
8      int listenfd, *connfdp;
9      socklen_t clientlen;
10     struct sockaddr_storage clientaddr;
11     pthread_t tid;
12
13     if (argc != 2) {
14         fprintf(stderr, "usage: %s <port>\n",
15 argv[0]);
16         exit(0);
17     }
18     listenfd = Open_listenfd(argv[1]);
19     while (1) {
20         clientlen=sizeof(struct
21 sockaddr_storage);
22         connfdp = Malloc(sizeof(int));
23         *connfdp = Accept(listenfd, (SA *)
24 &clientaddr, &clientlen);
25         Pthread_create(&tid, NULL, thread,
26 connfdp);
27     }

```

```

25     }
26
27     /* Thread routine */
28     void *thread(void *vargp)
29     {
30         int connfd = *((int *)vargp);
31         Pthread_detach(pthread_self());
32         Free(vargp);
33         echo(connfd);
34         Close(connfd);
35         return NULL;
36     }

```

-----code/conc/echoservt.c

**Figure 12.14 Concurrent echo server based on threads.**

the connected descriptor to the peer thread when we call `pthread_create`. The obvious approach is to pass a pointer to the descriptor, as in the following:

```

connfd = Accept(listenfd, (SA *) &clientaddr, &clientlen);
Pthread_create(&tid, NULL, thread, &connfd);

```

Then we have the peer thread dereference the pointer and assign it to a local variable, as follows:

```
|  
void *thread(void *vargp) {  
    int connfd = *((int *)vargp);  
    :  
}
```

This would be wrong, however, because it introduces a *race* between the assignment statement in the peer thread and the `accept` statement in the main thread. If the assignment statement completes before the next `accept`, then the local `connfd` variable in the peer thread gets the correct descriptor value. However, if the assignment completes *after* the `accept`, then the local `connfd` variable in the peer thread gets the descriptor number of the *next* connection. The unhappy result is that two threads are now performing input and output on the same descriptor. In order to avoid the potentially deadly race, we must assign each connected descriptor returned by `accept` to its own dynamically allocated memory block, as shown in lines 21–22. We will return to the issue of races in [Section 12.7.4](#).

Another issue is avoiding memory leaks in the thread routine. Since we are not explicitly reaping threads, we must detach each thread so that its memory resources will be reclaimed when it terminates (line 31). Further, we must be careful to free the memory block that was allocated by the main thread (line 32).



## *Practice Problem 12.5 (solution page 1036)*

In the process-based server in [Figure 12.5](#), we were careful to close the connected descriptor in two places: the parent process and the child process. However, in the threads-based server in [Figure 12.14](#), we only closed the connected descriptor in one place: the peer thread. Why?

[OceanofPDF.com](http://OceanofPDF.com)

## 12.4 Shared Variables in Threaded Programs

From a programmer's perspective, one of the attractive aspects of threads is the ease with which multiple threads can share the same program variables. However, this sharing can be tricky. In order to write correctly threaded programs, we must have a clear understanding of what we mean by sharing and how it works.

There are some basic questions to work through in order to understand whether a variable in a C program is shared or not: (1) What is the underlying memory model for threads? (2) Given this model, how are instances of the variable mapped to memory? (3) Finally, how many threads reference each of these

-----code/conc/sharing.c

```
|
1  #include "csapp.h"
2  #define N 2
3  void *thread(void *vargp);
4
5  char **ptr; /* Global variable */
6
7  int main()
8  {
9      int i;
10     pthread_t tid;
11     char *msgs[N] = {
12         "Hello from foo",
13         "Hello from bar"
14     };
15
16     ptr = msgs;
17     for (i = 0; i < N; i++)
18         Pthread_create(&tid, NULL, thread, (void
19 *)i);
19     Pthread_exit(NULL);
20 }
21
22 void *thread(void *vargp)
23 {
24     int myid = (int)vargp;
25     static int cnt = 0;
26     printf("[%d]: %s (cnt=%d)\n", myid, ptr[myid],
```

```
++cnt);  
27         return NULL;  
28     }
```

-----code/conc/sharing.c

**Figure 12.15 Example program that illustrates different aspects of sharing.**

instances? The variable is *shared* if and only if multiple threads reference some instance of the variable.

To keep our discussion of sharing concrete, we will use the program in [Figure 12.15](#) as a running example. Although somewhat contrived, it is nonetheless useful to study because it illustrates a number of subtle points about sharing. The example program consists of a main thread that creates two peer threads. The main thread passes a unique ID to each peer thread, which uses the ID to print a personalized message along with a count of the total number of times that the thread routine has been invoked.

## 12.4.1 Threads Memory Model

A pool of concurrent threads runs in the context of a process. Each thread has its own separate *thread context*, which includes a thread ID, stack, stack pointer, program counter, condition codes, and general-purpose register values. Each thread shares the rest of the process context with the other threads. This includes the entire user virtual address space, which consists of read-only text (code), read/write data, the heap, and any shared library code and data areas. The threads also share the same set of open files.

In an operational sense, it is impossible for one thread to read or write the register values of another thread. On the other hand, any thread can access any location in the shared virtual memory. If some thread modifies a memory location, then every other thread will eventually see the change if it reads that location. Thus, registers are never shared, whereas virtual memory is always shared.

The memory model for the separate thread stacks is not as clean. These stacks are contained in the stack area of the virtual address space and are *usually* accessed independently by their respective threads. We say *usually* rather than *always*, because different thread stacks are not protected from other threads. So if a thread somehow manages to acquire a pointer to another thread's stack, then it can read and write any part of that stack. Our example program shows this in line 26, where the peer threads reference the contents of the main thread's stack indirectly through the global `ptr` variable.

# 12.4.2 Mapping Variables to Memory

Variables in threaded C programs are mapped to virtual memory according to their storage classes:

**Global variables.** A *global variable* is any variable declared outside of a function. At run time, the read/write area of virtual memory contains exactly one instance of each global variable that can be referenced by any thread. For example, the global `ptr` variable declared in line 5 has one run-time instance in the read/write area of virtual memory. When there is only one instance of a variable, we will denote the instance by simply using the variable name—in this case, `ptr`.

**Local automatic variables.** A *local automatic variable* is one that is declared inside a function without the `static` attribute. At run time, each thread's stack contains its own instances of any local automatic variables. This is true even if multiple threads execute the same thread routine. For example, there is one instance of the local variable `tid`, and it resides on the stack of the main thread. We will denote this instance as `tid.m`. As another example, there are two instances of the local variable `myid`, one instance on the stack of peer thread 0 and the other on the stack of peer thread 1. We will denote these instances as `myid.p0` and `myid.p1`, respectively.

**Local static variables.** A *local static variable* is one that is declared inside a function with the `static` attribute. As with global variables, the read/write area of virtual memory contains exactly one instance of each local static variable declared in a program. For example, even though each peer thread in our example program declares `cnt` in line 25, at run time there is only one instance of `cnt` residing in the read/write area of virtual memory. Each peer thread reads and writes this instance.



## 12.4.3 Shared Variables

We say that a variable  $v$  is *shared* if and only if one of its instances is referenced by more than one thread. For example, variable `cnt` in our example program is shared because it has only one run-time instance and this instance is referenced by both peer threads. On the other hand, `myid` is not shared, because each of its two instances is referenced by exactly one thread. However, it is important to realize that local automatic variables such as `msgs` can also be shared.

## Practice Problem 12.6 (solution page 1036)

Using the analysis from [Section 12.4](#), fill each entry in the following table with "Yes" or "No" for the example program in [Figure 12.15](#). In the first column, the notation  $v.t$  denotes an instance of variable  $v$  residing on the local stack for thread  $t$ , where  $t$  is either `m` (main thread), `p0` (peer thread 0), or `p1` (peer thread 1).

Given the analysis in part A, which of the variables `ptr`, `cnt`, `i`, `msgs`, and `myid` are shared?

## 12.5 Synchronizing Threads with Semaphores

Shared variables can be convenient, but they introduce the possibility of nasty *synchronization errors*. Consider the `badcnt.c` program in [Figure 12.16](#), which creates two threads, each of which increments a global shared counter variable called `cnt`.

Since each thread increments the counter `niters` times, we expect its final value to be `2 × niters`. This seems quite simple and straightforward. However, when we run `badcnt.c` on our Linux system, we not only get wrong answers, we get different answers each time!

-----code/conc/badcnt.c

```
1      /* WARNING: This code is buggy! */
2      #include "csapp.h"
3
4      void *thread(void *vargp); /* Thread routine prototype
*/
5
6      /* Global shared variable */
7      volatile long cnt = 0; /* Counter */ 8
9      int main(int argc, char **argv)
10     {
11         long niters;
12         pthread_t tid1, tid2;
13
14         /* Check input argument */
15         if (argc != 2) {
16             printf("usage: %s <niters>\n", argv[0]);
17             exit(0);
18         }
19         niters = atoi(argv[1]);
20
21         /* Create threads and wait for them to finish */
22         Pthread_create(&tid1, NULL, thread, &niters);
23         Pthread_create(&tid2, NULL, thread, &niters);
24         Pthread_join(tid1, NULL);
25         Pthread_join(tid2, NULL);
26
27         /* Check result */
```

```

28         if (cnt != (2 * niters))
29             printf("BOOM! cnt=%ld\n", cnt);
30         else
31             printf("OK cnt=%ld\n", cnt);
32         exit(0);
33     }
34
35     /* Thread routine */
36     void *thread(void *vargp)
37     {
38         long i, niters = *((long *)vargp);
39
40         for (i = 0; i < niters; i++)
41             cnt++;
42
43         return NULL;
44     }

```

-----code/conc/badcnt.c

**Figure 12.16** `badcnt.c`: An improperly synchronized counter program.

```
linux> ./badcnt 1000000
BOOM! cnt=1445085
linux> ./badcnt 1000000
BOOM! cnt=1915220
linux> ./badcnt 1000000
BOOM! cnt=1404746
```

So what went wrong? To understand the problem clearly, we need to study the assembly code for the counter loop (lines 40–41), as shown in [Figure 12.17](#). We will find it helpful to partition the loop code for thread  $i$  into five parts:

$H_i$ : The block of instructions at the head of the loop

$L_i$ : The instruction that loads the shared variable `cnt` into the accumulator register `%rdxi`, where `%rdxi` denotes the value of register `%rdx` in thread  $i$

$U_i$ : The instruction that updates (increments) `%rdxi`

$S_i$ : The instruction that stores the updated value of `%rdxi` back to the shared variable `cnt`

$T_i$ : The block of instructions at the tail of the loop

Notice that the head and tail manipulate only local stack variables, while  $L_i$ ,  $U_i$ , and  $S_i$  manipulate the contents of the shared counter

variable.

When the two peer threads in `badcnt.c` run concurrently on a uniprocessor, the machine instructions are completed one after the other in some order. Thus, each concurrent execution defines some total ordering (or interleaving) of the instructions in the two threads. Unfortunately, some of these orderings will produce correct results, but others will not.

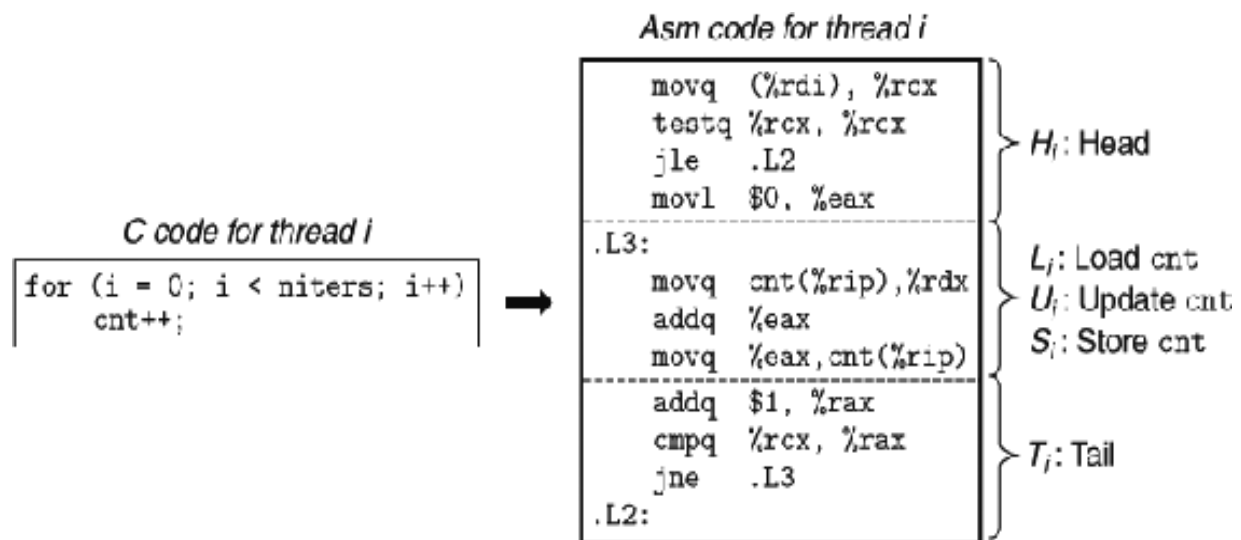




Figure 12.17 Assembly code for the counter loop (lines 40–41) in `badcnt.c`.



## Figure 12.18 Instruction orderings for the first loop iteration in `badcnt.c`.

Here is the crucial point: *In general, there is no way for you to predict whether the operating system will choose a correct ordering for your threads.* For example, **Figure 12.18(a)**  shows the step-by-step operation of a correct instruction ordering. After each thread has updated the shared variable `cnt`, its value in memory is 2, which is the expected result.

On the other hand, the ordering in **Figure 12.18(b)**  produces an incorrect value for `cnt`. The problem occurs because thread 2 loads `cnt` in step 5, after thread 1 loads `cnt` in step 2 but before thread 1 stores its updated value in step 6. Thus, each thread ends up storing an updated counter value of 1. We can clarify these notions of correct and incorrect instruction orderings with the help of a device known as a *progress graph*, which we introduce in the next section.

# Practice Problem 12.7 (solution page **1037**)


Complete the table for the following instruction ordering of

`badcnt.c`:

Does this ordering result in a correct value for `cnt`?

## 12.5.1 Progress Graphs

A *progress graph* models the execution of  $n$  concurrent threads as a trajectory through an  $n$ -dimensional Cartesian space. Each axis  $k$  corresponds to the progress of thread  $k$ . Each point  $(I_1, I_2, \dots, I_n)$  represents the state where thread  $k$  ( $k = 1, \dots, n$ ) has completed instruction  $I_k$ . The origin of the graph corresponds to the *initial state* where none of the threads has yet completed an instruction.

**Figure 12.19**  shows the two-dimensional progress graph for the first loop iteration of the `badcnt.c` program. The horizontal axis corresponds to thread 1, the vertical axis to thread 2. Point  $(L_1, S_2)$  corresponds to the state where thread 1 has completed  $L_1$  and thread 2 has completed  $S_2$ .

A progress graph models instruction execution as a *transition* from one state to another. A transition is represented as a directed edge from one point to an adjacent point. Legal transitions move to the right (an instruction in thread 1 completes) or up (an instruction in thread 2 completes). Two instructions cannot complete at the same time—diagonal transitions are not allowed. Programs never run backward so transitions that move down or to the left are not legal either.

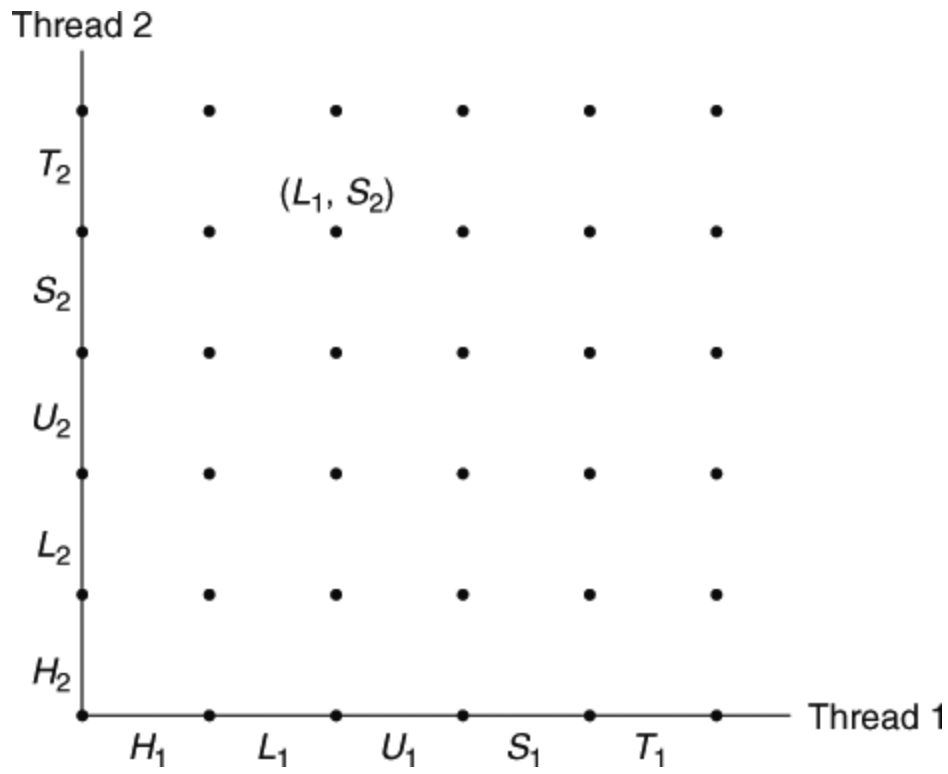
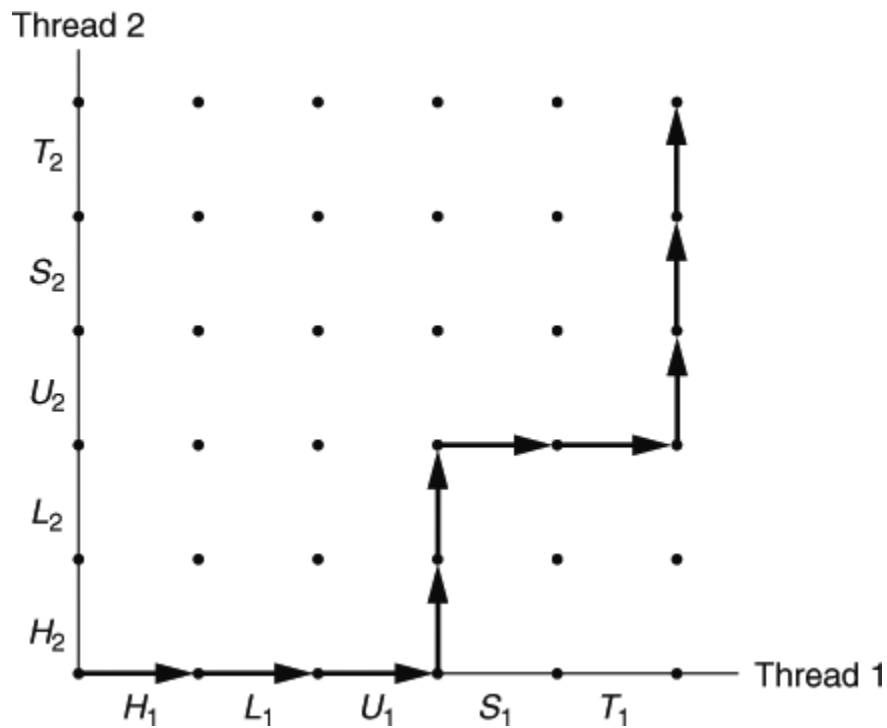


Figure 12.19 Progress graph for the first loop iteration of `badcnt.c`.




**Figure 12.20** An example trajectory.


The execution history of a program is modeled as a *trajectory* through the state space. [Figure 12.20](#) shows the trajectory that corresponds to the following instruction ordering:

$$H_1, L_1, U_1, H_2, L_2, S_1, T_1, U_2, S_2, T_2$$

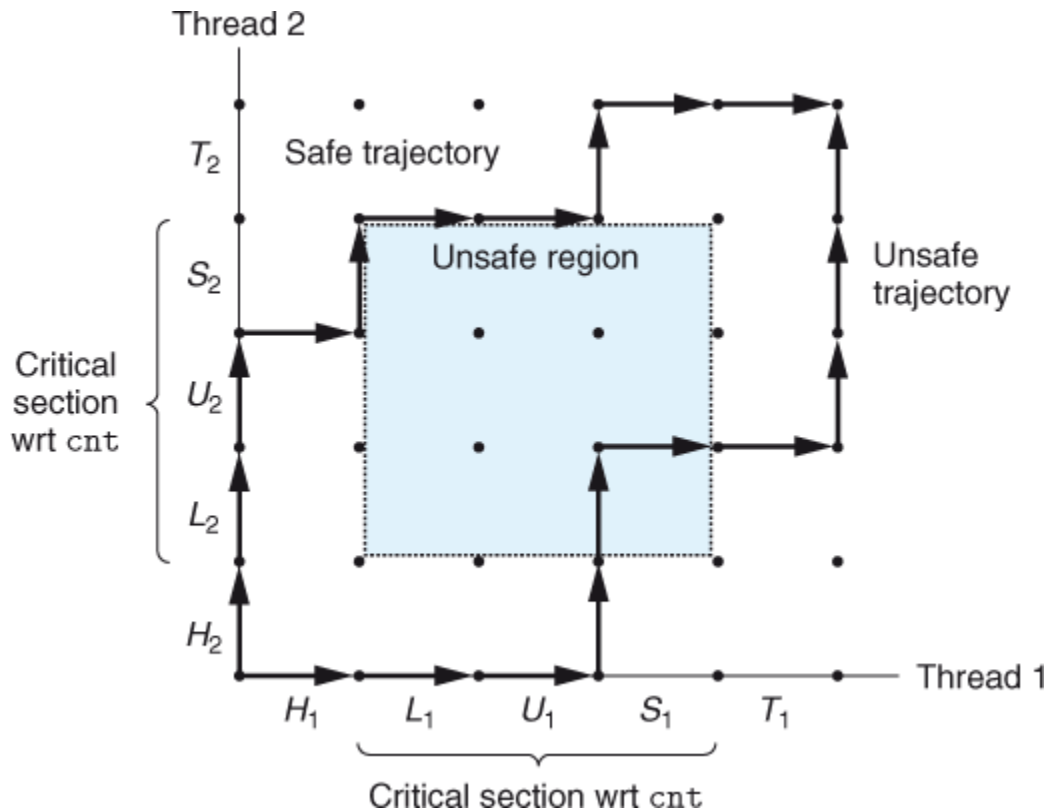
For thread  $i$ , the instructions  $(L_i, U_i, S_i)$  that manipulate the contents of the shared variable `cnt` constitute a *critical section* (with respect to shared variable `cnt`) that should not be interleaved with the critical section of the other thread. In other words, we want to ensure that each thread has *mutually exclusive access* to the shared variable while it is executing the instructions in its critical section. The phenomenon in general is known as *mutual exclusion*.

On the progress graph, the intersection of the two critical sections defines a region of the state space known as an *unsafe region*.

**Figure 12.21**  shows the unsafe region for the variable `cnt`. Notice that the unsafe region abuts, but does not include, the states along its perimeter. For example, states  $(H_1, H_2)$  and  $(S_1, U_2)$  abut the unsafe region, but they are not part of it. A trajectory that skirts the unsafe region is known as a *safe trajectory*. Conversely, a trajectory that touches any part of the unsafe region is an *unsafe trajectory*.

**Figure 12.21**  shows examples of safe and unsafe trajectories through the state space of our example `badcnt.c` program. The upper trajectory skirts the unsafe region along its left and top sides, and thus is safe. The lower trajectory crosses the unsafe region, and thus is unsafe.

Any safe trajectory will correctly update the shared counter. In order to guarantee correct execution of our example threaded program—and indeed any concurrent program that shares global data structures—we must somehow *synchronize* the threads so that they always have a safe trajectory. A classic approach is based on the idea of a semaphore, which we introduce next.



**Figure 12.21 Safe and unsafe trajectories.**

The intersection of the critical regions forms an unsafe region. Trajectories that skirt the unsafe region correctly update the counter variable.

## *Practice Problem 12.8 (solution page 1038)*

Using the progress graph in [Figure 12.21](#), classify the following trajectories as either *safe* or *unsafe*.

- A.  $H_1, L_1, U_1, S_1, H_2, L_2, U_2, S_2, T_2, T_1$
- B.  $H_2, L_2, H_1, L_1, U_1, S_1, T_1, U_2, S_2, T_2$
- C.  $H_1, H_2, L_2, U_2, S_2, L_1, U_1, S_1, T_1, T_2$

## 12.5.2 Semaphores

Edsger Dijkstra, a pioneer of concurrent programming, proposed a classic solution to the problem of synchronizing different execution threads based on a special type of variable called a *semaphore*. A semaphore,  $s$ , is a global variable with a nonnegative integer value that can only be manipulated by two special operations, called  $P$  and  $V$ :

**$P$  ( $s$ ):** If  $s$  is nonzero, then  $P$  decrements  $s$  and returns immediately. If  $s$  is zero, then suspend the thread until  $s$  becomes nonzero and the thread is restarted by a  $V$  operation. After restarting, the  $P$  operation decrements  $s$  and returns control to the caller.

**$V$  ( $s$ ):** The  $V$  operation increments  $s$  by 1. If there are any threads blocked at a  $P$  operation waiting for  $s$  to become nonzero, then the  $V$  operation restarts exactly one of these threads, which then completes its  $P$  operation by decrementing  $s$ .

### Aside Origin of the names $P$ and $V$

Edsger Dijkstra (1930–2002) was originally from the Netherlands. The names  $P$  and  $V$  come from the Dutch words *proberen* (to test) and *verhogen* (to increment).

The test and decrement operations in  $P$  occur indivisibly, in the sense that once the semaphore  $s$  becomes nonzero, the decrement of  $s$  occurs without interruption. The increment operation in  $V$  also



occurs indivisibly, in that it loads, increments, and stores the semaphore without interruption. Notice that the definition of  $V$  does *not* define the order in which waiting threads are restarted. The only requirement is that the  $V$  must restart exactly one waiting thread. *Thus, when several threads are waiting at a semaphore, you cannot predict which one will be restarted as a result of the  $V$ .*

The definitions of  $P$  and  $V$  ensure that a running program can never enter a state where a properly initialized semaphore has a negative value. This property, known as the *semaphore invariant*, provides a powerful tool for controlling the trajectories of concurrent programs, as we shall see in the next section.

The Posix standard defines a variety of functions for manipulating semaphores.

```
|
#include <semaphore.h>
int sem_init(sem_t *sem, 0, unsigned int value);
int sem_wait(sem_t *s); /* P(s) */
int sem_post(sem_t *s); /* V(s) */
Returns: 0 if
OK, -1 on error
```

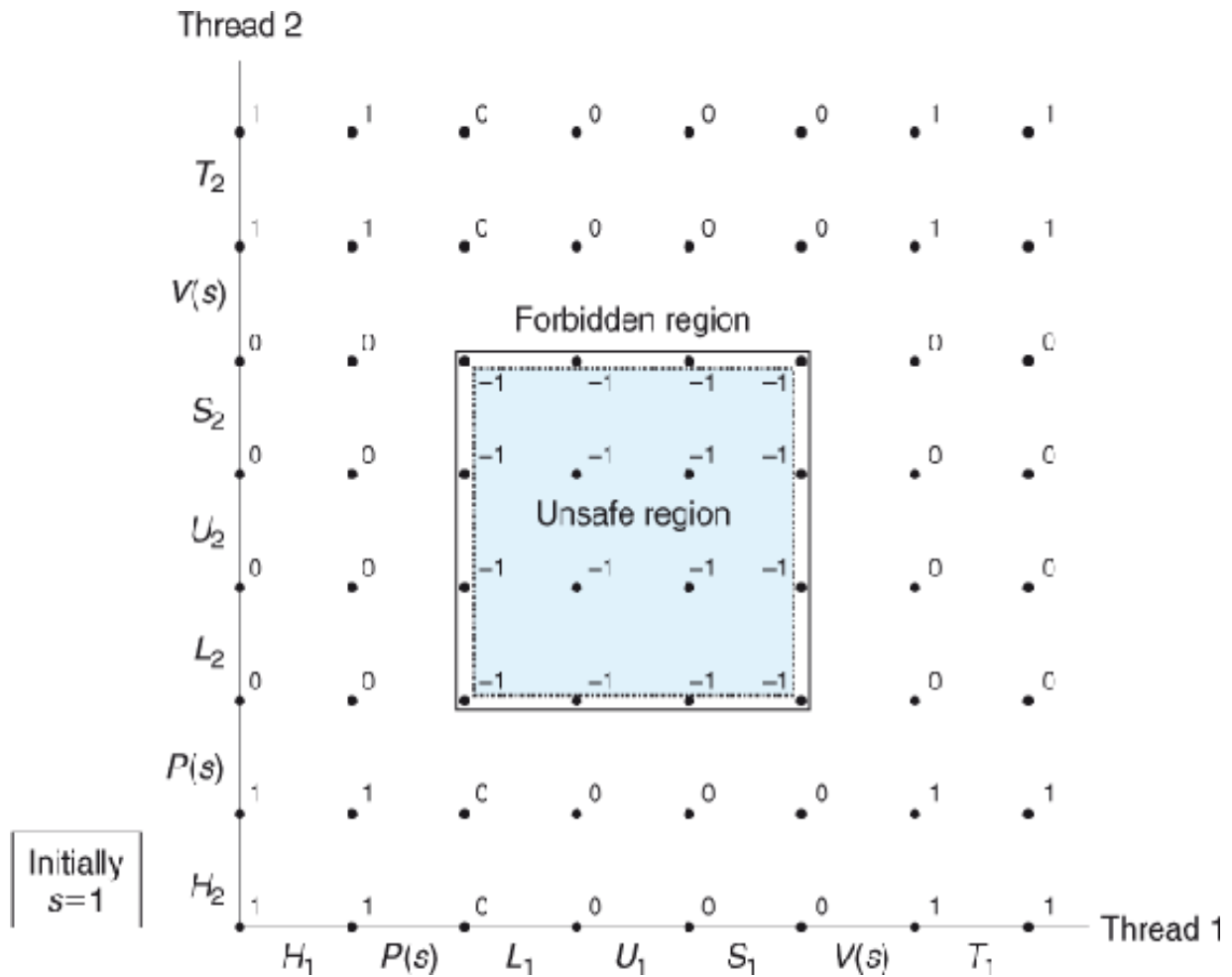
The `sem_init` function initializes semaphore `sem` to `value`. Each semaphore must be initialized before it can be used. For our purposes, the middle argument is always 0. Programs perform  $P$  and

V operations by calling the `sem_wait` and `sem_post` functions, respectively. For conciseness, we prefer to use the following equivalent *P* and *V* wrapper functions instead:

```
|  
#include "csapp.h"  
void P(sem_t *s);      /* Wrapper function for sem_wait */  
void V(sem_t *s);      /* Wrapper function for sem_post */  
                        Returns: nothing
```

## 12.5.3 Using Semaphores for Mutual Exclusion

Semaphores provide a convenient way to ensure mutually exclusive access to shared variables. The basic idea is to associate a semaphore  $s$ , initially 1, with




**Figure 12.22 Using semaphores for mutual exclusion.**

The infeasible states where  $s < 0$  define a *forbidden region* that surrounds the unsafe region and prevents any feasible trajectory from touching the unsafe region.

each shared variable (or related set of shared variables) and then surround the corresponding critical section with  $P(s)$  and  $V(s)$  operations.

A semaphore that is used in this way to protect shared variables is called a *binary semaphore* because its value is always 0 or 1. Binary

semaphores whose purpose is to provide mutual exclusion are often called *mutexes*. Performing a  $P$  operation on a mutex is called *locking* the mutex. Similarly, performing the  $V$  operation is called *unlocking* the mutex. A thread that has locked but not yet unlocked a mutex is said to be *holding* the mutex. A semaphore that is used as a counter for a set of available resources is called a *counting semaphore*.

The progress graph in [Figure 12.22](#)  shows how we would use binary semaphores to properly synchronize our example counter program.

Each state is labeled with the value of semaphore  $s$  in that state. The crucial idea is that this combination of  $P$  and  $V$  operations creates a collection of states, called a *forbidden region*, where  $s < 0$ . Because of the semaphore invariant, no feasible trajectory can include one of the states in the forbidden region. And since the forbidden region completely encloses the unsafe region, no feasible trajectory can touch any part of the unsafe region. Thus, every feasible trajectory is safe, and regardless of the ordering of the instructions at run time, the program correctly increments the counter.

## Aside Limitations of progress graphs

Progress graphs give us a nice way to visualize concurrent program execution on uniprocessors and to understand why we need synchronization. However, they do have limitations, particularly with respect to concurrent execution on multiprocessors, where a set of CPU/cache pairs share the same main memory. Multiprocessors behave in ways that cannot be explained by progress graphs. In particular, a multiprocessor memory system can be in a state that does not correspond to any trajectory in a progress graph. Regardless, the message remains the same: always synchronize accesses to your shared variables, regardless if you're running on a uniprocessor or a multiprocessor.

In an operational sense, the forbidden region created by the  $P$  and  $V$  operations makes it impossible for multiple threads to be executing instructions in the enclosed critical region at any point in time. In other words, the semaphore operations ensure mutually exclusive access to the critical region.

Putting it all together, to properly synchronize the example counter program in [Figure 12.16](#) using semaphores, we first declare a semaphore called mutex:

```
volatile long cnt= 0; /* Counter */  
sem_t mutex; /* Semaphore that protects counter */
```

and then we initialize it to unity in the main routine:

```
Sem_init(&mutex, 0, 1); /* mutex = 1 */
```

Finally, we protect the update of the shared `cnt` variable in the thread routine by surrounding it with **P** and **V** operations:

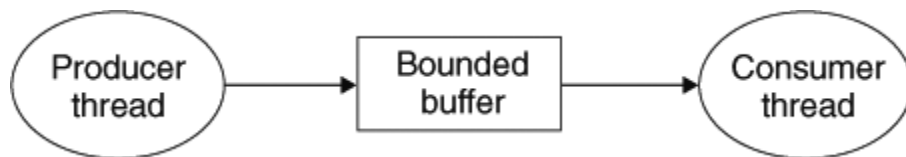
```
|  
for (i = 0; i < niters; i++) {  
    P(&mutex);  
    cnt++;  
    V(&mutex);  
}
```

When we run the properly synchronized program, it now produces the correct answer each time.

```
|  
linux> ./goodcnt 1000000  
OK cnt=2000000  
linux> ./goodcnt 1000000  
OK cnt=2000000
```

## 12.5.4 Using Semaphores to Schedule Shared Resources

Another important use of semaphores, besides providing mutual exclusion, is to schedule accesses to shared resources. In this scenario, a thread uses a semaphore




**Figure 12.23 Producer-consumer problem.**

The producer generates items and inserts them into a bounded buffer. The consumer removes items from the buffer and then consumes them.

operation to notify another thread that some condition in the program state has become true. Two classical and useful examples are the *producer-consumer* and *readers-writers* problems.




# Producer-Consumer Problem

The *producer-consumer* problem is shown in [Figure 12.23](#) . A producer and consumer thread share a *bounded buffer* with  $n$  slots. The producer thread repeatedly produces new *items* and inserts them in the buffer. The consumer thread repeatedly removes items from the buffer and then consumes (uses) them. Variants with multiple producers and consumers are also possible.

Since inserting and removing items involves updating shared variables, we must guarantee mutually exclusive access to the buffer. But guaranteeing mutual exclusion is not sufficient. We also need to schedule accesses to the buffer. If the buffer is full (there are no empty slots), then the producer must wait until a slot becomes available. Similarly, if the buffer is empty (there are no available items), then the consumer must wait until an item becomes available.

Producer-consumer interactions occur frequently in real systems. For example, in a multimedia system, the producer might encode video frames while the consumer decodes and renders them on the screen. The purpose of the buffer is to reduce jitter in the video stream caused by data-dependent differences in the encoding and decoding times for individual frames. The buffer provides a reservoir of slots to the producer and a reservoir of encoded frames to the consumer. Another common example is the design of graphical user interfaces. The producer detects mouse and keyboard events and

inserts them in the buffer. The consumer removes the events from the buffer in some priority-based manner and paints the screen.


In this section, we will develop a simple package, called `SBUF`, for building producer-consumer programs. In the next section, we look at how to use it to build an interesting concurrent server based on prethreading. `SBUF` manipulates bounded buffers of type `sbuf_t` (Figure 12.24 ). Items are stored in a dynamically allocated integer array (`buf`) with `n` items. The `front` and `rear` indices keep track of the first and last items in the array. Three semaphores synchronize access to the buffer. The `mutex` semaphore provides mutually exclusive buffer access. Semaphores `slots` and `items` are counting semaphores that count the number of empty slots and available items, respectively.

-----code/conc/sbuf.h

```
|
1     typedef struct {
2         int *buf;           /* Buffer array */
3         int n;             /* Maximum number of
slots */
4         int front;        /* buf[(front+1)%n] is
first item */
5         int rear;        /* buf[rear%n] is last
item */
6         sem_t mutex;     /* Protects accesses to
buf */
7         sem_t slots;     /* Counts available
slots */
8         sem_t items;     /* Counts available
items */
9     } sbuf_t;
```

-----code/conc/sbuf.h

**Figure 12.24** `sbuf_t`: Bounded buffer used by the `SBUF` package.

**Figure 12.25**  shows the implementation of the `SBUF` package. The `sbuf_init` function allocates heap memory for the buffer, sets `front` and `rear` to indicate an empty buffer, and assigns initial values to the three semaphores. This function is called once, before calls to any of

the other three functions. The `sbuf_deinit` function frees the buffer storage when the application is through using it. The `sbuf_insert` function waits for an available slot, locks the mutex, adds the item, unlocks the mutex, and then announces the availability of a new item. The `sbuf_remove` function is symmetric. After waiting for an available buffer item, it locks the mutex, removes the item from the front of the buffer, unlocks the mutex, and then signals the availability of a new slot.

## Practice Problem 12.9 (solution page [1038](#))

Let  $p$  denote the number of producers,  $c$  the number of consumers, and  $n$  the buffer size in units of items. For each of the following scenarios, indicate whether the mutex semaphore in `sbuf_insert` and `sbuf_remove` is necessary or not.

- A.  $p = 1, c = 1, n > 1$
- B.  $p = 1, c = 1, n = 1$
- C.  $p > 1, c > 1, n = 1$

## *Readers-Writers Problem*

The *readers-writers problem* is a generalization of the mutual exclusion problem. A collection of concurrent threads is accessing a shared object such as a data structure in main memory or a database on disk. Some threads only read the object, while others modify it. Threads that modify the object are called *writers*. Threads that only read it are called *readers*. Writers must have exclusive access to the object, but readers may share the object with an unlimited number of other readers. In general, there are an unbounded number of concurrent readers and writers.

-----code/conc/sbuf.c

```

1  #include "csapp.h"
2  #include "sbuf.h"
3
4  /* Create an empty, bounded, shared FIFO buffer with n
slots */
5  void sbuf_init(sbuf_t *sp, int n)
6  {
7      sp->buf = Calloc(n, sizeof(int));
8      sp->n = n; /* Buffer holds
maxofnitems */
9      sp->front = sp->rear = 0; /* Empty buffer
iff front == rear */
10     Sem_init(&sp->mutex, 0, 1); /* Binary
semaphore for locking */
11     Sem_init(&sp->slots, 0, n); /* Initially,
buf has n empty slots */
12     Sem_init(&sp->items, 0, 0); /* Initially,
buf has zero data items */
13 }
14
15 /* Clean up buffer sp */
16 void sbuf_deinit(sbuf_t *sp)
17 {
18     Free(sp->buf);
19 }
20
21 /* Insert item onto the rear of shared buffer sp */

```

```

22     void sbuf_insert(sbuf_t *sp, int item)
23     {
24         P(&sp->slots);           /* Wait
for available slot */
25         P(&sp->mutex);           /* Lock
the buffer */
26         sp->buf[(++sp->rear)%(sp->n)] = item; /*
Insert the item */
27         V(&sp->mutex);           /*
Unlock the buffer */
28         V(&sp->items);           /*
Announce available item */
29     }
30
31     /* Remove and return the first item from buffer sp */
32     int sbuf_remove(sbuf_t *sp)
33     {
34         int item;
35         P(&sp->items);           /* Wait
for available item */
36         P(&sp->mutex);           /* Lock
the buffer */
37         item = sp->buf[(++sp->front)%(sp->n)]; /*
Remove the item */
38         V(&sp->mutex);           /*
Unlock the buffer */
39         V(&sp->slots);           /*
Announce available slot */

```




```
40         return item;
41     }
```


-----code/conc/sbuf.c

**Figure 12.25** `SBUF`: A package for synchronizing concurrent access to bounded buffers.


Readers-writers interactions occur frequently in real systems. For example, in an online airline reservation system, an unlimited number of customers are allowed to concurrently inspect the seat assignments, but a customer who is booking a seat must have exclusive access to the database. As another example, in a multithreaded caching Web proxy, an unlimited number of threads can fetch existing pages from the shared page cache, but any thread that writes a new page to the cache must have exclusive access.

The readers-writers problem has several variations, each based on the priorities of readers and writers. The *first readers-writers problem*, which favors readers, requires that no reader be kept waiting unless a writer has already been granted permission to use the object. In other words, no reader should wait simply because a writer is waiting. The *second readers-writers problem*, which favors writers, requires that once a writer is ready to write, it performs its write as soon as possible. Unlike the first problem, a reader that arrives after a writer must wait, even if the writer is also waiting.

**Figure 12.26**  shows a solution to the first readers-writers problem. Like the solutions to many synchronization problems, it is subtle and deceptively simple. The `w` semaphore controls access to the critical sections that access the shared object. The mutex semaphore protects access to the shared `readcnt` variable, which counts the number of readers currently in the critical section. A writer locks the mutex each time it enters the critical section and unlocks it each time it leaves. This guarantees that there is at most one writer in the critical section at any point in time. On the other hand, only the first reader to enter the critical section locks `w`, and only the last reader to leave the critical section unlocks it. The `w` mutex is ignored by readers who enter and leave while other readers are present. This means that as long as a single reader holds the `w` mutex, an unbounded number of readers can enter the critical section unimpeded.

A correct solution to either of the readers-writers problems can result in *starvation*, where a thread blocks indefinitely and fails to make progress. For example, in the solution in **Figure 12.26** , a writer could wait indefinitely while a stream of readers arrived.

## Practice Problem 12.10 (solution page [1038](#))

The solution to the first readers-writers problem in [Figure 12.26](#)  gives priority to readers, but this priority is weak in the sense that a writer leaving its critical section might restart a waiting writer instead of a waiting reader. Describe a scenario where this weak priority would allow a collection of writers to starve a reader.

## 12.5.5 Putting It Together: A Concurrent Server Based on Prethreading

We have seen how semaphores can be used to access shared variables and to schedule accesses to shared resources. To help you understand these ideas more clearly, let us apply them to a concurrent server based on a technique called *prethreading*.

```

|
/* Global variables */
int readcnt; /* Initially = 0 */
sem_t mutex, w; /* Both initially = 1 */
void reader(void)
{
    while (1) {
        P(&mutex);
        readcnt++;
        if (readcnt == 1) /* First in */
            P(&w);
        V(&mutex);
        /* Critical section */
        /* Reading happens */
        P(&mutex);
        readcnt--;
        if (readcnt == 0) /* Last out */
            V(&w);
        V(&mutex);
    }
}

void writer(void)
{
    while (1) {
        P(&w);
        /* Critical section */
        /* Writing happens */
        V(&w);
    }
}

```

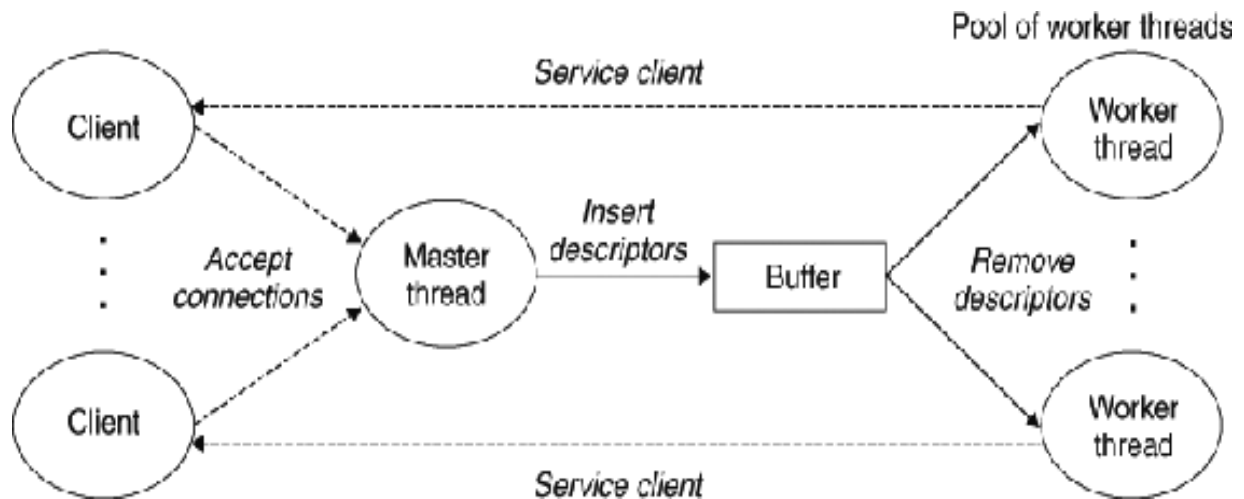
```
        }  
    }  
}
```

**Figure 12.26 Solution to the first readers-writers problem.**  
Favors readers over writers.

In the concurrent server in [Figure 12.14](#), we created a new thread for each new client. A disadvantage of this approach is that we incur the nontrivial cost of creating a new thread for each new client. A server based on prethreading tries to reduce this overhead by using the producer-consumer model shown in [Figure 12.27](#). The server consists of a main thread and a set of worker threads. The main thread repeatedly accepts connection requests from clients and places

## Aside Other synchronization mechanisms


We have shown you how to synchronize threads using semaphores, mainly because they are simple, classical, and have a clean semantic model. But you should know that other synchronization techniques exist as well. For example, Java threads are synchronized with a mechanism called a *Java monitor* [48], which provides a higher-level abstraction of the mutual exclusion and scheduling capabilities of semaphores; in fact, monitors can be implemented with semaphores. As another example, the Pthreads interface defines a set of synchronization operations on *mutex* and *condition* variables. Pthreads mutexes are used for mutual exclusion. Condition variables are used for scheduling accesses to shared resources, such as the bounded buffer in a producer-consumer program.



**Figure 12.27 Organization of a prethreaded concurrent server.**

A set of existing threads repeatedly remove and process connected descriptors from a bounded buffer.

the resulting connected descriptors in a bounded buffer. Each worker thread repeatedly removes a descriptor from the buffer, services the client, and then waits for the next descriptor.

**Figure 12.28**  shows how we would use the `SBUF` package to implement a prethreaded concurrent echo server. After initializing buffer `sbuf` (line 24), the main thread creates the set of worker threads (lines 25–26). Then it enters the infinite server loop, accepting connection requests and inserting the resulting connected descriptors in `sbuf`. Each worker thread has a very simple behavior. It waits until it is able to remove a connected descriptor from the buffer (line 39) and then calls the `echo_cnt` function to echo client input.



The `echo_cnt` function in [Figure 12.29](#) is a version of the `echo` function from [Figure 11.22](#) that records the cumulative number of bytes received from all clients in a global variable called `byte_cnt`. This is interesting code to study because it shows you a general technique for initializing packages that are called from thread routines. In our case, we need to initialize the `byte_cnt` counter and the `mutex` semaphore. One approach, which we used for the `SBUF` and `RIO` packages, is to require the main thread to explicitly call an initialization function. Another approach, shown here, uses the `pthread_once` function (line 19) to call

-----code/conc/echoserver-pre.c

```

1  #include "csapp.h"
2  #include "sbuf.h"
3  #define NTHREADS 4
4  #define SBUFSIZE 16
5
6  void echo_cnt(int connfd);
7  void *thread(void *vargp);
8
9  sbuf_t sbuf; /* Shared buffer of connected descriptors
*/
10
11 int main(int argc, char **argv)
12 {
13     int i, listenfd, connfd;
14     socklen_t clientlen;
15     struct sockaddr_storage clientaddr;
16     pthread_t tid;
17
18     if (argc != 2) {
19         fprintf(stderr, "usage: %s <port>\n",
argv[0]);
20         exit(0);
21     }
22     listenfd = Open_listenfd(argv[1]);
23
24     sbuf_init(&sbuf, SBUFSIZE);
25     for (i = 0; i < NTHREADS; i++) /* Create worker

```

```

threads */
26         Pthread_create(&tid, NULL, thread,
NULL);
27
28         while (1) {
29             clientlen = sizeof(struct
sockaddr_storage);
30             connfd = Accept(listenfd, (SA *)
&clientaddr, &clientlen);
31             sbuf_insert(&sbuf, connfd); /* Insert
connfd in buffer */
32         }
33     }
34
35     void *thread(void *vargp)
36     {
37         Pthread_detach(pthread_self());
38         while (1) {
39             int connfd = sbuf_remove(&sbuf);
/* Remove connfd from buffer */
40             echo_cnt(connfd);
/* Service client */
41             Close(connfd);
42         }
43     }

```

-----code/conc/echoservert-pre.c

**Figure 12.28 A prethreaded concurrent echo server.**

The server uses a producer-consumer model with one producer and multiple consumers.

-----code/conc/echo-cnt.c

```

1  #include "csapp.h"
2
3  static int byte_cnt;    /* Byte counter */
4  static sem_t mutex;    /* and the mutex that protects
it */
5
6  static void init_echo_cnt(void)
7  {
8      Sem_init(&mutex, 0, 1);
9      byte_cnt = 0;
10 }
11
12 void echo_cnt(int connfd)
13 {
14     int n;
15     char buf[MAXLINE];
16     rio_t rio;
17     static pthread_once_t once = PTHREAD_ONCE_INIT;
18
19     Pthread_once(&once, init_echo_cnt);
20     Rio_readinitb(&rio, connfd);
21     while((n = Rio_readlineb(&rio, buf, MAXLINE)) !=
0) {
22         P(&mutex);
23         byte_cnt += n;
24         printf("server received %d (%d total)
bytes on fd %d\n",

```

```
25         n, byte_cnt, connfd);
26         V(&mutex);
27         Rio_writen(connfd, buf, n);
28     }
29 }
```

-----code/conc/echo-cnt.c

**Figure 12.29** `echo_cnt`: A version of `echo` that counts all bytes received from clients.

the initialization function the first time some thread calls the `echo_cnt` function. The advantage of this approach is that it makes the package easier to use. The disadvantage is that every call to `echo_cnt` makes a call to `pthread_once`, which most times does nothing useful.

Once the package is initialized, the `echo_cnt` function initializes the `RIO` buffered I/O package (line 20) and then echoes each text line that is received from the client. Notice that the accesses to the shared `byte_cnt` variable in lines 23–25 are protected by *P* and *V* operations.



# Aside Event-driven programs based on threads

I/O multiplexing is not the only way to write an event-driven program. For example, you might have noticed that the concurrent prethreaded server that we just developed is really an event-driven server with simple state machines for the main and worker threads. The main thread has two states ("waiting for connection request" and "waiting for available buffer slot"), two I/O events ("connection request arrives" and "buffer slot becomes available"), and two transitions ("accept connection request" and "insert buffer item"). Similarly, each worker thread has one state ("waiting for available buffer item"), one I/O event ("buffer item becomes available"), and one transition ("remove buffer item").

All programs

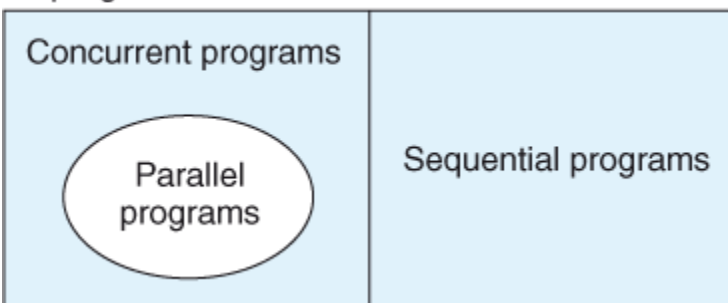



Figure 12.30 Relationships between the sets of sequential, concurrent, and parallel programs.

## 12.6 Using Threads for Parallelism

Thus far in our study of concurrency, we have assumed concurrent threads executing on uniprocessor systems. However, most modern machines have multi-core processors. Concurrent programs often run faster on such machines because the operating system kernel schedules the concurrent threads in parallel on multiple cores, rather than sequentially on a single core. Exploiting such parallelism is critically important in applications such as busy Web servers, database servers, and large scientific codes, and it is becoming increasingly useful in mainstream applications such as Web browsers, spreadsheets, and document processors.


**Figure 12.30**  shows the set relationships between sequential, concurrent, and parallel programs. The set of all programs can be partitioned into the disjoint sets of sequential and concurrent programs. A sequential program is written as a single logical flow. A concurrent program is written as multiple concurrent flows. A parallel program is a concurrent program running on multiple processors. Thus, the set of parallel programs is a proper subset of the set of concurrent programs.


A detailed treatment of parallel programs is beyond our scope, but studying a few simple example programs will help you understand

some important aspects of parallel programming. For example, consider how we might sum the sequence of integers  $0, \dots, n - 1$  in parallel. Of course, there is a closed-form solution for this particular problem, but nonetheless it is a concise and easy-to-understand exemplar that will allow us to make some interesting points about parallel programs.

The most straightforward approach for assigning work to different threads is to partition the sequence into  $t$  disjoint regions and then assign each of  $t$  different threads to work on its own region. For simplicity, assume that  $n$  is a multiple of  $t$ , such that each region has  $n/t$  elements. Let's look at some of the different ways that multiple threads might work on their assigned regions in parallel.


The simplest and most straightforward option is to have the threads sum into a shared global variable that is protected by a mutex.

**Figure 12.31**  shows how we might implement this. In lines 28–33, the main thread creates the peer threads and then waits for them to terminate. Notice that the main thread passes a small integer to each peer thread that serves as a unique thread ID. Each peer thread will use its thread ID to determine which portion of the sequence it should work on. This idea of passing a small unique thread ID to the peer threads is a general technique that is used in many parallel applications. After the peer threads have terminated, the global variable `gsum` contains the final sum. The main thread then uses the closed-form solution to verify the result (lines 36–37).

**Figure 12.32**  shows the function that each peer thread executes. In line 4, the thread extracts the thread ID from the thread argument and then uses this ID to determine the region of the sequence it should work on (lines 5–6). In lines 9–13, the thread iterates over its portion of the sequence, updating the shared global variable `gsum` on each iteration. Notice that we are careful to protect each update with  $P$  and  $V$  mutex operations.

When we run `psum-mutex` on a system with four cores on a sequence of size  $n = 2^{31}$  and measure its running time (in seconds) as a function of the number of threads, we get a nasty surprise:

Not only is the program extremely slow when it runs sequentially as a single thread, it is nearly an order of magnitude slower when it runs in parallel as multiple threads. And the performance gets worse as we add more cores. The reason for this poor performance is that the synchronization operations ( $P$  and  $V$ ) are very expensive relative to the cost of a single memory update. This highlights an important lesson about parallel programming: *Synchronization overhead is expensive and should be avoided if possible. If it cannot be avoided, the overhead should be amortized by as much useful computation as possible.*

One way to avoid synchronization in our example program is to have each peer thread compute its partial sum in a private variable that is not shared with any other thread, as shown in **Figure 12.33** . The main thread (not shown) defines a global array called `psum`, and each peer thread  $i$  accumulates its partial sum in `psum[i]`. Since we

are careful to give each peer thread a unique memory location to update, it is not necessary to protect these updates with mutexes. The only necessary synchronization is that the main thread must wait for all of the children to finish. After the peer threads have terminated, the main thread sums up the elements of the `psum` vector to arrive at the final result.

-----code/conc/psum-mutex.c

```

1  #include "csapp.h"
2  #define MAXTHREADS 32
3
4  void *sum_mutex(void *vargp); /* Thread routine */
5
6  /* Global shared variables */
7  long gsum = 0; /* Global sum */
8  long nelems_per_thread; /* Number of elements to sum */
9  sem_t mutex; /* Mutex to protect global sum
*/
10
11 int main(int argc, char **argv)
12 {
13     long i, nelems, log_nelems, nthreads,
myid[MAXTHREADS];
14     pthread_t tid[MAXTHREADS]; 15
16     /* Get input arguments */
17     if (argc != 3) {
18         printf("Usage: %s <nthreads>
<log_nelems>\n", argv[0]);
19         exit(0);
20     }
21     nthreads = atoi(argv[1]);
22     log_nelems = atoi(argv[2]);
23     nelems = (1L << log_nelems);
24     nelems_per_thread = nelems / nthreads;
25     sem_init(&mutex, 0, 1);

```

```

26
27     /* Create peer threads and wait for them to
finish */
28     for (i = 0; i < nthreads; i++) {
29         myid[i] = i;
30         Pthread_create(&tid[i], NULL, sum_mutex,
&myid[i]);
31     }
32     for (i = 0; i < nthreads; i++)
33         Pthread_join(tid[i], NULL);
34
35     /* Check final answer */
36     if (gsum != (nelems * (nelems-1))/2)
37         printf("Error: result=%ld\n", gsum); 38
39     exit(0);
40 }

```

-----code/conc/psum-mutex.c

**Figure 12.31 Main routine for `psum-mutex`.**

Uses multiple threads to sum the elements of a sequence into a shared global variable protected by a mutex.



-----code/conc/psum-mutex.c

```
1      /* Thread routine for psum-mutex.c */
2      void *sum_mutex(void *vargp)
3      {
4          long myid = *((long *)vargp); /*
Extract the thread ID */
5          long start = myid * nelems_per_thread; /* Start
element index */
6          long end = start + nelems_per_thread; /* End
element index */
7          long i;
8
9          for (i = start; i < end; i++) {
10             P(&mutex);
11             gsum += i;
12             V(&mutex);
13         }
14         return NULL;
15     }
```

-----code/conc/psum-mutex.c

**Figure 12.32 Thread routine for `psum-mutex`.**

Each peer thread sums into a shared global variable protected by a mutex.

-----code/conc/psum-array.c

```
|
1      /* Thread routine for psum-array.c */
2      void *sum_array(void *vargp)
3      {
4          long myid = *((long *)vargp);      /*
Extract the thread ID */
5          long start = myid * nelems_per_thread; /* Start
element index */
6          long end = start + nelems_per_thread; /* End
element index */
7          long i;
8
9          for (i = start; i < end; i++) {
10             psum[myid] += i;
11         }
12         return NULL;
13     }
```

-----code/conc/psum-array.c

**Figure 12.33 Thread routine for `psum-array`.**

Each peer thread accumulates its partial sum in a private array element that is not shared with any other peer thread.

When we run `psum-array` on our four-core system, we see that it runs orders of magnitude faster than `psum-mutex`:

In [Chapter 5](#), we learned how to use local variables to eliminate unnecessary memory references. [Figure 12.34](#) shows how we can apply this principle by having each peer thread accumulate its partial sum into a local variable rather than a global variable. When we run `psum-local` on our four-core machine, we get another order-of-magnitude decrease in running time:

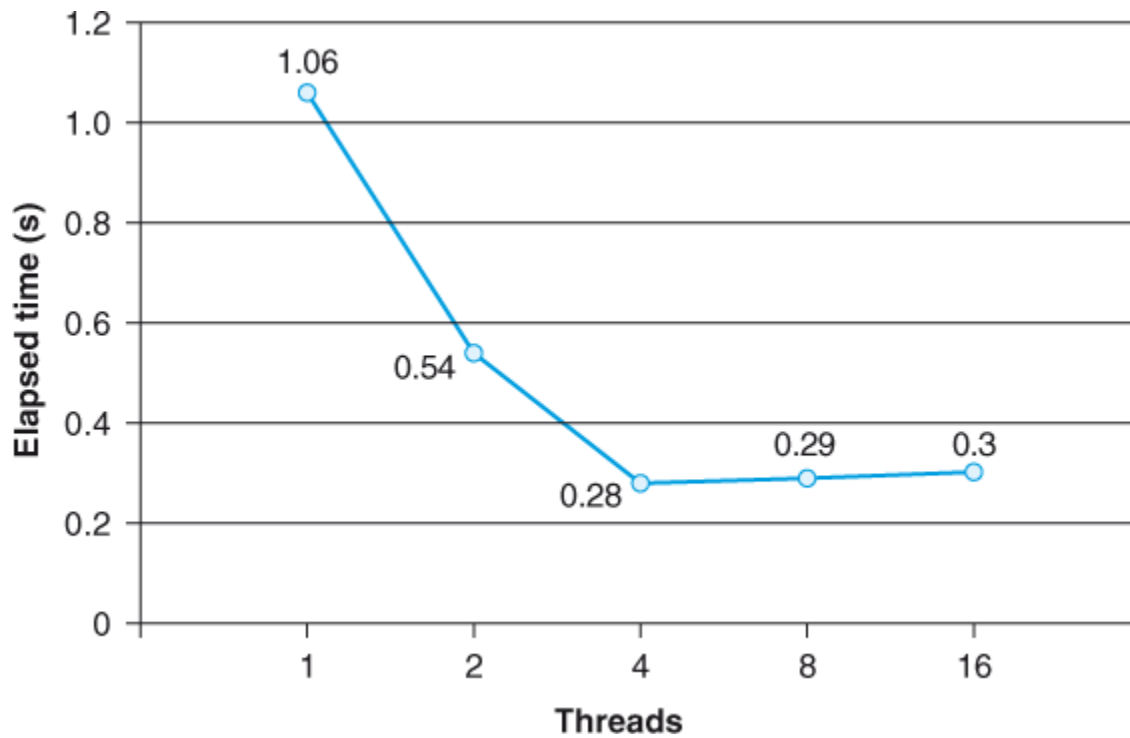
-----code/conc/psum-local.c

```
1      /* Thread routine for psum-local.c */
2      void *sum_local(void *vargp)
3      {
4          long myid = *((long *)vargp);      /*
Extract the thread ID */
5          long start = myid * nelems_per_thread; /* Start
element index */
6          long end = start + nelems_per_thread; /* End
element index */
7          long i, sum = 0;
8
9          for (i = start; i < end; i++) {
10             sum += i;
11         }
12         psum[myid] = sum;
13         return NULL;
14     }
```

-----code/conc/psum-local.c

**Figure 12.34** Thread routine for `psum-local`.



Each peer thread accumulates its partial sum in a local variable.



**Figure 12.35 Performance of `psum-local` (Figure 12.34 [□](#)).**  
Summing a sequence of  $2^{31}$  elements using four processor cores.

An important lesson to take away from this exercise is that writing parallel programs is tricky. Seemingly small changes to the code have a significant impact on performance.

# Characterizing the Performance of Parallel Programs

**Figure 12.35**  plots the total elapsed running time of the `psum-local` program in **Figure 12.34**  as a function of the number of threads. In each case, the program runs on a system with four processor cores and sums a sequence of  $n = 2^{31}$  elements. We see that running time decreases as we increase the number of threads, up to four threads, at which point it levels off and even starts to increase a little.

In the ideal case, we would expect the running time to decrease linearly with the number of cores. That is, we would expect running time to drop by half each time we double the number of threads. This is indeed the case until we reach the point ( $t > 4$ ) where each of the four cores is busy running at least one thread. Running time actually increases a bit as we increase the number of threads because of the overhead of context switching multiple threads on the same core. For this reason, parallel programs are often written so that each core runs exactly one thread.

Although absolute running time is the ultimate measure of any program's performance, there are some useful relative measures that can provide insight into how well a parallel program is exploiting potential parallelism. The *speedup* of a parallel program is typically defined as

$$S_p = \frac{T_1}{T_p}$$

where  $p$  is the number of processor cores and  $T_k$  is the running time on  $k$  cores. This formulation is sometimes referred to as *strong scaling*. When  $T_1$  is the execution


**Figure 12.36 Speedup and parallel efficiency for the execution times in Figure 12.35 .**

time of a sequential version of the program, then  $S_p$  is called the *absolute speedup*. When  $T_1$  is the execution time of the parallel version of the program running on one core, then  $S_p$  is called the *relative speedup*. Absolute speedup is a truer measure of the benefits of parallelism than relative speedup. Parallel programs often suffer from synchronization overheads, even when they run on one processor, and these overheads can artificially inflate the relative speedup numbers because they increase the size of the numerator. On the other hand, absolute speedup is more difficult to measure than relative speedup because measuring absolute speedup requires two different versions of the program. For complex parallel codes, creating a separate sequential version might not be feasible, either because the code is too complex or because the source code is not available.

A related measure, known as *efficiency*, is defined as

$$E_p = \frac{S_p}{p} = \frac{T_1}{pT_p}$$

and is typically reported as a percentage in the range (0, 100]. Efficiency is a measure of the overhead due to parallelization. Programs with high efficiency are spending more time doing useful work and less time synchronizing and communicating than programs with low efficiency.

**Figure 12.36**  shows the different speedup and efficiency measures for our example parallel sum program. Efficiencies over 90 percent such as these are very good, but do not be fooled. We were able to achieve high efficiency because our problem was trivially easy to parallelize. In practice, this is not usually the case. Parallel programming has been an active area of research for decades. With the advent of commodity multi-core machines whose core count is doubling every few years, parallel programming continues to be a deep, difficult, and active area of research.

There is another view of speedup, known as *weak scaling*, which increases the problem size along with the number of processors, such that the amount of work performed on each processor is held constant as the number of processors increases. With this formulation, speedup and efficiency are expressed in terms of the total amount of work accomplished per unit time. For example, if we can double the number of processors and do twice the amount of work per hour, then we are enjoying linear speedup and 100 percent efficiency.



Weak scaling is often a truer measure than strong scaling because it more accurately reflects our desire to use bigger machines to do more work. This is particularly true for scientific codes, where the problem size can be easily increased and where bigger problem sizes translate directly to better predictions of nature. However, there exist applications whose sizes are not so easily increased, and for these applications strong scaling is more appropriate. For example, the amount of work performed by real-time signal-processing applications is often determined by the properties of the physical sensors that are generating the signals. Changing the total amount of work requires using different physical sensors, which might not be feasible or necessary. For these applications, we typically want to use parallelism to accomplish a fixed amount of work as quickly as possible.

## Practice Problem 12.11 (solution page [1038](#))

Fill in the blanks for the parallel program in the following table. Assume strong scaling.

[OceanofPDF.com](http://OceanofPDF.com)

## 12.7 Other Concurrency Issues


You probably noticed that life got much more complicated once we were asked to synchronize accesses to shared data. So far, we have looked at techniques for mutual exclusion and producer-consumer synchronization, but this is only the tip of the iceberg.

Synchronization is a fundamentally difficult problem that raises issues that simply do not arise in ordinary sequential programs. This section is a survey (by no means complete) of some of the issues you need to be aware of when you write concurrent programs. To keep things concrete, we will couch our discussion in terms of threads. Keep in mind, however, that these are typical of the issues that arise when concurrent flows of any kind manipulate shared resources.

## 12.7.1 Thread Safety

When we program with threads, we must be careful to write functions that have a property called thread safety. A function is said to be *thread-safe* if and only if it will always produce correct results when called repeatedly from multiple concurrent threads. If a function is not thread-safe, then we say it is *thread-unsafe*.

We can identify four (nondisjoint) classes of thread-unsafe functions:

**Class 1:** *Functions that do not protect shared variables.* We have already encountered this problem with the thread function in [Figure 12.16](#) , which

-----code/conc/rand.c

```
|
1     unsigned next_seed = 1;
2
3     /* rand - return pseudorandom integer in the range
0..32767 */
4     unsigned rand(void)
5     {
6         next_seed = next_seed*1103515245 + 12543;
7         return (unsigned)(next_seed>>16) % 32768;
8     }
9
10    /* srand - set the initial seed for rand() */
11    void srand(unsigned new_seed)
12    {
13        next_seed = new_seed;
14    }
```


-----code/conc/rand.c

**Figure 12.37** A thread-unsafe pseudorandom number generator.

(Based on [61])

increments an unprotected global counter variable. This class of thread-unsafe functions is relatively easy to make thread-safe: protect the shared variables with synchronization operations such

as  $P$  and  $V$ . An advantage is that it does not require any changes in the calling program. A disadvantage is that the synchronization operations slow down the function.

**Class 2:** *Functions that keep state across multiple invocations.* A pseudorandom number generator is a simple example of this class of thread-unsafe functions. Consider the pseudorandom number generator package in [Figure 12.37](#) .

The `rand` function is thread-unsafe because the result of the current invocation depends on an intermediate result from the previous iteration. When we call `rand` repeatedly from a single thread after seeding it with a call to `srand`, we can expect a repeatable sequence of numbers. However, this assumption no longer holds if multiple threads are calling `rand`.

The only way to make a function such as `rand` thread-safe is to rewrite it so that it does not use any `static` data, relying instead on the caller to pass the state information in arguments. The disadvantage is that the programmer is now forced to change the code in the calling routine as well. In a large program where there are potentially hundreds of different call sites, making such modifications could be nontrivial and prone to error.

**Class 3:** *Functions that return a pointer to a static variable.* Some functions, such as `ctime` and `gethostbyname`, compute a result in a `static` variable and then return a pointer to that variable. If we call such functions from

-----code/conc/ctime-ts.c

```
|
1 char *ctime_ts(const time_t *timep, char *privatep)
2 {
3     char *sharedp;
4
5     P(&mutex);
6     sharedp = ctime(timep);
7     strcpy(privatep, sharedp); /* Copy string
from shared to private */
8     V(&mutex);
9     return privatep;
10 }
```

-----code/conc/ctime-ts.c

**Figure 12.38 Thread-safe wrapper function for the C standard library `ctime` function.**

This example uses the lock-and-copy technique to call a class 3 thread-unsafe function.

concurrent threads, then disaster is likely, as results being used by one thread are silently overwritten by another thread.

There are two ways to deal with this class of thread-unsafe functions. One option is to rewrite the function so that the caller passes the address of the variable in which to store the results.

This eliminates all shared data, but it requires the programmer to have access to the function source code.

If the thread-unsafe function is difficult or impossible to modify (e.g., the code is very complex or there is no source code available), then another option is to use the *lock-and-copy* technique. The basic idea is to associate a mutex with the thread-unsafe function. At each call site, lock the mutex, call the thread-unsafe function, copy the result returned by the function to a private memory location, and then unlock the mutex. To minimize changes to the caller, you should define a thread-safe wrapper function that performs the lock-and-copy and then replace all calls to the thread-unsafe function with calls to the wrapper. For example, [Figure 12.38](#) shows a thread-safe wrapper for `ctime` that uses the lock-and-copy technique.

**Class 4:** *Functions that call thread-unsafe functions.* If a function  $f$  calls a thread-unsafe function  $g$ , is  $f$  thread-unsafe? It depends. If  $g$  is a class 2 function that relies on state across multiple invocations, then  $f$  is also thread-unsafe and there is no recourse short of rewriting  $g$ . However, if  $g$  is a class 1 or class 3 function, then  $f$  can still be thread-safe if you protect the call site and any resulting shared data with a mutex. We see a good example of this in [Figure 12.38](#), where we use lock-and-copy to write a thread-safe function that calls a thread-unsafe function.

All functions



Figure 12.39 Relationships between the sets of reentrant, thread-safe, and thread-unsafe functions.

-----code/conc/rand-r.c


```
|
1      /* rand_r - return a pseudorandom integer on 0..32767 */
2      int rand_r(unsigned int *nextp)
3      {
4          *nextp = *nextp * 1103515245 + 12345;
5          return (unsigned int)(*nextp / 65536) % 32768;
6      }
```



-----code/conc/rand-r.c

Figure 12.40 `rand_r`: A reentrant version of the `rand` function from Figure 12.37 [□](#).




## 12.7.2 Reentrancy

There is an important class of thread-safe functions, known as *reentrant functions*, that are characterized by the property that they do not reference *any* shared data when they are called by multiple threads. Although the terms *thread-safe* and *reentrant* are sometimes used (incorrectly) as synonyms, there is a clear technical distinction that is worth preserving. [Figure 12.39](#)  shows the set relationships between reentrant, thread-safe, and thread-unsafe functions. The set of all functions is partitioned into the disjoint sets of thread-safe and thread-unsafe functions. The set of reentrant functions is a proper subset of the thread-safe functions.

Reentrant functions are typically more efficient than non-reentrant thread-safe functions because they require no synchronization operations. Furthermore, the only way to convert a class 2 thread-unsafe function into a thread-safe one is to rewrite it so that it is reentrant. For example, [Figure 12.40](#)  shows a reentrant version of the `rand` function from [Figure 12.37](#) . The key idea is that we have replaced the static `next` variable with a pointer that is passed in by the caller.

Is it possible to inspect the code of some function and declare a priori that it is reentrant? Unfortunately, it depends. If all function arguments are passed by value (i.e., no pointers) and all data references are to local automatic stack variables (i.e., no references to static or global variables), then the function is *explicitly reentrant*,

in the sense that we can assert its reentrancy regardless of how it is called.

However, if we loosen our assumptions a bit and allow some parameters in our otherwise explicitly reentrant function to be passed by reference (i.e., we allow them to pass pointers), then we have an *implicitly reentrant* function, in the sense that it is only reentrant if the calling threads are careful to pass pointers to nonshared data. For example, the `rand_r` function in [Figure 12.40](#)  is implicitly reentrant.

We always use the term *reentrant* to include both explicit and implicit reentrant functions. However, it is important to realize that reentrancy is sometimes a property of both the caller and the callee, and not just the callee alone.

## *Practice Problem 12.12 (solution page **1038**)*

The `ctime_ts` function in [Figure 12.38](#)  is thread-safe but not reentrant. Explain.

## 12.7.3 Using Existing Library Functions in Threaded Programs


Most Linux functions, including the functions defined in the standard C library (such as `malloc`, `free`, `realloc`, `printf`, and `scanf`), are thread-safe, with only a few exceptions. [Figure 12.41](#) lists some common exceptions. (See [\[110\]](#) for a complete list.) The `strtok` function is a deprecated function (one whose use is discouraged) for parsing strings. The `asctime`, `ctime`, and `localtime` functions are popular functions for converting back and forth between different time and date formats. The `gethostbyaddr`, `gethostbyname`, and `inet_ntoa` functions are obsolete network programming functions that have been replaced by the reentrant `getaddrinfo`, `getnameinfo`, and `inet_ntop` functions, respectively (see [Chapter 11](#)). With the exceptions of `rand` and `strtok`, they are of the class 3 variety that return a pointer to a static variable. If we need to call one of these functions in a threaded program, the least disruptive approach to the caller is to lock and copy. However, the lock-and-copy approach has a number of disadvantages. First, the additional synchronization slows down the program. Second, functions that return pointers to complex structures of structures require a *deep copy* of the structures in order to copy the entire structure hierarchy. Third, the lock-and-copy approach will not work for a class 2 thread-unsafe function such as `rand` that relies on static state across calls.

## Figure 12.41 Common thread-unsafe library functions.

Therefore, Linux systems provide reentrant versions of most thread-unsafe functions. The names of the reentrant versions always end with the `_r` suffix. For example, the reentrant version of `asctime` is called `asctime_r`. We recommend using these functions whenever possible.

## 12.7.4 Races

A *race* occurs when the correctness of a program depends on one thread reaching point  $x$  in its control flow before another thread reaches point  $y$ . Races usually occur because programmers assume that threads will take some particular trajectory through the execution state space, forgetting the golden rule that threaded programs must work correctly for any feasible trajectory.

An example is the easiest way to understand the nature of races. Consider the simple program in [Figure 12.42](#) . The main thread creates four peer threads and passes a pointer to a unique integer ID to each one. Each peer thread copies the

-----code/conc/race.c

```
|
1      /* WARNING: This code is buggy! */
2      #include "csapp.h"
3      #define N 4
4
5      void *thread(void *vargp);
6
7      int main()
8      {
9          pthread_t tid[N];
10         int i;
11
12         for (i = 0; i < N; i++)
13             Pthread_create(&tid[i], NULL, thread,
14 &i);
15         for (i = 0; i < N; i++)
16             Pthread_join(tid[i], NULL);
17         exit(0);
18
19         /* Thread routine */
20         void *thread(void *vargp)
21         {
22             int myid = *((int *)vargp);
23             printf("Hello from thread %d\n", myid);
24             return NULL;
25         }
```

-----code/conc/race.c

### Figure 12.42 program with a race.

ID passed in its argument to a local variable (line 22) and then prints a message containing the ID. It looks simple enough, but when we run this program on our system, we get the following incorrect result:

```
linux> ./race
Hello from thread 1
Hello from thread 3
Hello from thread 2
Hello from thread 3
```

The problem is caused by a race between each peer thread and the main thread. Can you spot the race? Here is what happens. When the main thread creates a peer thread in line 13, it passes a pointer to the local stack variable `i`. At this point, the race is on between the next increment of `i` in line 12 and the dereferencing and assignment of the argument in line 22. If the peer thread executes line 22 before the main thread increments `i` in line 12, then the `myid` variable gets the correct ID. Otherwise, it will contain the ID of some other thread. The scary thing is that whether we get the correct answer depends on how the kernel schedules the execution of the threads. On our system it fails, but on other systems it might work correctly, leaving the programmer blissfully unaware of a serious bug.



To eliminate the race, we can dynamically allocate a separate block for each integer ID and pass the thread routine a pointer to this block, as shown in [Figure 12.43](#) (lines 12–14). Notice that the thread routine must free the block in order to avoid a memory leak.


When we run this program on our system, we now get the correct result:

```
linux> ./norace
Hello from thread 0
Hello from thread 1
Hello from thread 2
Hello from thread 3
```

## *Practice Problem 12.13 (solution page **1039**)*

In [Figure 12.43](#), we might be tempted to free the allocated memory block immediately after line 14 in the main thread, instead of freeing it in the peer thread. But this would be a bad idea. Why?

## *Practice Problem 12.14 (solution page 1039)*

1. In **Figure 12.43** , we eliminated the race by allocating a separate block for each integer ID. Outline a different approach that does not call the `malloc` or `free` functions.
2. What are the advantages and disadvantages of this approach?

-----code/conc/norace.c

```

1  #include "csapp.h"
2  #define N 4
3
4  void *thread(void *vargp);
5
6  int main()
7  {
8      pthread_t tid[N];
9      int i, *ptr;
10
11     for (i = 0; i < N; i++) {
12         ptr = Malloc(sizeof(int));
13         *ptr = i;
14         Pthread_create(&tid[i], NULL, thread,
ptr);
15     }
16     for (i = 0; i < N; i++)
17         Pthread_join(tid[i], NULL);
18     exit(0);
19 }
20
21 /* Thread routine */
22 void *thread(void *vargp)
23 {
24     int myid = *((int *)vargp);
25     Free(vargp);
26     printf("Hello from thread %d\n", myid);

```


```
27         return NULL;  
28     }
```

-----code/conc/norace.c

### Figure 12.43

A correct version of the program in [Figure 12.42](#)  without a race.


## 12.7.5 Deadlocks


Semaphores introduce the potential for a nasty kind of run-time error, called *deadlock*, where a collection of threads is blocked, waiting for a condition that will never be true. The progress graph is an invaluable tool for understanding deadlock. For example, [Figure 12.44](#)  shows the progress graph for a pair of threads that use two semaphores for mutual exclusion. From this graph, we can glean some important insights about deadlock:

- The programmer has incorrectly ordered the  $P$  and  $V$  operations such that the forbidden regions for the two semaphores overlap. If some execution trajectory happens to reach the *deadlock state*  $d$ , then no further progress is



deadlock region, then deadlock is inevitable. Trajectories can enter deadlock regions, but they can never leave.

- Deadlock is an especially difficult issue because it is not always predictable. Some lucky execution trajectories will skirt the deadlock region, while others will be trapped by it. **Figure 12.44**  shows an example of each. The implications for a programmer are scary. You might run the same program a thousand times without any problem, but then the next time it deadlocks. Or the program might work fine on one machine but deadlock on another. Worst of all, the error is often not repeatable because different executions have different trajectories.

Programs deadlock for many reasons, and preventing them is a difficult problem in general. However, when binary semaphores are used for mutual exclusion, as in **Figure 12.44** , then you can apply the following simple and effective rule to prevent deadlocks:



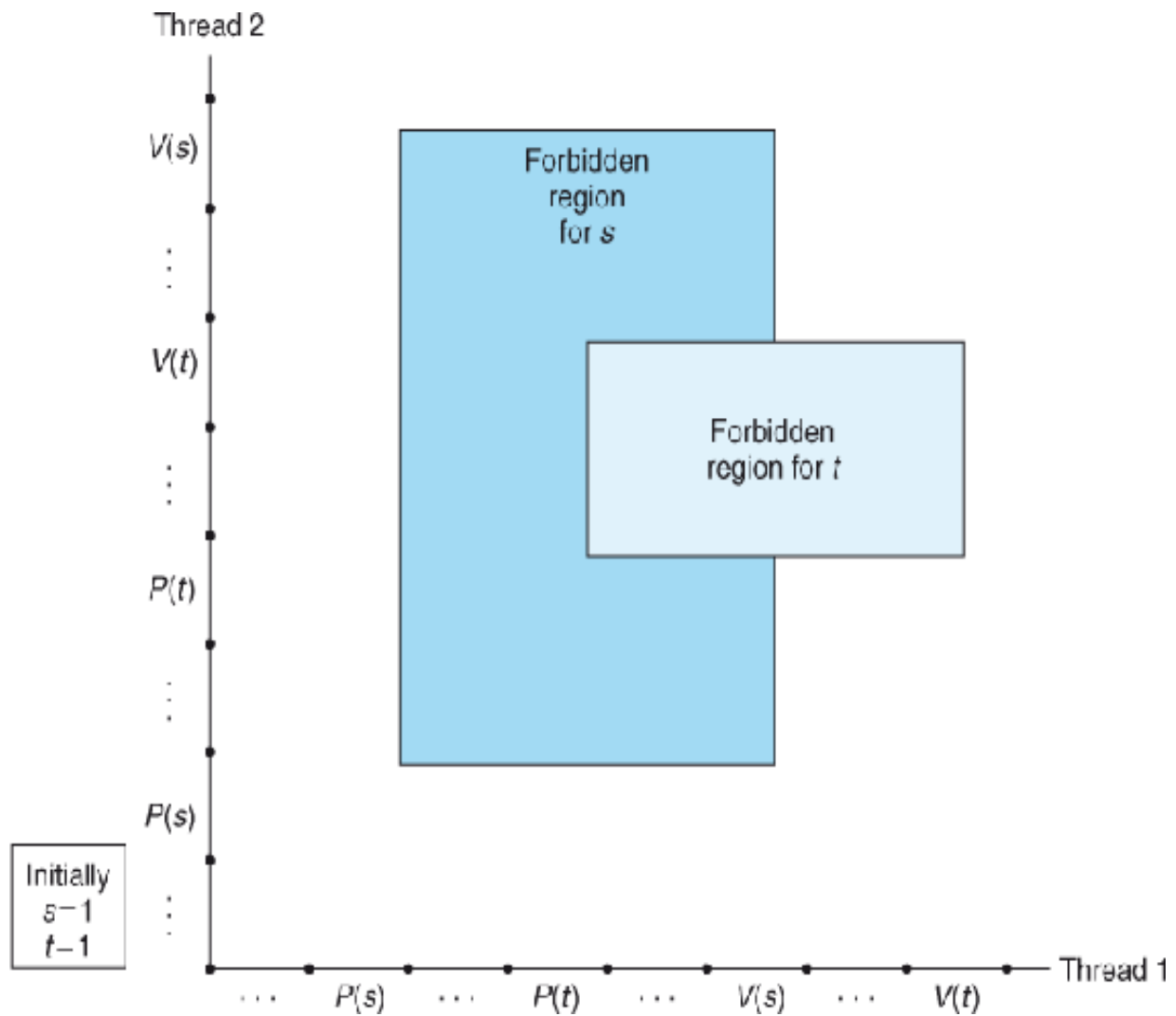


Figure 12.45 Progress graph for a deadlock-free program.

**Mutex lock ordering rule:** Given a total ordering of all mutexes, a program is deadlock-free if each thread acquires its mutexes in order and releases them in reverse order.

For example, we can fix the deadlock in [Figure 12.44](#) by locking  $s$  first, then  $t$ , in each thread. [Figure 12.45](#) shows the resulting progress graph.

## Practice Problem 12.15 (solution page 1039)

Consider the following program, which attempts to use a pair of semaphores for mutual exclusion.

```
Initially: s = 1, t = 0.
```

Thread 1:	Thread 2:
P(s);	P(s);
V(s);	V(s);
P(t);	P(t);
V(t);	V(t);

- Draw the progress graph for this program.
- Does it always deadlock?
- If so, what simple change to the initial semaphore values will eliminate the potential for deadlock?
- Draw the progress graph for the resulting deadlock-free program.

## 12.8 Summary

A concurrent program consists of a collection of logical flows that overlap in time. In this chapter, we have studied three different mechanisms for building concurrent programs: processes, I/O multiplexing, and threads. We used a concurrent network server as the motivating application throughout.

Processes are scheduled automatically by the kernel, and because of their separate virtual address spaces, they require explicit IPC mechanisms in order to share data. Event-driven programs create their own concurrent logical flows, which are modeled as state machines, and use I/O multiplexing to explicitly schedule the flows. Because the program runs in a single process, sharing data between flows is fast and easy. Threads are a hybrid of these approaches. Like flows based on processes, threads are scheduled automatically by the kernel. Like flows based on I/O multiplexing, threads run in the context of a single process, and thus can share data quickly and easily.

Regardless of the concurrency mechanism, synchronizing concurrent accesses to shared data is a difficult problem. The *P* and *V* operations on semaphores have been developed to help deal with this problem. Semaphore operations can be used to provide mutually exclusive access to shared data, as well as to schedule access to resources such as the bounded buffers in producer-consumer

systems and shared objects in readers-writers systems. A concurrent prethreaded echo server provides a compelling example of these usage scenarios for semaphores.

Concurrency introduces other difficult issues as well. Functions that are called by threads must have a property known as thread safety. We have identified four classes of thread-unsafe functions, along with suggestions for making them thread-safe. Reentrant functions are the proper subset of thread-safe functions that do not access any shared data. Reentrant functions are often more efficient than non-reentrant functions because they do not require any synchronization primitives. Some other difficult issues that arise in concurrent programs are races and dead locks. Races occur when programmers make incorrect assumptions about how logical flows are scheduled. Deadlocks occur when a flow is waiting for an event that will never happen.

[OceanofPDF.com](http://OceanofPDF.com)

# Bibliographic Notes


Semaphore operations were introduced by Dijkstra [31]. The progress graph concept was introduced by Coffman [23] and later formalized by Carson and Reynolds [16]. The readers-writers problem was introduced by Courtois et al [25]. Operating systems texts describe classical synchronization problems such as the dining philosophers, sleeping barber, and cigarette smokers problems in more detail [102, 106, 113]. The book by Butenhof [15] is a comprehensive description of the Posix threads interface. The paper by Birrell [7] is an excellent introduction to threads programming and its pitfalls. The book by Reinders [90] describes a C/C++ library that simplifies the design and implementation of threaded programs. Several texts cover the fundamentals of parallel programming on multi-core systems [47, 71]. Pugh identifies weaknesses with the way that Java threads interact through memory and proposes replacement memory models [88]. Gustafson proposed the weak-scaling speedup model [43] as an alternative to strong scaling.

# Homework Problems

## 12.16 ♦

Write a version of `hello.c` ([Figure 12.13](#)) that creates and reaps  $n$  joinable peer threads, where  $n$  is a command-line argument.

## 12.17 ♦

- A. The program in [Figure 12.46](#)  has a bug. The thread is supposed to sleep for 1 second and then print a string. However, when we run it on our system, nothing prints. Why?
- B. You can fix this bug by replacing the exit function in line 10 with one of two different Pthreads function calls. Which ones?

-----code/conc/hellobug.c

```
1  /* WARNING: This code is buggy! */
2  #include "csapp.h"
3  void *thread(void *vargp);
4
5  int main()
6  {
7      pthread_t tid;
8
9      Pthread_create(&tid, NULL, thread, NULL);
10     exit(0);
11 }
12
13 /* Thread routine */
14 void *thread(void *vargp)
15 {
16     Sleep(1);
17     printf("Hello, world!\n");
18     return NULL;
19 }
```

-----code/conc/hellobug.c

Figure 12.46 Buggy program for [Problem 12.17](#) .



## 12.18

Using the progress graph in [Figure 12.21](#), classify the following trajectories as either safe or unsafe.

A.  $H_2, L_2, U_2, H_1, L_1, S_2, U_1, S_1, T_1, T_2$

B.  $H_2, H_1, L_1, U_1, S_1, L_2, T_1, U_2, S_2, T_2$

C.  $H_1, L_1, H_2, L_2, U_2, S_2, U_1, S_1, T_1, T_2$

## 12.19 ♦♦

The solution to the first readers-writers problem in [Figure 12.26](#) gives a somewhat weak priority to readers because a writer leaving its critical section might restart a waiting writer instead of a waiting reader. Derive a solution that gives stronger priority to readers, where a writer leaving its critical section will always restart a waiting reader if one exists.

## 12.20 ◆◆◆

Consider a simpler variant of the readers-writers problem where there are at most  $N$  readers. Derive a solution that gives equal priority to readers and writers, in the sense that pending readers and writers have an equal chance of being granted access to the resource. *Hint:* You can solve this problem using a single counting semaphore and a single mutex.

## 12.21 ◆◆◆◆

Derive a solution to the second readers-writers problem, which favors writers instead of readers.

## 12.22 ◆◆

Test your understanding of the `select` function by modifying the server in [Figure 12.6](#) so that it echoes at most one text line per iteration of the main server loop.

## 12.23 ♦♦

The event-driven concurrent echo server in [Figure 12.8](#) is flawed because a malicious client can deny service to other clients by sending a partial text line. Write an improved version of the server that can handle these partial text lines without blocking.

## 12.24 ♦

The functions in the `RIO` I/O package ([Section 10.5](#)) are thread-safe. Are they reentrant as well?

## 12.25 ♦

In the prethreaded concurrent echo server in [Figure 12.28](#), each thread calls the `echo_cnt` function ([Figure 12.29](#)). Is `echo_cnt` thread-safe? Is it reentrant? Why or why not?

## 12.26 ◆◆◆

Use the lock-and-copy technique to implement a thread-safe non-reentrant version of `gethostbyname` called `gethostbyname_ts`. A correct solution will use a deep copy of the `hostent` structure protected by a mutex.

## 12.27 ♦♦

Some network programming texts suggest the following approach for reading and writing sockets: Before interacting with the client, open two standard I/O streams on the same open connected socket descriptor, one for reading and one for writing:

```
FILE *fpin, *fpout;
```

```
|  
fpin = fdopen(sockfd, "r");  
fpout = fdopen(sockfd, "w");
```

When the server finishes interacting with the client, close both streams as follows:

```
fclose(fpin);  
fclose(fpout);
```

However, if you try this approach in a concurrent server based on threads, you will create a deadly race condition. Explain.

## 12.28 ♦

In [Figure 12.45](#), does swapping the order of the two  $V$  operations have any effect on whether or not the program deadlocks? Justify your answer by drawing the progress graphs for the four possible cases:

## 12.29 ♦

Can the following program deadlock? Why or why not?

```
Initially: a = 1, b = 1, c = 1.
```

Thread 1:	Thread 2:
P(a);	P(c);
P(b);	P(b);
V(b);	V(b);
P(c);	V(c);
V(c);	
V(a);	

## 12.30 ♦


Consider the following program that deadlocks.

```
Initially: a = 1, b = 1, c = 1.
```

Thread 1:	Thread 2:	Thread 3:
P(a);	P(c);	P(c);
P(b);	P(b);	V(c);
V(b);	V(b);	P(b);
P(c);	V(c);	P(a);
V(c);	P(a);	V(a);
V(a);	V(a);	V(b);

- For each thread, list the pairs of mutexes that it holds simultaneously.
- If  $a < b < c$ , which threads violate the mutex lock ordering rule?
- For these threads, show a new lock ordering that guarantees freedom from deadlock.

## 12.31 ◆◆◆

Implement a version of the standard I/O `fgets` function, called `tfgets`, that times out and returns `NULL` if it does not receive an input line on standard input within 5 seconds. Your function should be implemented in a package called `tfgets-proc.c` using processes, signals, and nonlocal jumps. It should not use the Linux `alarm` function. Test your solution using the driver program in [Figure 12.47](#) .



-----code/conc/tfgets-main.c

```
|
1  #include "csapp.h"
2
3  char *tfgets(char *s, int size, FILE *stream);
4
5  int main()
6  {
7      char buf[MAXLINE];
8
9      if (tfgets(buf, MAXLINE, stdin) == NULL)
10         printf("BOOM!\n");
11     else
12         printf("%s", buf);
13
14     exit(0);
15 }
```

-----code/conc/tfgets-main.c

**Figure 12.47** Driver program for Problems 12.31–12.33.

## 12.32 ◆◆◆

Implement a version of the `tfgets` function from [Problem 12.31](#) that uses the `select` function. Your function should be implemented in a package called `tfgets-select.c`. Test your solution using the driver program from [Problem 12.31](#). You may assume that standard input is assigned to descriptor 0.

## 12.33 ◆◆◆

Implement a threaded version of the `tfgets` function from [Problem 12.31](#). Your function should be implemented in a package called `tfgets-thread.c`. Test your solution using the driver program from [Problem 12.31](#).

## 12.34 ◆◆◆

Write a parallel threaded version of an  $N \times M$  matrix multiplication kernel. Compare the performance to the sequential case.

## 12.35 ◆◆◆

Implement a concurrent version of the TINY Web server based on processes. Your solution should create a new child process for each new connection request. Test your solution using a real Web browser.

## 12.36 ◆◆◆

Implement a concurrent version of the TINY Web server based on I/O multiplexing. Test your solution using a real Web browser.

## 12.37 ◆◆◆

Implement a concurrent version of the TINY Web server based on threads. Your solution should create a new thread for each new connection request. Test your solution using a real Web browser.

## 12.38 ◆◆◆◆

Implement a concurrent prethreaded version of the TINY Web server. Your solution should dynamically increase or decrease the number of threads in response to the current load. One strategy is to double the number of threads when the buffer becomes full, and halve the number of threads when the buffer becomes empty. Test your solution using a real Web browser.

## 12.39 ◆◆◆◆

A Web proxy is a program that acts as a middleman between a Web server and browser. Instead of contacting the server directly to get a Web page, the browser contacts the proxy, which forwards the request to the server. When the server replies to the proxy, the proxy sends the reply to the browser. For this lab, you will write a simple Web proxy that filters and logs requests:

- A. In the first part of the lab, you will set up the proxy to accept requests, parse the HTTP, forward the requests to the server, and return the results to the browser. Your proxy should log the URLs of all requests in a log file on disk, and it should also block requests to any URL contained in a filter file on disk.
- B. In the second part of the lab, you will upgrade your proxy to deal with multiple open connections at once by spawning a separate thread to handle each request. While your proxy is waiting for a remote server to respond to a request so that it can serve one browser, it should be working on a pending request from another browser.

Check your proxy solution using a real Web browser.

# Solutions to Practice Problems

## **Solution to Problem 12.1** [↗](#)(page 975)

When the parent forks the child, it gets a copy of the connected descriptor, and the reference count for the associated file table is incremented from 1 to 2. When the parent closes its copy of the descriptor, the reference count is decremented from 2 to 1. Since the kernel will not close a file until the reference counter in its file table goes to 0, the child's end of the connection stays open.

## **Solution to Problem 12.2** [↗](#)(page 975)

When a process terminates for any reason, the kernel closes all open descriptors. Thus, the child's copy of the connected file descriptor will be closed automatically when the child exits.

## Solution to Problem 12.3 [↗](#)(page 980)

Recall that a descriptor is ready for reading if a request to read 1 byte from that descriptor would not block. If EOF becomes true on a descriptor, then the descriptor is ready for reading because the read operation will return immediately with a zero return code indicating EOF. Thus, typing Ctrl+D causes the `select` function to return with descriptor 0 in the ready set.

## Solution to Problem 12.4 [↗](#)(page 984)

We reinitialize the `pool.ready_set` variable before every call to `select` because it serves as both an input and output argument. On input, it contains the read set. On output, it contains the ready set.

## Solution to Problem 12.5 (page 992)

Since threads run in the same process, they all share the same descriptor table. No matter how many threads use the connected descriptor, the reference count for the connected descriptor's file table is equal to 1. Thus, a single `close` operation is sufficient to free the memory resources associated with the connected descriptor when we are through with it.



# Solution to Problem 12.6 (page 995)

The main idea here is that stack variables are private, whereas global and static variables are shared. Static variables such as `cnt` are a little tricky because the sharing is limited to the functions within their scope—in this case, the thread routine.

A. Here is the table:

Notes:

`ptr` A global variable that is written by the main thread and read by the peer threads.

`cnt` A static variable with only one instance in memory that is read and written by the two peer threads.

`i.m` A local automatic variable stored on the stack of the main thread. Even though its value is passed to the peer threads, the peer threads never reference it on the stack, and thus it is not shared.

`msgs.m` A local automatic variable stored on the main thread's stack and referenced indirectly through `ptr` by both peer threads.

`myid.p0` and `myid.p1` Instances of a local automatic variable residing on the stacks of peer threads 0 and 1,

respectively.

B. Variables `ptr`, `cnt`, and `msgs` are referenced by more than one thread and thus are shared.

## Solution to Problem 12.7 (page 998)

The important idea here is that you cannot make any assumptions about the ordering that the kernel chooses when it schedules your threads.

Variable `cnt` has a final incorrect value of 1.

## Solution to Problem 12.8 (page 1001)

This problem is a simple test of your understanding of safe and unsafe trajectories in progress graphs. Trajectories such as A and C that skirt the critical region are safe and will produce correct results.

A.  $H_1, L_1, U_1, S_1, H_2, L_2, U_2, S_2, T_2, T_1$ : safe

B.  $H_2, L_2, H_1, L_1, U_1, S_1, T_1, U_2, S_2, T_2$ : unsafe

C.  $H_1, H_2, L_2, U_2, S_2, L_1, U_1, S_1, T_1, T_2$ : safe

# Solution to Problem 12.9 (page 1006)

- A.  $p = 1, c = 1, n > 1$ : Yes, the mutex semaphore is necessary because the producer and consumer can concurrently access the buffer.
- B.  $p = 1, c = 1, n = 1$ : No, the mutex semaphore is not necessary in this case, because a nonempty buffer is equivalent to a full buffer. When the buffer contains an item, the producer is blocked. When the buffer is empty, the consumer is blocked. So at any point in time, only a single thread can access the buffer, and thus mutual exclusion is guaranteed without using the mutex.
- C.  $p > 1, c > 1, n = 1$ : No, the mutex semaphore is not necessary in this case either, by the same argument as the previous case.

## Solution to Problem 12.10

(page **1008**)

Suppose that a particular semaphore implementation uses a LIFO stack of threads for each semaphore. When a thread blocks on a semaphore in a  $P$  operation, its ID is pushed onto the stack. Similarly, the  $V$  operation pops the top thread ID from the stack and restarts that thread. Given this stack implementation, an adversarial writer in its critical section could simply wait until another writer blocks on the semaphore before releasing the semaphore. In this scenario, a waiting reader might wait forever as two writers passed control back and forth.

Notice that although it might seem more intuitive to use a FIFO queue rather than a LIFO stack, using such a stack is not incorrect and does not violate the semantics of the  $P$  and  $V$  operations.

## Solution to Problem 12.11

(page **1020**)

This problem is a simple sanity check of your understanding of speedup and parallel efficiency:

## Solution to Problem 12.12

(page **1024**)

The `ctime_ts` function is not reentrant, because each invocation shares the same `static` variable returned by the `ctime` function. However, it is thread-safe because the accesses to the shared variable are protected by *P* and *V* operations, and thus are mutually exclusive.

## Solution to Problem 12.13

(page **1026**)

If we free the block immediately after the call to `pthread_create` in line 14, then we will introduce a new race, this time between the call to `free` in the main thread and the assignment statement in line 24 of the thread routine.

# Solution to Problem 12.14

(page 1026)

- A. Another approach is to pass the integer `i` directly, rather than passing a pointer to `i`:

```
for (i = 0; i < N; i++)  
    pthread_create(&tid[i], NULL, thread, (void *)i);
```

In the thread routine, we cast the argument back to an `int` and assign it to `myid`:

```
int myid = (int) vargp;
```

- B. The advantage is that it reduces overhead by eliminating the calls to `malloc` and `free`. A significant disadvantage is that it assumes that pointers are at least as large as `ints`. While this assumption is true for all modern systems, it might not be true for legacy or future systems.

# Solution to Problem 12.15

(page 1029)

- A. The progress graph for the original program is shown in [Figure 12.48](#) on the next page.
- B. The program always deadlocks, since any feasible trajectory is eventually trapped in a deadlock state.
- C. To eliminate the deadlock potential, initialize the binary semaphore `t` to 1 instead of 0.
- D. The progress graph for the corrected program is shown in [Figure 12.49](#).



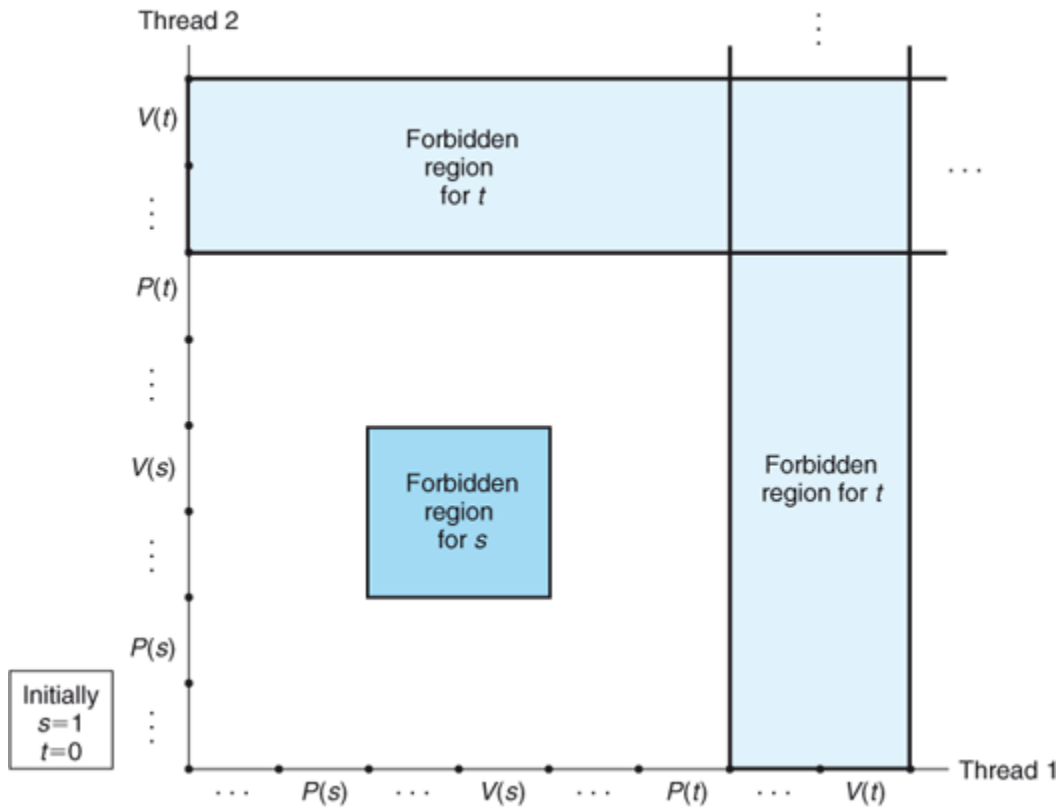


Figure 12.48 Progress graph for a program that deadlocks.

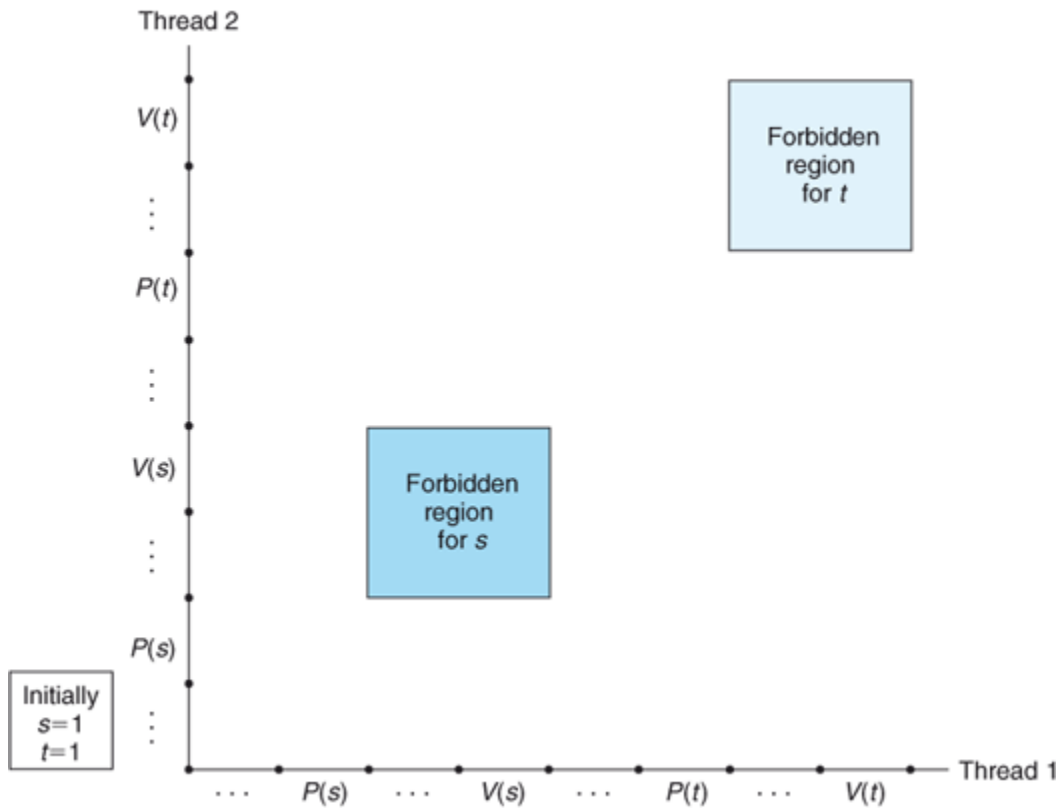


Figure 12.49 Progress graph for the corrected deadlock-free program.

# Appendix A Error Handling

Programmers should *always* check the error codes returned by system-level functions. There are many subtle ways that things can go wrong, and it only makes sense to use the status information that the kernel is able to provide us. Unfortunately, programmers are often reluctant to do error checking because it clutters their code, turning a single line of code into a multi-line conditional statement. Error checking is also confusing because different functions indicate errors in different ways.

We were faced with a similar problem when writing this text. On the one hand, we would like our code examples to be concise and simple to read. On the other hand, we do not want to give students the wrong impression that it is OK to skip error checking. To resolve these issues, we have adopted an approach based on *error-handling wrappers* that was pioneered by W. Richard Stevens in his network programming text [110].

The idea is that given some base system-level function `foo`, we define a wrapper function `Foo` with identical arguments, but with the first letter capitalized. The wrapper calls the base function and checks for errors. If it detects an error, the wrapper prints an informative message and terminates the process. Otherwise, it returns to the caller. Notice that if there are no errors, the wrapper behaves exactly like the base function. Put another way, if a program runs correctly with wrappers, it will run correctly if we render the first letter of each wrapper in lowercase and recompile.

The wrappers are packaged in a single source file (`csapp.c`) that is compiled and linked into each program. A separate header file (`csapp.h`) contains the function prototypes for the wrappers.

This appendix gives a tutorial on the different kinds of error handling in Unix systems and gives examples of the different styles of error-handling wrappers. Copies of the `csapp.h` and `csapp.c` files are available at the CS:APP Web site.

[OceanofPDF.com](http://OceanofPDF.com)

# A.1 Error Handling in Unix Systems

The systems-level function calls that we will encounter in this book use three different styles for returning errors: *Unix-style*, *Posix-style*, and *GAI-style*.

# Unix-Style Error Handling

Functions such as `fork` and `wait` that were developed in the early days of Unix (as well as some older Posix functions) overload the function return value with both error codes *and* useful results. For example, when the Unix-style `wait` function encounters an error (e.g., there is no child process to reap), it returns -1 and sets the global variable `errno` to an error code that indicates the cause of the error. If `wait` completes successfully, then it returns the useful result, which is the PID of the reaped child. Unix-style error-handling code is typically of the following form:

```
1     if ((pid = wait(NULL)) < 0) {  
2         fprintf(stderr, "wait error: %s\n", strerror(errno));  
3         exit(0);  
4     }
```

The `strerror` function returns a text description for a particular value of `errno`.

# Posix-Style Error Handling

Many of the newer Posix functions such as Pthreads use the return value only to indicate success (zero) or failure (nonzero). Any useful results are returned in function arguments that are passed by reference. We refer to this approach as *Posix-style error handling*. For example, the Posix-style `pthread_create` function indicates success or failure with its return value and returns the ID of the newly created thread (the useful result) by reference in its first argument. Posix-style error-handling code is typically of the following form:

```
|
1   if ((retcode = pthread_create(&tid, NULL, thread, NULL))
    != 0) {
2   fprintf(stderr, "pthread_create error: %s\n",
    strerror(retcode));
3   exit(0);
4   }
```

The `strerror` function returns a text description for a particular value of `retcode`.



# GAI-Style Error Handling

The `getaddrinfo` (GAI) and `getnameinfo` functions return zero on success and a nonzero value on failure. GAI error-handling code is typically of the following form:


```
1     if ((retcode = getaddrinfo(host, service, &hints,  
2     fprintf(stderr, "getaddrinfo error: %s\n",  
3     exit(0);  
4     }
```

The `gai_strerror` function returns a text description for a particular value of `retcode`.

# Summary of Error-Reporting Functions

Throughout this book, we use the following error-reporting functions to accommodate different error-handling styles.

```
|  
#include "csapp.h"  
void unix_error(char *msg);  
void posix_error(int code, char *msg);  
void gai_error(int code, char *msg);  
void app_error(char *msg);  
Returns: nothing
```

As their names suggest, the `unix_error`, `posix_error`, and `gai_error` functions report Unix-style, Posix-style, and GAI-style errors and then terminate. The `app_error` function is included as a convenience for application errors. It simply prints its input and then terminates. **Figure A.1**  shows the code for the error-reporting functions.

## A.2 Error-Handling Wrappers

Here are some examples of the different error-handling wrappers.

**Unix-style error-handling wrappers.** [Figure A.2](#) shows the wrapper for the Unix-style `wait` function. If the `wait` returns with an error, the wrapper prints an informative message and then exits. Otherwise, it returns a PID to the caller. [Figure A.3](#) shows the wrapper for the Unix-style kill function. Notice that this function, unlike `wait`, returns void on success.

**Posix-style error-handling wrappers.** [Figure A.4](#) shows the wrapper for the Posix-style `pthread_detach` function. Like most Posix-style functions, it does not overload useful results with error-return codes, so the wrapper returns void on success.

**GAI-style error-handling wrappers.** [Figure A.5](#) shows the error-handling wrapper for the GAI-style `getaddrinfo` function.

-----code/src/csapp.c

```
|  
1 void unix_error(char *msg) /* Unix-style error */  
2 {  
3     fprintf(stderr, "%s: %s\n", msg,  
strerror(errno));  
4     exit(0);  
5 }  
6  
7 void posix_error(int code, char *msg) /* Posix-style  
error */  
8 {  
9     fprintf(stderr, "%s: %s\n", msg,  
strerror(code));  
10    exit(0);  
11 }  
12  
13 void gai_error(int code, char *msg) /* Getaddrinfo-style  
error */  
14 {  
15     fprintf(stderr, "%s: %s\n", msg,  
gai_strerror(code));  
16    exit(0);  
17 }  
18  
19 void app_error(char *msg) /* Application error */  
20 {  
21     fprintf(stderr, "%s\n", msg);
```

```
22         exit(0);
23     }
```

-----code/src/csapp.c

**Figure A.1 Error-reporting functions.**

-----code/src/csapp.c

```
|
1     pid_t wait(int *status)
2     {
3         pid_t pid;
4
5         if ((pid = wait(status)) < 0)
6             unix_error("wait error");
7         return pid;
8     }
```

-----code/src/csapp.c

**Figure A.2 Wrapper for Unix-style `wait` function.**

-----code/src/csapp.c

```
|  
1 void Kill(pid_t pid, int signum)  
2 {  
3     int rc;  
4  
5     if ((rc = kill(pid, signum)) < 0)  
6         unix_error("Kill error");  
7 }
```

-----code/src/csapp.c

**Figure A.3** Wrapper for Unix-style `kill` function.

-----code/src/csapp.c

```
|  
1 void Pthread_detach(pthread_t tid) {  
2     int rc;  
3  
4     if ((rc = pthread_detach(tid)) != 0)  
5         posix_error(rc, "Pthread_detach error");  
6 }
```

-----code/src/csapp.c

**Figure A.4** Wrapper for Posix-style `pthread_detach` function.



-----code/src/csapp.c

```
|  
1 void Getaddrinfo(const char *node, const char *service,  
2                  const struct addrinfo *hints, struct  
addrinfo **res)  
3 {  
4     int rc;  
5  
6     if ((rc = getaddrinfo(node, service, hints,  
res)) != 0)  
7         gai_error(rc, "Getaddrinfo error");  
8 }
```

-----code/src/csapp.c

Figure A.5 Wrapper for GAI-style `getaddrinfo` function.

# References

- [1] Advanced Micro Devices, Inc. *Software Optimization Guide for AMD64 Processors*, 2005. Publication Number 25112.
  
- [2] Advanced Micro Devices, Inc. *AMD64 Architecture Programmer's Manual, Volume 1: Application Programming*, 2013. Publication Number 24592.
  
- [3] Advanced Micro Devices, Inc. *AMD64 Architecture Programmer's Manual, Volume 3: General-Purpose and System Instructions*, 2013. Publication Number 24594.
  
- [4] Advanced Micro Devices, Inc. *AMD64 Architecture Programmer's Manual, Volume 4: 128-Bit and 256-Bit Media Instructions*, 2013. Publication Number 26568.
  
- [5] K. Arnold, J. Gosling, and D. Holmes. *The Java Programming Language, Fourth Edition*. Prentice Hall, 2005.
  
- [6] T. Berners-Lee, R. Fielding, and H. Frystyk. Hypertext transfer protocol - HTTP/1.0. RFC 1945, 1996.
  
- [7] A. Birrell. An introduction to programming with threads. Technical Report 35, Digital Systems Research Center, 1989.
  
- [8] A. Birrell, M. Isard, C. Thacker, and T. Wobber. A design for high-performance flash disks. *SIGOPS Operating Systems Review* 41(2):88–93, 2007.

- [9] G. E. Blelloch, J. T. Fineman, P. B. Gibbons, and H. V. Simhadri. Scheduling irregular parallel computations on hierarchical caches. In *Proceedings of the 23rd Symposium on Parallelism in Algorithms and Architectures (SPAA)*, pages 355–366. ACM, June 2011.
- [10] S. Borkar. Thousand core chips: A technology perspective. In *Proceedings of the 44th Design Automation Conference*, pages 746–749. ACM, 2007.
- [11] D. Bovet and M. Cesati. *Understanding the Linux Kernel, Third Edition*. O'Reilly Media, Inc., 2005.
- [12] A. Demke Brown and T. Mowry. Taming the memory hogs: Using compiler-inserted releases to manage physical memory intelligently. In *Proceedings of the 4th Symposium on Operating Systems Design and Implementation (OSDI)*, pages 31–44. Usenix, October 2000.
- [13] R. E. Bryant. Term-level verification of a pipelined CISC microprocessor. Technical Report CMU-CS-05–195, Carnegie Mellon University, School of Computer Science, 2005.
- [14] R. E. Bryant and D. R. O'Hallaron. Introducing computer systems from a programmer's perspective. In *Proceedings of the Technical Symposium on Computer Science Education (SIGCSE)*, pages 90–94. ACM, February 2001.

- [15] D. Butenhof. *Programming with Posix Threads*. Addison-Wesley, 1997.
- [16] S. Carson and P. Reynolds. The geometry of semaphore programs. *ACM Transactions on Programming Languages and Systems* 9(1):25–53, 1987.
- [17] J. B. Carter, W. C. Hsieh, L. B. Stoller, M. R. Swanson, L. Zhang, E. L. Brunvand, A. Davis, C.-C. Kuo, R. Kuramkote, M. A. Parker, L. Schaelicke, and T. Tateyama. Impulse: Building a smarter memory controller. In *Proceedings of the 5th International Symposium on High Performance Computer Architecture (HPCA)*, pages 70–79. ACM, January 1999.
- [18] K. Chang, D. Lee, Z. Chishti, A. Alameldeen, C. Wilkerson, Y. Kim, and O. Mutlu. Improving DRAM performance by parallelizing refreshes with accesses. In *Proceedings of the 20th International Symposium on High-Performance Computer Architecture (HPCA)*. ACM, February 2014.
- [19] S. Chellappa, F. Franchetti, and M. Püschel. How to write fast numerical code: A small introduction. In *Generative and Transformational Techniques in Software Engineering II*, volume 5235 of *Lecture Notes in Computer Science*, pages 196–259. Springer-Verlag, 2008.
- [20] P. Chen, E. Lee, G. Gibson, R. Katz, and D. Patterson. RAID: High-performance, reliable secondary storage. *ACM Computing*

*Surveys* 26(2):145–185, June 1994.

- [21] S. Chen, P. Gibbons, and T. Mowry. Improving index performance through prefetching. In *Proceedings of the 2001 ACM SIGMOD International Conference on Management of Data*, pages 235–246. ACM, May 2001.
  
- [22] T. Chilimbi, M. Hill, and J. Larus. Cache-conscious structure layout. In *Proceedings of the 1999 ACM Conference on Programming Language Design and Implementation (PLDI)*, pages 1–12. ACM, May 1999.
  
- [23] E. Coffman, M. Elphick, and A. Shoshani. System deadlocks. *ACM Computing Surveys* 3(2):67–78, June 1971.
  
- [24] D. Cohen. On holy wars and a plea for peace. *IEEE Computer* 14(10):48–54, October 1981.
  
- [25] P. J. Courtois, F. Heymans, and D. L. Parnas. Concurrent control with "readers" and "writers." *Communications of the ACM* 14(10):667–668, 1971.
  
- [26] C. Cowan, P. Wagle, C. Pu, S. Beattie, and J. Walpole. Buffer overflows: Attacks and defenses for the vulnerability of the decade. In *DARPA Information Survivability Conference and Expo (DISCEX)*, volume 2, pages 119–129, March 2000.

- [27] J. H. Crawford. The i486 CPU: Executing instructions in one clock cycle. *IEEE Micro* 10(1):27–36, February 1990.
- [28] V. Cuppu, B. Jacob, B. Davis, and T. Mudge. A performance comparison of contemporary DRAM architectures. In *Proceedings of the 26th International Symposium on Computer Architecture (ISCA)*, pages 222–233, ACM, 1999.
- [29] B. Davis, B. Jacob, and T. Mudge. The new DRAM interfaces: SDRAM, RDRAM, and variants. In *Proceedings of the 3rd International Symposium on High Performance Computing (ISHPC)*, volume 1940 of *Lecture Notes in Computer Science*, pages 26–31. Springer-Verlag, October 2000.
- [30] E. Demaine. Cache-oblivious algorithms and data structures. In *Lecture Notes from the EEF Summer School on Massive Data Sets*. BRICS, University of Aarhus, Denmark, 2002.
- [31] E. W. Dijkstra. Cooperating sequential processes. Technical Report EWD-123, Technological University, Eindhoven, the Netherlands, 1965.
- [32] C. Ding and K. Kennedy. Improving cache performance of dynamic applications through data and computation reorganizations at run time. In *Proceedings of the 1999 ACM Conference on Programming Language Design and Implementation (PLDI)*, pages 229–241. ACM, May 1999.

- [33] M. Dowson. The Ariane 5 software failure. *SIGSOFT Software Engineering Notes* 22(2):84, 1997.
- [34] U. Drepper. User-level IPv6 programming introduction. Available at <http://www.akkadia.org/drepper/userapi-ipv6.html>, 2008.
- [35] M. W. Eichen and J. A. Rochlis. With micro- scope and tweezers: An analysis of the Internet virus of November, 1988. In *Proceedings of the IEEE Symposium on Research in Security and Privacy*, pages 326–343. IEEE, 1989.
- [36] *ELF-64 Object File Format, Version 1.5 Draft 2*, 1998. Available at <http://www.uclibc.org/docs/elf-64-gen.pdf>.
- [37] R. Fielding, J. Gettys, J. Mogul, H. Frystyk, L. Masinter, P. Leach, and T. Berners-Lee. Hypertext transfer protocol - HTTP/1.1. RFC 2616, 1999.
- [38] M. Frigo, C. E. Leiserson, H. Prokop, and S. Ramachandran. Cache-oblivious algorithms. In *Proceedings of the 40th IEEE Symposium on Foundations of Computer Science (FOCS)*, pages 285–297. IEEE, August 1999.
- [39] M. Frigo and V. Strumpen. The cache complexity of multithreaded cache oblivious algorithms. In *Proceedings of the 18th Symposium on Parallelism in Algorithms and Architectures (SPAA)*, pages 271–280. ACM, 2006.



- [40] G. Gibson, D. Nagle, K. Amiri, J. Butler, F. Chang, H. Gobioff, C. Hardin, E. Riedel, D. Rochberg, and J. Zelenka. A cost-effective, high-bandwidth storage architecture. In *Proceedings of the 8th International Conference on Architectural Support for Programming Languages and Operating Systems (ASPLOS)*, pages 92–103. ACM, October 1998.
- [41] G. Gibson and R. Van Meter. Network attached storage architecture. *Communications of the ACM* 43(11):37–45, November 2000.
- [42] Google. IPv6 Adoption. Available at <http://www.google.com/intl/en/ipv6/statistics.html>.
- [43] J. Gustafson. Reevaluating Amdahl's law. *Communications of the ACM* 31(5):532–533, August 1988.
- [44] L. Gwennap. New algorithm improves branch prediction. *Microprocessor Report* 9(4), March 1995.
- [45] S. P. Harbison and G. L. Steele, Jr. *C, A Reference Manual, Fifth Edition*. Prentice Hall, 2002.
- [46] J. L. Hennessy and D. A. Patterson. *Computer Architecture: A Quantitative Approach, Fifth Edition*. Morgan Kaufmann, 2011.
- [47] M. Herlihy and N. Shavit. *The Art of Multi-processor Programming*. Morgan Kaufmann, 2008.

- [48] C. A. R. Hoare. Monitors: An operating system structuring concept. *Communications of the ACM* 17(10):549–557, October 1974.
- [49] Intel Corporation. *Intel 64 and IA-32 Architectures Optimization Reference Manual*. Available at <http://www.intel.com/content/www/us/en/processors/architectures-software-developer-manuals.html>.
- [50] Intel Corporation. *Intel 64 and IA-32 Architectures Software Developer's Manual, Volume 1: Basic Architecture*. Available at <http://www.intel.com/content/www/us/en/processors/architectures-software-developer-manuals.html>.
- [51] Intel Corporation. *Intel 64 and IA-32 Architectures Software Developer's Manual, Volume 2: Instruction Set Reference*. Available at <http://www.intel.com/content/www/us/en/processors/architectures-software-developer-manuals.html>.
- [52] Intel Corporation. *Intel 64 and IA-32 Architectures Software Developer's Manual, Volume 3a: System Programming Guide, Part 1*. Available at <http://www.intel.com/content/www/us/en/processors/architectures-software-developer-manuals.html>.
- [53] Intel Corporation. *Intel Solid-State Drive 730 Series: Product Specification*. Available at <http://www.intel.com/content/www/us/en/solid-state-drives/ssd-730-series-spec.html>.

- [54] Intel Corporation. *Tool Interface Standards Portable Formats Specification, Version 1.1*, 1993. Order number 241597.
- [55] F. Jones, B. Prince, R. Norwood, J. Hartigan, W. Vogley, C. Hart, and D. Bondurant. Memory—a new era of fast dynamic RAMs (for video applications). *IEEE Spectrum*, pages 43–45, October 1992.
- [56] R. Jones and R. Lins. *Garbage Collection: Algorithms for Automatic Dynamic Memory Management*. Wiley, 1996.
- [57] M. Kaashoek, D. Engler, G. Ganger, H. Briceo, R. Hunt, D. Maziers, T. Pinckney, R. Grimm, J. Jannotti, and K. MacKenzie. Application performance and flexibility on Exokernel systems. In *Proceedings of the 16th ACM Symposium on Operating System Principles (SOSP)*, pages 52–65. ACM, October 1997.
- [58] R. Katz and G. Borriello. *Contemporary Logic Design, Second Edition*. Prentice Hall, 2005.
- [59] B. W. Kernighan and R. Pike. *The Practice of Programming*. Addison-Wesley, 1999.
- [60] B. Kernighan and D. Ritchie. *The C Programming Language, First Edition*. Prentice Hall, 1978.
- [61] B. Kernighan and D. Ritchie. *The C Programming Language, Second Edition*. Prentice Hall, 1988.

- [62] Michael Kerrisk. *The Linux Programming Interface*. No Starch Press, 2010.
- [63] T. Kilburn, B. Edwards, M. Lanigan, and F. Sumner. One-level storage system. *IRE Transactions on Electronic Computers* EC-11:223–235, April 1962.
- [64] D. Knuth. *The Art of Computer Programming, Volume 1: Fundamental Algorithms, Third Edition*. Addison-Wesley, 1997.
- [65] J. Kurose and K. Ross. *Computer Networking: A Top-Down Approach, Sixth Edition*. Addison-Wesley, 2012.
- [66] M. Lam, E. Rothberg, and M. Wolf. The cache performance and optimizations of blocked algorithms. In *Proceedings of the 4th International Conference on Architectural Support for Programming Languages and Operating Systems (ASPLOS)*, pages 63–74. ACM, April 1991.
- [67] D. Lea. A memory allocator. Available at <http://gee.cs.oswego.edu/dl/html/malloc.html>, 1996.
- [68] C. E. Leiserson and J. B. Saxe. Retiming synchronous circuitry. *Algorithmica* 6(1–6), June 1991.
- [69] J. R. Levine. *Linkers and Loaders*. Morgan Kaufmann, 1999.

- [70] David Levinthal. *Performance Analysis Guide for Intel Core i7 Processor and Intel Xeon 5500 Processors*. Available at [https://software.intel.com/sites/products/collateral/hpc/vtune/performance\\_analysis\\_guide.pdf](https://software.intel.com/sites/products/collateral/hpc/vtune/performance_analysis_guide.pdf).
- [71] C. Lin and L. Snyder. *Principles of Parallel Programming*. Addison Wesley, 2008.
- [72] Y. Lin and D. Padua. Compiler analysis of irregular memory accesses. In *Proceedings of the 2000 ACM Conference on Programming Language Design and Implementation (PLDI)*, pages 157–168. ACM, June 2000.
- [73] J. L. Lions. Ariane 5 Flight 501 failure. Technical Report, European Space Agency, July 1996.
- [74] S. Macguire. *Writing Solid Code*. Microsoft Press, 1993.
- [75] S. A. Mahlke, W. Y. Chen, J. C. Gyllenhal, and W. W. Hwu. Compiler code transformations for superscalar-based high-performance systems. In *Proceedings of the 1992 ACM/IEEE Conference on Supercomputing*, pages 808–817. ACM, 1992.
- [76] E. Marshall. Fatal error: How Patriot overlooked a Scud. *Science*, page 1347, March 13, 1992.
- [77] M. Matz, J. Hubička, A. Jaeger, and M. Mitchell. System V application binary interface AMD64 architecture processor

supplement. Technical Report, x86-64.org, 2013. Available at [http://www.x86-64.org/documentation\\_folder/abi-0.99.pdf](http://www.x86-64.org/documentation_folder/abi-0.99.pdf).

- [78] J. Morris, M. Satyanarayanan, M. Conner, J. Howard, D. Rosenthal, and F. Smith. Andrew: A distributed personal computing environment. *Communications of the ACM*, pages 184–201, March 1986.
  
- [79] T. Mowry, M. Lam, and A. Gupta. Design and evaluation of a compiler algorithm for prefetching. In *Proceedings of the 5th International Conference on Architectural Support for Programming Languages and Operating Systems (ASPLOS)*, pages 62–73. ACM, October 1992.
  
- [80] S. S. Muchnick. *Advanced Compiler Design and Implementation*. Morgan Kaufmann, 1997.
  
- [81] S. Nath and P. Gibbons. Online maintenance of very large random samples on flash storage. In *Proceedings of VLDB*, pages 970–983. VLDB Endowment, August 2008.
  
- [82] M. Overton. *Numerical Computing with IEEE Floating Point Arithmetic*. SIAM, 2001.
  
- [83] D. Patterson, G. Gibson, and R. Katz. A case for redundant arrays of inexpensive disks (RAID). In *Proceedings of the 1998 ACM SIGMOD International Conference on Management of Data*, pages 109–116. ACM, June 1988.

- [84] L. Peterson and B. Davie. *Computer Networks: A Systems Approach, Fifth Edition*. Morgan Kaufmann, 2011.
- [85] J. Pincus and B. Baker. Beyond stack smashing: Recent advances in exploiting buffer overruns. *IEEE Security and Privacy* 2(4):20–27, 2004.
- [86] S. Przybylski. *Cache and Memory Hierarchy Design: A Performance-Directed Approach*. Morgan Kaufmann, 1990.
- [87] W. Pugh. The Omega test: A fast and practical integer programming algorithm for dependence analysis. *Communications of the ACM* 35(8):102–114, August 1992.
- [88] W. Pugh. Fixing the Java memory model. In *Proceedings of the ACM Conference on Java Grande*, pages 89–98. ACM, June 1999.
- [89] J. Rabaey, A. Chandrakasan, and B. Nikolic. *Digital Integrated Circuits: A Design Perspective, Second Edition*. Prentice Hall, 2003.
- [90] J. Reinders. *Intel Threading Building Blocks*. O'Reilly, 2007.
- [91] D. Ritchie. The evolution of the Unix time-sharing system. *AT&T Bell Laboratories Technical Journal* 63(6 Part 2):1577–1593, October 1984.

- [92] D. Ritchie. The development of the C language. In *Proceedings of the 2nd ACM SIGPLAN Conference on History of Programming Languages*, pages 201–208. ACM, April 1993.
- [93] D. Ritchie and K. Thompson. The Unix time-sharing system. *Communications of the ACM* 17(7):365–367, July 1974.
- [94] M. Satyanarayanan, J. Kistler, P. Kumar, M. Okasaki, E. Siegel, and D. Steere. Coda: A highly available file system for a distributed workstation environment. *IEEE Transactions on Computers* 39(4):447–459, April 1990.
- [95] J. Schindler and G. Ganger. Automated disk drive characterization. Technical Report CMU- CS-99–176, School of Computer Science, Carnegie Mellon University, 1999.
- [96] F. B. Schneider and K. P. Birman. The monoculture risk put into context. *IEEE Security and Privacy* 7(1):14–17, January 2009.
- [97] R. C. Seacord. *Secure Coding in C and C++, Second Edition*. Addison-Wesley, 2013.
- [98] R. Sedgewick and K. Wayne. *Algorithms, Fourth Edition*. Addison-Wesley, 2011.
- [99] H. Shacham, M. Page, B. Pfaff, E.-J. Goh, N. Modadugu, and D. Boneh. On the effectiveness of address-space randomization. In



*Proceedings of the 11th ACM Conference on Computer and Communications Security (CCS)*, pages 298–307. ACM, 2004.

- [100] J. P. Shen and M. Lipasti. *Modern Processor Design: Fundamentals of Superscalar Processors*. McGraw Hill, 2005.
- [101] B. Shriver and B. Smith. *The Anatomy of a High-Performance Microprocessor: A Systems Perspective*. IEEE Computer Society, 1998.
- [102] A. Silberschatz, P. Galvin, and G. Gagne. *Operating Systems Concepts, Ninth Edition*. Wiley, 2014.
- [103] R. Skeel. Roundoff error and the Patriot missile. *SIAM News* 25(4):11, July 1992.
- [104] A. Smith. Cache memories. *ACM Computing Surveys* 14(3), September 1982.
- [105] E. H. Spafford. The Internet worm program: An analysis. Technical Report CSD-TR-823, Department of Computer Science, Purdue University, 1988.
- [106] W. Stallings. *Operating Systems: Internals and Design Principles, Eighth Edition*. Prentice Hall, 2014.
- [107] W. R. Stevens. *TCP/IP Illustrated, Volume 3: TCP for Transactions, HTTP, NNTP and the Unix Domain Protocols*.

Addison-Wesley, 1996.

- [108] W. R. Stevens. *Unix Network Programming: Interprocess Communications, Second Edition*, volume 2. Prentice Hall, 1998.
- [109] W. R. Stevens and K. R. Fall. *TCP/IP Illustrated, Volume 1: The Protocols, Second Edition*. Addison-Wesley, 2011.
- [110] W. R. Stevens, B. Fenner, and A. M. Rudoff. *Unix Network Programming: The Sockets Networking API, Third Edition*, volume 1. Prentice Hall, 2003.
- [111] W. R. Stevens and S. A. Rago. *Advanced Programming in the Unix Environment, Third Edition*. Addison-Wesley, 2013.
- [112] T. Stricker and T. Gross. Global address space, non-uniform bandwidth: A memory system performance characterization of parallel systems. In *Proceedings of the 3rd International Symposium on High Performance Computer Architecture (HPCA)*, pages 168–179. IEEE, February 1997.
- [113] A. S. Tanenbaum and H. Bos. *Modern Operating Systems, Fourth Edition*. Prentice Hall, 2015.
- [114] A. S. Tanenbaum and D. Wetherall. *Computer Networks, Fifth Edition*. Prentice Hall, 2010.

- [115] K. P. Wadleigh and I. L. Crawford. *Software Optimization for High-Performance Computing: Creating Faster Applications*. Prentice Hall, 2000.
- [116] J. F. Wakerly. *Digital Design Principles and Practices, Fourth Edition*. Prentice Hall, 2005.
- [117] M. V. Wilkes. Slave memories and dynamic storage allocation. *IEEE Transactions on Electronic Computers*, EC-14(2), April 1965.
- [118] P. Wilson, M. Johnstone, M. Neely, and D. Boles. Dynamic storage allocation: A survey and critical review. In *International Workshop on Memory Management*, volume 986 of *Lecture Notes in Computer Science*, pages 1–116. Springer-Verlag, 1995.
- [119] M. Wolf and M. Lam. A data locality algorithm. In *Proceedings of the 1991 ACM Conference on Programming Language Design and Implementation (PLDI)*, pages 30–44, June 1991.
- [120] G. R. Wright and W. R. Stevens. *TCP/IP Illustrated, Volume 2: The Implementation*. Addison-Wesley, 1995.
- [121] J. Wylie, M. Bigrigg, J. Strunk, G. Ganger, H. Kiliccote, and P. Khosla. Survivable information storage systems. *IEEE Computer* 33:61–68, August 2000.

[122] T.-Y. Yeh and Y. N. Patt. Alternative implementation of two-level adaptive branch prediction. In *Proceedings of the 19th Annual International Symposium on Computer Architecture (ISCA)*, pages 451–461. ACM, 1998.

[OceanofPDF.com](http://OceanofPDF.com)

# Index

Page numbers of defining references are *italicized*. Entries that belong to a hardware or software system are followed by a tag in brackets that identifies the system, along with a brief description to jog your memory. Here is the list of tags and their meanings.

- ! [HCL] NOT operation, **373**
- \$ for immediate operands, **181**
- & [C] address of operation
  - local variables, **248**
  - logic gates, **373**
  - pointers, **48, 188, 257, 277**
- \* [C] dereference pointer operation, **188**
- -> [C] dereference and select field operation, **266**
- . (periods) in dotted-decimal notation, **926**
- || [HCL] OR operation, **373**
- < operator for left hoinkies, **909**
- << "put to" operator (C++), **890**
- > operator for right hoinkies, **909**
- >> "get from" operator (C++), **890**
- +<sup>t</sup><sub>w</sub> (two's-complement addition), **60, 90**
- \*<sup>t</sup><sub>w</sub> (two's-complement multiplication), **60, 97**
- -<sup>t</sup><sub>w</sub> (two's-complement negation), **60, 95**
- +<sup>u</sup><sub>w</sub> (unsigned addition), **60, 85, 89**

- $*^u_w$  (unsigned multiplication), **60**, **96**
- $-^u_w$  (unsigned negation), **60**, **89**
- 8086 microprocessor, **167**
- 8087 floating-point coprocessor, **109**, **137**, **167**
- 80286 microprocessor, **167**

[OceanofPDF.com](http://OceanofPDF.com)

- `.a` archive files, [686](#)
- `a.out` object file, [673](#)
- Abel, Niels Henrik, [89](#)
- abelian group, [89](#)
- ABI (application binary interface), [310](#)
- abort exception class, [726](#)
- aborts, [728](#)
- absolute addressing relocation type, [691](#), [693–694](#)
- absolute pathnames, [893](#)
- absolute speedup of parallel programs, [1019](#)
- abstract operation model for Core i7, [525–531](#)
- abstractions, [27](#)
- `accept` [Unix] wait for client connection request, [933](#), [936](#), [936–937](#)
- access
  - disks, [597–600](#)
  - IA32 registers, [179–180](#)
  - main memory, [587–589](#)
  - x86–64 registers
  - data movement, [182–189](#)
  - operand specifiers, [180–182](#)
- access permission bits, [894](#)
- access time for disks, [593](#), [593–595](#)
- accumulator variable expansion, [570](#)
- accumulators, multiple, [536–541](#)
- Acorn RISC machine (ARM)
  - ISAs, [352](#)
  - processor architecture, [363](#)

- actions, signal, **762**
- active sockets, **935**
- actuator arms, **592**
- acyclic networks, **374**
- adapters, **9, 597**
- ADD [instruction class] add, **192**
- `add_client` function, **981, 983**
- add every signal to signal set instruction, **765**
- add instruction, **192**
- ADD operation in execute stage, **408**
- add signal to signal set instruction, **765**
- `adder` [CS:APP] CGI adder, **955**
- addition
  - floating point, **122–124, 302**
  - two's complement, **90, 90–95**
  - unsigned, **84–90, 85**
  - Y86–64, **356**
- additive inverse, **52**
- `addq` [Y86–64] add, **356, 402**
- address exceptions, status code for, **404**
- address of operator (&) [C]
  - local variables, **248**
  - logic gates, **373**
  - pointers, **48, 188, 257, 277**
- address order of free lists, **863**
- address partitioning in caches, **615, 615–616**
- address-space layout randomization (ASLR), **285, 285–286**
- address spaces, **804**



- child processes, [741](#)
- linear, [804](#)
- private, [734](#)
- virtual, [804–805](#)
- address translation, [804](#)
  - caches and VM integration, [817](#)
  - Core i7, [826–828](#)
  - end-to-end, [821–825](#)
  - multi-level page tables, [819–821](#)
  - optimizing, [830](#)
  - overview, [813–816](#)
  - TLBs for, [817–819](#)
- addresses and addressing
  - byte ordering, [42–49](#)
  - effective, [690](#)
  - flat, [167](#)
  - internet, [922](#)
  - invalid address status code, [364](#)
  - I/O devices, [598](#)
  - IP, [924](#), [925–927](#)
  - machine-level programming, [170–171](#)
  - operands, [181](#)
  - out of bounds. See [buffer overflow](#)
  - physical vs. virtual, [803–804](#)
  - pointers, [257](#), [277](#)
  - procedure return, [240](#)
  - segmented, [287–288](#)
  - sockets, [930](#), [933–934](#)

- structures, [265–267](#)
- symbol relocation, [690–691](#)
- virtual, [804](#)
- virtual memory, [34](#)
- Y86–64, [356](#), [359](#)
- addressing modes, [181](#)
- adjacency matrices, [660](#)
- `ADR` [Y86–64] status code indicating invalid address, [364](#)
- Advanced Micro Devices (AMD), [165](#), [168](#)
  - Intel compatibility, [168](#)
  - x86–64. See [x86–64 microprocessors](#)
- Advanced Research Projects Administration (ARPA), [931](#)
- advanced vector extensions (AVX) instructions, [294](#), [546–547](#)
- AFS (Andrew File System), [610](#)
- aggregate data types, [171](#)
- aggregate payloads, [845](#)
- `%al` [x86–64] low order 8 of register `%rax`, [180](#)
- `alarm` [Unix] schedule alarm to self, [762](#), [763](#)
- algebra, Boolean, [50–53](#), [52](#)
- aliasing memory, [499](#), [500](#)
- `.align` directive, [366](#)
- alignment
  - data, [273](#), [273–276](#)
  - memory blocks, [844](#)
- `alloca` [Unix] stack storage allocation function, [285](#), [290](#), [324](#)
- allocate and initialize bounded buffer function, [1007](#)
- allocate heap block function, [860](#), [861](#)
- allocate heap storage function, [840](#)

- allocated bit, **848**
- allocated blocks
  - vs. free, **839**
  - placement, **849**
- allocation
  - blocks, **860**
  - dynamic memory. See **dynamic memory allocation**
  - pages, **810**
- allocators
  - block allocation, **860**
  - block freeing and coalescing, **860**
  - free list creation, **857–859**
  - free list manipulation, **856–857**
  - general design, **854–856**
  - practice problems, **861–862**
  - requirements and goals, **844–845**
  - styles, **839–840**
- Alpha (Compaq Computer Corp.)
  - RISC processors, **363**
  - alternate representations of signed integers, **68**
  - `ALUADD` [Y86–64] function code for
  - `addq` instruction, **404**
- ALUs (arithmetic/logic units), **10**
  - combinational circuits, **380**
  - in execute stage, **385**
  - sequential Y86–64 implementation, **408–409**
- always taken branch prediction strategy, **428**
- AMD (Advanced Micro Devices), **165, 168**

- Intel compatibility, **168**
  - microprocessor data alignment, **276**
  - x86–64. See **x86–64 microprocessors**
- Amdahl, Gene, **22**
- Amdahl's law, **22, 22–24, 562, 568**
- American National Standards Institute (ANSI), **4, 35**
- ampersands (&) address operator, **248**
  - local addresses, **248**
  - logic gates, **373**
  - pointers, **48, 188, 257, 277**
- AND [instruction class] and, **192**
- and instruction, **192**
- AND operations
  - Boolean, **51–52**
  - execute stage, **408**
  - HCL expressions, **374–375**
  - logic gates, **373**
  - logical, **56–57**
- AND packed double precision instruction, **305**
- AND packed single precision instruction, **305**
- `andq` [Y86–64] and, **356**
- Andreesen, Marc, **949**
- Andrew File System (AFS), **610**
- anonymous files, **833**
- ANSI (American National Standards Institute), **4, 35**
- `AOK` [Y86–64] status code for normal operation, **363**
- `app_error` [CS:APP] reports application errors, **1043**
- application binary interface (ABI), **310**

- applications, loading and linking shared libraries from, [701–703](#)
- AR Linux archiver, [686](#), [713](#)
- arbitrary size arithmetic, [85](#)
- Archimedes, [140](#)
- architecture
  - floating-point, [293](#), [293–296](#)
  - Y86. See Y86–64 instruction set architecture
- archives, [686](#)
- areal density of disks, [591](#)
- areas
  - shared, [834](#)
  - swap, [833](#)
  - virtual memory, [830](#)
- arguments
  - `execve` function, [750](#)
  - Web servers, [953–954](#)
- arithmetic, [33](#), [191](#)
  - discussion, [196–197](#)
  - floating-point code, [302–304](#)
  - integer. See [integer arithmetic](#)
  - latency and issue time, [523](#)
  - load effective address, [191–193](#)
  - pointers, [257–258](#), [873](#)
  - saturating, [134](#)
  - shift operations, [58](#), [104–106](#), [192](#), [194–196](#)
  - special, [197–200](#)
  - unary and binary, [194–196](#)
- arithmetic/logic units (ALUs), [10](#)

- combinational circuits, **380**
- in execute stage, **385**
- sequential Y86–64 implementation, **408–409**
- ARM (Acorn RISC machine), **43**
  - ISAs, **352**
  - processor architecture, **363**
- ARM A7 microprocessor, **353**
- arms, actuator, **592**
- ARPA (Advanced Research Projects Administration), **931**
- ARPANET, **931**
- arrays, **255**
  - basic principles, **255–257**
  - declarations, **255–256, 263**
  - DRAM, **582**
  - fixed-size, **260–262**
  - machine-code representation, **171**
  - nested, **258–260**
  - pointer arithmetic, **257–258**
  - pointer relationships, **48, 277**
  - stride, **606**
  - variable-size, **262–265**
- ASCII standard, **3**
  - character codes, **49**
  - limitations, **50**
- `asctime` function, **1024**
- ASLR (address-space layout randomization), **285, 285–286**
- `asm` directive, **178**
- `assembler` directives, **366**

- `assemblers`, [5](#), [5](#), [164](#), [170](#)
- `assembly` code, [5](#), [164](#)
  - with C programs, [289–290](#)
  - formatting, [175–177](#)
  - Y86–64, [359](#)
- assembly phase, [5](#)
- associate socket address with descriptor function, [935](#), [935](#)
- associative caches, [624–626](#)
- associative memory, [625](#)
- associativity
  - caches, [633](#)
  - floating-point addition, [123–124](#)
- asterisks (\*) dereference pointer operation, [188](#), [257](#), [277](#)
- asymmetric ranges in two's-complement representation, [66](#), [77](#)
- `async-signal-safe` function, [766](#)
- `async-signal` safety, [766](#)
- asynchronous interrupts, [726](#)
- atomic reads and writes, [770](#)
- ATT assembly code format, [177](#), [294](#), [311](#)
  - argument listing, [306](#)
  - condition codes, [201–202](#)
  - `cqo` instruction, [199](#)
  - vs. Intel, [177](#)
  - operands, [181](#), [192](#)
  - Y86–64, [356](#)
- automatic variables, [994](#)
- AVX (advanced vector extensions) instructions, [276](#), [294](#), [546–547](#)

- `%ax` [x86–64] low order 16 bits of register `%rax`, **180**

[OceanofPDF.com](http://OceanofPDF.com)



- *B2T* (binary to two's-complement conversion), [60](#), [64](#), [72](#), [97](#)
- *B2U* (binary to unsigned conversion), [60](#), [62](#), [72](#), [82](#), [97](#)
- background processes, [753](#), [753–756](#)
- backlogs for listening sockets, [935](#)
- backups for disks, [611](#)
- backward compatibility, [35](#)
- backward taken, forward not taken (BTFNT) branch prediction strategy, [428](#)
- bad pointers and virtual memory, [870–871](#)
- `badcnt.c` [CS:APP] improperly synchronized program, [995–999](#), [996](#)
- bandwidth, read, [639](#)
- Barracuda 7400 drives, [600](#)
- base pointers, [290](#)
- base registers, [181](#)
- `bash` [Unix] Unix shell program, [753](#)
- basic blocks, [569](#)
- Bell Laboratories, [35](#)
- Berkeley sockets, [932](#)
- Berners-Lee, Tim, [949](#)
- best-fit block placement policy, [849](#), [849](#)
- bi-endian ordering convention, [43](#)
- biased number encoding, [113](#), [113–117](#)
- biasing in division, [106](#)
- big-endian ordering convention, [42](#), [42–44](#)
- bigrams statistics, [565](#)
- bijections, [64](#), [64](#)
- `/bin/kill` program, [760](#)

- binary files, [3](#), [891](#)
- binary notation, [32](#)
- binary points, [110](#), [110–111](#)
- binary representations
  - conversions
  - with hexadecimal, [36–37](#)
  - signed and unsigned, [70–76](#)
  - to two's complement, [64](#), [72–73](#), [97](#)
  - to unsigned, [62–63](#)
  - fractional, [109–112](#)
  - machine language, [194](#)
- binary semaphores, [1003](#)
- binary tree structure, [270–271](#)
- `bind` [Unix] associate socket address with descriptor, [933](#), [935](#), [935](#)
- binding, lazy, [706](#)
- binutils package, [713](#)
- bistable memory cells, [581](#)
- bit-level operations, [54–56](#)
- bit representation expansion, [76–80](#)
- bit vectors, [51](#), [51–52](#)
- bits, [3](#)
  - overview, [32](#)
  - union access to, [271–272](#)
- bitwise operations, [305–306](#)
- `%b1` [x86–64] low order 8 of register `%rbx`, [180](#)
- block and unblock signals instruction, [765](#)
- block devices, [892](#)

- block offset bits, **616**
- block pointers, **856**
- block size
  - caches, **633**
  - minimum, **848**
- blocked bit vectors, **759**
- blocked signals, **758, 759, 764–765**
- blocking
  - signals, **764–765**
  - for temporal locality, **647**
- blocks
  - aligning, **844**
  - allocated, **839, 849**
  - vs. cache lines, **634**
  - caches, **611, 611–612, 615, 633**
  - coalescing, **850–851, 860**
  - epilogue, **855**
  - free lists, **847–849**
  - freeing, **860**
  - heap, **839**
  - logical disk, **595, 595–596, 601**
  - prologue, **855**
  - referencing data in, **874–875**
  - splitting, **849–850**
- bodies, response, **952**
- `bool` [HCL] bit-level signal, **374**
- Boole, George, **50**
- Boolean algebra and functions, **50**

- HCL, [374–375](#)
- logic gates, [373](#)
- properties, [52](#)
- working with, [50–53](#)
- Boolean rings, [52](#)
- bottlenecks, [562](#)
  - profilers, [565–568](#)
  - program profiling, [562–564](#)
- bottom of stack, [190](#)
- boundary tags, [851](#), [851–854](#), [859](#)
- bounded buffers, [1004](#), [1005–1006](#)
- bounds
  - latency, [518](#), [524](#)
  - throughput, [518](#), [524](#)
- `%bp` [x86–64] low order 16 bits of register `%rbp`, [180](#)
- `%bp1` [x86–64] low order 8 of register `%rbp`, [180](#)
- branch prediction, [519](#), [519](#)
  - misprediction handling, [443–444](#)
  - performance, [549–553](#)
  - Y86–64 pipelining, [428](#)
- branch prediction logic, [215](#)
- branches, conditional, [172](#), [209](#)
  - assembly form, [211](#)
  - condition codes, [201–202](#)
  - condition control, [209–213](#)
  - moves, [214–220](#), [550–553](#)
  - `switch`, [232–238](#)
- `break` command

- in GDB, [280](#)
  - with `switch`, [233](#)
- break `multstore` command in GDB, [280](#)
- breakpoints, [279–280](#)
- bridged Ethernet, [920](#), [921](#)
- bridges
  - Ethernet, [920](#)
  - I/O, [587](#)
- browsers, [948](#), [949](#)
- `.bss` section, [674](#)
- BTFNT (backward taken, forward not taken) branch prediction strategy, [428](#)
- bubbles, pipeline, [434](#), [434–435](#), [459–460](#)
- buddies, [865](#)
- buddy systems, [865](#), [865](#)
- buffer overflow, [279](#)
  - execution code regions limits for, [289–290](#)
  - memory-related bugs, [871](#)
  - overview, [279–284](#)
  - stack corruption detection for, [286–289](#)
  - stack randomization for, [284–286](#)
  - vulnerabilities, [7](#)
- buffered I/O functions, [898–902](#)
- buffers
  - bounded, [1004](#), [1005–1006](#)
  - read, [898](#), [900–901](#)
  - store, [557–558](#)
  - streams, [911](#)

- bus transactions, **587**
- buses, **8**, **587**
  - designs, **588**, **598**
  - I/O, **596**
  - memory, **587**
- bypassing for data hazards, **436–439**
- byte data connections in hardware diagrams, **398**
- byte order, **42–49**
  - disassembled code, **209**
  - network, **925**
  - unions, **272**
- bytes, **3**, **34**
  - copying, **133**
  - range, **36**
  - register operations, **181**
  - Y86 encoding, **359–360**
- `%bx` [x86–64] low order 16 bits of register `%rbx`, **180**

- C language
  - bit-level operations, [54–56](#)
  - floating-point representation, [124–126](#)
  - history, [35](#)
  - logical operations, [56–57](#)
  - origins, [4](#)
  - shift operations, [57–59](#)
  - static libraries, [684–688](#)
- C++ language, [677](#)
  - linker symbols, [680](#)
  - objects, [266–267](#)
  - software exceptions, [723–724](#), [786](#)
- `.c` source files, [671](#)
- C standard library, [4–5](#), [6](#)
- C11 standard, [35](#)
- C90 standard, [35](#)
- C99 standard, [35](#)
  - fixed data sizes, [41](#)
  - integral data types, [67](#)
- cache block offset (CO), [823](#)
- cache blocks, [615](#)
- cache-friendly code, [633–639](#), [634](#)
- cache lines
  - cache sets, [615](#)
  - vs. sets and blocks, [634](#)
- cache-oblivious algorithms, [649](#)
- cache set index (CI), [823](#)
- cache tags (CT), [823](#)

- cached pages, [806](#)
- caches and cache memory, [610](#), [615](#)
  - address translation, [823](#)
  - anatomy, [631](#)
  - associativity, [633](#)
  - cache-friendly code, [633–639](#), [634](#)
  - data, [520](#), [631](#), [631](#)
  - direct-mapped. See [direct-mapped caches](#)
  - DRAM, [806](#)
  - fully associative, [627–628](#)
  - hits, [612](#)
  - importance, [11–14](#)
  - instruction, [518](#), [631](#), [631](#)
  - locality in, [605](#), [643–647](#), [810](#)
  - managing, [613](#)
  - memory mountains, [639–643](#)
  - misses, [470](#), [612](#), [612–613](#)
  - organization, [615–617](#)
  - overview, [610–612](#)
  - page allocation, [810](#)
  - page faults, [808](#), [808–809](#)
  - page hits, [808](#)
  - page tables, [806–808](#), [807](#)
  - performance, [533](#), [631–633](#), [639–647](#)
  - practice problems, [628–630](#)
  - proxy, [952](#)
  - purpose, [580](#)
  - set associative, [624](#), [624–626](#)



- size, [632](#)
- SRAM, [806](#)
- symbols, [617](#)
- virtual memory with, [805–811](#), [817](#)
- write issues, [630–631](#)
- write strategies, [633](#)
- Y86–64 pipelining, [469–470](#)
- `call` [x86–64] procedure call, [241–242](#), [357](#)
- `call` [Y86–64] instruction, [404](#), [428](#)
- callee procedures, [251](#)
- callee-save registers, [251](#), [251–252](#)
- caller procedures, [251](#)
- caller-save registers, [251](#), [251–252](#)
- calling environments, [783](#)
- `calloc` function [C Stdlib] memory allocation
  - declaration, [134](#)
  - dynamic memory allocation, [841](#)
  - security vulnerability, [100–101](#)
- `callq` [x86–64] procedure call, [241](#)
- calls, [17](#), [727–728](#)
  - error handling, [737–738](#)
  - Linux/x86–64 systems, [730–731](#)
  - in performance, [512–513](#)
- canary values, [286–287](#)
- canceling mispredicted branch handling, [444](#)
- capacity
  - caches, [615](#)
  - disks, [591](#), [591–592](#)

- functional units, **523**
- capacity misses, **613**
- cards, graphics, **597**
- carriage return (CR) characters, **892**
- carry flag condition code, **201, 306**
- CAS (column access strobe) requests, **583**
- case expressions in HCL, **378, 378**
- casting, **44**
  - explicit, **75**
  - floating-point values, **125**
  - pointers, **278, 854**
  - signed values, **70–71**
- catching signals, **758, 761, 763**
- cells
  - DRAM, **582, 583**
  - SRAM, **581**
- central processing units (CPUs), **9, 9–10**
  - Core i7. See **Core i7 microprocessors**
  - early instruction sets, **361**
  - effective cycle time, **602**
  - embedded, **363**
  - Intel. See **Intel microprocessors**
  - logic design. See **logic design**
  - many-core, **471**
  - multi-core, **16, 24–25, 168, 605, 972**
  - overview, **352–354**
  - pipelining. See **pipelining**
  - RAM, **384**

- sequential Y86 implementation. See [sequential Y86–64 implementation](#)
- superscalar, [26](#), [471](#), [518](#)
- trends, [602–603](#)
- Y86. See [Y86–64 instruction set architecture](#)
- Cerf, Vinton, [931](#)
- CERT (Computer Emergency Response Team), [100](#)
- `CF` [x86–64] carry flag condition code, [201](#), [306](#)
- CGI (common gateway interface) program, [953](#), [953–955](#)
- CGI adder function, [955](#)
- chains, proxy, [952](#)
- `char` [C] data types, [40](#), [61](#)
- character codes, [49](#)
- character devices, [892](#)
- `check_clients` function, [981](#), [984](#)
- child processes, [740](#)
  - creating, [741–743](#)
  - default behavior, [744](#)
  - error conditions, [745–746](#)
  - exit status, [745](#)
  - reaping, [743](#), [743–749](#)
  - `waitpid` function, [746–749](#)
- CI (cache set index), [823](#)
- circuits
  - combinational, [374](#), [374–380](#)
  - retiming, [421](#)
  - sequential, [381](#)
- CISC (complex instruction set computers), [361](#), [361–363](#)

- `%cl` [x86–64] low order 8 of register `%rcx`, **180**
- Clarke, Dave, **931**
- classes
  - data hazards, **435**
  - exceptions, **726–728**
  - instructions, **182**
  - size, **863**
  - storage, **994–995**
- clear bit in descriptor set macro, **978**
- clear descriptor set macro, **978**
- clear signal set instruction, **765**
- client-server model, **918, 918–919**
- `clienterror` [CS:APP] TINY helper function, **959–960**
- clients
  - client-server model, **918**
  - telnet, **21**
- clock signals, **381**
- clocked registers, **401–402**
- clocking in logic design, **381–384**
- `close` [Unix] close file, **894, 894–895**
- close operations for files, **891, 894–895**
- close shared library function, **702**
- `closedir` functions, **905**
- `cltq` [x86–64] Sign extend `%eax` to `%rax`, **185**
- `cmova` [x86–64] move if unsigned greater, **217**
- `cmovae` [x86–64] move if unsigned greater or equal, **217**
- `cmovb` [x86–64] move if unsigned less, **217**

- `cmovbe` [x86–64] move if unsigned less or equal, [217](#)
- `cmove` [Y86–64] move when equal, [357](#)
- `cmovg` [x86–64] move if greater, [217](#), [357](#)
- `cmovge` [x86–64] move if greater or equal, [217](#), [357](#)
- `cmovl` [x86–64] move if less, [217](#), [357](#)
- `cmovle` [x86–64] move if less or equal, [217](#), [357](#)
- `cmovna` [x86–64] move if not unsigned greater, [217](#)
- `cmovnae` [x86–64] move if unsigned greater or equal, [217](#)
- `cmovnb` [x86–64] move if not unsigned less, [217](#)
- `cmovnbe` [x86–64] move if not unsigned less or equal, [217](#)
- `cmovne` [x86–64] move if not equal, [217](#), [357](#)
- `cmovng` [x86–64] move if not greater, [217](#)
- `cmovnge` [x86–64] move if not greater or equal, [217](#)
- `cmovnl` [x86–64] move if not less, [217](#)
- `cmovnle` [x86–64] move if not less or equal, [217](#)
- `cmovns` [x86–64] move if nonnegative, [217](#)
- `cmovnz` [x86–64] move if not zero, [217](#)
- `cmovp` [x86–64] move if even parity, [324](#)
- `cmovs` [x86–64] move if negative, [217](#)
- `cmovz` [x86–64] move if zero, [217](#)
- `CMF` [instruction class] Compare, [202](#)
- `cmpb` [x86–64] compare byte, [202](#)
- `cmpl` [x86–64] compare double word, [202](#)
- `cmpq` [x86–64] compare double word, [202](#)
- `cmpw` [x86–64] compare word, [202](#)

- cmtest script, **465**
- CO (cache block offset), **823**
- coalescing blocks, **860**
  - with boundary tags, **851–854**
  - free, **850**
  - memory, **847**
- Cocke, John, **361**
- code
  - performance strategies, **561–562**
  - profilers, **562–564**
  - representing, **49–50**
  - self-modifying, **435**
  - Y86 instructions, **358, 359–360**
- code motion, **508**
- code segments, **696, 697–698**
- Cohen, Danny, **43**
- cold caches, **612**
- cold misses, **612**
- Cold War, **931**
- collectors, garbage, **839, 866**
  - basics, **866–867**
  - conservative, **867, 869–870**
  - Mark & Sweep, **867–870**
- column access strobe (CAS) requests, **583**

- column-major sum function, **636**
- combinational circuits, **374, 374–380**
- combinational pipelines, **412–414, 460–462**
- common gateway interface (CGI) program, **953, 953–955**
- Compaq Computer Corp. RISC processors, **363**
- compare byte instruction, **202**
- compare double precision, **306**
- compare double word instruction, **202**
- compare instructions, **202**
- compare single precision, **306**
- compare word instruction, **202**
- comparison operations for floating-point code, **306–309**
- compilation phase, **5**
- compilation systems, **6, 6–7**
- compile time, **670**
- compile-time interpositioning, **708–709**
- compiler drivers, **4, 671–672**
- compilers, **6, 164**
  - optimizing capabilities and limitations, **498–502**
  - process, **169–170**
  - purpose, **171**
- complement instruction, **192**
- complex instruction set computers (CISC), **361, 361–363**
- compulsory misses, **612**
- computation stages in pipelining, **421–422**
- computed goto, **233**
- Computer Emergency Response Team (CERT), **100**
- computer systems, **2**

- concurrency, **972**
  - ECF for, **723**
  - flow synchronizing, **776–778**
  - and parallelism, **24**
  - run, **733**
  - thread-level, **24–26**
- concurrent execution, **733**
- concurrent flow, **733, 733–734**
- concurrent processes, **15, 16**
- concurrent programming, **972–973**
  - deadlocks, **1027–1030**
  - with I/O multiplexing, **978–985**
  - library functions in, **1024–1025**
  - with processes, **973–977**
  - races, **1025–1027**
  - reentrancy issues, **1023–1024**
  - shared variables, **992–995**
  - summary, **1030**
  - threads, **985–992**
  - for parallelism, **1013–1018**
  - safety issues, **1020–1022**
- concurrent programs, **972**
- concurrent servers, **972**
  - based on prethreading, **1005–1013**
  - based on processes, **974–975**
  - based on threads, **991–992**
- condition code registers, **171**
- hazards, **435**



- SEQ timing, [401–402](#)
- condition codes, [201](#), [201–202](#)
  - accessing, [202–205](#)
  - x86–64, [201](#)
  - Y86–64, [355–357](#)
- condition variables, [1010](#)
- conditional branches, [172](#), [209](#)
  - assembly form, [211](#)
  - condition codes, [201–202](#)
  - condition control, [209–213](#)
  - moves, [214–220](#), [550–553](#)
  - `switch`, [232–238](#)
- conflict misses, [613](#), [622–624](#)
- `connect` [Unix] establish connection with server, [934](#), [934–935](#)
- connected descriptors, [936](#), [936–937](#)
- connections
  - EOF on, [948](#)
  - Internet, [925](#), [929–931](#)
  - I/O devices, [596–597](#)
  - persistent, [952](#)
- conservative garbage collectors, [867](#), [869–870](#)
- constant words in Y86–64, [359](#)
- constants
  - floating-point code, [304–305](#)
  - free lists, [856–857](#)
  - maximum and minimum values, [68](#)
  - multiplication, [101–103](#)
  - for ranges, [67–68](#)

- Unix, [746](#)
- content
  - dynamic, [953–954](#)
  - serving, [949](#)
  - Web, [948](#), [949–950](#)
- context switches, [16](#), [736–737](#)
- contexts, [736](#)
  - processes, [16](#), [732](#)
  - thread, [986](#), [993](#)
- `continue` command, [280](#)
- Control Data Corporation 6600 processor, [522](#)
- control dependencies in pipelining, [419](#), [429](#)
- control flow, [722](#)
- exceptional. See [exceptional control flow \(ECF\)](#)
  - logical, [732](#), [732–733](#)
  - machine-language procedures, [239](#)
- control hazards, [429](#)
- control logic blocks, [398](#), [398](#), [405](#), [426](#)
- control logic in pipelining, [455](#)
  - control mechanism combinations, [460–462](#)
  - control mechanisms, [459–460](#)
  - design testing and verifying, [465](#)
  - implementation, [462–464](#)
  - special cases, [455–457](#)
  - special conditions, [457–459](#)
- control structures, [200–201](#)
  - condition codes, [200–205](#)
  - conditional branches, [209–213](#)

- conditional move instructions, [214–220](#)
- jumps, [205–209](#)
- loops. See [loops](#)
- `switch` statements, [232–238](#)
- control transfer, [241–245](#), [722](#)
- controllers
  - disk, [595](#), [595–596](#)
  - I/O devices, [9](#)
  - memory, [583](#), [584](#)
- conventional DRAMs, [582–584](#)
- conversions
  - binary
  - with hexadecimal, [36–37](#)
  - signed and unsigned, [70–76](#)
  - to two's complement, [64](#), [72–73](#), [97](#)
  - to unsigned, [62–63](#)
  - floating point, [125](#), [296–301](#)
  - lowercase, [509–511](#)
  - number systems, [36–39](#)
- convert active socket to listening socket function, [935](#)
- convert application-to-network function, [926](#)
- convert double precision to integer instruction, [297](#)
- convert double precision to quad-word integer instruction, [297](#)
- convert double to single precision instruction, [299](#)
- convert host and service names function, [937](#), [937–940](#)
- convert host-to-network long function, [925](#)
- convert host-to-network short function, [925](#)
- convert integer to double precision instruction, [297](#)

- convert integer to single precision instruction, [297](#)
- convert network-to-application function, [926](#)
- convert network-to-host long function, [925](#)
- convert network-to-host short function, [925](#)
- convert packed single to packed double precision instruction, [298](#)
- convert quad-word integer to double precision instruction, [297](#)
- convert quad-word integer to single precision instruction, [297](#)
- convert quad word to oct word instruction, [198](#)
- convert single precision to integer instruction, [297](#)
- convert single precision to quad-word integer instruction, [297](#)
- convert single to double precision instruction, [298](#)
- convert socket address to host and service names function, [940](#), [940–942](#)
- `copy_elements` function, [100](#)
- `copy_file` descriptor function, [909](#)
- `copy_from_kernel` function, [86–87](#)
- copy-on-write technique, [835](#), [835–836](#)
- copying
  - bytes in memory, [133](#)
  - descriptor tables, [909](#)
  - text files, [900](#)
- Core 2 microprocessors, [168](#), [588](#)
- Core i7 microprocessors, [25](#)
  - abstract operation model, [525–531](#)
  - address translation, [826–828](#)
  - caches, [631](#)
  - Haswell, [507](#)
  - memory mountain, [641](#)

- Nehalem, [168](#)
- page table entries, [826–828](#)
- QuickPath interconnect, [588](#)
- virtual memory, [825–828](#)
- core memory, [757](#)
- cores in multi-core processors, [168](#), [605](#), [972](#)
- correct signal handling, [770–774](#)
- counting semaphores, [1003](#)
- CPE (cycles per element) metric, [502](#), [504](#), [507–508](#)
- `cpfile` [CS:APP] text file copy, [900](#)
- CPI (cycles per instruction)
  - five-stage pipelines, [471](#)
  - in performance analysis, [464–468](#)
- CPUs. See [central processing units \(CPUs\)](#)
- `cqto` [x86–64] convert quad word to oct word, [198](#), [199](#)
- CR (carriage return) characters, [892](#)
- CR3 register, [826](#)
- Cray 1 supercomputer, [353](#)
- create/change environment variable function, [752](#)
- create child process function, [740](#), [741–743](#)
- create thread function, [988](#)
- critical path analysis, [498](#)
- critical paths, [525](#), [529](#)
- critical sections in progress graphs, [1000](#)
- CS:APP
  - header files, [746](#)
  - wrapper functions, [738](#), [1041](#)
- `csapp.c` [CS:APP] CS:APP wrapper functions, [738](#), [1041](#)

- `csapp.h` [CS:APP] CS:APP header file, [738](#), [746](#), [1041](#)
- `csch` [Unix] Unix shell program, [753](#)
- CT (cache tags), [823](#)
- ctest script, [465](#)
- `ctime` function, [1024](#)
- `ctime_ts` [CS:APP] thread-safe non-reentrant wrapper for `ctime`, [1022](#)
- Ctrl+C key
  - nonlocal jumps, [785](#)
  - signals, [758](#), [761](#), [795](#)
- Ctrl+Z key, [761](#), [795](#)
- current working directory, [892](#)
- `cvtss2sd` [x86–64] convert double to single precision, [299](#)
- `cvtss2sd` [x86–64] convert single to double precision, [298](#)
- cycles per element (CPE) metric, [502](#), [504](#), [507–508](#)
- cycles per instruction (CPI)
  - five-stage pipelines, [471](#)
  - in performance analysis, [464–468](#)
- cylinders
  - disk, [591](#)
  - spare, [596](#)
- `%cx` [x86–64] low order 16 bits of register `%rcx`, [180](#)

- d-caches (data caches), [520](#), [631](#)
- data
  - conditional transfers, [214–220](#)
  - forwarding, [436–439](#), [437](#)
  - sizes, [39–42](#)
- data alignment, [273](#), [273–276](#)
- data caches (d-caches), [520](#), [631](#)
- data dependencies in pipelining, [419](#), [429–431](#)
- data-flow graphs, [525–530](#)
- data formats in machine-level programming, [177–179](#)
- data hazards, [429](#)
  - avoiding, [441–444](#)
  - classes, [435](#)
  - forwarding for, [436–439](#)
  - load/use, [439–441](#)
  - stalling, [433–436](#)
  - Y86–64 pipelining, [429–433](#)
- data memory in SEQ timing, [401](#)
- data movement instructions, [182–189](#)
- data references
  - locality, [606–607](#)
  - PIC, [704–705](#)
- `.data` section, [674](#)
- data segments, [696](#)
- data structures, [265](#)
  - data alignment, [273–276](#)
  - structures, [265–269](#)
  - unions, [269–273](#)

- data transfer, procedures, **245–248**
- data types. See **types**
- database transactions, **919**
- datagrams, **924**
- DDD debugger with graphical user interface, **279**
- DDR SDRAM (double data-rate synchronous DRAM), **586**
- deadlocks, **1027, 1027–1030**
- deallocate heap storage function, **841**
- `.debug` section, **675**
- debugging, **279–280**
- DEC [instruction class] decrement, **192**
- decimal notation, **32**
- decimal system conversions, **37–39**
- declarations
  - arrays, **255–256, 263**
  - pointers, **41**
  - public and private, **677**
  - structures, **265–269**
  - unions, **269–273**
- decode stage
  - instruction processing, **385, 387–397**
  - PIPE processor, **449–453**
  - sequential processing, **400**
  - Y86–64 implementation, **406–408**
  - Y86–64 pipelining, **423**
- decoding instructions, **519**
- decrement instruction, **192, 194**
- deep copies, **1024**



- deep pipelining, [418–419](#)
- default actions with signal, [762](#)
- default behavior for child processes, [744](#)
- default function code, [404](#)
- deferred coalescing, [850](#)
- `#define` [C] preprocessor directive
- `delete` command, [280](#)
- delete environment variable function, [752](#)
- DELETE method in HTTP, [951](#)
- delete signal from signal set instruction, [765](#)
- delivering signals, [758](#)
- delivery mechanisms for protocols, [922](#)
- demand paging, [810](#)
- demand-zero pages, [833](#)
- demangling process (C++ and Java), [680](#), [680](#)
- denormalized floating-point value, [114](#), [114–116](#)
- dependencies
  - control in pipelining systems, [419](#), [429](#)
  - data in pipelining systems, [419](#), [429–431](#)
  - reassociation transformations, [542](#)
  - write/read, [557–559](#)
- dereferencing pointers, [48](#), [188](#), [257](#), [277](#), [870–871](#)
- descriptor sets, [977](#), [978](#)
- descriptor tables, [907](#), [909](#)
- descriptors, [891](#)
  - connected and listening, [936](#), [936–937](#)
  - socket, [934](#)
- destination hosts, [922](#)

- detach thread function, [990](#)
- detached threads, [989](#)
- detaching threads, [989–990](#)
- `%di` [x86–64] low order 16 bits of register `%rdi`, [180](#)
- diagrams
  - hardware, [398](#)
  - pipeline, [413](#)
- Digital Equipment Corporation, [56](#)
- Dijkstra, Edsger, [1001–1002](#)
- `%dil` [x86–64] low order 8 of register `%rdi`, [180](#)
- DIMM (dual inline memory module), [584](#)
- direct jumps, [206](#)
- direct-mapped caches, [617](#)
  - conflict misses, [622–624](#)
  - example, [619–621](#)
  - line matching, [618](#)
  - line replacement, [619](#)
  - set selection, [618](#)
  - word selection, [619](#)
- direct memory access (DMA), [11](#), [598](#)
- directives, assembler, [176](#), [366](#)
- directories
  - description, [891](#), [891–892](#)
  - reading contents, [905–906](#)
- directory streams, [905](#)
- dirty bits
  - in cache, [630](#)
  - Core i7, [827](#)

- dirty pages, **827**
- `disas` command, **280**
- disassemblers, **44, 69, 173, 173–174**
- disks, **589**
  - accessing, **597–600**
  - anatomy, **600**
  - backups, **611**
  - capacity, **591, 591–592**
  - connecting, **596–597**
  - controllers, **595, 595–596**
  - geometry, **590–591**
  - logical blocks, **595–596**
  - operation, **592–595**
  - trends, **602**
- distributing software, **701**
- division
  - floating-point, **302**
  - instructions, **198–200**
  - Linux/x86–64 system errors, **729**
  - by powers of 2, **103–107**
  - `divq` [x86–64] unsigned divide, **198, 200**
  - `%dl` [x86–64] low order 8 of register `%rdx`, **180**
  - `dlclose` [Unix] close shared library, **702**
  - `dlderror` [Unix] report shared library error, **702**
- DLL (dynamic link library), **699**
- `dlopen` [Unix] open shared library, **701**
- `dlsym` [Unix] get address of shared library symbol, **702**

- DMA (direct memory access), [11](#), [598](#)
- DMA transfer, [598](#)
- DNS (domain name system), [928](#)
- `do` [C] variant of `while` loop, [220–223](#)
- `do-while` statement, [220](#)
- `doit` [CS:APP] TINY helper function, [956](#), [958](#), [958–959](#)
- dollar signs (\$) for immediate operands, [181](#)
- domain names, [925](#), [927–929](#)
- domain name system (DNS), [928](#)
- `dotprod` [CS:APP] vector dot product, [622](#)
- dots (.) in dotted-decimal notation, [926](#)
- dotted-decimal notation, [926](#), [926](#)
- `double` [C] double-precision floating point, [124](#), [125](#)
- `double` [C] integer data type, [41](#)
- double data-rate synchronous DRAM (DDR SDRAM), [586](#)
- `double` floating-point declaration, [178](#)
- double-precision addition instruction, [302](#)
- double-precision division instruction, [302](#)
- double-precision maximum instruction, [302](#)
- double-precision minimum instruction, [302](#)
- double-precision multiplication instruction, [302](#)
- double-precision representation C, [41](#), [124–126](#)
  - IEEE, [113](#), [113](#)
  - machine-level data, [178](#)
- double-precision square root instruction, [302](#)
- double-precision subtraction instruction, [302](#)
- double word to quad word instruction, [199](#)

- double words, [177](#)
- DRAM. See [dynamic RAM \(DRAM\)](#)
- DRAM arrays, [582](#)
- DRAM cells, [582](#), [583](#)
- drivers, compiler, [4](#), [671–672](#)
- dual inline memory module (DIMM), [584](#)
- `dup2` [Unix] copy file descriptor, [909](#)
- duplicate symbol names, [680–684](#)
- dynamic code, [290](#)
- dynamic content, [701](#), [953–954](#)
- dynamic link libraries (DLLs), [699](#)
- dynamic linkers, [699](#)
- dynamic linking, [699](#), [699–701](#)
- dynamic memory allocation
  - allocated block placement, [849](#)
  - allocator design, [854–856](#)
  - allocator requirements and goals, [844–845](#)
  - coalescing free blocks, [850–851](#)
  - coalescing with boundary tags, [851–854](#)
  - explicit free lists, [862–863](#)
  - fragmentation, [846](#)
  - heap memory requests, [850](#)
  - implementation issues, [846–847](#)
  - implicit free lists, [847–849](#)
  - `malloc` and `free` functions, [840–843](#)
  - overview, [839–840](#)
  - purpose, [843–844](#)
  - segregated free lists, [863–865](#)

- splitting free blocks, **849–850**
- dynamic memory allocators, **839–840**
- dynamic RAM (DRAM), **9, 582**
  - caches, **806, 808, 808–809**
  - conventional, **582–584**
  - enhanced, **585–586**
  - historical popularity, **586**
  - modules, **584, 585**
  - vs. SRAM, **582**
  - trends, **602–603**
- dynamic Web content, **949**
- `%dx` [x86–64] low order 16 bits of register `%rdx`, **180**

[OceanofPDF.com](http://OceanofPDF.com)

- E-way set associative caches, [624–625](#)
- `%eax` [x86–64] low order 32 bits of register `%rax`, [180](#)
- `%ebp` [x86–64] low order 32 bits of register `%rbp`, [180](#)
- `%ebx` [x86–64] low order 32 bits of register `%rbx`, [180](#)
- ECF. See [exceptional control flow \(ECF\)](#)
- ECHILD return code, [746–747](#)
- `echo` [CS:APP] read and echo input lines, [947](#)
- `echo` function, [281–282](#), [287](#)
- `echo_cnt` [CS:APP] counting version of `echo`, [1012](#)
- `echoclient.c` [CS:APP] echo client, [944–945](#)
- `echoserveri.c` [CS:APP] iterative echo server, [936–937](#), [947](#)
- `echoservert.c` [CS:APP] concurrent echo server based on threads, [991](#)
- `echoservert_pre.c` [CS:APP] prethreaded concurrent echo server, [1011](#)
- `%ecx` [x86–64] low order 32 bits of register `%rcx`, [180](#)
- `%edi` [x86–64] low order 32 bits of register `%rdi`, [180](#)
- EDO DRAM (extended data out DRAM), [586](#)
- `%edx` [x86–64] low order 32 bits of register `%rdx`, [180](#)
- EEPROMs (electrically erasable programmable ROMs), [587](#)
- effective addresses, [181](#), [690](#)
- effective cycle time, [602](#)
- efficiency of parallel programs, [1019](#), [1019](#)
- EINTR return code, [746](#)
- electrically erasable programmable ROMs (EEPROMs), [587](#)
- ELF. See [executable and linkable format \(ELF\)](#)

- EM64T processors, [168](#)
- embedded processors, [363](#)
- encapsulation, [922](#)
- encodings in machine-level programming, [169–170](#)
  - code examples, [172–175](#)
  - code overview, [170–171](#)
  - formatting, [175–177](#)
  - Y86–64 instructions, [358–360](#)
- end-of-file (EOF) condition, [891](#), [948](#)
- end of line (EOL) indicators, [892](#)
- entry points, [696](#), [697–698](#)
- environment variables lists, [751–752](#)
- EOF (end-of-file) condition, [891](#), [948](#)
- EOL (end of line) indicators, [892](#)
- ephemeral ports, [930](#)
- epilogue blocks, [855](#)
- EPIPE error return code, [964](#)
- erasable programmable ROMs (EPROMs), [587](#)
- `errno` [Unix] Unix error variable, [1042](#)
- error-correcting codes for memory, [582](#)
- error handling
  - system calls, [737–738](#)
  - Unix systems, [1042–1043](#)
  - wrappers, [738](#), [1041](#), [1043–1045](#)
- error-reporting functions, [737](#)
- errors
  - child processes, [745–746](#)
  - link-time, [7](#)



- off-by-one, [872](#)
- race, [776](#), [776–778](#)
- reporting, [1043](#)
- synchronization, [995](#)
- `%esi` [x86–64] low order 32 bits of register `%rsi`, [180](#)
- `%esp` [x86–64] low order 32 bits of stack pointer register `%rsp`, [180](#)
- establish connection with server functions, [934](#), [934–935](#), [942–944](#)
- establish listening socket function, [944](#), [944](#)
- etest script, [465](#)
- Ethernet segments, [920](#), [920](#)
- Ethernet technology, [920](#)
- EUs (execution units), [518](#), [520](#)
- `eval` [CS:APP] shell helper routine, [754](#), [755](#)
- event-driven programs, [980](#)
  - based on I/O multiplexing, [980–985](#)
  - based on threads, [1013](#)
- events, [723](#)
  - scheduling, [763](#)
  - state machines, [980](#)
- evicting blocks, [612](#)
- exabytes, [39](#)
- excepting instructions, [445](#)
- exception handlers, [724](#), [724](#)
- exception handling
  - in instruction processing, [385](#)
  - Y86–64, [363–364](#), [444–447](#)

- exception numbers, [725](#)
- exception table base registers, [725](#)
- exception tables, [725](#), [725](#)
- exceptional control flow (ECF), [722](#)
  - exceptions, [723–731](#)
  - importance, [722–723](#)
  - nonlocal jumps, [781–786](#)
- process control. See [processes](#)
  - signals. See [signals](#)
  - summary, [787](#)
  - system call error handling, [737–738](#)
- exceptions, [723](#)
  - anatomy, [723–724](#)
  - asynchronous, [726](#)
  - classes, [726–728](#)
  - data alignment, [276](#)
  - handling, [724–726](#)
  - Linux/x86–64 systems, [729–731](#)
  - status code for, [404](#)
  - synchronous, [727](#)
  - Y86, [356](#)
- exclamation points ! for NOT operation, [373](#)
- EXCLUSIVE-OR Boolean operation, [51](#)
- exclusive-or instruction
  - x86–64, [192](#)
  - Y86–64, [356](#)
- EXCLUSIVE-OR operation in execute stage, [408](#)
- exclusive-or packed double precision instruction, [305](#)

- exclusive-or packed single precision instruction, **305**
- executable and linkable format (ELF), **673**
  - executable object files, **695–696**
  - header tables, **674, 696**
  - headers, **674–675**
  - relocation, **690**
  - symbol tables, **675–679**
- executable code, **170**
- executable object files, **4**
  - creating, **672**
  - description, **672**
  - fully linked, **696**
  - loading, **697–698**
  - running, **7–8**
- executable object programs, **4**
- execute access, **289**
- execute disable bit, **827**
- execute stage
  - instruction processing, **385, 387–397**
  - PIPE processor, **453–454**
  - sequential processing, **400**
  - sequential Y86–64 implementation, **408–409**
  - Y86–64 pipelining, **423**
- execution
  - concurrent, **733**
  - parallel, **734**
  - speculative, **519, 519, 549–550**
  - tracing, **387, 394–395, 403**

- execution code regions, **289–290**
- execution units (EUs), **518, 520**
- `execve` [Unix] load program, **750**
  - arguments and environment variables, **750–752**
  - child processes, **699, 701**
  - loading programs, **697**
  - running programs, **753–756**
  - virtual memory, **836–837**
- `exit` [C Stdlib] terminate process, **739**
- exit status, **739, 745**
- expanding bit representation, **76–80**
- expansion slots, **597**
- explicit allocator requirements and goals, **844–845**
- explicit dynamic memory allocators, **839–840**
- explicit free lists, **862–863**
- explicit thread termination, **988**
- explicit waiting for, signals, **778–781**
- explicitly reentrant functions, **1023**
- exploit code, **284**
- exponents in floating-point representation, **112**
- `extend_heap` [CS:APP] allocator: extend heap, **858**
- extended data out DRAM (EDO DRAM), **586**
- extended precision floating-point representation, **137, 137**
- external exceptions in pipelining, **444**
- external fragmentation, **846, 846**

- fall through in `switch` statements, **233**
- false fragmentation, **850**
- fast page mode DRAM (FPM DRAM), **585**
- fault exception class, **726**
- faulting instructions, **727**
- faults, **728**
  - Linux/x86–64 systems, **729, 832–833**
  - Y86–64 pipelining caches, **470**
- `FD_CLR` [Unix] clear bit in descriptor set, **977, 978**
- `FD_ISSET` [Unix] bit turned on in descriptor set, **977, 978, 980**
- `FD_SET` [Unix] set bit in descriptor set, **977, 978**
- `FD_ZERO` [Unix] clear descriptor set, **977, 978**
- feedback in pipelining, **419–421, 425**
- feedback paths, **396, 419**
- fetch file metadata function, **903**
- fetch stage
  - instruction processing, **384, 387–397**
  - PIPE processor, **447–449**
  - SEQ, **404–406**
  - sequential processing, **400**
  - Y86–64 pipelining, **423**
- fetches, locality, **607–608**
- `fgets` function, **282**
- Fibonacci (Pisano), **32**
- field-programmable gate arrays (FPGAs), **467**
- FIFOs, **977**
- file descriptors, **891**
- file position, **891**

- file tables, [736](#), [906](#)
- FILE type, [911](#)
- filenames, [891](#)
- files, [19](#)
  - as abstraction, [27](#)
  - anonymous, [833](#)
  - binary, [3](#)
  - metadata, [903–904](#)
  - object. See [object files](#)
  - register, [10](#), [171](#), [358–359](#), [382–383](#), [401](#), [521](#)
  - regular, [833](#)
  - sharing, [906–908](#)
  - system-level I/O. See [system-level I/O](#)
  - types, [891–893](#)
  - Unix, [890](#), [890–891](#)
  - FINGER command, [284](#)
  - `fingerd` daemon, [284](#)
  - `finish` command, [280](#)
- firmware, [587](#)
- first-fit block placement policy, [849](#), [849](#)
- first-level domain names, [927](#)
- first readers-writers problem, [1008](#)
- fits, segregated, [863](#), [864–865](#)
- five-stage pipelines, [471](#)
- fixed-size arithmetic, [85](#)
- fixed-size arrays, [260–262](#)
- fixed-size integer types, [41](#), [67](#)
- flash memory, [587](#)

- flash translation layers, [600–601](#)
- flat addressing, [167](#)
- `float` [C] single-precision floating point, [124](#)
- `float` floating-point declaration, [178](#)
- floating-point code
  - architecture, [293](#), [293–296](#)
  - arithmetic operations, [302–304](#)
  - bitwise operations, [305–306](#)
  - comparison operations, [306–309](#)
  - constants, [304–305](#)
  - movement and conversion operations, [296–301](#)
  - observations, [309](#)
  - in procedures, [301–302](#)
- floating-point representation and programs, [108–109](#)
  - arithmetic, [33](#)
  - C, [124–126](#)
  - denormalized values, [114](#), [114–116](#)
  - encodings, [32](#)
  - extended precision, [137](#), [137](#)
  - fractional binary numbers, [109–112](#)
  - IEEE, [112–114](#)
  - normalized value, [113–114](#)
  - operations, [122–124](#)
  - overflow, [127](#)
  - pi, [140](#)
  - rounding, [120](#), [120–122](#)
  - special values, [115](#)
  - support, [40](#)

- x87 processors, [167](#)
- flows
  - concurrent, [733](#), [733–734](#)
  - control, [722](#)
  - logical, [732](#), [732–733](#)
  - parallel, [734](#)
  - synchronizing, [776–778](#)
- flushed instructions, [522](#)
- `FNONE` [Y86–64] default function code, [404](#)
- footers of blocks, [851](#)
- `for` [C] general loop statement, [228–232](#)
  - guarded-do translation, [225](#)
  - jump-to-middle translation, [223](#)
- forbidden regions, [1003](#)
- foreground processes, [753](#)
- `fork` [Unix] create child process, [740](#)
  - child processes, [701](#)
  - example, [741–743](#)
  - running programs, [753–756](#)
  - virtual memory, [836](#)
- `fork.c` [CS:APP] `fork` example, [741](#)
- formal verification in pipelining, [466](#)
- format strings, [47](#)
- formats for machine-level data, [177–179](#)
- formatted disk capacity, [596](#)
- formatted printing, [47](#)
- formatting
  - disks, [596](#)



- machine-level code, [175–177](#)
- forwarding
  - for data hazards, [436–439](#)
  - load, [477](#)
- forwarding priority, [451–452](#)
- FPGAs (field-programmable gate arrays), [467](#)
- FPM DRAM (fast page mode DRAM), [585](#)
- `fprintf` [C Stdlib] function, [47](#)
- fractional binary numbers, [109–112](#)
- fractional floating-point representation, [112–120](#), [137](#)
- fragmentation, [846](#)
  - dynamic memory allocation, [846](#)
  - false, [850](#)
- frame pointers, [290](#)
- frames
  - Ethernet, [920](#)
  - stack, [240](#), [240–241](#), [276](#), [290–293](#)
- free blocks, [839](#)
  - coalescing, [850–851](#)
  - splitting, [849–850](#)
- free bounded buffer function, [1007](#)
- `free` [C Stdlib] deallocate heap storage, [841](#), [841–843](#)
  - interpositioning libraries, [708](#)
  - wrappers for, [711](#)
- free heap block function, [860](#)
- free heap blocks, referencing data in, [874–875](#)
- free lists
  - creating, [857–859](#)

- dynamic memory allocation, [847–849](#)
- explicit, [862–863](#)
- implicit, [848](#)
- manipulating, [856–857](#)
- segregated, [863–865](#)
- free software, [6](#)
- free up getaddrinfo resources function, [937](#)
- `freeaddrinfo` [Unix] free up getaddrinfo resources, [937](#), [938](#)
- FreeBSD open-source operating system, [86–87](#)
- freeing blocks, [860](#)
- Freescale
  - processor family, [352](#)
  - RISC design, [361](#)
  - front side bus (FSB), [588](#)
  - `fstat` [Unix] fetch file metadata, [903](#)
- full duplex connections, [929](#)
- full duplex streams, [912](#)
- fully associative caches, [626](#)
  - line matching and word selection, [627–628](#)
  - set selection, [627](#)
- fully linked executable object files, [696](#)
- fully pipelined functional units, [523](#)
- function calls
  - performance strategies, [561](#)
  - PIC, [705–707](#)
- function part in Y86–64 instruction specifier, [358](#)
- functional units, [520–521](#), [523–524](#)
- functions

- pointers to, **278**
- reentrant, **766**, **1023**
- static libraries, **684–688**
- system-level, **730**
- thread-safe and thread-unsafe, **1020**, **1020–1022**
- wrapper, **711**
- in Y86 instructions, **359**

[OceanofPDF.com](http://OceanofPDF.com)

- `gai_error` [CS:APP] reports GAI-style errors, [1043](#)
- `gai_strerror` [Unix] print getaddrinfo error message, [938](#)
- GAI-style error handling, [1042](#), [1042–1043](#)
- gaps between disk sectors, [590](#), [596](#)
- garbage, [866](#)
- garbage collection, [840](#), [866](#)
  - garbage collectors, [840](#), [866](#)
  - basics, [866–867](#)
  - conservative, [867](#), [869–870](#)
  - Mark&Sweep, [867–870](#)
  - overview, [865–866](#)
- gates, logic, [373](#)
- gcc (GNU compiler collection) compiler
  - code formatting, [175–176](#)
  - inline assembly, [178](#)
  - options, [35](#)
  - working with, [168–169](#)
  - GDB GNU debugger, [173](#), [279](#), [279–280](#)
- general protection faults, [729](#)
- general-purpose registers, [179](#), [17–180](#)
- geometry of disks, [590–591](#)
- get address of shared library symbol function, [702](#)
- "get from" operator (C++), [890](#)
- GET method in HTTP, [951](#)
- get parent process ID function, [739](#)
- get process group ID function, [759](#)
- get process ID function, [739](#)
- get thread ID function, [988](#)

- `getaddrinfo` [Unix] convert host and service names, [937](#), [937–940](#)
- `getenv` [C Stdlib] read environment variable, [751](#)
- `gethostbyaddr` [Unix] get DNS host entry, [1024](#)
- `gethostbyname` [Unix] get DNS host entry, [1024](#)
- `getnameinfo` [Unix] convert socket address to host and service names, [940](#), [940–942](#)
- `getpeername` function [C Stdlib] security vulnerability, [86–87](#)
- `getpgrp` [Unix] get process group ID, [759](#)
- `getpid` [Unix] get process ID, [739](#)
- `getppid` [Unix] get parent process ID, [739](#)
- `getrusage` [Unix] function, [811](#)
- `gets` function, [279](#), [281–282](#)
- GHz (gigahertz), [502](#)
- giga-instructions per second (GIPS), [413](#)
- gigabytes, [592](#)
- gigahertz (GHz), [502](#)
- GIPS (giga-instructions per second), [413](#)
- global IP Internet. See [Internet](#)
- Global Offset Table (GOT), [705](#), [705–707](#)
- global symbols, [675](#)
- global variable mapping, [994–995](#)
- GNU compiler collection. See [gcc \(GNU compiler collection\) compiler](#)
- GNU project, [6](#)
- GOT (global offset table), [705](#), [705–707](#)
- `goto` [C] control transfer statement, [210](#), [233](#)

- goto code, **210**
- GPROF Unix profiler, **562**, **562–563**
- gradual underflow, **115**
- granularity of concurrency, **985**
- graphic user interfaces for debuggers, **279**
- graphics adapters, **596**
- graphs
  - data-flow, **525–530**
  - process, **741**, **742**
  - progress. See **progress graphs**
  - reachability, **866**
- greater than signs >
  - deferencing operation, **266**
  - "get from" operator, **890**
  - right hoinkies, **909**
- groups
  - abelian, **89**
  - process, **759**
- guard values, **286**
- guarded-do translation, **225**

- `.h` header files, [686](#)
- half-precision floating-point representation, [137](#), [137](#)
- `halt` [Y86–64] halt instruction execution, [357](#)
  - code for, [404–405](#)
  - exceptions, [364](#), [444–447](#)
  - in pipelining, [462](#)
- handlers
  - exception, [724](#), [724](#)
  - interrupt, [726](#)
  - signal, [758](#), [763](#)
- handling signals
  - blocking and unblocking, [764–765](#)
  - portable, [774–775](#)
- hardware caches. See [caches and cache memory](#)
- hardware control language (HCL), [372](#)
  - Boolean expressions, [374–375](#)
  - integer expressions, [376–380](#)
  - logic gates, [373](#)
- hardware description languages (HDLs), [373](#), [467](#)
- hardware exceptions, [724](#)
- hardware interrupts, [726](#)
- hardware management, [14–15](#)
- hardware organization, [8](#)
  - buses, [8](#)
  - I/O devices, [9](#)
  - main memory, [9](#)
  - processors, [9–10](#)
- hardware registers, [381–384](#)

- hardware structure for Y86–64, **396–400**
- hardware units, **396–398, 401**
- hash tables, **567–568**
- Haswell microarchitecture, **825**
- Haswell microprocessors, **168, 215, 294, 507, 521, 523**
- hazards in pipelining, **354, 429**
  - avoiding, **441–444**
  - classes, **435**
  - forwarding for, **436–439**
  - load/use, **439–441**
  - overview, **429–433**
  - stalling for, **433–436**
- HCL (hardware control language), **372**
  - Boolean expressions, **374–375**
  - integer expressions, **376–380**
  - logic gates, **373**
- HDLs (hardware description languages), **373, 467**
- head crashes, **593**
- HEAD method in HTTP, **951**
- header files
  - static libraries, **687**
  - system, **746**
- header tables in ELF, **674, 696**
- headers
  - blocks, **847**
  - Ethernet, **920**
  - request, **951**
  - response, **952**



- heap, [18](#), [18–19](#), [839](#)
  - dynamic memory allocation, [839–840](#)
  - Linux systems, [697](#)
  - referencing data in, [874–875](#)
  - requests, [850](#)
  - `hello` [CS:APP] C hello program, [2](#), [10–12](#)
  - `help` command, [280](#)
- helper functions, sockets interface, [942–944](#)
- Hennessy, John, [361](#), [471](#)
- heterogeneous data structures, [265](#)
  - data alignment, [273–276](#)
  - structures, [265–269](#)
  - unions, [269–273](#)
- hexadecimal (hex) notation, [36](#), [36–39](#)
- hierarchies
  - domain name, [927](#)
  - storage devices, [14](#), [14](#), [609–614](#)
- high-level design performance strategies, [561](#)
- hit rates, [631](#)
- hit time, [631](#)
- hits
  - cache, [612](#), [631](#)
  - write, [630](#)
  - `hlt` [x86–64] halt instruction execution, [357](#)
  - `HLT` [Y86–64] status code indicating `halt` instruction, [364](#)
- hoinkies, [909](#), [910](#)
- holding mutexes, [1003](#)
- Horner, William, [530](#)

- Horner's method, [530](#)
- host bus adapters, [597](#)
- host bus interfaces, [597](#)
- host entries, [928](#)
- host information program command, [926](#)
- HOSTNAME command, [926](#)
- hosts
  - client-server model, [919](#)
  - network, [922](#)
  - number of, [930](#)
  - sockets interface, [937–942](#)
- htest script, [465](#)
- HTML (hypertext markup language), [948](#), [948–949](#)
- `htonl` [Unix] convert host-to-network long, [925](#)
- `htons` [Unix] convert host-to-network short, [925](#)
- HTTP. See [hypertext transfer protocol \(HTTP\)](#)
- hubs, [920](#)
- hyperlinks, [948](#)
- hypertext markup language (HTML), [948](#), [948–949](#)
- hypertext transfer protocol (HTTP), [948](#)
  - dynamic content, [953–954](#)
  - methods, [951–952](#)
  - requests, [951](#), [951–952](#)
  - responses, [952](#), [952–953](#)
  - transactions, [950–951](#)
- hyperthreading, [24](#), [168](#)
- Hyper Transport interconnect, [588](#)

[OceanofPDF.com](http://OceanofPDF.com)

- i-caches (instruction caches), [518](#), [631](#)
- `.i` source files, [671](#)
- i386 microprocessor, [167](#)
- i486 microprocessor, [167](#)
- IA32 (Intel Architecture 32-bit) microprocessors, [45](#), [168](#)
  - machine language, [165–166](#)
  - registers, [179–180](#)
- `iaddq` [Y86–64] immediate add, [369](#)
- IBM
  - Freescale microprocessors, [352](#), [361](#)
  - out-of-order processing, [522](#)
  - RISC design, [361–363](#)
- `ICALL` [Y86–64] instruction code for `call` instruction, [404](#)
- ICANN (Internet Corporation for Assigned Names and Numbers), [927](#)
- icode (instruction code), [384](#), [405](#)
- ICUs (instruction control units), [518](#)
- identifiers, register, [358](#)
- `idivl` [x86–64] signed divide, [199](#)
- `idivq` [x86–64] signed divide, [198](#)
- IDs (identifiers)
  - processes, [739–740](#)
  - register, [358–359](#)
- IEEE. See [Institute for Electrical and Electronics Engineers \(IEEE\)](#)
- `if` [C] conditional statement, [211–213](#)
- ifun (instruction function), [384](#), [405](#)

- `IHALT` [Y86–64] instruction code for `halt` instruction, [404](#)
- `IIRMOVQ` [Y86–64] instruction code for `irmovq` instruction, [404](#)
- `ijk` matrix multiplication, [644–646](#), [645](#)
- `IJXX` [Y86–64] instruction code for jump instructions, [404](#)
- `ikj` matrix multiplication, [644–646](#), [645](#)
- illegal instruction exceptions, [404](#)
- `imem_error` signal, [405](#)
- immediate add instruction, [369](#)
- immediate coalescing, [850](#)
- immediate offset, [181](#)
- immediate operands, [181](#)
- immediate to register move instruction, [356](#)
- implicit dynamic memory allocators, [840](#)
- implicit free lists, [847–849](#), [848](#)
- implicit thread termination, [988](#)
- implicitly reentrant functions, [1023](#)
- implied leading 1 representation, [114](#)
- `IMRMOVQ` [Y86–64] instruction code for `mrmovq` instruction, [404](#)
- `IMUL` [instruction class] multiply, [192](#)
- `imulq` [x86–64] signed multiply, [198](#), [198](#)
- `in` [HCL] set membership test, [381](#)
- `in_addr` [Unix] IP address structure, [925](#)
- `INC` [instruction class] increment, [192](#)
- include files, [686](#)
- `#include` [C] preprocessor directive, [170](#)
- `incq` instruction, [194](#)
- increment instruction, [192](#), [194](#)

- indefinite integer values, [125](#)
- `index.html` file, [950](#)
- index registers, [181](#)
- indexes for direct-mapped caches, [622–624](#)
- indirect jumps, [206](#), [234](#)
- inefficiencies in loops, [508–512](#)
- `inet_ntoa` [Unix] convert network-to-application, [1024](#)
- `inet_ntop` [Unix] convert network-to-application, [926](#)
- `inet_pton` [Unix] convert application-to-network, [926](#)
- infinity
  - constants, [124](#)
  - representation, [114–115](#)
- `info frame` command, [280](#)
- `info registers` command, [280](#)
- information, [2–4](#)
- information access with x86–64
  - registers, [179–180](#)
  - data movement, [182–189](#)
  - operand specifiers, [180–182](#)
- information storage, [34](#)
  - addressing and byte ordering, [42–49](#)
  - bit-level operations, [54–56](#)
  - Boolean algebra, [50–53](#)
  - code, [49–50](#)
  - data sizes, [39–42](#)
  - disks. See [disks](#)
  - floating point. See [floating-point representation and programs](#)

- hexadecimal, [36–39](#)
- integers. See [integers](#)
- locality. See [locality](#)
- logical operations, [56–57](#)
- memory. See [memory](#)
- segregated, [863](#)
- shift operations, [57–59](#)
- strings, [49](#)
- summary, [648](#)
- `init` function, [743](#)
- `init_pool` function, [981](#), [983](#)
- initial state in progress graphs, [999](#)
- initialize nonlocal handler jump function, [783](#)
- initialize nonlocal jump functions, [783](#)
- initialize read buffer function, [898](#), [900](#)
- initialize semaphore function, [1002](#)
- initialize thread function, [990](#)
- initializing threads, [990](#)
- inline assembly, [178](#)
- inline substitution, [501](#)
- inlining, [501](#)
- `INOP` [Y86–64] instruction code for `nop` instruction, [404](#)
- input events, [980](#)
- input/output. See [I/O \(input/output\)](#)
- insert item in bounded buffer function, [1007](#)
- install portable handler function, [775](#)
- installing signal handlers, [763](#)
- Institute for Electrical and Electronics Engineers (IEEE)

- description, [109](#)
- floating-point representation and programs, [112–114](#)
- denormalized, [114](#)
- normalized, [113–114](#)
- special values, [115](#)
- Standard 754, [109](#)
- standards, [109](#)
- Posix standards, [16](#)
- `instr_valid` signal, [405–406](#)
- instruction caches (i-caches), [518](#), [631](#)
- instruction code (icode), [384](#), [405](#)
- instruction control units (ICUs), [518](#)
- instruction function (ifun), [384](#), [405](#)
- instruction-level parallelism, [26](#), [497](#), [518](#), [562](#)
- instruction memory in SEQ timing, [401](#)
- instruction set architectures (ISAs), [10](#), [27](#), [170](#), [352](#)
- instruction set simulators, [366](#)
- instructions
  - classes, [182](#)
  - decoding, [518](#)
  - excepting, [445](#)
  - fetch locality, [607–608](#)
- issuing, [427–428](#)
  - jump, [10](#), [205–209](#)
  - load, [10](#)
  - low-level. See [machine-level programming](#)
  - move, [214–220](#), [550–553](#)
  - operate, [10](#)



- pipelining, [468–469](#), [549](#)
- privileged, [735](#)
- store, [10](#)
- update, [9–10](#)
- Y86–64. See [Y86–64 instruction set architecture](#)
- instructions per cycle (IPC), [471](#)
- `int` [C] integer data type, [40](#)
- `int` [HCL] integer signal, [376](#)
- `int` data types, integral, [61](#)
- `INT_MAX` constant, maximum signed integer, [68](#)
- `INT_MIN` constant, minimum signed integer, [68](#)
- `int32_t` [Unix] fixed-size, [41](#)
- integer arithmetic, [84](#), [192](#)
  - division by powers of 2, [103–107](#)
  - multiplication by constants, [101–103](#)
  - overview, [107–108](#)
  - two's complement addition, [90–95](#)
  - two's complement multiplication, [97–101](#)
  - two's complement negation, [95](#)
  - unsigned addition, [84–90](#)
- integer bits in floating-point representation, [137](#)
- integer expressions in HCL, [376–380](#)
- integer indefinite values, [125](#)
- integer operation instruction, [404](#)
- integer registers in x86–64, [179–180](#)
- integers, [32](#), [59–60](#)
  - arithmetic operations. See [integer arithmetic](#)
  - bit-level operations, [54–56](#)

- bit representation expansion, [76–80](#)
- byte order, [43–44](#)
- data types, [60–62](#)
- shift operations, [57–59](#)
- signed and unsigned conversions, [70–76](#)
- signed vs. unsigned guidelines, [83–84](#)
- truncating, [81–82](#)
- two's complement representation, [64–70](#)
- unsigned encoding, [62–64](#)
- integral data types, [60](#), [60–62](#)
- integration of caches and VM, [817](#)
- Intel assembly-code format, [177](#), [294](#), [311](#)
- Intel Corporation, [165](#)
- Intel microprocessors
  - 8086, [26](#), [167](#)
  - 80286, [167](#)
  - Core 2, [168](#), [588](#)
  - Core i7. See [Core i7 microprocessors](#)
  - data alignment, [276](#)
  - evolution, [167–168](#)
  - floating-point representation, [137](#)
  - Haswell, [168](#), [215](#), [294](#), [523](#)
  - i386, [167](#)
  - i486, [167](#)
  - northbridge and southbridge chipsets, [588](#)
  - out-of-order processing, [522](#)
  - Pentium, [167](#)
  - Pentium II, [167](#)

- Pentium III, **167–168**
- Pentium 4, **168**
- Pentium 4E, **168**
- PentiumPro, **167, 522**
- Sandy Bridge, **168**
- x86–64. See **x86–64 microprocessors**
- Y86–64. See **Y86–64 instruction set architecture**
- interconnected networks (internets), **921, 921–922**
- interfaces
  - bus, **588**
  - host bus, **597**
- interlocks, load, **441**
- internal exceptions in pipelining, **444**
- internal fragmentation, **846**
- internal read function, **901**
- International Standards Organization (ISO), **4, 35**
- Internet, **921**
  - connections, **929–931**
  - domain names, **927–929**
  - IP addresses, **925–927**
  - organization, **924–925**
  - origins, **931**
- internet addresses, **922**
- Internet Corporation for Assigned Names and Numbers (ICANN), **927**
- Internet domain names, **925**
- *Internet Domain Survey*, **930**
- Internet hosts, number of, **930**

- Internet Protocol (IP), [924](#)
- Internet Software Consortium, [930](#)
- Internet worms, [284](#)
- internets (interconnected networks), [921](#), [921–922](#)
- interpositioning libraries, [707](#), [707–708](#)
  - compile-time, [708–709](#)
  - link-time, [708](#), [710](#)
  - run-time, [710–712](#)
- interpretation of bit patterns, [32](#)
- interprocess communication (IPC), [977](#)
- interrupt handlers, [726](#)
- interruptions, [764](#)
- interrupts, [726](#), [726–727](#)
- interval counting schemes, [564](#)
- `INT N_MAX` [C] maximum value of  $N$ -bit signed data type, [67](#)
- `INT N_MIN` [C] minimum value of  $N$ -bit signed data type, [67](#)
- `int N_t` [C]  $N$ -bit signed integer data type, [67](#)
- `<inttypes.h>` fixed-size integer types, [198](#)
- invalid address status code, [364](#)
- invariants, semaphore, [1002](#)
- I/O (input/output), [9](#), [890](#)
  - memory-mapped, [598](#)
  - ports, [598](#)
  - redirection, [909](#), [909–910](#)
  - system-level. See [system-level I/O](#)
  - Unix, [19](#), [890](#), [890–891](#)
- I/O bridges, [587](#)
- I/O buses, [588](#), [596](#), [598](#)

- I/O devices, **9**
  - addressing, **598**
  - connecting, **596–597**
- I/O multiplexing, **973**
  - concurrent programming with, **978–985**
  - event-driven servers based on, **980–985**
  - pros and cons, **985**
- **IOPB** [Y86–64] instruction code for integer operation instruction, **404**
- IP (Internet Protocol), **924**
- IP address structure, **925, 926**
- IP addresses, **924, 925–927**
- IPC (instructions per cycle), **471**
- IPC (interprocess communication), **977**
- iPhone 5S, **353**
- **IPOPQ** [Y86–64] instruction code for **popq** instruction, **404**
- **IPUSHQ** [Y86–64] instruction code for **pushq** instruction, **404**
- IPv6, **925**
- **IRET** [Y86–64] instruction code for **ret** instruction, **404**
- **IRMMOVQ** [Y86–64] instruction code for **rmmovq** instruction, **404**
- **irmovq** [Y86–64] immediate to register move, **356, 404**
- **IRRMVQ** [Y86–64] instruction code for **rrmovq** instruction, **404**
- ISAs (instruction set architectures), **10, 27, 170, 352**
- ISO (International Standards Organization), **4, 35**
- ISO C11 C standard, **35**
- ISO C90 C standard, **35**
- ISO C99 C standard, **35, 41, 324**

- integral data types, **67**
- static libraries, **684–688**
- `isPtr` function, **869**
- issue time for arithmetic operations, **523**
- issuing instructions, **427–428**
- iterative servers, **946**
- iterative sorting routines, **567**

[OceanofPDF.com](http://OceanofPDF.com)

- `ja` [x86–64] jump if unsigned greater, [206](#)
- `jae` [x86–64] jump if unsigned greater or equal, [206](#)
- Java language, [677](#)
  - byte code, [310](#)
  - linker symbols, [680](#)
  - numeric ranges, [68](#)
  - objects, [266–267](#)
  - software exceptions, [723–724](#), [786](#)
  - threads, [1030](#)
- Java monitors, [1010](#)
- Java Native Interface (JNI), [704](#)
- `jb` [x86–64] jump if unsigned less, [206](#)
- `jbe` [x86–64] jump if unsigned less or equal, [206](#)
- `je` [x86–64] jump when equal, [357](#), [394](#)
- `jb` [x86–64] jump if greater, [206](#), [357](#)
- `jge` [x86–64] jump if greater or equal, [206](#), [357](#)
- `jik` matrix multiplication, [644–646](#), [645](#)
- `jki` matrix multiplication, [644–646](#), [645](#)
- `jl` [x86–64] jump if less, [206](#), [357](#)
- `jle` [x86–64] jump if less or equal, [206](#), [357](#)
- `jmp` [x86–64] jump unconditionally, [206](#), [357](#)
- `jna` [x86–64] jump if not unsigned greater, [206](#)
- `jae` [x86–64] jump if unsigned greater or equal, [206](#)
- `jnb` [x86–64] jump if not unsigned less, [206](#)
- `jnbe` [x86–64] jump if not unsigned less or equal, [206](#)
- `jne` [x86–64] jump if not equal, [206](#), [357](#)

- `jng` [x86–64] jump if not greater, [206](#)
- `jnge` [x86–64] jump if not greater or equal, [206](#)
- JNI (Java Native Interface), [704](#)
- `jnl` [x86–64] jump if not less, [206](#)
- `jnle` [x86–64] jump if not less or equal, [206](#)
- `jns` [x86–64] jump if nonnegative, [206](#)
- `jnz` [x86–64] jump if not zero, [206](#)
- jobs, [760](#)
- joinable threads, [989](#)
- `jp` [x86–64] jump when parity flag set, [306](#)
- `js` [x86–64] jump if negative, [206](#)
- `jtest` script, [465](#)
- jump if greater instruction, [206](#), [357](#)
- jump if greater or equal instruction, [206](#), [357](#)
- jump if less instruction, [206](#), [357](#)
- jump if less or equal instruction, [206](#), [357](#)
- jump if negative instruction, [206](#)
- jump if nonnegative instruction, [206](#)
- jump if not equal instruction, [206](#), [357](#)
- jump if not greater instruction, [206](#)
- jump if not greater or equal instruction, [206](#)
- jump if not less instruction, [206](#)
- jump if not less or equal instruction, [206](#)
- jump if not unsigned greater instruction, [206](#)
- jump if not unsigned less instruction, [206](#)
- jump if not unsigned less or equal instruction, [206](#)
- jump if not zero instruction, [206](#)



- jump if unsigned greater instruction, [206](#)
- jump if unsigned greater or equal instruction, [206](#)
- jump if unsigned less instruction, [206](#)
- jump if unsigned less or equal instruction, [206](#)
- jump if zero instruction, [206](#)
- jump instructions, [10](#), [205–209](#), [404](#)
  - direct, [206](#)
  - indirect, [206](#), [234](#)
  - instruction code for, [404](#)
  - nonlocal, [723](#), [781](#), [781–786](#)
  - targets, [206](#)
- jump tables, [233](#), [234–235](#), [725](#)
- jump-to-middle translation, [223](#)
- jump unconditionally instruction, [206](#), [206](#)
- jump when equal instruction, [357](#)
- jump when parity flag set instruction, [306](#)
- just-in-time compilation, [290](#), [310](#)
- `jz` [x86–64] jump if zero, [206](#)

- $k \times 1$  loop unrolling, [531](#)
- $k \times 1a$  loop unrolling, [544](#)
- $k \times k$  loop unrolling, [539–540](#)
- K&R (C book), [4](#)
- Kahan, William, [109](#)
- Kahn, Robert, [931](#)
- kernel mode
  - exception handlers, [726](#)
  - processes, [734–736](#), [735](#)
  - system calls, [728](#)
- kernels, [17](#), [19](#), [698](#)
  - exception numbers, [725](#)
  - virtual memory, [830–831](#)
- Kernighan, Brian, [2](#), [4](#), [16](#), [35](#), [278](#), [914](#)
- Kerrisk, Michael, [914](#)
- keyboard, signals from, [760–761](#)
- kij matrix multiplication, [644–646](#), [645](#)
- `kill` [Unix] send signal, [761](#)
- `kill` command in GDB debugger, [280](#)
- `kill.c` [CS:APP] `kill` example, [761](#)
- kji matrix multiplication, [644–646](#), [645](#)
- Knuth, Donald, [849](#), [851](#)
- `ksh` [Unix] Unix shell program, [753](#)

- l suffix, [179](#)
- L1 cache, [13](#), [615](#)
- L2 cache, [13](#), [615](#)
- L3 cache, [615](#)
- labels for jump instructions, [205](#)
- LANs (local area networks), [920](#), [920–922](#)
- last-in, first out discipline, [189](#)
- last-in first-out (LIFO) free list order, [863](#)
- latency
  - arithmetic operations, [523](#), [524](#)
  - disks, [594](#)
  - instruction, [413](#)
  - load operations, [554–555](#)
  - pipelining, [412](#)
- latency bounds, [518](#), [524](#)
- lazy binding, [706](#)
- LD Unix static linker, [672](#)
- LD-LINUX.SO linker, [699](#)
- `LD_PRELOAD` environment variable, [710–712](#)
- LDD tool, [713](#)
- `LEA` instruction, [102](#)
- leaf procedures, [241](#)
- leaks, memory, [875](#), [992](#)
- `leaq` [x86–64] load effective address, [191](#), [191–192](#), [277](#)
- least-frequently-used (LFU) replacement policies, [626](#)
- least-recently-used (LRU) replacement policies, [612](#), [626](#)
- least squares fit, [502](#), [504](#)
- `leave` [x86–64] prepare stack for return instruction, [292](#)

- left hoinkies (<), [910](#)
- length of strings, [83](#)
- less than signs <
  - left hoinkies, [909](#)
  - "put to" operator, [890](#)
- levels
  - optimization, [498](#)
  - storage, [609–610](#)
- LF (line feed) characters, [892](#)
- LFU (least-frequently-used) replacement policies, [626](#)
- `libc` library, [911](#)
- `__libc_start_main`, [698](#)
- libraries
  - in concurrent programming, [1024–1025](#)
  - header files, [83](#)
  - interpositioning, [707](#), [707–712](#)
  - shared, [19](#), [699](#), [699–701](#)
  - standard I/O, [911](#)
  - static, [684](#), [684–688](#)
- LIFO (last-in first-out) free list order, [863](#)
- `<limits.h>` file for numeric limit declarations, [67–68](#), [77](#)
- line feed (LF) characters, [892](#)
- line matching
  - direct-mapped caches, [618](#)
  - fully associative caches, [626](#)
  - set associative caches, [625–626](#)
- line replacement
  - direct-mapped caches, [619](#)

- set associative caches, [626](#)
- `.line` section, [675](#)
- linear address spaces, [804](#)
- link-time errors, [7](#)
- link-time interpositioning, [708](#), [710](#)
- linkers and linking, [5](#), [164](#), [170](#)
  - compiler drivers, [671–672](#)
  - dynamic, [699](#), [699–701](#)
  - library interpositioning, [707](#), [707–712](#)
  - object files, [673](#), [673–674](#)
  - executable, [695–698](#)
  - loading, [697–698](#)
  - relocatable, [674–675](#)
  - tools for, [713](#)
  - overview, [670–671](#)
  - position-independent code, [704–707](#)
  - relocation, [689–695](#)
  - shared libraries from applications, [701–703](#)
  - static, [672](#)
  - summary, [713–714](#)
  - symbol resolution, [679–689](#)
  - symbol tables, [675–679](#)
  - virtual memory for, [811–812](#)
- linking phase, [6](#)
- links in directories, [891](#)
- Linux operating system, [20](#), [45](#)
  - code segments, [697–698](#)
  - dynamic linker interfaces, [702](#)

- and ELF, [673](#)
- exceptions, [729–731](#)
- files, [891–893](#)
- signals, [756](#)
- static libraries, [685–686](#)
- virtual memory, [830–833](#)
- Lisp language, [85](#)
- `listen` [Unix] convert active socket to listening socket, [935](#)
- listening descriptors, [936–937](#)
- listening sockets, [935](#)
- little-endian ordering convention, [42](#), [42–44](#)
- load effective address instruction, [191–193](#), [277](#)
- load forwarding in PIPE, [477](#)
- load instructions, [10](#)
- load interlocks, [441](#)
- load operations
  - example, [588](#)
  - process, [519–520](#)
- load penalty in CPI, [467](#)
- load performance of memory, [554–555](#)
- load program function, [750](#)
- load-store architecture in CISC vs. RISC, [362](#)
- load time for code, [670](#)
- load/use data hazards, [439](#), [439–441](#)
- loaders, [672](#), [697](#)
- loading
  - concepts, [699](#)
  - executable object files, [697–698](#)

- process, [697](#)
- programs, [750–752](#)
- shared libraries from applications, [701–703](#)
- virtual memory for, [812](#)
- local area networks (LANs), [920](#), [920–922](#)
- local automatic variables, [994](#)
- local registers, [527](#)
- local static variables, [994](#), [994–995](#)
- local storage
  - registers, [251–253](#)
  - stack, [248–251](#)
- local symbols, [676](#)
- locality, [13](#), [580](#), [604–605](#)
  - blocking for, [647](#)
  - caches, [643–647](#), [810](#)
  - exploiting, [647](#)
  - forms, [604](#), [614](#)
  - instruction fetches, [607–608](#)
  - program data references, [606–607](#)
  - summary, [608–609](#)
- `localtime` function, [1024](#)
- lock-and-copy technique, [1022](#), [1022](#)
- locking mutexes
  - lock ordering rule, [1029](#)
  - for semaphores, [1003](#)
- logic design, [372](#)
  - combinational circuits, [374–380](#), [413](#)
  - logic gates, [373](#), [373](#)

- memory and clocking, [381–384](#)
  - set membership, [380–381](#)
- logic gates, [373](#)
- logic synthesis, [355](#), [373](#), [467](#)
- logical blocks
  - disks, [595](#), [595–596](#)
  - SSDs, [601](#)
- logical control flow, [732](#), [732–733](#)
- logical operations, [56–57](#), [191](#)
  - discussion, [196–197](#)
  - load effective address, [191–193](#)
  - shift, [58](#), [104](#), [192](#), [194–196](#)
  - special, [197–200](#)
  - unary and binary, [194](#)
- `long` [C] integer data type, [40–41](#), [61–62](#)
- `long double` [C] extended-precision floating point, [125](#), [137](#)
- `long double` floating-point declaration, [178](#)
- long words in machine-level data, [179](#)
- `longjmp` [C Stdlib] nonlocal jump, [723](#), [783](#), [783](#)
- loop registers, [527](#)
- loop unrolling, [502](#), [504](#), [531](#)
  - Core i7, [572](#)
  - $k \times 1$ , [531](#)
  - $k \times 1a$ , [544](#)
  - $k \times k$ , [539–540](#)
  - overview, [531–535](#)
  - with reassociation transformations, [541–543](#)
- loopback addresses, [928](#)



- loops, **220**
  - `do-while`, **220–223**
  - `for`, **228–232**
  - inefficiencies, **508–512**
  - reverse engineering, **222**
  - segments, **526–527**
  - for spatial locality, **643–647**
  - `while`, **223–228**
- low-level instructions. See **machine-level programming**
- low-level optimizations, **562**
- lowercase conversions, **509–511**
- LRU (least-recently-used) replacement policies, **612, 626**
- `ls` command, **892**
- `lseek` [Unix] function, **896–897**
- lvalue (C) assignable value for pointers, **277**

- Mac OS X (Apple Macintosh) operating system, [27](#)
- machine checks, [729](#)
- machine code, [164](#)
- machine-level programming
  - arithmetic. See [arithmetic](#)
  - arrays. See [arrays](#)
  - buffer overflow. See [buffer overflow](#)
  - control. See [control structures](#)
  - data-flow graphs from, [525–529](#)
  - data formats, [177–179](#)
- data movement instructions, [182–189](#)
  - encodings, [169–177](#)
  - floating point. See [floating-point code](#)
  - GDB debugger, [279–280](#)
  - heterogeneous data structures. See [heterogeneous data structures](#)
  - historical perspective, [166–169](#)
- information access, [179–180](#)
  - instructions, [4](#)
  - operand specifiers, [180–182](#)
  - overview, [164–166](#)
  - pointer principles, [278](#)
  - procedures. See [procedures](#)
  - x86–64. See [x86–64 microprocessors](#)
- macros for storage allocators, [856–857](#)
- main memory, [9](#)
  - accessing, [587–589](#)
  - memory modules, [584](#)

- main threads, [986](#)
- `malloc` [C Stdlib] allocate heap storage, [35](#), [324](#), [697](#), [839–840](#), [840](#)
  - alignment with, [276](#)
  - declaration, [134–135](#)
  - dynamic memory allocation, [840–843](#)
  - interpositioning libraries, [708](#)
  - wrappers for, [711](#)
- `man ascii` command, [48](#)
- mandatory alignment, [276](#)
- mangling process (C++ and Java), [680](#)
- many-core processors, [471](#)
- map disk object into memory function, [837](#)
- mapping
  - memory. See [memory mapping](#)
  - variables, [994–995](#)
- mark phase in Mark&Sweep, [867](#)
- Mark&Sweep algorithm, [866](#)
- Mark&Sweep garbage collectors, [867](#), [867–870](#)
- masking operations, [55](#)
- matrices
  - adjacency, [660](#)
  - multiplying, [643–647](#)
- maximum floating-point instructions, [302](#)
- maximum two's complement number, [66](#)
- maximum unsigned number function, [63](#)
- maximum values, constants for, [68](#)
- McCarthy, John, [866](#)

- McIlroy, Doug, [16](#)
- media instructions, [294](#)
- `mem_init` [CS:APP] heap model, [855](#)
- `mem_sbrk` [CS:APP] sbrk emulator, [855](#)
- membership, set, [380–381](#)
- `memcpy` [Unix] copy bytes from one region of memory to another, [133](#)
- memory, [580](#)
  - accessing, [587–589](#)
  - aliasing, [499](#), [500](#)
  - associative, [625](#)
  - caches. See [caches and cache memory](#)
  - copying bytes in, [133](#)
  - data alignment in, [273–276](#)
  - data hazards, [435](#)
  - design, [384](#)
  - dynamic. See [dynamic memory allocation](#)
  - hazards, [435](#)
  - hierarchy, [14](#), [14](#), [609–614](#)
  - leaks, [875](#), [992](#)
  - load performance, [554–555](#)
  - in logic design, [361–364](#)
  - machine-language procedures, [239](#)
  - machine-level programming, [170](#)
  - main, [9](#), [584](#), [587–589](#)
  - mapping. See [memory mapping](#)
  - nonvolatile, [587](#)
  - performance, [553–561](#)

- pipelining, [469–470](#)
- protecting, [289](#), [812–813](#)
- RAM. See [random access memory \(RAM\)](#)
- ROM, [587](#)
- threads, [993–994](#)
- trends, [602–604](#)
- virtual. See [virtual memory \(VM\)](#)
- Y86, [356](#)
- memory buses, [587](#)
- memory controllers, [583](#), [584](#)
- memory management units (MMUs), [804](#), [807](#)
- memory-mapped I/O, [598](#)
- memory mapping, [812](#)
  - areas, [833](#), [833](#)
  - `execve` function, [836–837](#)
  - `fork` function, [836](#)
  - in loading, [699](#)
  - objects, [833–836](#)
  - user-level, [837–839](#)
- memory mountains, [639](#)
  - Core i7 microprocessors, [641](#)
  - overview, [639–643](#)
- memory references
  - operands, [181](#)
  - out of bounds. See [buffer overflow](#)
  - in performance, [514–517](#)
- memory stage
  - instruction processing, [385](#), [387–397](#)

- PIPE processor, [454–455](#)
- sequential processing, [400](#)
- sequential Y86–64 implementation, [409–411](#)
- Y86–64 pipelining, [423](#)
- memory system, [580](#)
- memory utilization, [845](#), [845](#)
- `memset` function, declaration, [134–135](#)
- metadata, [903](#), [903–904](#)
- metastable states, [581](#)
- methods
  - hypertext transfer protocol, [951–952](#)
  - objects, [267](#)
- micro-operations, [519](#)
- microarchitecture, [10](#), [517](#)
- microprocessors. See [central processing units \(CPUs\)](#)
- Microsoft Windows operating system, [45](#)
- MIME (multipurpose internet mail extensions) types, [949](#)
- minimum block size, [848](#)
- minimum floating-point instructions, [302](#)
- minimum two's complement number, [66](#)
- minimum values
  - constants, [68](#)
  - two's complement representation, [66](#)
- mispredicted branches
  - handling, [443–444](#)
  - performance penalties, [467](#), [520](#), [549–553](#)
- miss rates, [631](#)
- misses, caches, [470](#), [612](#)

- kinds, [612–613](#)
- penalties, [632](#), [806](#)
- rates, [631](#)
- `mkdir` command, [892](#)
- `mm_coalesce` [CS:APP] allocator: boundary tag coalescing, [860](#)
- `mm_free` [CS:APP] allocator: free heap block, [860](#)
- `mm-ijk` [CS:APP] matrix multiply *ijk*, [645](#)
- `mm-ikj` [CS:APP] matrix multiply *ikj*, [645](#)
- `mm_init` [CS:APP] allocator: initialize heap, [858](#)
- `mm-jik` [CS:APP] matrix multiply *jik*, [645](#)
- `mm-jki` [CS:APP] matrix multiply *jki*, [645](#)
- `mm-kij` [CS:APP] matrix multiply *kij*, [645](#)
- `mm-kji` [CS:APP] matrix multiply *kji*, [645](#)
- `mm_malloc` [CS:APP] allocator: allocate heap block, [860](#), [861](#)
- `mmap` [Unix] map disk object into memory, [837](#), [837–839](#)
- MMUs (memory management units), [804](#), [807](#)
- MMX media instructions, [167](#), [294](#)
- Mockapetris, Paul, [931](#)
- mode bits, [735](#)
- modern processor performance, [518–531](#)
- modes
  - kernel, [726](#), [728](#)
  - processes, [734–736](#), [735](#)
  - user, [726](#), [728](#)
- modified sequential processor implementation, [421–422](#)
- modular arithmetic, [85–86](#), [89](#)
- modules

- DRAM, [584](#), [585](#)
  - object, [673](#)
- monitors, Java, [1010](#)
- monotonicity assumption, [846](#)
- monotonicity property, [124](#)
- Moore, Gordon, [169](#)
- Moore's Law, [169](#), [169](#)
- MOSAIC browser, [949](#)
- motherboards, [9](#)
- Motorola RISC processors, [363](#)
- mov [instruction class] move data, [182](#), [182–183](#)
- `movabsq` [x86–64] move absolute quad word, [183](#), [183](#)
- `movb` [x86–64] move byte, [183](#)
- move absolute quad word instruction, [183](#), [183](#)
- move aligned, packed double precision instruction, [296](#)
- move aligned, packed single precision instruction, [296](#)
- move and sign-extend instruction, [184](#), [185](#)
- move byte instruction, [183](#)
- move data instructions, [182–189](#)
- move double precision instruction, [296](#)
- move double word instruction, [183](#)
- move if even parity instruction, [324](#)
- move if greater instruction, [217](#), [357](#)
- move if greater or equal instruction, [217](#), [357](#)
- move if less instruction, [217](#), [357](#)
- move if less or equal instruction, [217](#), [357](#)
- move if negative instruction, [217](#)
- move if nonnegative instruction, [217](#)



- move if not equal instruction, [217](#), [357](#)
- move if not greater instruction, [217](#)
- move if not greater or equal instruction, [217](#)
- move if not less instruction, [217](#)
- move if not less or equal instruction, [217](#)
- move if not unsigned greater instruction, [217](#)
- move if not unsigned less instruction, [217](#)
- move if not unsigned less or equal instruction, [217](#)
- move if not zero instruction, [217](#)
- move if unsigned greater instruction, [217](#)
- move if unsigned greater or equal instruction, [217](#)
- move if unsigned less instruction, [217](#)
- move if unsigned less or equal instruction, [217](#)
- move if zero instruction, [217](#)
- move instructions, conditional, [214–220](#), [550–553](#)
- move quad word instruction, [183](#)
- move sign-extended byte to double word instruction, [185](#)
- move sign-extended byte to quad word instruction, [185](#)
- move sign-extended byte to word instruction, [185](#)
- move sign-extended double word to quad word instruction, [185](#)
- move sign-extended word to double word instruction, [185](#)
- move sign-extended word to quad word instruction, [185](#)
- move single precision instruction, [296](#)
- move when equal instruction, [357](#)
- move with zero extension instruction, [184](#), [184](#)
- move word instruction, [183](#)
- move zero-extended byte to double word instruction, [184](#)
- move zero-extended byte to quad word instruction, [184](#)

- move zero-extended byte to word instruction, [184](#)
- move zero-extended word to double word instruction, [184](#)
- move zero-extended word to quad word instruction, [184](#)
- movement operations, floating-point code, [296–301](#)
- `movl` [x86–64] move double word, [183](#)
- `movq` [x86–64] move quad word, [183](#)
- `movs` [instruction class] move and sign-extend, [184](#), [185](#)
- `movsbl` [x86–64] move sign-extended byte to double word, [185](#)
- `movsbq` [x86–64] move sign-extended byte to quad word, [185](#)
- `movsbw` [x86–64] move sign-extended byte to word, [185](#)
- `movslq` [x86–64] move sign-extended double word to quad word, [185](#)
- `movswl` [x86–64] move sign-extended word to double word, [185](#)
- `movswq` [x86–64] move sign-extended word to quad word, [185](#)
- `movw` [x86–64] move word, [183](#)
- `movz` [instruction class] move with zero extension, [184](#), [184](#)
- `movzbl` [x86–64] move zero-extended byte to double word, [184](#)
- `movzbq` [x86–64] move zero-extended byte to quad word, [184](#)
- `movzbw` [x86–64] move zero-extended byte to word, [184](#)
- `movzwl` [x86–64] move zero-extended word to double word, [184](#)
- `movzwq` [x86–64] move zero-extended word to quad word, [184](#)
- `rrmovq` instruction, [404](#)
- `mulq` [x86–64] unsigned multiply, [198](#), [198](#)
- multi-core processors, [16](#), [24–25](#), [168](#), [605](#), [972](#)
- multi-level page tables, [819–821](#)
- multi-threading, [17–18](#), [25](#)

- Multics, [16](#)
- multicycle instructions, [468–469](#)
- multidimensional arrays, [258–260](#)
- multiple accumulators in parallelism, [536–541](#)
- multiple zone recording, [592](#)
- multiplexing, I/O, [973](#)
  - concurrent programming with, [978–985](#)
  - event-driven servers based on, [980–985](#)
  - pros and cons, [985](#)
- multiplexors, [374](#), [374–375](#)
  - HCL with case expression, [378](#)
  - word-level, [378–380](#)
- multiplication
  - constants, [101–103](#)
  - floating point, [124](#), [302](#)
  - instructions, [198](#)
  - matrices, [643–647](#)
  - two's complement, [97–101](#)
  - unsigned, [96–97](#), [198](#), [198](#)
- multiply instruction, [192](#)
- multiported random access memory, [382](#)
- multiprocessor systems, [24](#)
- multipurpose internet mail extensions (MIME) types, [949](#)
- multitasking, [733](#)
- multiway branch statements, [232–238](#)
- `munmap` [Unix] unmap disk object, [839](#)
- mutexes
  - lock ordering rule, [1029](#)

- Pthreads, **1010**
- for semaphores, **1003**
- mutual exclusion
  - progress graphs, **1000**
  - semaphores for, **1002–1004**
- mutually exclusive access, **1000**

[OceanofPDF.com](http://OceanofPDF.com)

- `\n` (newline character), [3](#), [891](#)
- *n*-gram statistics, [565](#)
- named pipes, [892](#)
- names
  - domain, [925](#), [927–929](#)
  - mangling and demangling processes (C++ and Java), [680](#), [680](#)
- protocols, [922](#)
- types, [47](#)
- Y86–64 pipelines, [427](#)
- NaN (not a number)
  - constants, [124](#)
  - floating point, [306](#)
  - representation, [114](#), [115](#)
- nanoseconds (ns), [502](#)
- National Science Foundation (NSF), [931](#)
- `need_regids` signal, [405](#)
- `need_val***C` signal, [405](#)
- NEG [instruction class] negate, [192](#)
- negate instruction, [192](#)
- negation, two's complement, [95](#)
- negative overflow, [90](#), [90–91](#)
- nested arrays, [258–260](#)
- nested structures, [268](#)
- network adapters, [597](#)
- network byte order, [925](#)
- network clients, [21](#), [918](#)
- Network File System (NFS), [610](#)

- network programming, **918**
  - client-server model, **918–919**
  - Internet. See **Internet**
  - networks, **919–923**
  - sockets interface. See **sockets interface**
  - summary, **964–965**
  - TINY Web server, **956–964**
  - Web servers, **948–956**
- network servers, **21, 918**
- networks, **20–21**
  - acyclic, **374**
  - LANs, **920, 920–922**
  - WANs, **921, 921–922**
- never taken (NT) branch prediction strategy, **428**
- newline character (`\n`), **3, 891**
- next-fit block placement policy, **849, 849**
- `nexti` command, **280**
- NFS (Network File System), **610**
- NM tool, **713**
- no-execute (NX) memory protection, **289**
- no operation nop instruction, **286, 404**
  - instruction code for, **405**
  - pipelining, **430–431**
  - in stack randomization, **286**
- no-write-allocate approach, **630**
- nodes, root, **866**
- nondeterminism, **748**
- nondeterministic behavior, **748**

- nonexistent variables, referencing, [874](#)
- nonlocal jumps, [723](#), [781](#), [781–786](#)
- nonuniform partitioning, [416–418](#)
- nonvolatile memory, [586](#)
- `nop` [x86–64] no operation instruction, [286](#), [404](#)
  - instruction code for, [405](#)
  - pipelining, [430–431](#)
  - in stack randomization, [286](#)
- `nop sleds`, [286](#)
- `norace.c` [CS:APP] Pthreads program without a race, [1027](#)
- normal operation status code, [364](#), [404](#)
- normalized values, floating-point, [113](#), [113–114](#)
- northbridge chipsets, [588](#)
- not a number (NaN)
  - constants, [124](#)
  - floating point, [306](#)
  - representation, [114](#), [115](#)
  - NOT [instruction class] complement, [192](#)
  - NOT operation
    - Boolean, [51–52](#)
    - C operators, [56–57](#)
    - logic gates, [373](#)
- ns (nanoseconds), [502](#)
- NSF (National Science Foundation), [931](#)
- NSFNET, [931](#)
- NSLOOKUP program, [928](#)
- `ntohl` [Unix] convert network-to-host long, [925](#)
- `ntohs` [Unix] convert network-to-host short, [925](#)

- number systems conversions. See **conversions**
- numeric limit declarations, **77**
- numeric ranges
  - C standards, **61**
  - integral types, **60–62**
  - Java standard, **68**
- NX (no-execute) memory protection, **289**

[OceanofPDF.com](http://OceanofPDF.com)



- `.o` files, [173](#), [672](#)
- `-O1` optimization flag, [170](#)
- `-O2` optimization flag, [170](#)
- OBJDUMP GNU machine-code file reader, [173](#), [279](#), [692](#), [713](#)
- object code, [170](#), [173](#)
- object files, [173](#)
  - executable. See [executable object files](#)
  - formats, [673](#)
  - forms, [673](#)
  - relocatable, [5](#), [672](#), [673–675](#)
  - shared, [673](#)
  - tools, [713](#)
- object modules, [673](#)
- objects
  - C++ and Java, [266](#)
  - memory-mapped, [833–836](#)
  - private, [834](#), [834](#)
  - program, [34](#)
  - shared, [699](#), [833–836](#)
  - as `struct`, [266–267](#)
- oct word, [197](#), [197–198](#)
- `OF` [x86–64] overflow flag condition code, [201](#), [355](#)
- off-by-one errors, [872](#)
- offsets
  - GOTs, [705](#), [705–707](#)
  - memory references, [181](#)
  - PPOs, [814](#)
  - unions, [270](#)

- VPOs, [814](#)
- `-Og` optimization flag, [170](#), [563](#)
- one-operand multiply instructions, [198](#)
- ones'-complement representation, [68](#)
- `open` [Unix] open file, [891](#), [893–895](#)
- `open_clientfd` [CS:APP] establish connection with server, [942](#), [942–944](#)
- `open_listenfd` [CS:APP] establish a listening socket, [944](#), [944](#)
- open operations for files, [891](#), [893–895](#)
- open shared library function, [701](#)
- open-source operating systems, [86–87](#)
- `opendir` functions, [905](#)
- operand specifiers, [180–182](#)
- operate instruction, [10](#)
- operating systems (OS), [15](#)
  - files, [19](#)
  - hardware management, [14–15](#)
  - kernels, [19](#)
  - Linux, [20](#), [45](#)
  - processes, [15–17](#)
  - threads, [17–18](#)
  - Unix, [35](#)
  - virtual memory, [18–19](#)
  - Windows, [45](#)
- operations
  - bit-level, [54–56](#)
  - logical, [56–57](#)
  - shift, [57–59](#)

- optest script, [465](#)
- optimization
  - address translation, [830](#)
  - compiler, [170](#)
  - levels, [498](#)
  - program performance. See [performance](#)
- optimization blockers, [496–497](#), [500](#)
- OPTIONS method, [951](#)
- OR [instruction class] or, [192](#)
- OR operation
  - Boolean, [51–52](#)
  - C operators, [56–57](#)
  - HCL expressions, [374–375](#)
  - logic gates, [373](#)
- order, bytes, [42–49](#)
  - disassembled code, [210](#)
  - network, [925](#)
  - unions, [272](#)
- origin servers, [952](#)
- OS. See [operating systems \(OS\)](#)
- Ossanna, Joe, [16](#)
- out-of-bounds memory references. See [buffer overflow](#)
- out-of-order execution, [518](#)
  - five-stage pipelines, [471](#)
  - history, [522](#)
- overflow
  - arithmetic, [87](#), [87–89](#), [134](#)
  - buffer. See [buffer overflow](#)

- floating-point values, **127**
- identifying, **92–93**
- infinity representation, **115**
- multiplication, **102**
- negative, **90, 90–91**
- operations, **32**
- positive, **90, 90–91**
- overflow flag condition code, **201, 355**
- overloaded functions (C++ and Java), **680**

[OceanofPDF.com](http://OceanofPDF.com)

- P semaphore operation, [1001](#), [1001–1002](#)
- P [CS:APP] wrapper function for Posix sem\_wait, [1002](#)
- P6 microarchitecture, [167](#)
- PA (physical addresses), [803](#)
  - vs. virtual, [803–804](#)
  - Y86–64, [356](#)
- packages, processor, [825](#)
- packet headers, [922](#)
- packets, [922](#)
- padding
  - alignment, [274–275](#)
  - blocks, [847](#)
- page faults
  - DRAM caches, [808](#), [808–809](#)
  - Linux/x86–64 systems, [729](#), [832–833](#)
  - memory caches, [470](#)
  - pipelining caches, [808](#)
- page frames, [805](#)
- page hits in caches, [808](#)
- page table base registers (PTBRs), [814](#)
- page table entries (PTEs), [807](#), [807–808](#)
  - Core i7, [826–828](#)
  - TLBs for, [817–821](#), [823](#)
- page table entry addresses (PTEAs), [817](#)
- page tables, [736](#), [823](#)
  - caches, [806–808](#), [807](#)
  - multi-level, [819–821](#)
- paged-in pages, [809](#)

- paged-out pages, [809](#)
- pages
  - allocation, [810](#)
  - demand zero, [833](#)
  - dirty, [827](#)
  - physical, [805](#), [805–806](#)
  - SSDs, [601](#)
  - virtual, [289](#), [805](#), [805–806](#)
- paging
  - demand, [810](#)
  - description, [809](#)
- parallel execution, [734](#)
- parallel flows, [734](#), [734](#)
- parallel programs, [1013](#)
- parallelism, [24](#), [536](#)
  - instruction-level, [26](#), [497](#), [518](#), [562](#)
  - multiple accumulators, [536–541](#)
  - reassociation transformations, [541–546](#)
  - SIMD, [26](#), [546–547](#)
  - thread-level, [26](#)
  - threads for, [1013–1018](#)
- parent directories, [892](#)
- parent processes, [739](#), [739–740](#)
- parity flag condition code, [178](#), [306](#)
- `parse_uri` [CS:APP] TINY helper function, [960](#)
- `parse_line` [CS:APP] shell helper routine, [756](#)
- partitioning
  - addresses, [615–616](#)

- nonuniform in pipelining, **416–418**
- passing data
  - machine-language procedures, **239**
  - pointers to structures, **266**
- pathnames, **893**
- Patterson, David, **361, 471**
- `pause` [Unix] suspend until signal arrives, **750**
- payloads
  - aggregate, **845**
  - Ethernet, **920**
  - protocol, **922**
- PC. See **program counters (PCs)**
- PC-relative addressing
  - jumps, **207, 207–209**
  - symbol references, **690, 692–693**
  - Y86–64, **359**
- PC selection stage in PIPE processor, **447–449**
- PC update stage
  - instruction processing, **385, 387–395**
  - sequential processing, **400**
  - sequential Y86–64 implementation, **411**
- PCI (peripheral component interconnect), **598**
- PCIe (PCI express), **598**
- PE (Portable Executable) format, **673**
- peak utilization metric, **844–845, 845**
- peer threads, **986**
- pending bit vectors, **759**
- pending signals, **758**

- Pentium II microprocessor, [167](#)
- Pentium III microprocessor, [167–168](#)
- Pentium 4 microprocessor, [168](#)
- Pentium 4E microprocessor, [168](#)
- Pentium microprocessor, [167](#)
- PentiumPro microprocessor, [167](#), [522](#)
- performance, [6](#)
  - Amdahl's law, [22–24](#)
  - basic strategies, [561–562](#)
  - bottlenecks, [562–568](#)
  - branch prediction and misprediction penalties, [549–553](#)
  - caches, [553](#), [631–633](#), [639–647](#)
  - compiler capabilities and limitations, [498–502](#)
  - expressing, [502–504](#)
  - limiting factors, [548–553](#)
  - loop inefficiencies, [508–512](#)
  - loop unrolling, [531](#), [531–535](#)
  - memory, [553–561](#)
  - memory references, [514–517](#)
  - modern processors, [518–531](#)
  - overview, [496–498](#)
  - parallelism. See [parallelism](#)
  - procedure calls, [512–513](#)
  - program example, [504–508](#)
  - program profiling, [562–564](#)
  - register spilling, [548–549](#)
  - results summary, [547–548](#)
  - sequential Y86–64 implementation, [412](#)



- summary, **568–569**
- Y86–64 pipelining, **464–468**
- periods (.) in dotted-decimal notation, **926**
- persistent connections in HTTP, **952**
- P<sub>F</sub> [x86–64] parity flag condition code, **178, 306**
- physical address spaces, **804**
- physical addresses (PA), **803**
  - vs. virtual, **803–804**
  - Y86–64, **356**
- physical page numbers (PPNs), **814**
- physical page offset (PPO), **814**
- physical pages (PPs), **805, 805–806**
- pi in floating-point representation, **140**
- PIC (position-independent code), **704**
  - data references, **704–705**
  - function calls, **705–707**
- picoseconds (ps), **413, 502**
- PIDs (process IDs), **739**
- pins, DRAM, **582–583**
- PIPE– processor, **421, 422, 426–430**
- PIPE processor stages, **439–440, 447**
  - decode and write-back, **449–453**
  - execute, **453–454**
  - memory, **454–455**
  - PC selection and fetch, **447–449**
- pipelining, **26, 215, 412**
  - bubble, **434**
  - combinational, **412–414**

- deep, [418–419](#)
- diagram, [413](#)
- five-stage, [471](#)
- functional units, [523–524](#)
- instruction, [549](#)
- limitations, [416–418](#)
- nonuniform partitioning, [416–418](#)
- operation, [414–416](#)
- registers, [413](#), [427](#)
- store operation, [555–556](#)
- systems with feedback, [419–421](#)
- Y86–64. See [Y86–64 pipelined implementations](#)
- pipes, [977](#)
- Pisano, Leonardo (Fibonacci), [32](#)
- placement
  - memory blocks, [847](#), [849](#)
  - policies, [612](#), [849](#)
- platters, disk, [590](#), [591](#)
- PLT (procedure linkage table), [706](#), [706–707](#)
- PMAP tool, [786](#)
- point-to-point connections, [929](#)
- pointers, [34](#)
  - arithmetic, [257–258](#), [873](#)
  - arrays relationship to, [48](#), [277](#)
  - block, [856](#)
  - creating, [48](#), [188](#)
  - declaring, [41](#)
  - dereferencing, [48](#), [188](#), [257](#), [277](#), [870–871](#)

- examples, **188**
  - to functions, **278**
  - machine-level data, **177**
  - principles, **278**
  - role, **36**
  - stack, **239**
  - to structures, **266**
  - virtual memory, **870–873**
  - `void*`, **48**
- polynomial evaluation, **530, 530, 572–573**
  - pools of peer threads, **987**
  - pop instructions in x86–64 models, **372**

[OceanofPDF.com](http://OceanofPDF.com)

- pop operations on stack, [189](#), [189–191](#)
- `popq` [Y86–64] pop instruction, [190](#), [190](#), [357](#)
  - behavior of, [371](#)
  - code for, [404](#)
  - run-time stack, [239](#)
- portability and data type size, [41](#)
- Portable Executable (PE) format, [673](#)
- portable signal handling, [774–775](#)
- ports
  - Ethernet, [920](#)
  - Internet, [930](#)
  - I/O, [598](#)
  - register files, [382](#)
  - `.pos` [Y86–64] directive, [366](#)
- position-independent code (PIC), [704](#)
  - data references, [704–705](#)
  - function calls, [705–707](#)
- positive overflow, [90](#), [90–91](#)
- `posix_error` [CS:APP] reports Posix-style errors, [1043](#)
- Posix standards, [16](#)
- Posix-style error handling, [1042](#), [1043](#)
- Posix threads, [987](#), [987–988](#)
- POST method, [951–953](#)
- PowerPC
  - processor family, [352](#), [361](#)
  - RISC design, [361–363](#)
- powers of 2, division by, [103–107](#)
- PPNs (physical page numbers), [814](#)

- PPO (physical page offset), [814](#)
- PPs (physical pages), [805](#), [805–806](#)
- precedence of shift operations, [59](#)
- precision, floating-point, [113](#), [137](#)
- prediction
  - branch, [215](#)
  - misprediction penalties, [549–553](#)
  - Y86–64 pipelining, [422](#), [427–429](#)
- preempted processes, [733](#)
- prefetching mechanism, [641–642](#)
- prefix sums, [502](#), [503](#), [561](#), [573](#)
- prepare stack for return instruction, [292](#)
- preprocessors, [5](#), [170](#)
- prethreading, [1005–1013](#), [1008](#)
- primary inputs in logic gates, [374](#)
- principle of locality, [604](#), [604](#)
- `print` command, [280](#)
- `print_getaddrinfo` error message function, [938](#)
- `printf` [C Stdlib] formatted printing function
  - formatted printing, [47](#)
  - numeric values with, [75](#)
- printing, formatted, [47](#)
- priorities
  - PIPE processor forwarding sources, [451–452](#)
  - write ports, [408](#)
- private address space, [734](#)
- private areas, [834](#)
- private copy-on-write structures, [836](#)

- private declarations (C++ and Java), [677](#)
- private objects, [834](#), [834](#)
- privileged instructions, [735](#)
- `/proc` filesystem, [735](#), [735–736](#), [786](#)
- procedure linkage table (PLT), [706](#), [706–707](#)
- procedure return instruction, [357](#)
- procedures, [238–239](#)
  - call performance, [512–513](#)
  - control transfer, [241–245](#)
  - data transfer, [245–248](#)
  - floating-point code in, [301–302](#)
  - recursive, [253–255](#)
  - register usage conventions, [251–253](#)
  - run-time stack, [239–241](#)
- process contexts, [16](#), [736](#)
- process graphs, [741](#), [742](#)
- process groups, [759](#)
- process IDs, [739](#)
- process tables, [736](#)
- processes, [15](#), [732](#), [738](#)
  - background, [753](#)
  - child, [740](#)
  - concurrent flow, [732–734](#), [733](#)
  - concurrent programming with, [973–977](#)
  - concurrent servers based on, [974–975](#)
  - context switches, [736–737](#)
  - creating and terminating, [739–743](#)
  - default behavior, [744](#)

- error conditions, [745–746](#)
- exit status, [745](#)
- foreground, [753](#)
- group, [759](#)
- IDs, [739–740](#)
- loading programs, [699](#), [750–752](#)
- overview, [15–17](#)
- parent, [739](#), [740](#)
- preempted, [733](#)
- private address space, [734](#)
- vs. programs, [753](#)
- pros and cons, [975](#)
- reaping, [743](#), [743–749](#)
- running programs, [750–756](#)
- sleeping, [749–750](#)
- tools, [786–787](#)
- user and kernel modes, [734–735](#)
- `waitpid` function, [746–749](#)
- zombie, [743](#)
- processor-memory gap, [13](#), [604](#)
- processor packages, [825](#)
- processor states, [723](#)
- processors. See [central processing units \(CPUs\)](#)
- producer-consumer problem, [1004](#), [1005–1006](#)
- profilers code, [497](#)
- profiling, program, [562–564](#)
- program counters (PCs), [9](#), [44](#)
  - in fetch stage, [384](#)

- hazards, [435](#)
- machine-language procedures, [239](#)
- `%rip`, [171](#)
- SEQ timing, [401](#)
- Y86–64 instruction set architecture, [356](#)
- Y86–64 pipelining, [423](#), [427–429](#)
- program data references locality, [606–607](#)
- program header tables, [696](#), [696](#)
- program registers
  - clocked, [381–384](#)
  - data hazards, [435](#)
  - Y86–64, [355–356](#)
- programmable ROMs (PROMs), [587](#)
- programmer-visible state, [355](#), [355–356](#)
- programs
  - code and data, [18](#)
  - concurrent. See [concurrent programming](#)
  - forms, [4–5](#)
  - loading and running, [750–752](#)
  - machine-level. See [machine-level programming](#)
  - objects, [34](#)
  - vs. processes, [753](#)
  - profiling, [562–564](#)
  - running, [10–12](#), [753–756](#)
  - Y86–64, [364–370](#)
- progress graphs, [999](#), [999–1001](#)
  - deadlock regions, [1027–1028](#), [1028](#)
  - forbidden regions, [1003](#)



- limitations, [1004](#)
- prologue blocks, [855](#)
- PROMs (programmable ROMs), [587](#)
  - protection, memory, [812–813](#)
  - protocol software, [922](#)
  - protocols, [922](#)
  - proxy caches, [952](#)
  - proxy chains, [952](#)
  - ps (picoseconds), [413](#), [502](#)
  - PS tool, [786](#)
- pseudorandom number generator functions, [1021](#)
- `psum-array.c` [CS:APP] parallel sum program using array, [1016](#)
- `psum-local.c` [CS:APP] parallel sum program using local variables, [1017](#)
- `psum-mutex.c` [CS:APP] parallel sum program using mutex, [1015](#)
- PTBRs (page table base registers), [814](#)
- PTEAs (page table entry addresses), [817](#)
- PTEs (page table entries), [807](#), [807–808](#)
  - Core i7, [826–828](#)
  - TLBs for, [817–821](#), [823](#)
  - `pthread_cancel` [Unix] terminate another thread, [989](#)
  - `pthread_create` [Unix] create a thread, [988](#)
  - `pthread_detach` [Unix] detach thread, [990](#), [990](#)
  - `pthread_exit` [Unix] terminate current thread, [989](#)
  - `pthread_join` [Unix] reap a thread, [989](#)
  - `pthread_once` [Unix] initialize a thread, [990](#), [1012](#)
  - `pthread_self` [Unix] get thread ID, [988](#)

- Pthreads, [987](#), [987–988](#), [1010](#)
- public declarations (C++ and Java), [677](#)
- push instructions in x86–64 models, [372](#)
- push operations on stack, [189](#), [189–191](#)
- `pushq` [x86–64] push quad word, [173](#), [190](#), [190](#), [357](#)
  - code for, [404](#)
  - processing steps, [370–371](#), [392](#)
  - run-time stack, [239](#)
- PUT method in HTTP, [951](#)
- "put to" operator (C++), [890](#)
- `qsort` function, [566](#)
- quad words, [177](#)
- QuickPath interconnect, [588](#), [826](#)
- `quit` command, [280](#)

- `R_X86_64_32` (absolute addressing), [691](#)
- `R_X86_64_PC32` (PC-relative addressing), [690](#)
  - symbol table entry, [677](#)
  - and Unix, [673](#)
  - `%r8` [Y86–64] program register, [180](#), [355](#)
  - `%r8d` [x86–64] low order 32 bits of register `%r8`, [180](#)
  - `%r8w` [x86–64] low order 16 bits of register `%r8`, [180](#)
  - `%r9` [Y86–64] program register, [180](#), [355](#)
  - `%r9d` [x86–64] low order 32 bits of register `%r9`, [180](#)
  - `%r9w` [x86–64] low order 16 bits of register `%r9`, [180](#)
  - `%r10` [Y86–64] program register, [180](#), [355](#)
  - `%r10d` [x86–64] low order 32 bits of register `%r10`, [180](#)
  - `%r10w` [x86–64] low order 16 bits of register `%r10`, [180](#)
  - `%r11` [Y86–64] program register, [180](#), [355](#)
  - `%r11d` [x86–64] low order 32 bits of register `%r11`, [180](#)
  - `%r11w` [x86–64] low order 16 bits of register `%r11`, [180](#)
  - `%r12` [Y86–64] program register, [180](#), [355](#)
  - `%r12d` [x86–64] low order 32 bits of register `%r12`, [180](#)
  - `%r12w` [x86–64] low order 16 bits of register `%r12`, [180](#)
  - `%r13` [Y86–64] program register, [180](#), [355](#)
  - `%r13d` [x86–64] low order 32 bits of register `%r13`, [180](#)
  - `%r13w` [x86–64] low order 16 bits of register `%r13`, [180](#)
  - `%r14` [Y86–64] program register, [180](#), [355](#)
  - `%r14d` [x86–64] low order 32 bits of register `%r14`, [180](#)
  - `%r14w` [x86–64] low order 16 bits of register `%r14`, [180](#)

- `%r15` [x86–64] program register, **180**, **355**
- `%r15d` [x86–64] low order 32 bits of register `%r15`, **180**
- `%r15w` [x86–64] low order 16 bits of register `%r15`, **180**
- `race.c` [CS:APP] program with a race, **1025**
- race conditions, **776**, **992**
  - concurrent programming, **1025**, **1025–1027**
  - signals, **776–778**
- RAM. See **random access memory (RAM)**
- `rand` [CS:APP] pseudorandom number generator, **1021**, **1024**
- `rand_r` function, **1024**
- random access memory (RAM), **381**, **581**
  - dynamic. See **dynamic RAM (DRAM)**
  - multiported, **382**
  - processors, **384**
  - SEQ timing, **401**
  - static. See **static RAM (SRAM)**
- random operations in SSDs, **600**
- random replacement policies, **612**
- ranges
  - asymmetric, **66**, **77**
  - bytes, **36**
  - constants for, **67–68**
  - data types, **40**
  - integral types, **60–62**
  - Java standard, **68**
- RAS (row access strobe) requests, **583**
- `%rax` [Y86–64] program register, **180**, **355**

- `%rbp` [Y86–64] program register, [180](#), [355](#)
- `%rbx` [Y86–64] program register, [180](#), [355](#)
- `%rcx` [Y86–64] program register, [180](#), [355](#)
- `%rdi` [Y86–64] program register, [180](#), [355](#)
- `%rdx` [Y86–64] program register, [180](#), [355](#)
- reachability graphs, [866](#)
- reachable nodes, [866](#)
- read access, [289](#)
- read and echo input lines function, [947](#)
- read bandwidth, [639](#)
- read environment variable function, [751](#)
- read/evaluate steps, [753](#)
- `read` [Unix] read file, [895](#), [895–897](#)
- read-only memory (ROM), [586](#)
- read-only register, [527](#)
- read operations
  - buffered, [898](#), [900–901](#)
  - disk sectors, [597–599](#)
  - file metadata, [903–904](#)
  - files, [891](#), [895–897](#)
  - SSDs, [601](#)
  - unbuffered, [897–898](#)
  - uninitialized memory, [871](#)
- read ports, [382](#)
- `read_requesthdrs` [CS:APP] TINY helper function, [960](#)
- read sets, [978](#)
- read throughput, [639](#)

- read transactions
  - descriptions, [587](#)
  - example of, [588–589](#)
- read/write heads, [592](#)
- `readdir` functions, [905](#)
- READELF GNU object file reader, [678](#), [713](#)
- readers-writers problem, [1006](#), [1008](#)
- reading
  - directory contents, [905–906](#)
  - disk sectors, [597](#)
  - `readline` function, [903](#)
  - `readn` function, [903](#)
- ready read descriptors, [978](#)
- ready sets, [978](#)
- `realloc` function, [841](#)
- reap thread function, [989](#)
- reaping
  - child processes, [743](#), [743–749](#)
  - threads, [989](#)
- rearranging signals in pipelining, [426–427](#)
- reassociation transformations, [541](#), [541–546](#), [570](#)
- receiving signals, [758](#), [762–764](#)
- recording density, [591](#)
- recording zones, [592](#)
- recursive procedures, [253–255](#)
- redirection of I/O, [909](#), [909–910](#)
- reduced instruction set computers (RISC), [361](#)
  - vs. CISC, [361–363](#)

- SPARC processors, [471](#)
- reentrancy issues, [1023–1024](#)
- reentrant functions, [766](#), [1023](#)
- reference bits, [827](#)
- reference counts, [906](#)
- reference machines, [507](#)
- referencing
  - data in free heap blocks, [874–875](#)
  - nonexistent variables, [874](#)
- refresh, DRAM, [582](#)
- regions, deadlock, [1027–1028](#), [1028](#)
- register files, [10](#), [358](#)
  - contents, [382–383](#), [521](#)
  - purpose, [358–359](#)
  - SEQ timing, [401](#)
- register identifier (ID), [358–359](#)
- register operands, [181](#)
- register specifier bytes in Y86–64 instruction, [358](#)
- register to memory move instruction, [356](#)
- register to register move instruction, [356](#)
- registers, [9](#)
  - clocked, [381](#)
  - data hazards, [435](#)
  - data transfer, [245–248](#)
  - hardware, [381–384](#)
  - local, [527](#)
  - local storage, [251–253](#)
  - loop, [527](#)

- pipeline, [413](#), [427](#)
- program, [355–356](#), [381–384](#), [435](#)
- read-only, [527](#)
- register files, [171](#)
- renaming, [522](#)
- spilling, [548–549](#)
- updating conventions, [179](#)
- write-only, [527](#)
- x86–64 integer, [179](#), [179–180](#)
- Y86–64, [359](#), [422–426](#)
- regular files, [833](#), [891](#)
- `.rel.data` section, [675](#)
- `.rel.text` section, [675](#)
- relabeling signals, [426–427](#)
- relative pathnames, [893](#)
- relative speedup in parallel programs, [1019](#)
- reliable connections, [930](#)
- relocatable object files, [5](#), [672](#), [673–675](#)
- relocation, [673](#), [689–690](#)
  - algorithm, [691](#)
  - entries, [690](#), [690–691](#)
  - PC-relative references, [692–693](#)
  - practice problems, [694–695](#)
- remove item from bounded buffer function, [1007](#)
- renaming registers, [522](#)
- `rep` [x86–64] string repeat instruction used as no-op, [208](#)
- replacement policies, [613](#)
- replacing blocks, [612](#)



- report shared library error function, [702](#)
- reporting errors, [1043](#)
- request headers in HTTP, [951](#)
- request lines in HTTP, [951](#)
- requests
  - client-server model, [918](#)
  - HTTP, [951](#), [951–952](#)
- requests for comments (RFCs), [965](#)
- reset configuration in pipelining, [460](#)
- resident sets, [810](#)
- resources
  - client-server model, [918](#)
  - shared, [1004–1008](#)
- `RESP` [Y86–64] register ID for `%rsp`, [404](#)
- response bodies in HTTP, [952](#)
- response headers in HTTP, [952](#)
- response lines in HTTP, [952](#)
- responses
  - client-server model, [918](#)
  - HTTP, [952](#), [952–953](#)
- `restart.c` [CS:APP] nonlocal jump example, [785](#)
- restrictions, alignment, [273–276](#)
- `ret` [Y86–64] procedure return, [357](#)
- `ret` [x86–64] return from procedure call, [208](#), [241–242](#)
- `ret` instruction, [404](#)
  - processing steps, [395](#)
  - Y86–64 pipelining, [428–429](#), [455–457](#), [461–462](#)
- retiming circuits, [421](#)

- retirement units, [521](#)
- `retq` [x86–64] return from procedure, [241](#)
- return addresses, [241](#)
  - predicting, [429](#)
  - procedures, [240](#)
- return penalty in CPI, [467](#)
- reverse engineering
  - loops, [222](#)
  - machine code, [165](#)
- revolutions per minute (RPM), [590](#)
- RFCs (requests for comments), [965](#)
- ridges in memory mountains, [641](#)
- right hoinkies (>), [910](#)
- right shift operations, [57–58](#), [192](#)
- rings, Boolean, [52](#)
- RIO [CS:APP] Robust I/O package, [897](#)
  - buffered functions, [898–902](#)
  - origins, [903](#)
  - unbuffered functions, [897–898](#)
- `rio_read` [CS:APP] internal read function, [901](#)
- `rio_readinitb` [CS:APP] init read buffer, [898](#), [900](#)
- `rio_readlineb` [CS:APP] robust buffered read, [898](#), [902](#)
- `rio_readn` [CS:APP] robust unbuffered read, [897](#), [897–899](#), [901](#), [903](#)
- `rio_readnb` [CS:APP] robust buffered read, [898](#), [902](#)
- `rio_t` [CS:APP] read buffer, [900](#)
- `rio_writen` [CS:APP] robust unbuffered write, [897](#), [897–899](#), [903](#)

- `rip` [x86–64] program counter, [171](#)
- `%rip` program counter, [171](#)
- RISC (reduced instruction set computers), [361](#)
  - vs. CISC, [361–363](#)
  - SPARC processors, [471](#)
- Ritchie, Dennis, [2](#), [4](#), [16](#), [35](#), [914](#)
- `rmdir` command, [892](#)
- `rmmovq` [Y86–64] register to memory move, [356](#), [390](#), [404](#)
- `RNONE` [Y86–64] ID for indicating no register, [404](#)
- Roberts, Lawrence, [931](#)
- robust buffered read functions, [898](#), [902](#)
- Robust I/O (`RIO`) package, [897](#)
  - buffered functions, [898–902](#)
  - origins, [903](#)
  - unbuffered functions, [897–898](#)
- robust unbuffered read function, [897](#), [897–899](#)
- robust unbuffered write function, [897](#), [897–899](#)
- `.rodata` section, [674](#)
- ROM (read-only memory), [586](#)
- root directory, [892](#)
- root nodes, [866](#)
- rotating disks term, [591](#)
- rotational latency of disks, [594](#)
- rotational rate of disks, [590](#)
- round-down mode, [121](#), [121](#)
- round-to-even mode, [120](#), [120–121](#), [124](#)
- round-to-nearest mode, [120](#), [120](#)
- round-toward-zero mode, [120](#), [120–121](#)

- round-up mode, [121](#), [121](#)
- rounding
  - in division, [105–106](#)
  - floating-point representation, [120–122](#)
- rounding modes, [120](#), [120–122](#)
- routers, Ethernet, [921](#)
- routines, thread, [987](#)
- row access strobe (RAS) requests, [583](#)
- row-major array order, [258](#), [606](#)
- row-major sum function, [635](#), [635](#)
- RPM (revolutions per minute), [590](#)
- `rrmovq` [Y86–64] register to register move, [356](#), [404](#)
- `%rsi` [x86–64] program register, [180](#)
- `%rsp` [Y86–64] stack pointer program register [179–180](#), [355](#)
- `run` command, [280](#)
- run concurrency, [733](#)
- run time
  - interpositioning, [710–712](#)
  - linking, [670](#)
  - shared libraries, [699](#)
  - stacks, [171](#), [239–241](#)
- running
  - in parallel, [734](#)
  - processes, [739](#)
  - programs, [10–12](#), [750–756](#)

- `.s` assembly language files, [672](#)
- `SA` [CS:APP] shorthand for `struct` `sockaddr`, [933](#)
- `SADR` [Y86–64] status code for address exception, [404](#)
- safe optimization, [498](#), [498–499](#)
- safe signal handling, [766–770](#)
- safe trajectories in progress graphs, [1000](#)
- safely emit error message and terminate instruction, [766](#), [768](#)
- safely emit long int instruction, [766](#), [768](#)
- safely emit string instruction, [766](#), [768](#)
- `SAL` [instruction class] shift left, [192](#)
- `salb` [x86–64] shift left, [195](#)
- `salq` [x86–64] shift left, [195](#)
- `salw` [x86–64] shift left, [195](#)
- Sandy Bridge microprocessor, [168](#)
- `SAOK` [Y86–64] status code for normal operation, [404](#)
- `SAR` [instruction class] shift arithmetic right, [192](#), [195](#)
- SATA interfaces, [597](#)
- saturating arithmetic, [134](#)
- `sbrk` [C Stdlib] extend the heap, [841](#), [841](#)
  - emulator, [855](#)
  - heap memory, [850](#)
- `sbuf` [CS:APP] shared bounded buffer package, [1005](#), [1006](#)
- `sbuf_deinit` [CS:APP] free bounded buffer, [1007](#)
- `sbuf_init` [CS:APP] allocate and init bounded buffer, [1007](#)
- `sbuf_insert` [CS:APP] insert item in a bounded buffer, [1007](#)
- `sbuf_remove` [CS:APP] remove item from bounded buffer, [1007](#)

- `sbuf_t` [CS:APP] bounded buffer used by SBUF package, [1006](#)
- scalar code performance summary, [547–548](#)
- scalar format data, [294](#)
- scalar instructions, [296](#)
- scale factor in memory references, [181](#)
- scaling parallel programs, [1019](#), [1019–1020](#)
- `scanf` function, [870–871](#)
- schedule alarm to self function, [762](#)
- schedulers, [736](#)
- scheduling, [736](#)
  - events, [763](#)
  - shared resources, [1004–1008](#)
- SCSI interfaces, [597](#)
- SDRAM (synchronous DRAM), [586](#)
- second-level domain names, [928](#)
- second readers-writers problem, [1008](#)
- sectors, disk, [590](#), [590–592](#)
  - access time, [593–595](#)
  - gaps, [596](#)
  - reading, [597–599](#)
- security monoculture, [285](#)
- security vulnerabilities, [7](#)
  - `getpeername` function, [86–87](#)
  - XDR library, [100](#)
- seeds for pseudorandom number generators, [1021](#)
- seek operations, [593](#), [891](#)
- seek time for disks, [593](#), [593](#)
- segmentation faults, [729](#)

- segmented addressing, [287–288](#)
- segments
  - code, [696](#), [697–698](#)
  - data, [696](#)
  - Ethernet, [920](#), [920](#)
  - loops, [526–527](#)
  - virtual memory, [830](#)
- segregated fits, [863](#), [864–865](#)
- segregated free lists, [863–865](#)
- segregated storage, [863](#)
- `select` [Unix] wait for I/O events, [977](#)
- self-loops, [980](#)
- self-modifying code, [435](#)
- `sem_init` [Unix] initialize semaphore, [1002](#)
- `sem_post` [Unix] V operation, [1002](#)
- `sem_wait` [Unix] P operation, [1002](#)
- semaphores, [1001](#), [1001–1002](#)
  - concurrent server example, [1005–1013](#)
  - for mutual exclusion, [1002–1004](#)
  - for scheduling shared resources, [1004–1008](#)
- sending signals, [735](#), [759–762](#)
- separate compilation, [670](#)
- SEQ+ pipelined implementations, [421](#), [421–422](#)
- SEQ Y86–64 processor design.
- See [sequential Y86–64 implementation](#)
- sequential circuits, [381](#)
- sequential execution, [200–201](#)
- sequential operations in SSDs, [600](#)

- sequential reference patterns, [606](#)
- sequential Y86–64 implementation, [384](#), [421](#)
  - decode and write-back stage, [406–408](#)
  - execute stage, [408–409](#)
  - fetch stage, [404–406](#)
  - hardware structure, [396–400](#)
  - instruction processing stages, [384–395](#)
  - memory stage, [409–411](#)
  - PC update stage, [411](#)
  - performance, [412](#)
  - SEQ+ implementations, [421](#), [421–422](#)
  - timing, [400–403](#)
- `serve_dynamic` [CS:APP] TINY helper function, [963–964](#)
- `serve_static` [CS:APP] TINY helper function, [961–963](#)
- servers, [21](#)
  - client-server model, [918](#)
  - concurrent. See [concurrent servers](#)
  - network, [21](#)
  - Web. See [Web servers](#)
- service conversions in sockets interface, [937–942](#)
- services in client-server model, [918](#)
- serving
  - dynamic content, [953–954](#)
  - Web content, [949](#)
- set associative caches, [624](#)
  - line matching and word selection, [625–626](#)
  - line replacement, [625](#)
  - set selection, [625](#), [625](#)



- set bit in descriptor set macro, **978**
- set index bits, **615**, **615–616**
- set on equal instruction, **203**
- set on greater instruction, **203**
- set on greater or equal instruction, **203**
- set on less instruction, **203**
- set on less or equal instruction, **203**
- set on negative instruction, **203**
- set on nonnegative instruction, **203**
- set on not equal instruction, **203**
- set on not greater instruction, **203**
- set on not greater or equal instruction, **203**
- set on not less instruction, **203**
- set on not less or equal instruction, **203**
- set on not zero instruction, **203**
- set on unsigned greater instruction, **203**
- set on unsigned greater or equal instruction, **203**
- set on unsigned less instruction, **203**
- set on unsigned less or equal instruction, **203**
- set on unsigned not greater instruction, **203**
- set on unsigned not less instruction, **203**
- set on unsigned not less or equal instruction, **203**
- set on zero instruction, **203**
- set process group ID function, **759**
- set selection
  - direct-mapped caches, **618**
  - fully associative caches, **625**
  - set associative caches, **625**

- `seta` [x86–64] set on unsigned greater, **203**
- `setae` [x86–64] set on unsigned greater or equal, **203**
- `setb` [x86–64] set on unsigned less, **203**
- `setbe` [x86–64] set on unsigned less or equal, **203**
- `sete` [x86–64] set on equal, **203**
- `setenv` [Unix] create/change environment variable, **752**
- `setg` [x86–64] set on greater, **203**
- `setge` [x86–64] set on greater or equal, **203**
- `setjmp` [C Stdlib] init nonlocal jump, **723**, **781**, **783**
- `setjmp.c` [CS:APP] nonlocal jump example, **784**
- `setl` [x86–64] set on less, **203**
- `setle` [x86–64] set on less or equal, **203**
- `setna` [x86–64] set on unsigned not greater, **203**
- `setnae` [x86–64] set on unsigned not less or equal, **203**
- `setnb` [x86–64] set on unsigned not less, **203**
- `setnbe` [x86–64] set on unsigned not less or equal, **203**
- `setne` [x86–64] set on not equal, **203**
- `setng` [x86–64] set on not greater, **203**
- `setnge` [x86–64] set on not greater or equal, **203**
- `setnl` [x86–64] set on not less, **203**
- `setnle` [x86–64] set on not less or equal, **203**
- `setns` [x86–64] set on nonnegative, **203**
- `setnz` [x86–64] set on not zero, **203**
- `setpgid` [Unix] set process group ID, **759**
- `sets`

- vs. cache lines, [634](#)
  - membership, [380–381](#)
- [sets](#) [x86–64] set on negative, [203](#)
- [setz](#) [x86–64] set on zero, [203](#)
- [SF](#) [x86–64] sign flag condition code, [201](#), [355](#)
- [sh](#) [Unix] Unix shell program, [753](#)
- Shannon, Claude, [51](#)
- shared areas, [834](#)
- shared libraries, [19](#), [699](#)
  - dynamic linking with, [699–701](#)
  - loading and linking from applications, [701–703](#)
- shared object files, [673](#)
- shared objects, [699](#), [833–836](#), [834](#)
- shared resources, scheduling, [1004–1008](#)
- shared variables, [992–995](#), [993](#)
- sharing
  - files, [906–908](#)
  - virtual memory for, [812](#)
- [sharing.c](#) [CS:APP] sharing in Pthreads programs, [993](#)
- [shelllex.c](#) [CS:APP] shell main routine, [754](#)
- shells, [7](#), [753](#)
- shift arithmetic right instruction, [192](#)
- shift left instruction, [192](#)
- shift logical right instruction, [192](#)
- shift operations, [57](#), [57–59](#)
  - for division, [103–107](#)
  - machine language, [194–196](#)
  - for multiplication, [101–103](#)

- shift arithmetic right instruction, [192](#)
- shift left instruction, [192](#)
- shift logical right instruction, [192](#)
- SHL [instruction class] shift left, [192](#), [195](#)
- SHLT [Y86–64] status code for `halt`, [404](#)
- short counts, [895](#)
- `short` [C] integer data type, [40](#), [61](#)
- SHR [instruction class] shift logical right, [192](#), [195](#)
- `%si` [x86–64] low order 16 bits of register `%rsi`, [180](#)
- side effects, [500](#)
- `sig_atomic_t` type, [770](#)
- `sigaction` [Unix] install portable handler, [775](#)
- `sigaddset` [Unix] add signal to signal set, [765](#)
- `sigdelset` [Unix] delete signal from signal set, [765](#)
- `sigemptyset` [Unix] clear a signal set, [765](#)
- `sigfillset` [Unix] add every signal to signal set, [765](#)
- `sigint.c` [CS:APP] catches SIGINT signal, [763](#)
- `sigismember` [Unix] test signal set membership, [765](#)
- `siglongjmp` [Unix] init nonlocal jump, [783](#), [785](#)
- sign bits
  - floating-point representation, [137](#)
  - two's complement representation, [64](#)
- sign extension, [77](#), [77](#), [183–184](#)
- sign flag condition code, [201](#), [355](#)
- sign-magnitude representation, [68](#)
- `Signal` [CS:APP] portable version of `signal`, [775](#)
- signal handlers, [758](#)

- installing, [763](#)
- writing, [766–775](#)
- Y86–64, [364](#)
- `signal1.c` [CS:APP] flawed signal handler, [771](#)
- `signal2.c` [CS:APP] flawed signal handler, [772](#)
- signals, [722](#), [756–758](#)
  - blocking and unblocking, [764–765](#)
  - correct handling, [770–774](#)
  - enabling and disabling, [52](#)
  - flow synchronizing, [776–778](#)
  - portable handling, [774–775](#)
  - processes, [739](#)
  - receiving, [762](#), [762–764](#)
  - safe handling, [766–770](#)
  - sending, [758](#), [759–762](#)
  - terminology, [758–759](#)
  - waiting for, [778–781](#)
  - Y86–64 pipelined implementations, [426–427](#)
- `signed` [C] integer data type, [41](#)
- signed divide instruction, [198](#), [199](#)
- signed integers, [32](#), [40](#), [61–62](#), [67](#)
  - alternate representations, [68](#)
  - shift operations, [58](#)
  - two's complement encoding, [64–70](#)
  - unsigned conversions, [70–76](#)
- signed multiply instruction, [198](#), [198](#)
- signed number representation
  - guidelines, [83–84](#)

- ones' complement, [68](#)
  - sign magnitude, [68](#)
- signed size type, [896](#)
- significands in floating-point representation, [112](#)
- signs for floating-point representation, [112](#), [112–113](#)
- SIGPIPE signal, [964](#)
- `sigprocmask` [Unix] block and unblock signals, [765](#), [781](#)
- `sigsetjmp` [Unix] init nonlocal handler jump, [781](#), [785](#)
- `sigsuspend` [Unix] wait for a signal, [781](#)
- `%sil` [x86–64] low order 8 of register `%rsi`, [180](#)
- SimAquarium game, [637–638](#)
- SIMD (single-instruction, multiple-data) parallelism, [26](#), [294](#), [546](#), [547](#)
- SIMD streaming extensions (SSE) instructions, [276](#)
- simple segregated storage, [863](#), [863–864](#)
- simplicity in instruction processing, [385](#)
- simulated concurrency, [24](#)
- simultaneous multi-threading, [25](#)
- single-bit data connections, [398](#)
- single-instruction, multiple-data (SIMD) parallelism, [26](#), [294](#), [546–547](#)
- single-precision floating-point representation
  - IEEE, [113](#), [113](#)
  - machine-level data, [178](#)
  - support for, [41](#)
- `SINS` [Y86–64] status code for illegal instruction exception, [404](#)
- `sio_error` [CS:APP] safely emit error message and terminate, [766](#), [768](#)

- `sio_ltoa` [CS:APP] safely emit string, **768**
- `sio_putl` [CS:APP] safely emit long int, **766, 768**
- `sio_puts` [CS:APP] safely emit string, **766, 768**
- `sio_strlen` [CS:APP] safely emit string, **768**
- size
  - blocks, **848**
  - caches, **632–633**
  - data, **39–42**
  - word, **8, 39**

[OceanofPDF.com](http://OceanofPDF.com)

- size classes, **863**
- `size_t` [Unix] unsigned size type for designating sizes, **44, 83–84, 86, 99, 896**
- SIZE tool, **713**
- `sizeof` [C] compute size of object, **45, 129–131, 133**
- slashes (/) for root directory, **892**
- `sleep` [Unix] suspend process, **749**
- slow system calls, **774**
- `.so` shared object file, **699**
- `sockaddr` [Unix] generic socket address structure, **933**
- `sockaddr_in` [Unix] Internet-style socket address structure, **933**
- socket addresses, **930**
- socket descriptors, **912, 934**
- `socket` function, **934**
- socket pairs, **930**
- sockets, **892, 930**
- sockets interface, **932, 932–933**
  - `accept` function, **936–937**
  - address structures, **933–934**
  - `bind` function, **935**
  - `connect` function, **934–935**
  - example, **944–947**
  - helper functions, **942–944**
  - host and service conversions, **937–942**
  - `listen` function, **935**
  - `open_clientfd` function, **934–935**
  - `socket` function, **934**



- Software Engineering Institute, **100**
- software exceptions
  - C++ and Java, **786**
  - ECF for, **723–724**
  - vs. hardware, **724**
- Solaris Sun Microsystems operating system, **16, 45**
- solid state disks (SSDs), **591, 600**
  - benefits, **587**
  - operation, **600–602**
- sorting performance, **566–567**
- source files, **3**
- source hosts, **922**
- source programs, **3**
- southbridge chipsets, **588**
- Soviet Union, **931**
- `%sp` [x86–64] low order 16 bits of stack pointer register `%rsp`, **180**
- SPARC
  - five-stage pipelines, **471**
  - RISC processors, **363**
  - Sun Microsystems processor, **45**
- spare cylinders, **596**
- spatial locality, **604**
  - caches, **643–647**
  - exploiting, **614**
- special arithmetic operations, **197–200**
- special control conditions in Y86–64 pipelining
  - detecting, **457–459**
  - handling, **455–457**

- specifiers, operand, [180–182](#)
- speculative execution, [519](#), [519](#), [549–550](#)
- speedup of parallel programs, [1018](#), [1018–1019](#)
- spilling, register, [548–549](#)
- spin loops, [778](#)
- spindles, disks, [590](#)
- `%sp1` [x86–64] low order 8 of stack pointer register `%rsp`, [180](#)
- splitting
  - free blocks, [849–850](#)
  - memory blocks, [847](#)
- `sprintf` [C Stdlib] function, [47](#), [282](#)
- Sputnik, [931](#)
- `sqrtsd` [x86–64] double-precision square root, [302](#)
- `sqrtss` [x86–64] single-precision square root, [302](#)
- square root floating-point instructions, [302](#)
- squashing mispredicted branch handling, [444](#)
- SRAM (static RAM), [13](#), [581](#), [581–582](#) cache. See [caches and cache memory](#) vs. DRAM, [582](#)
  - trends, [602–603](#)
- SRAM cells, [581](#)
- `srand` [CS:APP] pseudorandom number generator seed, [1021](#)
- SSDs (solid state disks), [591](#), [600](#)
  - benefits, [587](#)
  - operation, [600–602](#)
- SSE (streaming SIMD extensions) instructions, [167–168](#), [294](#)
  - alignment exceptions, [276](#)
  - parallelism, [546–547](#)
- `ssize_t` [Unix] signed size type, [896](#)

- stack corruption detection, **286–289**
- stack frames, **240, 240–241**
  - alignment on, **276**
  - variable-size, **290–293**
- stack pointers, **239**
- stack protectors, **286–287**
- stack randomization, **284–286**
- stack storage allocation function, **290, 324**
- stacks, **19, 189, 189–191**
  - bottom, **190**
  - buffer overflow, **871**
  - with `execve` function, **751–752**
  - local storage, **248–251**
  - machine-level programming, **171**
  - overflow. See **buffer overflow**
  - recursive procedures, **253–255**
  - run time, **239–241**
  - top, **190**
  - Y86–64 pipelining, **429**
- stages, SEQ, **384–395**
  - decode and write-back, **406–408**
  - execute, **408–409**
  - fetch, **404–406**
  - memory stage, **409–411**
  - PC update, **411**
- stalling
  - for data hazards, **442**
  - pipeline, **433–436, 459–460**

- Stallman, Richard, [6](#), [16](#)
- standard C library, [4](#), [4–5](#)
- standard error files, [891](#)
- standard I/O library, [911](#), [911](#)
- standard input files, [891](#)
- standard output files, [891](#)
- Standard Unix Specification, [16](#)
- `_start`, [698](#)
- starvation in readers-writers problem, [1008](#)
- `stat` [Unix] fetch file metadata, [903–904](#)
- state machines, [980](#)
- states
  - bistable memory, [581](#)
  - deadlock, [1027](#)
  - processor, [723](#)
  - programmer-visible, [355](#), [355–356](#)
  - progress graphs, [999](#)
  - state machines, [980](#)
- static libraries, [684](#), [684–688](#)
- static linkers, [672](#)
- static linking, [672](#)
- static RAM (SRAM), [13](#), [581–582](#)
  - cache. See [caches and cache memory](#)
  - vs. DRAM, [582](#)
  - trends, [602–603](#)
- `static` [C] variable and function attribute, [676](#), [677](#), [994](#)
- static variables, [994](#), [994–995](#)
- static Web content, [949](#)

- status code registers, [435](#)
- status codes
  - HTTP, [953](#)
  - Y86–64, [363–364](#), [364](#)
- status messages in HTTP, [953](#)
- status register hazards, [435](#)
- `STDERR_FILENO` [Unix] constant for standard error descriptor, [891](#)
- `stderr` stream, [911](#)
- `STDIN_FILENO` [Unix] constant for standard input descriptor, [891](#)
- `stdin` stream, [911](#)
- `stdint.h` file, [67](#)
- `<stdio.h>` [Unix] standard I/O library header file, [84](#), [86](#)
- `stdlib`, [4](#), [4–5](#)
- `STDOUT_FILENO` [Unix] constant for standard output descriptor, [891](#)
- `stdout` stream, [911](#)
- `stepi` command, [280](#)
- `stepi4` command, [280](#)
- Stevens, W. Richard, [903](#), [914](#), [965](#), [1041](#)
- stopped processes, [739](#)
- storage. See also [information storage](#)
  - device hierarchy, [14](#)
  - registers, [251–253](#)
  - stack, [248–251](#)
- storage classes for variables, [994–995](#)
- store buffers, [557–558](#)
- store instructions, [10](#)
- store operations

- example, [588](#)
- processors, [521](#)
- store performance of memory, [555–561](#)
- STRACE tool, [786](#)
- straight-line code, [200–201](#)
- `strcat` [C Stdlib] string concatenation function, [282](#)
- `strcpy` [C Stdlib] string copy function, [282](#)
- streaming SIMD extensions (SSE) instructions, [167–168](#), [294](#)
  - alignment exceptions, [276](#)
  - parallelism, [546–547](#)
- streams, [911](#)
  - buffers, [911](#)
  - directory, [905](#)
  - full duplex, [912](#)
- `strerror` function, [738](#)
- stride-1 reference patterns, [606](#)
- stride-*k* reference patterns, [606](#)
- string concatenation function, [282](#)
- string copy function, [282](#)
- string generation function, [282](#)
- strings
  - in buffer overflow, [279](#), [281](#)
  - length, [83](#)
  - lowercase conversions, [509–511](#)
  - representing, [49](#)
- STRINGS tool, [713](#)
- STRIP tool, [713](#)
- `strlen` [C Stdlib] string length function, [83](#), [509–511](#)

- strong scaling, [1019](#)
- strong symbols, [680](#)
- `.strtab` section, [675](#)
- `strtok` [C Stdlib] string function, [1024](#)
- `struct` [C] structure data type, [265](#)
- structures
  - address, [933–934](#)
  - heterogeneous. See [heterogeneous data structures](#)
  - machine-level programming, [171](#)
- SUB [instruction class] subtract, [192](#)
- subdomains, [927](#)
- `subq` [Y86–64] subtract, [356](#), [388](#)
- substitution, inline, [501](#)
- subtract instruction, [192](#)
- subtract operation in execute stage, [408](#)
- subtraction, floating-point, [302](#)
- `sumarraycols` [CS:APP] column-major sum, [636](#)
- `sumarrayrows` [CS:APP] row-major sum, [635](#), [635](#)
- `sumvec` [CS:APP] vector sum, [634](#), [635–636](#)
- Sun Microsystems, [45](#)
  - five-stage pipelines, [471](#)
  - RISC processors, [363](#)
  - security vulnerability, [100](#)
- supercells, [582](#), [582–583](#)
- superscalar processors, [26](#), [471](#), [518](#)
- supervisor mode, [735](#)
- surfaces, disks, [590](#), [595](#)

- suspend process function, [749](#)
- suspend until signal arrives function, [750](#)
- suspended processes, [739](#)
- swap areas, [833](#)
- swap files, [833](#)
- swap space, [833](#)
- swapped-in pages, [809](#)
- swapped-out pages, [809](#)
- swapping pages, [809](#)
- sweep phase in Mark&Sweep garbage collectors, [867](#)
- Swift, Jonathan, [43](#)
- `switch` [C] multiway branch statement, [232–238](#)
- switches, context, [736–737](#)
- symbol resolution, [673](#), [679](#)
  - duplicate symbol names, [680–684](#)
  - static libraries, [684–688](#)
- symbol tables, [675](#), [675–679](#)
- symbolic links, [892](#)
- symbolic methods, [466](#)
- symbols
  - address translation, [814](#)
  - caches, [617](#)
  - global, [675](#)
  - local, [676](#)
  - relocation, [689–695](#)
  - strong and weak, [680](#)
- `.symtab` section, [675](#)
- synchronization



- flow, [776–778](#)
- Java threads, [1010](#)
- progress graphs, [1000](#)
- threads, [995–999](#)
- progress graphs, [999–1001](#)
- with semaphores. See [semaphores](#)
- synchronization errors, [995](#)
- synchronous DRAM (SDRAM), [586](#)
- synchronous exceptions, [727](#)
- `/sys` filesystem, [736](#)
- `syscall` function, [730](#)
- system bus, [587](#)
- system calls, [17](#), [727](#), [727–728](#)
  - error handling, [737–738](#)
  - Linux/x86–64 systems, [730–731](#)
  - slow, [774](#)
- system-level functions, [730](#)
- system-level I/O
  - closing files, [894–895](#)
  - file metadata, [903–904](#)
  - I/O redirection, [909–910](#)
  - opening files, [893–895](#)
  - packages summary, [911–913](#)
  - reading files, [895–897](#)
  - RIO package, [897–903](#)
  - sharing files, [906–908](#)
  - standard, [911](#)
  - summary, [913–914](#)

- Unix I/O, [890–891](#)
- writing files, [896–897](#)
- system startup function, [698](#)
- System V Unix, [16](#)
  - semaphores, [977](#)
  - shared memory, [977](#)

[OceanofPDF.com](http://OceanofPDF.com)

- *T2B* (two's complement to binary conversion), [60](#), [65](#), [71](#)
- *T2U* (two's complement to unsigned conversion), [60](#), [71](#), [71–73](#)
- tables
  - descriptor, [907](#), [909](#)
  - exception, [725](#), [725](#)
  - GOTs, [705](#), [705–707](#)
  - hash, [567–568](#)
  - header, [674](#), [696](#)
  - jump, [233](#), [234–235](#), [725](#)
  - page, [736](#), [806–808](#), [807](#), [819–821](#), [823](#)
  - program header, [696](#), [696](#)
  - symbol, [675](#), [675–679](#)
- tag bits, [615](#), [616](#)
- tags, boundary, [851](#), [851–854](#), [859](#)
- Tanenbaum, Andrew S., [20](#)
- target functions in interpositioning libraries, [708](#)
- targets, jump, [206](#), [206–209](#)
- TCP (Transmission Control Protocol), [924](#)
- TCP/IP (Transmission Control Protocol/Internet Protocol), [924](#)
- `tcsh` [Unix] Unix shell program, [753](#)
- TELNET remote login program, [950](#), [950–951](#)
- temporal locality, [604](#)
  - blocking for, [647](#)
  - exploiting, [614](#)
- terminate another thread function, [989](#)
- terminate current thread function, [989](#)
- terminate process function, [739](#)
- terminated processes, [739](#)

- terminating
  - processes, [739–743](#)
  - threads, [988–989](#)
- TEST [instruction class] Test, [202](#)
- test byte instruction, [202](#)
- test double word instruction, [202](#)
- test instructions, [202](#)
- test quad word instruction, [202](#)
- test signal set membership instruction, [765](#)
- test word instruction, [202](#)
- `testb` [x86–64] test byte, [202](#)
- testing Y86–64 pipeline design, [465](#)
- `testl` [x86–64] test double word, [202](#)
- `testq` [x86–64] test quad word, [202](#)
- `testw` [x86–64] test word, [202](#)
- text files, [3](#), [891](#), [892](#), [900](#)
- text lines, [891](#), [898](#)
- text representation
  - ASCII, [49](#)
  - Unicode, [50](#)
- `.text` section, [674](#)
- Thompson, Ken, [16](#)
- thrashing
  - direct-mapped caches, [622](#), [622–623](#)
  - pages, [810](#)
- thread contexts, [986](#), [993](#)
- thread IDs (TIDs), [986](#)
- thread-level concurrency, [24–26](#)

- thread-level parallelism, [26](#)
- thread routines, [987](#), [988](#)
- thread-safe functions, [1020](#), [1020–1022](#)
- thread-unsafe functions, [1020](#), [1020–1022](#)
- threads, [17](#), [18](#), [973](#), [985–986](#)
  - concurrent server based on, [991–992](#)
  - creating, [988](#)
  - detaching, [989–990](#)
  - execution model, [986–987](#)
  - initializing, [990](#)
  - library functions for, [1024–1025](#)
  - mapping variables in, [994–995](#)
  - memory models, [993–994](#)
  - for parallelism, [1013–1018](#)
  - Posix, [987–988](#)
  - races, [1025–1027](#)
  - reaping, [989](#)
  - safety issues, [1020–1022](#)
  - shared variables with, [992–995](#), [993](#)
  - synchronizing, [995–999](#)
  - progress graphs, [999–1001](#)
  - with semaphores. See [semaphores](#)
  - terminating, [988–989](#)
- three-stage pipelines, [414–416](#)
- throughput, [524](#)
  - dynamic memory allocators, [845](#)
  - pipelining for. See [pipelining read](#), [639](#)
- throughput bounds, [518](#), [524](#)

- TIDs (thread IDs), **986**
- time slicing, **733**
- timing, SEQ, **400–403**
- **TINY** [CS:APP] Web server, **956, 956–964**
- TLB index (TLBI), **817**
- TLB tags (TLBT), **817, 823**
- TLBI (TLB index), **817**
- TLBs (translation lookaside buffers), **470, 817, 817–825**
- TLBT (TLB tags), **817, 823**
- *TMax* (maximum two's complement number), **60, 65, 66**
- *TMin* (minimum two's complement number), **60, 65, 66, 77**
- top of stack, **190, 190**
- TOP tool, **786**
- topological sorts of vertices, **742**
- Torvalds, Linus, **20**
- touching pages, **833**
- TRACE method, **951**
- tracing execution, **387, 394–395, 403**
- track density of disks, **591**
- tracks, disk, **590, 595**
- trajectories in progress graphs, **1000, 1000**
- transactions
  - bus, **587, 588–589**
  - client-server model, **918**
  - client-server vs. database, **919**
  - HTTP, **950–953**
- transfer time for disks, **594**
- transfer units, **612**

- transferring control, [241–245](#)
- transformations, reassociation, [541](#), [541–546](#), [570](#)
- transistors in Moore's Law, [169](#)
- transitions
  - progress graphs, [999](#)
  - state machines, [980](#)
- translating programs, [4–5](#)
- translation
  - address. See [address translation](#)
  - `switch` statements, [233](#)
- translation lookaside buffers (TLBs), [470](#), [817](#), [817–825](#)
- Transmission Control Protocol (TCP), [924](#)
- Transmission Control Protocol/Internet Protocol (TCP/IP), [924](#)
- trap exception class, [727](#)
- traps, [727](#), [727–728](#)
- tree height reduction, [570](#)
- tree structure, [270–271](#)
- truncating numbers, [81–82](#)
- two-operand multiply instructions, [198](#)
- two-way parallelism, [536–537](#)
- two's-complement representation
  - addition, [90–95](#)
  - asymmetric range, [66](#), [77](#)
  - bit-level representation, [96](#)
  - encodings, [32](#)
  - minimum value, [65](#)
  - multiplication, [97–101](#)
  - negation, [95](#)

- signed and unsigned conversions, [70–74](#)
- signed numbers, [64](#), [64–70](#)
- `typedef` [C] type definition, [44](#), [47](#)
- types
  - conversions. See [conversions](#)
  - floating point, [124–126](#)
  - integral, [60](#), [60–62](#)
  - machine-level, [171](#), [177–178](#)
  - MIME, [949](#)
  - naming, [47](#)
  - pointers, [36](#), [277](#)
  - pointers associated with, [34](#)



- *U2B* (unsigned to binary conversion), [60](#), [64](#), [71](#), [74](#)
- *U2T* (unsigned to two's-complement conversion), [60](#), [71](#), [73](#), [82](#)
- `ucomisd` [x86–64] compare double precision, [306](#)
- `ucomiss` [x86–64] compare single precision, [306](#)
- UDP (Unreliable Datagram Protocol), [924](#)
- `UINT_MAX` constant, maximum unsigned integer, [68](#)
- `UINT N_MAX` [C] maximum value of *N*-bit unsigned data type, [67](#)
- `uint N_t` [C] *N*-bit unsigned integer data type, [67](#)
- `umask` function, [894–895](#)
- *UMax* (maximum unsigned number), [63](#), [66–67](#)
- unallocated pages, [805](#)
- unary operations, [194](#)
- unblocking signals, [764–765](#)
- unbuffered input and output, [897–898](#)
- uncached pages, [806](#)
- unconditional jump instruction, [357](#)
- underflow, gradual, [115](#)
- Unicode characters, [50](#)
- unified caches, [631](#)
- uniform resource identifiers (URIs), [951](#)
- uninitialized memory, reading, [871](#)
- unions, [44](#), [269–273](#)
- uniprocessor systems, [16](#), [24](#)
- United States, ARPA creation in, [931](#)
- universal resource locators (URLs), [949](#)
- Universal Serial Bus (USB), [596](#)
- Unix 4.xBSD, [16](#), [932](#)

- `unix_error` [CS:APP] reports Unix-style errors, [738](#), [738](#), [1043](#)
- Unix IPC, [977](#)
- Unix operating systems, [16](#), [16](#), [35](#)
  - constants, [746](#)
  - error handling, [1043](#), [1043](#)
  - I/O, [19](#), [890](#), [890–891](#)
- Unix signals, [759](#)
- unlocking mutexes, [1003](#)
- unmap disk object function, [839](#)
- unordered, floating-point comparison outcome, [306](#)
- unpack and interleave low packed double precision instruction, [298](#)
- unpack and interleave low packed single precision instruction, [298](#)
- Unreliable Datagram Protocol (UDP), [924](#)
- unrolling
- $k \times 1$ , [531](#)
- $k \times 1a$ , [544](#)
- $k \times k$ , [539–540](#)
  - loops, [502](#), [504](#), [531](#), [531–535](#), [572](#)
- unsafe regions in progress graphs, [1000](#)
- unsafe trajectories in progress graphs, [1000](#)
- `unsetenv` [Unix] delete environment variable, [752](#)
- `unsigned` [C] integer data type, [41](#), [61](#)
- unsigned representations, [83–84](#)
  - addition, [84–90](#)
  - conversions, [70–76](#)
  - division, [198](#), [199](#)

- encodings, [32](#), [62–64](#)
- integers, [40](#)
- maximum value, [63](#)
- multiplication, [96–97](#), [198](#), [198](#)
- `unsigned` size type, [896](#)
- update instructions, [9–10](#)
- URIs (uniform resource identifiers), [951](#)
- URLs (universal resource locators), [949](#)
- USB (Universal Serial Bus), [596](#)
- user-level memory mapping, [837–839](#)
- user mode, [726](#)
  - processes, [734–736](#), [735](#)
  - regular functions in, [728](#)
- user stack, [19](#)
- UTF-8 characters, [50](#)

- `v` [CS:APP] wrapper function for Posix `sem_post`, [1002](#)
- v-node tables, [906](#)
- V semaphore operation, [1001](#), [1001–1002](#)
- VA. See [virtual addresses \(VA\)](#)
- `vaddsd` [x86–64] double-precision addition, [302](#)
- `vaddss` [x86–64] single-precision addition, [302](#)
- VALGRIND program, [569](#)
- valid bit
  - cache lines, [615](#)
  - page tables, [807](#)
- values, pointers, [36](#), [277](#)
- `vandpd` [x86–64] and packed double precision, [305](#)
- `vandps` [x86–64] and packed single precision, [305](#)
- variable-size stack frames, [290–293](#)
- variable-size arrays, [262–265](#)
- variables
  - mapping, [994–995](#)
  - nonexistent, [874](#)
  - shared, [992–995](#), [993](#)
  - storage classes, [994–995](#)
- VAX computers (Digital Equipment Corporation), Boolean operations, [56](#)
- `vcvtps2pd` [x86–64] convert packed single to packed double precision, [298](#)
- `vcvtsi2sd` [x86–64] convert integer to double precision, [297](#)
- `vcvtsi2sdq` [x86–64] convert quad-word integer to double precision, [297](#)

- `vcvtsi2ss` [x86–64] convert integer to single precision, [297](#)
- `vcvtsi2ssq` [x86–64] convert quad-word integer to single precision, [297](#)
- `vcvttsd2si` [x86–64] convert double precision to integer, [297](#)
- `vcvttsd2siq` [x86–64] convert double precision to quad-word integer, [297](#)
- `vcvttss2si` [x86–64] convert single precision to integer, [297](#)
- `vcvttss2siq` [x86–64] convert single precision to quad-word integer, [297](#)
- `vdivsd` [x86–64] double-precision division, [302](#)
- `vdivss` [x86–64] single-precision division, [302](#)
- vector data types, [26](#), [504–507](#)
- vector dot product function, [622](#)
- vector registers, [171](#), [546](#)
- vector sum function, [634](#), [635–636](#)
- vectors, bit, [51](#), [51–52](#)
- verification in pipelining, [466](#)
- Verilog hardware description language for logic design, [373](#)
  - Y86–64 pipelining implementation, [467](#)
- vertical bars `||` for OR operation, [373](#)
- VHDL hardware description language, [373](#)
- victim blocks, [612](#)
- Video RAM (VRAM), [586](#)
- virtual address spaces, [18](#), [34](#), [804](#)
- virtual addresses (VA)
  - machine-level programming, [170–171](#)
  - vs. physical, [803–804](#)

- Y86–64, **356**
- virtual machines
  - as abstraction, **27**
  - Java byte code, **310**
- virtual memory (VM), **15, 18, 34, 802**
  - as abstraction, **27**
  - address spaces, **804–805**
  - address translation. See **address translation**
  - bugs, **870–875**
  - for caching, **805–811**
  - characteristics, **802–803**
  - Core i7, **825–828**
  - dynamic memory allocation. See **dynamic memory allocation**
  - garbage collection, **865–870**
  - Linux, **830–833**
  - in loading, **699**
  - managing, **839**
  - mapping. See **memory mapping**
  - for memory management, **811–812**
  - for memory protection, **812–813**
  - overview, **18–19**
  - physical vs. virtual addresses, **803–804**
  - summary, **875–876**
- virtual page numbers (VPNs), **814**
- virtual page offset (VPO), **814**
- virtual pages (VPs), **289, 805, 805–806**
- viruses, **285–286**

- VLOG implementation of Y86–64
  - pipelining, [467](#)
- VM. See [virtual memory \(VM\)](#)
- `vmaxsd` [x86–64] double-precision maximum, [302](#)
- `vmaxss` [x86–64] single-precision maximum, [302](#)
- `vminsd` [x86–64] double-precision minimum, [302](#)
- `vminss` [x86–64] single-precision minimum, [302](#)
- `vmovapd` [x86–64] move aligned, packed double precision, [296](#)
- `vmovaps` [x86–64] move aligned, packed single precision, [296](#)
- `vmovsd` [x86–64] move double precision, [296](#)
- `vmovss` [x86–64] move single precision, [296](#)
- `vmulsd` [x86–64] double-precision multiplication, [302](#)
- `vmulss` [x86–64] single-precision multiplication, [302](#)
- `void*` [C] untyped pointers, [48](#)
- `volatile` [C] volatile type qualifier, [769–770](#)
- VP (virtual pages), [289](#), [805](#), [805–806](#)
- VPNs (virtual page numbers), [814](#)
- VPO (virtual page offset), [814](#)
- VRAM (video RAM), [586](#)
- `vsubsd` [x86–64] double-precision subtraction, [302](#)
- `vsubss` [x86–64] single-precision subtraction, [302](#)
- VTUNE program, [569](#)
- vulnerabilities, security, [86–87](#)
- `vunpcklpd` [x86–64] unpack and interleave low packed double precision, [298](#)

- `vunpcklps` [x86–64] unpack and interleave low packed single precision, **298**
- `vxorpd` [x86–64] EXCLUSIVE-OR packed double precision, **305**
- `vxorps` [x86–64] EXCLUSIVE-OR packed single precision, **305**

[OceanofPDF.com](http://OceanofPDF.com)



- `wait` [Unix] wait for child process, [746](#)
- wait for child process functions, [744](#), [746–749](#)
- wait for client connection request function, [936](#), [936–937](#)
- wait for signal instruction, [781](#)
- `wait.h` file, [746](#)
- wait sets, [744](#), [744](#)
- waiting for signals, [778–781](#)
- `waitpid` [Unix] wait for child process, [743](#), [746–749](#)
- `waitpid1` [CS:APP] `waitpid` example, [747](#)
- `waitpid2` [CS:APP] `waitpid` example, [749](#)
- WANs (wide area networks), [921](#), [921–922](#)
- warming up caches, [612](#)
- WCONTINUED constant, [744](#)
- weak scaling, [1019](#), [1020](#)
- weak symbols, [680](#)
- wear leveling logic, [601](#)
- Web clients, [948](#), [948](#)
- Web servers, [701](#), [948](#)
  - basics, [948–949](#)
  - dynamic content, [953–954](#)
  - HTTP transactions, [950–953](#)
  - `TINY` example, [956–964](#)
  - Web content, [949–950](#)
- well-known ports, [930](#)
- well-known service names, [930](#)
- `while` [C] loop statement, [223–228](#)
- wide area networks (WANs), [921](#), [921–922](#)

- WIFEXITED constant, [745](#)
- WIFEXITSTATUS constant, [745](#)
- WIFSIGNALED constant, [745](#)
- WIFSTOPPED constant, [745](#)
- Windows Microsoft operating system, [27](#), [45](#)
- wire names in hardware diagrams, [398](#)
- WNOHANG constant, [744–745](#)
- word-level combinational circuits, [376–380](#)
- word selection
  - direct-mapped caches, [619](#)
  - fully associative caches, [627–628](#)
  - set associative caches, [625–626](#)
- word size, [8](#), [39](#)
- words, [8](#), [177](#)
- working sets, [613](#), [810](#)
- world-wide data connections in hardware diagrams, [398](#)
- World Wide Web, [949](#)
- worm programs, [284–286](#)
- wrapper functions, [711](#)
  - error handling, [738](#), [1041](#), [1043–1045](#)
  - interpositioning libraries, [708](#)
- write access, [289](#)
- write-allocate approach, [630](#)
- write-back approach, [630](#)
- write-back stage
  - instruction processing, [385](#), [387–397](#)
  - PIPE processor, [449–453](#)
  - sequential processing, [400](#)

- sequential Y86–64 implementation, **406–408**
- `write` [Unix] write file, **895, 896–897**
- write hits, **630**
- write issues for caches, **630–631**
- write-only register, **527**
- write operations for files, **891, 896–897**
- write ports
  - priorities, **408**
  - register files, **382**
- write/read dependencies, **557–559**
- write strategies for caches, **633**
- write-through approach, **630**
- write transactions, **587, 588–589**
- `writen` function, **903**
- writers in readers-writers problem, **1006, 1008**
- writing
  - signal handlers, **766–775**
  - SSD operations, **600**
- WSTOPSIG constant, **745**
- WTERMSIG constant, **745**
- WUNTRACED constant, **744–745**

- x86 Intel microprocessor line, **166**
- x86–64 instruction set architecture vs. Y86–64, **360**
- x86–64 microprocessors, **168**
  - array access, **256**
  - conditional move instructions, **214–220**
  - data alignment, **276**
  - exceptions, **729–731**
  - Intel-compatible 64-bit microprocessors, **45**
  - machine language, **165–166**
  - registers
    - data movement, **182–189**
    - operand specifiers, **180–182**
    - vs. Y86–64, **365–366**
- x87 microprocessors, **167**
- XDR library security vulnerability, **100**
- `%xmm` [x86–64] 16-byte media register. Subregion of YMM, **295**
- `%xmm0`, return floating-point value register, **299, 301**
- XMM, SSE vector registers, **294–296**
- XOR [instruction class] EXCLUSIVE-OR, **192**
- `xorq` [Y86–64] EXCLUSIVE-OR, **356**

- Y86–64 instruction set architecture, **353–354**
  - details, **370–372**
  - exception handling, **363–364**
  - hazards, **435**
  - instruction encoding, **358–360**
  - instruction set, **356–358**
  - programmer-visible state, **355–356**
  - programs, **364–370**
  - sequential implementation.
  - See **sequential Y86–64 implementation**
  - vs. x86–64, **360**
- Y86–64 pipelined implementations, **421**
  - computation stages, **421–422**
  - control logic. See **control logic in pipelining**
  - exception handling, **444–447**
  - hazards. See **hazards in pipelining**
  - memory system interfacing, **469–470**
  - multicycle instructions, **468–469**
  - performance analysis, **464–468**
  - predicted values, **427–429**
  - register insertions, **422–426**
  - signals, **426–427**
  - stages. See **PIPE processor stages**
  - testing, **465**
  - verification, **466**
  - Verilog, **467**
  - YAS Y86–64 assembler, **366**
  - YIS Y86–64 instruction set simulator, **366**

- `%ymm` [x86–64] 32-byte media register, **295**
- YMM, AVX vector registers, **294–296**

[OceanofPDF.com](http://OceanofPDF.com)

- zero extension, [77](#)
- zero flag condition code, [201](#), [306](#), [355](#)
- `ZF` [x86–64] zero flag condition code, [201](#), [306](#), [355](#)
- zombie processes, [743](#), [743–744](#), [770](#)
- zones, recording, [592](#)

[OceanofPDF.com](http://OceanofPDF.com)

# Contents

1. **Computer Systems A Programmer's Perspective**
2. **Computer Systems A Programmer's Perspective**
3. **MasteringEngineering®**
4. **Contents**
5. **Preface**
  - A. **Assumptions about the Reader's Background**
  - B. **How to Read the Book**
  - C. **Book Overview**
  - D. **New to This Edition**
  - E. **Origins of the Book**
  - F. **For Instructors: Courses Based on the Book**
  - G. **For Instructors: Classroom-Tested Laboratory Exercises**
6. **About the Authors**
7. **Chapter 1 A Tour of Computer Systems**
  - A. **1.1 Information Is Bits + Context**
  - B. **1.2 Programs Are Translated by Other Programs into Different Forms**
  - C. **1.3 It Pays to Understand How Compilation Systems Work**
  - D. **1.4 Processors Read and Interpret Instructions Stored in Memory**
    1. **1.4.1 Hardware Organization of a System**
      - a. **Buses**



- b. **I/O Devices**
- c. **Main Memory**
- d. **Processor**

## 2. **1.4.2 Running the `hello` Program**

### E. **1.5 Caches Matter**

### F. **1.6 Storage Devices Form a Hierarchy**

### G. **1.7 The Operating System Manages the Hardware**

#### 1. **1.7.1 Processes**

#### 2. **1.7.2 Threads**

#### 3. **1.7.3 Virtual Memory**

#### 4. **1.7.4 Files**

### H. **1.8 Systems Communicate with Other Systems Using Networks**

### I. **1.9 Important Themes**

#### 1. **1.9.1 Amdahl's Law**

a. **Practice Problem 1.1 (solution page 28)**

b. **Practice Problem 1.2 (solution page 28)**

#### 2. **1.9.2 Concurrency and Parallelism**

a. **Thread-Level Concurrency**

b. **Instruction-Level Parallelism**

c. **Single-Instruction, Multiple-Data (SIMD) Parallelism**

#### 3. **1.9.3 The Importance of Abstractions in Computer Systems**

- J. **1.10 Summary**
- K. **Bibliographic Notes**

## 8. **Part I Program Structure and Execution**

### A. **Chapter 2 Representing and Manipulating Information**

#### 1. **2.1 Information Storage**

##### a. **2.1.1 Hexadecimal Notation**

- a. **Practice Problem 2.1 (solution page 143)**
- b. **Practice Problem 2.2 (solution page 143)**
- c. **Practice Problem 2.3 (solution page 144)**
- d. **Practice Problem 2.4 (solution page 144)**

##### b. **2.1.2 Data Sizes**

##### c. **2.1.3 Addressing and Byte Ordering**

- a. **Practice Problem 2.5 (solution page 144)**
- b. **Practice Problem 2.6 (solution page 145)**

##### d. **2.1.4 Representing Strings**

- a. **Practice Problem 2.7 (solution page 145)**

##### e. **2.1.5 Representing Code**

##### f. **2.1.6 Introduction to Boolean Algebra**

- a. **Practice Problem 2.8 (solution page 145)**
- b. **Practice Problem 2.9 (solution page 146)**

##### g. **2.1.7 Bit-Level Operations in C**

- a. **Practice Problem 2.10 (solution page 146)**
- b. **Practice Problem 2.11 (solution page 146)**

- c. **Practice Problem 2.12 (solution page 146)**
    - d. **Practice Problem 2.13 (solution page 147)**
  - h. **2.1.8 Logical Operations in C**
    - a. **Practice Problem 2.14 (solution page 147)**
    - b. **Practice Problem 2.15 (solution page 148)**
  - i. **2.1.9 Shift Operations in C**
    - a. **Practice Problem 2.16 (solution page 148)**
- 2. **2.2 Integer Representations**
  - a. **2.2.1 Integral Data Types**
  - b. **2.2.2 Unsigned Encodings**
  - c. **2.2.3 Two's-Complement Encodings**
    - a. **Practice Problem 2.17 (solution page 148)**
    - b. **Practice Problem 2.18 (solution page 149)**
  - d. **2.2.4 Conversions between Signed and Unsigned**
    - a. **Practice Problem 2.19 (solution page 149)**
    - b. **Practice Problem 2.20 (solution page 149)**
  - e. **2.2.5 Signed versus Unsigned in C**
    - a. **Practice Problem 2.21 (solution page 149)**
  - f. **2.2.6 Expanding the Bit Representation of a Number**
    - a. **Practice Problem 2.22 (solution page 150)**
    - b. **Practice Problem 2.23 (solution page 150)**

- g. **2.2.7 Truncating Numbers**
  - a. **Practice Problem 2.24 (solution page 150)**
  
- h. **2.2.8 Advice on Signed versus Unsigned**
  - a. **Practice Problem 2.25 (solution page 151)**
  - b. **Practice Problem 2.26 (solution page 151)**
  
- 3. **2.3 Integer Arithmetic**
  - a. **2.3.1 Unsigned Addition**
    - a. **Practice Problem 2.27 (solution page 152)**
    - b. **Practice Problem 2.28 (solution page 152)**
  
  - b. **2.3.2 Two's-Complement Addition**
    - a. **Practice Problem 2.29 (solution page 152)**
    - b. **Practice Problem 2.30 (solution page 153)**
    - c. **Practice Problem 2.31 (solution page 153)**
    - d. **Practice Problem 2.32 (solution page 153)**
  
  - c. **2.3.3 Two's-Complement Negation**
    - a. **Practice Problem 2.33 (solution page 153)**
  
  - d. **2.3.4 Unsigned Multiplication**
  - e. **2.3.5 Two's-Complement Multiplication**
    - a. **Practice Problem 2.34 (solution page 153)**
    - b. **Practice Problem 2.35 (solution page 154)**
    - c. **Practice Problem 2.36 (solution page 154)**
    - d. **Practice Problem 2.37 (solution page 155)**

- f. **2.3.6 Multiplying by Constants**
  - a. **Practice Problem 2.38 (solution page 155)**
  - b. **Practice Problem 2.39 (solution page 156)**
  - c. **Practice Problem 2.40 (solution page 156)**
  - d. **Practice Problem 2.41 (solution page 156)**
  
- g. **2.3.7 Dividing by Powers of 2**
  - a. **Practice Problem 2.42 (solution page 156)**
  - b. **Practice Problem 2.43 (solution page 157)**
  
- h. **2.3.8 Final Thoughts on Integer Arithmetic**
  - a. **Practice Problem 2.44 (solution page 157)**
  
- 4. **2.4 Floating Point**
  - a. **2.4.1 Fractional Binary Numbers**
    - a. **Practice Problem 2.45 (solution page 157)**
    - b. **Practice Problem 2.46 (solution page 158)**
  
  - b. **2.4.2 IEEE Floating-Point Representation**
  - c. **2.4.3 Example Numbers**
    - a. **Practice Problem 2.47 (solution page 158)**
    - b. **Practice Problem 2.48 (solution page 159)**
    - c. **Practice Problem 2.49 (solution page 159)**
  
  - d. **2.4.4 Rounding**
    - a. **Practice Problem 2.50 (solution page 159)**
    - b. **Practice Problem 2.51 (solution page 159)**
    - c. **Practice Problem 2.52 (solution page 160)**

- e. **2.4.5 Floating-Point Operations**
- f. **2.4.6 Floating Point in C**
  - a. **Practice Problem 2.53 (solution page 160)**
  - b. **Practice Problem 2.54 (solution page 160)**

5. **2.5 Summary**

6. **Bibliographic Notes**

7. **Homework Problems**

- a. **2.55** ♦
- b. **2.56** ♦
- c. **2.57** ♦
- d. **2.58** ♦♦
- e. **2.59** ♦♦
- f. **2.60** ♦♦
- g. **Bit-Level Integer Coding Rules**
- h. **2.61** ♦♦
- i. **2.62** ♦♦♦
- j. **2.63** ♦♦♦
- k. **2.64** ♦
- l. **2.65** ♦♦♦♦
- m. **2.66** ♦♦♦♦
- n. **2.67** ♦♦
- o. **2.68** ♦♦
- p. **2.69** ♦♦♦
- q. **2.70** ♦♦
- r. **2.71**
- s. **2.72**
- t. **2.73**

- u. [2.74](#)
- v. [2.75](#)
- w. [2.76](#)
- x. [2.77](#)
- y. [2.78](#)
- z. [2.79](#)
- aa. [2.80](#)
- ab. [2.81](#)
- ac. [2.82](#)
- ad. [2.83](#)
- ae. [2.84](#)
- af. [2.85](#)
- ag. [2.86](#)
- ah. [2.87](#)
- ai. [2.88](#)
- aj. [2.89](#)
- ak. [2.90](#)
- al. [2.91](#)
- am. [Bit-Level Floating-Point Coding Rules](#)
- an. [2.92](#) ♦♦
- ao. [2.94](#)
- ap. [2.95](#)
- aq. [2.96](#)
- ar. [2.97](#)

## B. [Chapter 3 Machine-Level Representation of Programs](#)

1. [3.1 A Historical Perspective](#)
2. [3.2 Program Encodings](#)

- a. **3.2.1 Machine-Level Code**
  - b. **3.2.2 Code Examples**
  - c. **3.2.3 Notes on Formatting**
3. **3.3 Data Formats**
4. **3.4 Accessing Information**
- a. **3.4.1 Operand Specifiers**
    - a. **Practice Problem 3.1 (solution page 325)**
  - b. **3.4.2 Data Movement Instructions**
    - a. **Practice Problem 3.2 (solution page 325)**
    - b. **Practice Problem 3.3 (solution page 326)**
  - c. **3.4.3 Data Movement Example**
    - a. **Practice Problem 3.4 (solution page 326)**
    - b. **Practice Problem 3.5 (solution page 327)**
  - d. **3.4.4 Pushing and Popping Stack Data**
5. **3.5 Arithmetic and Logical Operations**
- a. **3.5.1 Load Effective Address**
    - a. **Practice Problem 3.6 (solution page 327)**
    - b. **Practice Problem 3.7 (solution page 328)**
  - b. **3.5.2 Unary and Binary Operations**
    - a. **Practice Problem 3.8 (solution page 328)**
  - c. **3.5.3 Shift Operations**



- a. **Practice Problem 3.9 (solution page 328)**
  
- d. **3.5.4 Discussion**
  - a. **Practice Problem 3.10 (solution page 329)**
  - b. **Practice Problem 3.11 (solution page 329)**
  
- e. **3.5.5 Special Arithmetic Operations**
  - a. **Practice Problem 3.12 (solution page 329)**
  
- 6. **3.6 Control**
  - a. **3.6.1 Condition Codes**
  - b. **3.6.2 Accessing the Condition Codes**
    - a. **Practice Problem 3.13 (solution page 330)**
    - b. **Practice Problem 3.14 (solution page 330)**
  
  - c. **3.6.3 Jump Instructions**
  - d. **3.6.4 Jump Instruction Encodings**
    - a. **Practice Problem 3.15 (solution page 330)**
  
  - e. **3.6.5 Implementing Conditional Branches with Conditional Control**
    - a. **Practice Problem 3.16 (solution page 331)**
    - b. **Practice Problem 3.17 (solution page 331)**
    - c. **Practice Problem 3.18 (solution page 332)**
  
  - f. **3.6.6 Implementing Conditional Branches with Conditional Moves**
    - a. **Practice Problem 3.19 (solution page 332)**

- b. **Practice Problem 3.20 (solution page 333)**
    - c. **Practice Problem 3.21 (solution page 333)**
  - g. **3.6.7 Loops**
    - a. **Do-While Loops**
      - a. **Practice Problem 3.22 (solution page 333)**
      - b. **Practice Problem 3.23 (solution page 334)**
    - b. **While Loops**
      - a. **Practice Problem 3.24 (solution page 335)**
      - b. **Practice Problem 3.25 (solution page 335)**
      - c. **Practice Problem 3.26 (solution page 336)**
    - c. **For Loops**
      - a. **Practice Problem 3.27 (solution page 336)**
      - b. **Practice Problem 3.28 (solution page 336)**
      - c. **Practice Problem 3.29 (solution page 337)**
  - h. **3.6.8 Switch Statements**
    - a. **Practice Problem 3.30 (solution page 338)**
    - b. **Practice Problem 3.31 (solution page 338)**
- 7. **3.7 Procedures**
  - a. **3.7.1 The Run-Time Stack**
  - b. **3.7.2 Control Transfer**
    - a. **Practice Problem 3.32 (solution page 339)**
  - c. **3.7.3 Data Transfer**

- a. **Practice Problem 3.33 (solution page 339)**
  - d. **3.7.4 Local Storage on the Stack**
  - e. **3.7.5 Local Storage in Registers**
    - a. **Practice Problem 3.34 (solution page 340)**
  - f. **3.7.6 Recursive Procedures**
    - a. **Practice Problem 3.35 (solution page 340)**
8. **3.8 Array Allocation and Access**
- a. **3.8.1 Basic Principles**
    - a. **Practice Problem 3.36 (solution page 341)**
  - b. **3.8.2 Pointer Arithmetic**
    - a. **Practice Problem 3.37 (solution page 341)**
  - c. **3.8.3 Nested Arrays**
    - a. **Practice Problem 3.38 (solution page 341)**
  - d. **3.8.4 Fixed-Size Arrays**
    - a. **Practice Problem 3.39 (solution page 342)**
    - b. **Practice Problem 3.40 (solution page 342)**
  - e. **3.8.5 Variable-Size Arrays**
9. **3.9 Heterogeneous Data Structures**
- a. **3.9.1 Structures**
    - a. **Practice Problem 3.41 (solution page 343)**

- b. **Practice Problem 3.42 (solution page 343)**
  - b. **3.9.2 Unions**
    - a. **Practice Problem 3.43 (solution page 344)**
  - c. **3.9.3 Data Alignment**
    - a. **Practice Problem 3.44 (solution page 345)**
    - b. **Practice Problem 3.45 (solution page 345)**
- 10. **3.10 Combining Control and Data in Machine-Level Programs**
  - a. **3.10.1 Understanding Pointers**
  - b. **3.10.2 Life in the Real World: Using the GDB Debugger**
  - c. **3.10.3 Out-of-Bounds Memory References and Buffer Overflow**
    - a. **Practice Problem 3.46 (solution page 346)**
  - d. **3.10.4 Thwarting Buffer Overflow Attacks**
    - a. **Stack Randomization**
      - a. **Practice Problem 3.47 (solution page 347)**
    - b. **Stack Corruption Detection**
      - a. **Practice Problem 3.48 (solution page 347)**
    - c. **Limiting Executable Code Regions**
  - e. **3.10.5 Supporting Variable-Size Stack Frames**

a. **Practice Problem 3.49 (solution page 347)**

11. **3.11 Floating-Point Code**

a. **3.11.1 Floating-Point Movement and Conversion Operations**

a. **Practice Problem 3.50 (solution page 347)**

b. **Practice Problem 3.51 (solution page 348)**

b. **3.11.2 Floating-Point Code in Procedures**

a. **Practice Problem 3.52 (solution page 348)**

c. **3.11.3 Floating-Point Arithmetic Operations**

a. **Practice Problem 3.53 (solution page 348)**

b. **Practice Problem 3.54 (solution page 349)**

d. **3.11.4 Defining and Using Floating-Point Constants**

a. **Practice Problem 3.55 (solution page 349)**

e. **3.11.5 Using Bitwise Operations in Floating-Point Code**

a. **Practice Problem 3.56 (solution page 350)**

f. **3.11.6 Floating-Point Comparison Operations**

a. **Practice Problem 3.57 (solution page 350)**

g. **3.11.7 Observations about Floating-Point Code**

12. **3.12 Summary**

**13. Bibliographic Notes**

**14. Homework Problems**

- a. **3.58**
- b. **3.59**
- c. **3.60**
- d. **3.61**
- e. **3.62**
- f. **3.63**
- g. **3.64**
- h. **3.65**
- i. **3.66**
- j. **3.67**
- k. **3.68**
- l. **3.69**
- m. **3.70**
- n. **3.71**
- o. **3.72**
- p. **3.73**
- q. **3.74**
- r. **3.75**

**C. Chapter 4 Processor Architecture**

**1. 4.1 The Y86-64 Instruction Set Architecture**

- a. **4.1.1 Programmer-Visible State**
- b. **4.1.2 Y86-64 Instructions**
- c. **4.1.3 Instruction Encoding**
  - a. **Practice Problem 4.1 (solution page 480)**
  - b. **Practice Problem 4.2 (solution page 481)**

- d. **4.1.4 Y86-64 Exceptions**
  - e. **4.1.5 Y86-64 Programs**
    - a. **Practice Problem 4.3 (solution page 482)**
    - b. **Practice Problem 4.4 (solution page 482)**
    - c. **Practice Problem 4.5 (solution page 483)**
    - d. **Practice Problem 4.6 (solution page 483)**
  
  - f. **4.1.6 Some Y86-64 Instruction Details**
    - a. **Practice Problem 4.7 (solution page 484)**
    - b. **Practice Problem 4.8 (solution page 484)**
2. **4.2 Logic Design and the Hardware Control Language HCL**
- a. **4.2.1 Logic Gates**
  - b. **4.2.2 Combinational Circuits and HCL Boolean Expressions**
    - a. **Practice Problem 4.9 (solution page 484)**
  
  - c. **4.2.3 Word-Level Combinational Circuits and HCL Integer Expressions**
    - a. **Practice Problem 4.10 (solution page 484)**
    - b. **Practice Problem 4.11 (solution page 484)**
    - c. **Practice Problem 4.12 (solution page 484)**
  
  - d. **4.2.4 Set Membership**
  - e. **4.2.5 Memory and Clocking**
3. **4.3 Sequential Y86-64 Implementations**

- a. **4.3.1 Organizing Processing into Stages**
  - a. **Practice Problem 4.13 (solution page 485)**
  - b. **Practice Problem 4.14 (solution page 486)**
  - c. **Practice Problem 4.15 (solution page 486)**
  - d. **Practice Problem 4.16 (solution page 486)**
  - e. **Practice Problem 4.17 (solution page 486)**
  - f. **Practice Problem 4.18 (solution page 487)**
  
- b. **4.3.2 SEQ Hardware Structure**
- c. **4.3.3 SEQ Timing**
- d. **4.3.4 SEQ Stage Implementations**
  - a. **Fetch Stage**
    - a. **Practice Problem 4.19 (solution page 487)**
  
  - b. **Decode and Write-Back Stages**
    - a. **Practice Problem 4.20 (solution page 488)**
    - b. **Practice Problem 4.21 (solution page 488)**
    - c. **Practice Problem 4.22 (solution page 488)**
  
  - c. **Execute Stage**
    - a. **Practice Problem 4.23 (solution page 488)**
    - b. **Practice Problem 4.24 (solution page 488)**
  
  - d. **Memory Stage**
    - a. **Practice Problem 4.25 (solution page 488)**
    - b. **Practice Problem 4.26 (solution page 489)**
    - c. **Practice Problem 4.27 (solution page 489)**



- e. **PC Update Stage**
  - f. **Surveying SEQ**
4. **4.4 General Principles of Pipelining**
- a. **4.4.1 Computational Pipelines**
  - b. **4.4.2 A Detailed Look at Pipeline Operation**
  - c. **4.4.3 Limitations of Pipelining**
    - a. **Nonuniform Partitioning**
      - a. **Practice Problem 4.28 (solution page 489)**
    - b. **Diminishing Returns of Deep Pipelining**
      - a. **Practice Problem 4.29 (solution page 490)**
  - d. **4.4.4 Pipelining a System with Feedback**
5. **4.5 Pipelined Y86-64 Implementations**
- a. **4.5.1 SEQ+: Rearranging the Computation Stages**
  - b. **4.5.2 Inserting Pipeline Registers**
  - c. **4.5.3 Rearranging and Relabeling Signals**
  - d. **4.5.4 Next PC Prediction**
  - e. **4.5.5 Pipeline Hazards**
    - a. **Avoiding Data Hazards by Stalling**
    - b. **Avoiding Data Hazards by Forwarding**
    - c. **Load/Use Data Hazards**
    - d. **Avoiding Control Hazards**
  - f. **4.5.6 Exception Handling**
  - g. **4.5.7 PIPE Stage Implementations**

- a. **PC Selection and Fetch Stage**
  - a. **Practice Problem 4.30 (solution page 490)**
  
- b. **Decode and Write-Back Stages**
  - a. **Practice Problem 4.31 (solution page 490)**
  - b. **Practice Problem 4.32 (solution page 490)**
  - c. **Practice Problem 4.33 (solution page 491)**
  - d. **Practice Problem 4.34 (solution page 491)**
  
- c. **Execute Stage**
  - a. **Practice Problem 4.35 (solution page 491)**
  
- d. **Memory Stage**
  - a. **Practice Problem 4.36 (solution page 492)**
  
- h. **4.5.8 Pipeline Control Logic**
  - a. **Desired Handling of Special Control Cases**
  - b. **Detecting Special Control Conditions**
  - c. **Pipeline Control Mechanisms**
  - d. **Combinations of Control Conditions**
    - a. **Practice Problem 4.37 (solution page 492)**
    - b. **Practice Problem 4.38 (solution page 492)**
  
- e. **Control Logic Implementation**
  - a. **Practice Problem 4.39 (solution page 493)**
  - b. **Practice Problem 4.40 (solution page 493)**
  - c. **Practice Problem 4.41 (solution page 493)**
  - d. **Practice Problem 4.42 (solution page 493)**

- i. **4.5.9 Performance Analysis**
  - a. **Practice Problem 4.43 (solution page 494)**
  - b. **Practice Problem 4.44 (solution page 494)**
  
- j. **4.5.10 Unfinished Business**
  - a. **Multicycle Instructions**
  - b. **Interfacing with the Memory System**
  
- 6. **4.6 Summary**
  - a. **4.6.1 Y86-64 Simulators**
  
- 7. **Bibliographic Notes**
  
- 8. **Homework Problems**
  - a. **4.45**
  - b. **4.46**
  - c. **4.47**
  - d. **4.48**
  - e. **4.49**
  - f. **4.50**
  - g. **4.51**
  - h. **4.52**
  - i. **4.53**
  - j. **4.54**
  - k. **4.55**
  - l. **4.56**
  - m. **4.57**
  - n. **4.58**
  - o. **4.59**

- D. **Chapter 5 Optimizing Program Performance**
  - 1. **5.1 Capabilities and Limitations of Optimizing Compilers**
    - a. **Practice Problem 5.1 (solution page 573)**
  - 2. **5.2 Expressing Program Performance**
    - a. **Practice Problem 5.2 (solution page 573)**
  - 3. **5.3 Program Example**
  - 4. **5.4 Eliminating Loop Inefficiencies**
    - a. **Practice Problem 5.3 (solution page 573)**
  - 5. **5.5 Reducing Procedure Calls**
  - 6. **5.6 Eliminating Unneeded Memory References**
    - a. **Practice Problem 5.4 (solution page 574)**
  - 7. **5.7 Understanding Modern Processors**
    - a. **5.7.1 Overall Operation**
    - b. **5.7.2 Functional Unit Performance**
    - c. **5.7.3 An Abstract Model of Processor Operation**
      - a. **From Machine-Level Code to Data-Flow Graphs**
      - b. **Other Performance Factors**
        - a. **Practice Problem 5.5 (solution page 575)**
        - b. **Practice Problem 5.6 (solution page 575)**
  - 8. **5.8 Loop Unrolling**
    - a. **Practice Problem 5.7 (solution page 575)**

- 9. **5.9 Enhancing Parallelism**
  - a. **5.9.1 Multiple Accumulators**
  - b. **5.9.2 Reassociation Transformation**
    - a. **Practice Problem 5.8 (solution page 576)**
  
- 10. **5.10 Summary of Results for Optimizing Combining Code**
  
- 11. **5.11 Some Limiting Factors**
  - a. **5.11.1 Register Spilling**
  - b. **5.11.2 Branch Prediction and Misprediction Penalties**
    - a. **Do Not Be Overly Concerned about Predictable Branches**
    - b. **Write Code Suitable for Implementation with Conditional Moves**
      - a. **Practice Problem 5.9 (solution page 576)**
  
- 12. **5.12 Understanding Memory Performance**
  - a. **5.12.1 Load Performance**
  - b. **5.12.2 Store Performance**
    - a. **Practice Problem 5.10 (solution page 577)**
    - b. **Practice Problem 5.11 (solution page 577)**
    - c. **Practice Problem 5.12 (solution page 577)**
  
- 13. **5.13 Life in the Real World: Performance Improvement Techniques**
  
- 14. **5.14 Identifying and Eliminating Performance Bottlenecks**

[OceanofPDF.com](http://OceanofPDF.com)

1. A. 1. a. **5.14.1 Program Profiling**  
b. **5.14.2 Using a Profiler to Guide Optimization**

2. **5.15 Summary**

3. **Bibliographic Notes**

4. **Homework Problems**

- a. **5.13 ♦♦**
- b. **5.14 ♦**
- c. **5.15 ♦**
- d. **5.16 ♦**
- e. **5.17 ♦♦**
- f. **5.18 ♦♦♦**
- g. **5.19 ♦♦♦**

- B. **Chapter 6 The Memory Hierarchy**

1. **6.1 Storage Technologies**

- a. **6.1.1 Random Access Memory**
  - a. **Static RAM**
  - b. **Dynamic RAM**
  - c. **Conventional DRAMs**
  - d. **Memory Modules**
    - a. **Practice Problem 6.1 (solution page 660)**
  - e. **Enhanced DRAMs**
  - f. **Nonvolatile Memory**
  - g. **Accessing Main Memory**

- b. **6.1.2 Disk Storage**

- a. **Disk Geometry**
  - b. **Disk Capacity**
    - a. **Practice Problem 6.2 (solution page 661)**
  - c. **Disk Operation**
    - a. **Practice Problem 6.3 (solution page 661)**
  - d. **Logical Disk Blocks**
    - a. **Practice Problem 6.4 (solution page 661)**
  - e. **Connecting I/O Devices**
  - f. **Accessing Disks**
- 
- c. **6.1.3 Solid State Disks**
    - a. **Practice Problem 6.5 (solution page 662)**
  - d. **6.1.4 Storage Technology Trends**
    - a. **Practice Problem 6.6 (solution page 662)**
- 
- 2. **6.2 Locality**
    - a. **6.2.1 Locality of References to Program Data**
    - b. **6.2.2 Locality of Instruction Fetches**
    - c. **6.2.3 Summary of Locality**
      - a. **Practice Problem 6.7 (solution page 662)**
      - b. **Practice Problem 6.8 (solution page 663)**
- 
- 3. **6.3 The Memory Hierarchy**
    - a. **6.3.1 Caching in the Memory Hierarchy**



- a. **Cache Hits**
- b. **Cache Misses**
- c. **Kinds of Cache Misses**
- d. **Cache Management**

b. **6.3.2 Summary of Memory Hierarchy Concepts**

4. **6.4 Cache Memories**

a. **6.4.1 Generic Cache Memory Organization**

- a. **Practice Problem 6.9 (solution page 663)**

b. **6.4.2 Direct-Mapped Caches**

- a. **Set Selection in Direct-Mapped Caches**
- b. **Line Matching in Direct-Mapped Caches**
- c. **Word Selection in Direct-Mapped Caches**
- d. **Line Replacement on Misses in Direct-Mapped Caches**
- e. **Putting It Together: A Direct-Mapped Cache in Action**
- f. **Conflict Misses in Direct-Mapped Caches**
  - a. **Practice Problem 6.10 (solution page 663)**
  - b. **Practice Problem 6.11 (solution page 663)**

c. **6.4.3 Set Associative Caches**

- a. **Set Selection in Set Associative Caches**
- b. **Line Matching and Word Selection in Set Associative Caches**

- c. **Line Replacement on Misses in Set Associative Caches**
  - d. **6.4.4 Fully Associative Caches**
    - a. **Set Selection in Fully Associative Caches**
    - b. **Line Matching and Word Selection in Fully Associative Caches**
      - a. **Practice Problem 6.12 (solution page 663)**
      - b. **Practice Problem 6.13 (solution page 664)**
      - c. **Practice Problem 6.14 (solution page 664)**
      - d. **Practice Problem 6.15 (solution page 664)**
      - e. **Practice Problem 6.16 (solution page 665)**
  - e. **6.4.5 Issues with Writes**
  - f. **6.4.6 Anatomy of a Real Cache Hierarchy**
  - g. **6.4.7 Performance Impact of Cache Parameters**
    - a. **Impact of Cache Size**
    - b. **Impact of Block Size**
    - c. **Impact of Associativity**
    - d. **Impact of Write Strategy**
5. **6.5 Writing Cache-Friendly Code**
- a. **Practice Problem 6.17 (solution page 665)**
  - b. **Practice Problem 6.18 (solution page 666)**
  - c. **Practice Problem 6.19 (solution page 666)**
  - d. **Practice Problem 6.20 (solution page 666)**

6. **6.6 Putting It Together: The Impact of Caches on Program Performance**

a. **6.6.1 The Memory Mountain**

a. **Practice Problem 6.21 (solution page 666)**

b. **6.6.2 Rearranging Loops to Increase Spatial Locality**

c. **6.6.3 Exploiting Locality in Your Programs**

7. **6.7 Summary**

8. **Bibliographic Notes**

9. **Homework Problems**

a. **6.22**

b. **6.23**

c. **6.24**

d. **6.25**

e. **6.26**

f. **6.27**

g. **6.28**

h. **6.29**

i. **6.30**

j. **6.31**

k. **6.32**

l. **6.33**

m. **6.34**

n. **6.35**

o. **6.36**

p. **6.37**

- q. **6.38**
- r. **6.39**
- s. **6.40**
- t. **6.41**
- u. **6.42**
- v. **6.43**
- w. **6.44**
- x. **6.45**
- y. **6.46**

## **2. Part II Running Programs on a System**

### **A. Chapter 7 Linking**

- 1. 7.1 Compiler Drivers**
- 2. 7.2 Static Linking**
- 3. 7.3 Object Files**
- 4. 7.4 Relocatable Object Files**
- 5. 7.5 Symbols and Symbol Tables**
  - a. Practice Problem 7.1 (solution page 717)**
  
- 6. 7.6 Symbol Resolution**
  - a. 7.6.1 How Linkers Resolve Duplicate Symbol Names**
    - a. Practice Problem 7.2 (solution page 718)**
  
  - b. 7.6.2 Linking with Static Libraries**
  - c. 7.6.3 How Linkers Use Static Libraries to Resolve References**
    - a. Practice Problem 7.3 (solution page 718)**

- 7. **7.7 Relocation**
  - a. **7.7.1 Relocation Entries**
  - b. **7.7.2 Relocating Symbol References**
    - a. **Relocating PC-Relative References**
    - b. **Relocating Absolute References**
      - a. **Practice Problem 7.4 (solution page 718)**
      - b. **Practice Problem 7.5 (solution page 718)**
  
- 8. **7.8 Executable Object Files**
- 9. **7.9 Loading Executable Object Files**
- 10. **7.10 Dynamic Linking with Shared Libraries**
- 11. **7.11 Loading and Linking Shared Libraries from Applications**
- 12. **7.12 Position-Independent Code (PIC)**
- 13. **7.13 Library Interpositioning**
  - a. **7.13.1 Compile-Time Interpositioning**
  - b. **7.13.2 Link-Time Interpositioning**
  - c. **7.13.3 Run-Time Interpositioning**
  
- 14. **7.14 Tools for Manipulating Object Files**
- 15. **7.15 Summary**
- 16. **Bibliographic Notes**
- 17. **Homework Problems**
  - a. **7.6 ♦**
  - b. **7.7 ♦**
  - c. **7.8 ♦**
  - d. **7.9 ♦**
  - e. **7.10 ♦♦**

- f. **7.11** ♦♦
- g. **7.12** ♦♦
- h. **7.13** ♦♦

## **B. Chapter 8 Exceptional Control Flow**

### **1. 8.1 Exceptions**

- a. **8.1.1 Exception Handling**
- b. **8.1.2 Classes of Exceptions**
  - a. **Interrupts**
  - b. **Traps and System Calls**
  - c. **Faults**
  - d. **Aborts**
- c. **8.1.3 Exceptions in Linux/x86-64 Systems**
  - a. **Linux/x86-64 Faults and Aborts**
  - b. **Linux/x86-64 System Calls**

### **2. 8.2 Processes**

- a. **8.2.1 Logical Control Flow**
- b. **8.2.2 Concurrent Flows**
  - a. **Practice Problem 8.1 (solution page 795)**
- c. **8.2.3 Private Address Space**
- d. **8.2.4 User and Kernel Modes**
- e. **8.2.5 Context Switches**

### **3. 8.3 System Call Error Handling**

### **4. 8.4 Process Control**

- a. **8.4.1 Obtaining Process IDs**
  - b. **8.4.2 Creating and Terminating Processes**
    - a. **Practice Problem 8.2 (solution page 795)**
  - c. **8.4.3 Reaping Child Processes**
    - a. **Determining the Members of the Wait Set**
    - b. **Modifying the Default Behavior**
    - c. **Checking the Exit Status of a Reaped Child**
    - d. **Error Conditions**
      - a. **Practice Problem 8.3 (solution page 797)**
    - e. **The `wait` Function**
    - f. **Examples of Using `waitpid`**
      - a. **Practice Problem 8.4 (solution page 797)**
  - d. **8.4.4 Putting Processes to Sleep**
    - a. **Practice Problem 8.5 (solution page 797)**
  - e. **8.4.5 Loading and Running Programs**
    - a. **Practice Problem 8.6 (solution page 797)**
  - f. **8.4.6 Using `fork` and `execve` to Run Programs**
5. **8.5 Signals**
- a. **8.5.1 Signal Terminology**
  - b. **8.5.2 Sending Signals**
    - a. **Process Groups**
    - b. **Sending Signals with the `/bin/kill` Program**

- c. **Sending Signals from the Keyboard**
  - d. **Sending Signals with the `kill` Function**
  - e. **Sending Signals with the `alarm` Function**
  
- c. **8.5.3 Receiving Signals**
  - a. **Practice Problem 8.7 (solution page 798)**
  
- d. **8.5.4 Blocking and Unblocking Signals**
- e. **8.5.5 Writing Signal Handlers**
  - a. **Safe Signal Handling**
  - b. **Correct Signal Handling**
    - a. **Practice Problem 8.8 (solution page 799)**
  
- c. **Portable Signal Handling**
  
- f. **8.5.6 Synchronizing Flows to Avoid Nasty Concurrency Bugs**
- g. **8.5.7 Explicitly Waiting for Signals**
  
- 6. **8.6 Nonlocal Jumps**
- 7. **8.7 Tools for Manipulating Processes**
- 8. **8.8 Summary**
- 9. **Bibliographic Notes**
- 10. **Homework Problems**
  - a. **8.9 ♦**
  - b. **8.10 ♦**
  - c. **8.11 ♦**
  - d. **8.12 ♦**



- e. **8.13** ♦
- f. **8.14** ♦
- g. **8.15** ♦
- h. **8.16** ♦
- i. **8.17** ♦
- j. **8.18** ♦♦
- k. **8.19** ♦♦
- l. **8.20** ♦♦
- m. **8.21** ♦♦
- n. **8.22** ♦♦♦
- o. **8.23** ♦♦
- p. **8.24** ♦♦♦
- q. **8.25** ♦♦♦
- r. **8.26** ♦♦♦♦

## C. Chapter 9 Virtual Memory

1. **9.1 Physical and Virtual Addressing**
2. **9.2 Address Spaces**
  - a. **Practice Problem 9.1 (solution page 880)**
3. **9.3 VM as a Tool for Caching**
  - a. **9.3.1 DRAM Cache Organization**
  - b. **9.3.2 Page Tables**
    - a. **Practice Problem 9.2 (solution page 881)**
  - c. **9.3.3 Page Hits**
  - d. **9.3.4 Page Faults**
  - e. **9.3.5 Allocating Pages**

- f. **9.3.6 Locality to the Rescue Again**
  
- 4. **9.4 VM as a Tool for Memory Management**
- 5. **9.5 VM as a Tool for Memory Protection**
- 6. **9.6 Address Translation**
  - a. **Practice Problem 9.3 (solution page 881)**
  - b. **9.6.1 Integrating Caches and VM**
  - c. **9.6.2 Speeding Up Address Translation with a TLB**
  - d. **9.6.3 Multi-Level Page Tables**
  - e. **9.6.4 Putting It Together: End-to-End Address Translation**
    - a. **Practice Problem 9.4 (solution page 881)**
  
- 7. **9.7 Case Study: The Intel Core i7/Linux Memory System**
  - a. **9.7.1 Core i7 Address Translation**
  - b. **9.7.2 Linux Virtual Memory System**
    - a. **Linux Virtual Memory Areas**
    - b. **Linux Page Fault Exception Handling**
  
- 8. **9.8 Memory Mapping**
  - a. **9.8.1 Shared Objects Revisited**
  - b. **9.8.2 The `fork` Function Revisited**
  - c. **9.8.3 The `execve` Function Revisited**
  - d. **9.8.4 User-Level Memory Mapping with the `mmap` Function**
    - a. **Practice Problem 9.5 (solution page 882)**

- 9. **9.9 Dynamic Memory Allocation**
  - a. **9.9.1 The `malloc` and `free` Functions**
  - b. **9.9.2 Why Dynamic Memory Allocation?**
  - c. **9.9.3 Allocator Requirements and Goals**
  - d. **9.9.4 Fragmentation**
  - e. **9.9.5 Implementation Issues**
  - f. **9.9.6 Implicit Free Lists**
    - a. **Practice Problem 9.6 (solution page 883)**
  - g. **9.9.7 Placing Allocated Blocks**
  - h. **9.9.8 Splitting Free Blocks**
  - i. **9.9.9 Getting Additional Heap Memory**
  - j. **9.9.10 Coalescing Free Blocks**
  - k. **9.9.11 Coalescing with Boundary Tags**
    - a. **Practice Problem 9.7 (solution page 883)**
  - l. **9.9.12 Putting It Together: Implementing a Simple Allocator**
    - a. **General Allocator Design**
    - b. **Basic Constants and Macros for Manipulating the Free List**
    - c. **Creating the Initial Free List**
    - d. **Freeing and Coalescing Blocks**
    - e. **Allocating Blocks**
      - a. **Practice Problem 9.8 (solution page 884)**
      - b. **Practice Problem 9.9 (solution page 884)**
  - m. **9.9.13 Explicit Free Lists**

- n. **9.9.14 Segregated Free Lists**
  - a. **Simple Segregated Storage**
    - a. **Practice Problem 9.10 (solution page 885)**
  - b. **Segregated Fits**
  - c. **Buddy Systems**
  
- 10. **9.10 Garbage Collection**
  - a. **9.10.1 Garbage Collector Basics**
  - b. **9.10.2 Mark&Sweep Garbage Collectors**
  - c. **9.10.3 Conservative Mark&Sweep for C Programs**
  
- 11. **9.11 Common Memory-Related Bugs in C Programs**
  - a. **9.11.1 Dereferencing Bad Pointers**
  - b. **9.11.2 Reading Uninitialized Memory**
  - c. **9.11.3 Allowing Stack Buffer Overflows**
  - d. **9.11.4 Assuming That Pointers and the Objects They Point to Are the Same Size**
  - e. **9.11.5 Making Off-by-One Errors**
  - f. **9.11.6 Referencing a Pointer Instead of the Object It Points To**
  - g. **9.11.7 Misunderstanding Pointer Arithmetic**
  - h. **9.11.8 Referencing Nonexistent Variables**
  - i. **9.11.9 Referencing Data in Free Heap Blocks**
  - j. **9.11.10 Introducing Memory Leaks**
  
- 12. **9.12 Summary**
- 13. **Bibliographic Notes**

## 14. Homework Problems

- a. **9.11**
- b. **9.12**
- c. **9.13**
- d. **9.14**
- e. **9.15**
- f. **9.16**
- g. **9.17**
- h. **9.18**
- i. **9.19**
- j. **9.20**

## 3. Part III Interaction and Communication between Programs

### A. Chapter 10 System-Level I/O

- 1. **10.1 Unix I/O**
- 2. **10.2 Files**
- 3. **10.3 Opening and Closing Files**
  - a. **Practice Problem 10.1 (solution page 915)**
  
- 4. **10.4 Reading and Writing Files**
- 5. **10.5 Robust Reading and Writing with the R<sub>IO</sub> Package**
  - a. **10.5.1 R<sub>IO</sub> Unbuffered Input and Output Functions**
  - b. **10.5.2 R<sub>IO</sub> Buffered Input Functions**
  
- 6. **10.6 Reading File Metadata**
- 7. **10.7 Reading Directory Contents**
- 8. **10.8 Sharing Files**
  - a. **Practice Problem 10.2 (solution page 915)**

b. **Practice Problem 10.3 (solution page 915)**

9. **10.9 I/O Redirection**

a. **Practice Problem 10.4 (solution page 915)**

b. **Practice Problem 10.5 (solution page 916)**

10. **10.10 Standard I/O**

11. **10.11 Putting It Together: Which I/O Functions Should I Use?**

12. **10.12 Summary**

13. **Bibliographic Notes**

14. **Homework Problems**

a. **10.6**

b. **10.7**

c. **10.8**

d. **10.9**

e. **10.10**

**B. Chapter 11 Network Programming**

1. **11.1 The Client-Server Programming Model**

2. **11.2 Networks**

3. **11.3 The Global IP Internet**

a. **11.3.1 IP Addresses**

a. **Practice Problem 11.1 (solution page 966)**

b. **Practice Problem 11.2 (solution page 967)**

c. **Practice Problem 11.3 (solution page 967)**

b. **11.3.2 Internet Domain Names**

c. **11.3.3 Internet Connections**

4. **11.4 The Sockets Interface**

a. **11.4.1 Socket Address Structures**

b. **11.4.2 The `socket` Function**

c. **11.4.3 The `connect` Function**

d. **11.4.4 The `bind` Function**

e. **11.4.5 The `listen` Function**

f. **11.4.6 The `accept` Function**

g. **11.4.7 Host and Service Conversion**

a. **The `getaddrinfo` Function**

b. **The `getnameinfo` Function**

a. **Practice Problem 11.4 (solution page 968)**

h. **11.4.8 Helper Functions for the Sockets Interface**

a. **The `open_clientfd` Function**

b. **The `open_listenfd` Function**

i. **11.4.9 Example Echo Client and Server**

5. **11.5 Web Servers**

a. **11.5.1 Web Basics**

b. **11.5.2 Web Content**

c. **11.5.3 HTTP Transactions**

a. **HTTP Requests**

b. **HTTP Responses**

- d. **11.5.4 Serving Dynamic Content**
  - a. **How Does the Client Pass Program Arguments to the Server?**
  - b. **How Does the Server Pass Arguments to the Child?**
  - c. **How Does the Server Pass Other Information to the Child?**
  - d. **Where Does the Child Send Its Output?**
    - a. **Practice Problem 11.5 (solution page 969)**

6. **11.6 Putting It Together: The TINY Web Server**

7. **11.7 Summary**

8. **Bibliographic Notes**

9. **Homework Problems**

- a. **11.6**
- b. **11.7**
- c. **11.8**
- d. **11.9**
- e. **11.10**
- f. **11.11**
- g. **11.12**
- h. **11.13**

C. **Chapter 12 Concurrent Programming**

1. **12.1 Concurrent Programming with Processes**

- a. **12.1.1 A Concurrent Server Based on Processes**
- b. **12.1.2 Pros and Cons of Processes**
  - a. **Practice Problem 12.1 (solution page 1036)**





- a. **Practice Problem 12.7 (solution page 1037)**
  - b. **12.5.1 Progress Graphs**
    - a. **Practice Problem 12.8 (solution page 1038)**
  - c. **12.5.2 Semaphores**
  - d. **12.5.3 Using Semaphores for Mutual Exclusion**
  - e. **12.5.4 Using Semaphores to Schedule Shared Resources**
    - a. **Producer-Consumer Problem**
      - a. **Practice Problem 12.9 (solution page 1038)**
    - b. **Readers-Writers Problem**
      - a. **Practice Problem 12.10 (solution page 1038)**
  - f. **12.5.5 Putting It Together: A Concurrent Server Based on Prethreading**
6. **12.6 Using Threads for Parallelism**
7. **12.7 Other Concurrency Issues**
- a. **12.7.1 Thread Safety**
  - b. **12.7.2 Reentrancy**
    - a. **Practice Problem 12.12 (solution page 1038)**
  - c. **12.7.3 Using Existing Library Functions in Threaded Programs**
  - d. **12.7.4 Races**
    - a. **Practice Problem 12.13 (solution page 1039)**
    - b. **Practice Problem 12.14 (solution page 1039)**

e. **12.7.5 Deadlocks**

a. **Practice Problem 12.15 (solution page 1039)**

8. **12.8 Summary**

9. **Bibliographic Notes**

10. **Homework Problems**

a. **12.16** ♦

b. **12.17** ♦

c. **12.18**

d. **12.19** ♦♦

e. **12.20** ♦♦♦

f. **12.21** ♦♦♦♦

g. **12.22** ♦♦

h. **12.23** ♦♦

i. **12.24** ♦

j. **12.25** ♦

k. **12.26** ♦♦♦

l. **12.27** ♦♦

m. **12.28** ♦

n. **12.29** ♦

o. **12.30** ♦

p. **12.31** ♦♦♦

q. **12.32** ♦♦♦

r. **12.33** ♦♦♦

s. **12.34** ♦♦♦

t. **12.35** ♦♦♦

u. **12.36** ♦♦♦

v. **12.37** ♦♦♦

W. **12.38** ◆◆◆◆

X. **12.39** ◆◆◆◆

#### 4. **Appendix A Error Handling**

A. **A.1 Error Handling in Unix Systems**

B. **A.2 Error-Handling Wrappers**

#### 5. **References**

#### 6. **Index**

[OceanofPDF.com](http://OceanofPDF.com)

# List of Illustrations

1. **Figure 1** A typical code example.
2. **Figure 2** Five systems courses based on the CS:APP book.
3. **Figure 1.1** The hello program.
4. **Figure 1.2** The ASCII text representation of hello.c.
5. **Figure 1.3** The compilation system.
6. **Figure 1.4** Hardware organization of a typical system.
7. **Figure 1.5** Reading the hello command from the keyboard.
8. **Figure 1.6** Loading the executable from disk into main memory.
9. **Figure 1.7** Writing the output string from memory to the display.
10. **Figure 1.8** Cache memories.
11. **Figure 1.9** An example of a memory hierarchy.
12. **Figure 1.10** Layered view of a computer system.
13. **Figure 1.11** Abstractions provided by an operating system.
14. **Figure 1.12** Process context switching.
15. **Figure 1.13** Process virtual address space.
16. **Figure 1.14** A network is another I/O device.
17. **Figure 1.15** Using telnet to run hello remotely over a network.

18. **Figure 1.16** Categorizing different processor configurations.
19. **Figure 1.17** Multi-core processor organization.
20. **Figure 1.18** Some abstractions provided by a computer system.
21. **Figure 2.1** Specifying different versions of C to GCC.
22. **Figure 2.2** Hexadecimal notation.
23. **Figure 2.3** Typical sizes (in bytes) of basic C data types.
24. **Figure 2.4** Code to print the byte representation of program objects.
25. **Figure 2.5** Byte representation examples.
26. **Figure 2.6** Byte representations of different data values.
27. **Figure 2.7** Operations of Boolean algebra.
28. **Figure 2.8** Terminology for integer data and arithmetic operations.
29. **Figure 2.9** Typical ranges for C integral data types for 32-bit programs.
30. **Figure 2.10** Typical ranges for C integral data types for 64-bit programs.
31. **Figure 2.11** Guaranteed ranges for C integral data types.
32. **Figure 2.12** Unsigned number examples for
33. **Figure 2.13** Two's-complement number examples for
34. **Figure 2.14** Important numbers.
35. **Figure 2.15** Two's-complement representations of 12,345 and -12,345, and unsigned representation of 53,191.
36. **Figure 2.16** Comparing unsigned and two's-complement representations for

37. **Figure 2.17 Conversion from two's complement to unsigned.**
38. **Figure 2.18 Conversion from unsigned to two's complement.**
39. **Figure 2.19 Effects of C promotion rules.**
40. **Figure 2.20 Examples of sign extension from  $w = 3$  to  $w = 4$ .**
41. **Figure 2.21 Integer addition.**
42. **Figure 2.22 Relation between integer addition and unsigned addition.**
43. **Figure 2.23 Unsigned addition.**
44. **Figure 2.24 Relation between integer and two's-complement addition.**
45. **Figure 2.25 Two's-complement addition examples.**
46. **Figure 2.26 Two's-complement addition.**
47. **Figure 2.27 Three-bit unsigned and two's-complement multiplication examples.**
48. **Figure 2.28 Dividing unsigned numbers by powers of 2.**
49. **Figure 2.29 Applying arithmetic right shift.**
50. **Figure 2.30 Dividing two's-complement numbers by powers of 2.**
51. **Figure 2.31 Fractional binary representation.**
52. **Figure 2.32 Standard floating-point formats.**
53. **Figure 2.33 Categories of single-precision floating-point values.**
54. **Figure 2.34 Representable values for 6-bit floating-point format.**

55. **Figure 2.35 Example nonnegative values for 8-bit floating-point format.**
56. **Figure 2.36 Examples of nonnegative floating-point numbers.**
57. **Figure 2.37 Illustration of rounding modes for dollar rounding.**
58. **Figure 3.1 Sizes of C data types in x86-64.**
59. **Figure 3.2 Integer registers.**
60. **Figure 3.3 Operand forms.**
61. **Figure 3.4 Simple data movement instructions.**
62. **Figure 3.5 Zero-extending data movement instructions.**
63. **Figure 3.6 Sign-extending data movement instructions.**
64. **Figure 3.7 C and assembly code for exchange routine.**
65. **Figure 3.8 Push and pop instructions.**
66. **Figure 3.9 Illustration of stack operation.**
67. **Figure 3.10 Integer arithmetic operations.**
68. **Figure 3.11 C and assembly code for arithmetic function.**
69. **Figure 3.12 Special arithmetic operations.**
70. **Figure 3.13 Comparison and test instructions.**
71. **Figure 3.14 The set instructions.**
72. **Figure 3.15 The jump instructions.**
73. **Figure 3.16 Compilation of conditional statements.**
74. **Figure 3.17 Compilation of conditional statements using conditional assignment.**
75. **Figure 3.18 The conditional move instructions.**
76. **Figure 3.19 Code for do-while version of factorial program.**



77. **Figure 3.20 C and assembly code for while version of factorial using jump-to-middle translation.**
78. **Figure 3.21 C and assembly code for while version of factorial using guarded-do translation.**
79. **Figure 3.22 Example switch statement and its translation into extended C.**
80. **Figure 3.23 Assembly code for switch statement example in Figure 3.22.**
81. **Figure 3.24 Assembly code and jump table for Problem 3.31.**
82. **Figure 3.25 General stack frame structure.**
83. **Figure 3.26 Illustration of call and ret functions.**
84. **Figure 3.27 Detailed execution of program involving procedure calls and returns.**
85. **Figure 3.28 Registers for passing function arguments.**
86. **Figure 3.29 Example of function with multiple arguments of different types.**
87. **Figure 3.30 Stack frame structure for function proc.**
88. **Figure 3.31 Example of procedure definition and call.**
89. **Figure 3.32 Example of code to call function proc, defined in Figure 3.29.**
90. **Figure 3.33 Stack frame for function call\_proc.**
91. **Figure 3.34 Code demonstrating use of callee-saved registers.**
92. **Figure 3.35 Code for recursive factorial program.**
93. **Figure 3.36 Elements of array in row-major order.**
94. **Figure 3.37 Original and optimized code to compute element i, k of matrix product for fixed-length arrays.**

95. **Figure 3.38 Original and optimized code to compute element  $i, k$  of matrix product for variable-size arrays.**
96. **Figure 3.39 Example gdb commands.**
97. **Figure 3.40 Stack organization for echo function.**
98. **Figure 3.41 C and disassembled code for Practice Problem 3.46.**
99. **Figure 3.42 Stack organization for echo function with stack protector enabled.**
100. **Figure 3.43 Function requiring the use of a frame pointer.**
101. **Figure 3.44 Stack frame structure for function vframe.**
102. **Figure 3.45 Media registers.**
103. **Figure 3.46 Floating-point movement instructions.**
104. **Figure 3.47 Two-operand floating-point conversion operations.**
105. **Figure 3.48 Three-operand floating-point conversion operations.**
106. **Figure 3.49 Scalar floating-point arithmetic operations.**
107. **Figure 3.50 Bitwise operations on packed data.**
108. **Figure 3.51 Illustration of conditional branching in floating-point code.**
109. **Figure 3.52 Assembly code for Problem 3.62.**
110. **Figure 3.53 Disassembled code for Problem 3.63.**
111. **Figure 3.54 Code for Problem 3.72.**
112. **Figure 4.1 Y86-64 programmer-visible state.**
113. **Figure 4.2 Y86-64 instruction set.**
114. **Figure 4.3 Function codes for Y86-64 instruction set.**
115. **Figure 4.4 Y86-64 program register identifiers.**
116. **Figure 4.5 Y86-64 status codes.**

117. **Figure 4.6 Comparison of Y86-64 and x86-64 assembly programs.**
118. **Figure 4.7 Sample program written in Y86-64 assembly code.**
119. **Figure 4.8 Output of yas assembler.**
120. **Figure 4.9 Logic gate types.**
121. **Figure 4.10 Combinational circuit to test for bit equality.**
122. **Figure 4.11 Single-bit multiplexor circuit.**
123. **Figure 4.12 Word-level equality test circuit.**
124. **Figure 4.13 Word-level multiplexor circuit.**
125. **Figure 4.14 Four-way multiplexor.**
126. **Figure 4.15 Arithmetic/logic unit (ALU).**
127. **Figure 4.16 Register operation.**
128. **Figure 4.17 Sample Y86-64 instruction sequence.**
129. **Figure 4.18 Computations in sequential implementation of Y86-64 instructions OPq, rrmovq, and irmovq.**
130. **Figure 4.19 Computations in sequential implementation of Y86-64 instructions rmmovq and mrmovq.**
131. **Figure 4.20 Computations in sequential implementation of Y86-64 instructions pushq and popq.**
132. **Figure 4.21 Computations in sequential implementation of Y86-64 instructions jXX, call, and ret.**
133. **Figure 4.22 Abstract view of SEQ, a sequential implementation.**
134. **Figure 4.23 Hardware structure of SEQ, a sequential implementation.**
135. **Figure 4.24 Identifying the different computation steps in the sequential implementation.**

136. **Figure 4.25** Tracing two cycles of execution by SEQ.
137. **Figure 4.26** Constant values used in HCL descriptions.
138. **Figure 4.27** SEQ fetch stage.
139. **Figure 4.28** SEQ decode and write-back stage.
140. **Figure 4.29** SEQ execute stage.
141. **Figure 4.30** SEQ memory stage.
142. **Figure 4.31** SEQ PC update stage.
143. **Figure 4.32** Unpipelined computation hardware.
144. **Figure 4.33** Three-stage pipelined computation hardware.
145. **Figure 4.34** Three-stage pipeline timing.
146. **Figure 4.35** One clock cycle of pipeline operation.
147. **Figure 4.36** Limitations of pipelining due to nonuniform stage delays.
148. **Figure 4.37** Limitations of pipelining due to overhead.
149. **Figure 4.38** Limitations of pipelining due to logical dependencies.
150. **Figure 4.39** Shifting the timing of the PC computation.
151. **Figure 4.40** SEQ+ hardware structure.
152. **Figure 4.41** Hardware structure of PIPE—, an initial pipelined implementation.
153. **Figure 4.42** Example of instruction flow through pipeline.
154. **Figure 4.43** Pipelined execution of prog1 without special pipeline control.
155. **Figure 4.44** Pipelined execution of prog2 without special pipeline control.
156. **Figure 4.45** Pipelined execution of prog3 without special pipeline control.

157. **Figure 4.46 Pipelined execution of prog4 without special pipeline control.**
158. **Figure 4.47 Pipelined execution of prog2 using stalls.**
159. **Figure 4.48 Pipelined execution of prog4 using stalls.**
160. **Figure 4.49 Pipelined execution of prog2 using forwarding.**
161. **Figure 4.50 Pipelined execution of prog3 using forwarding.**
162. **Figure 4.51 Pipelined execution of prog4 using forwarding.**
163. **Figure 4.52 Hardware structure of PIPE, our final pipelined implementation.**
164. **Figure 4.53 Example of load/use data hazard.**
165. **Figure 4.54 Handling a load/use hazard by stalling.**
166. **Figure 4.55 Simplified view of ret instruction processing.**
167. **Figure 4.56 Processing mispredicted branch instructions.**
168. **Figure 4.57 PIPE PC selection and fetch logic.**
169. **Figure 4.58 PIPE decode and write-back stage logic.**
170. **Figure 4.59 Demonstration of forwarding priority.**
171. **Figure 4.60 PIPE execute stage logic.**
172. **Figure 4.61 PIPE memory stage logic.**
173. **Figure 4.62 Detailed processing of the ret instruction.**
174. **Figure 4.63 Processing invalid memory reference exception.**
175. **Figure 4.64 Detection conditions for pipeline control logic.**
176. **Figure 4.65 Additional pipeline register operations,**
177. **Figure 4.66 Actions for pipeline control logic.**

178. **Figure 4.67 Pipeline states for special control conditions.**
179. **Figure 4.68 PIPE pipeline control logic.**
180. **Figure 4.69 Switch statements can be translated into Y86-64 code.**
181. **Figure 4.70 Execute and memory stages capable of load forwarding.**
182. **Figure 4.71 Solution for Problem 4.10.**
183. **Figure 5.1 Prefix-sum functions.**
184. **Figure 5.2 Performance of prefix-sum functions.**
185. **Figure 5.3 Vector abstract data type.**
186. **Figure 5.4 Implementation of vector abstract data type.**
187. **Figure 5.5 Initial implementation of combining operation.**
188. **Figure 5.6 Improving the efficiency of the loop test.**
189. **Figure 5.7 Lowercase conversion routines.**
190. **Figure 5.8 Comparative performance of lowercase conversion routines.**
191. **Figure 5.9 Eliminating function calls within the loop.**
192. **Figure 5.10 Accumulating result in temporary.**
193. **Figure 5.11 Block diagram of an out-of-order processor.**
194. **Figure 5.12 Latency, issue time, and capacity characteristics of reference machine operations.**
195. **Figure 5.13 Graphical representation of inner-loop code for combine4**
196. **Figure 5.14 Abstracting combine4 operations as a data-flow graph.**
197. **Figure 5.15 Data-flow representation of computation by  $n$  iterations of the inner loop of combine4.**
198. **Figure 5.16 Applying  $2 \times 1$  loop unrolling.**

199. **Figure 5.17 CPE performance for different degrees of  $k \times 1$  loop unrolling.**
200. **Figure 5.18 Graphical representation of inner-loop code for combine5.**
201. **Figure 5.19 Abstracting combine5 operations as a data-flow graph.**
202. **Figure 5.20 Data-flow representation of combine5 operating on a vector of length  $n$ .**
203. **Figure 5.21 Applying  $2 \times 2$  loop unrolling.**
204. **Figure 5.22 Graphical representation of inner-loop code for combine6.**
205. **Figure 5.23 Abstracting combine6 operations as a data-flow graph.**
206. **Figure 5.24 Data-flow representation of combine6 operating on a vector of length  $n$ .**
207. **Figure 5.25 CPE performance of  $k \times k$  loop unrolling.**
208. **Figure 5.26 Applying  $2 \times 1a$  unrolling.**
209. **Figure 5.27 Graphical representation of inner-loop code for combine7.**
210. **Figure 5.28 Abstracting combine7 operations as a data-flow graph.**
211. **Figure 5.29 Data-flow representation of combine7 operating on a vector of length  $n$ .**
212. **Figure 5.30 CPE performance for  $k \times 1a$  loop unrolling.**
213. **Figure 5.31 Linked list function.**
214. **Figure 5.32 Function to set array elements to 0.**
215. **Figure 5.33 Code to write and read memory locations, along with illustrative executions.**

216. **Figure 5.34** Detail of load and store units.
217. **Figure 5.35** Graphical representation of inner-loop code for `write_read`.
218. **Figure 5.36** Abstracting the operations for `write_read`.
219. **Figure 5.37** Data-flow representation of function `write_read`.
220. **Figure 5.38** Profile results for different versions of bigram-frequency counting program.
221. **Figure 5.39** Data dependencies among multiplication operations for cases in Problem 5.8.
222. **Figure 6.1** Inverted pendulum.
223. **Figure 6.2** Characteristics of DRAM and SRAM memory.
224. **Figure 6.3** High-level view of a 128-bit  $16 \times 8$  DRAM chip.
225. **Figure 6.4** Reading the contents of a DRAM supercell.
226. **Figure 6.5** Reading the contents of a memory module.
227. **Figure 6.6** Example bus structure that connects the CPU and main memory.
228. **Figure 6.7** Memory read transaction for a load operation:  
`movq A, %rax.`
229. **Figure 6.8** Memory write transaction for a store operation:  
`movq %rax, A.`
230. **Figure 6.9** Disk geometry.
231. **Figure 6.10** Disk dynamics.
232. **Figure 6.11** Example bus structure that connects the CPU, main memory, and I/O devices.
233. **Figure 6.12** Reading a disk sector.
234. **Figure 6.13** Solid state disk (SSD).



235. **Figure 6.14 Performance characteristics of a commercial solid state disk.**
236. **Figure 6.15 Storage and processing technology trends.**
237. **Figure 6.16 The gap between disk, DRAM, and CPU speeds.**
238. **Figure 6.17 (a) A function with good locality, (b) Reference pattern for vector  $v$  ( $N = 8$ ).**
239. **Figure 6.18 (a) Another function with good locality, (b) Reference pattern for array  $a$  ( $M = 2, N = 3$ ).**
240. **Figure 6.19 (a) A function with poor spatial locality, (b) Reference pattern for array  $a$  ( $M = 2, N = 3$ ).**
241. **Figure 6.20 Code examples for Practice Problem 6.8.**
242. **Figure 6.21 The memory hierarchy.**
243. **Figure 6.22 The basic principle of caching in a memory hierarchy.**
244. **Figure 6.23 The ubiquity of caching in modern computer systems.**
245. **Figure 6.24 Typical bus structure for cache memories.**
246. **Figure 6.25 General organization of cache ( $S, E, B, m$ ).**
247. **Figure 6.26 Summary of cache parameters.**
248. **Figure 6.27 Direct-mapped cache ( $E = 1$ ).**
249. **Figure 6.28 Set selection in a direct-mapped cache.**
250. **Figure 6.29 Line matching and word selection in a direct-mapped cache.**
251. **Figure 6.30 4-bit address space for example direct-mapped cache.**
252. **Figure 6.31 Why caches index with the middle bits.**
253. **Figure 6.32 Set associative cache ( $1 < E < C/B$ ).**

254. **Figure 6.33 Set selection in a set associative cache.**
255. **Figure 6.34 Line matching and word selection in a set associative cache.**
256. **Figure 6.35 Fully associative cache ( $E = C/B$ ).**
257. **Figure 6.36 Set selection in a fully associative cache.**
258. **Figure 6.37 Line matching and word selection in a fully associative cache.**
259. **Figure 6.38 Intel Core i7 cache hierarchy.**
260. **Figure 6.39 Characteristics of the Intel Core i7 cache hierarchy.**
261. **Figure 6.40 Functions that measure and compute read throughput.**
262. **Figure 6.41 A memory mountain.**
263. **Figure 6.42 Ridges of temporal locality in the memory mountain.**
264. **Figure 6.43 A slope of spatial locality.**
265. **Figure 6.44 Six versions of matrix multiply.**
266. **Figure 6.45 Analysis of matrix multiply inner loops.**
267. **Figure 6.46 Core i7 matrix multiply performance.**
268. **Figure 6.47 Functions referenced in Problem 6.37.**
269. **Figure 6.48 Figure for solution to Problem 6.17.**
270. **Figure 7.1 Example program 1.**
271. **Figure 7.2 Static linking.**
272. **Figure 7.3 Typical ELF relocatable object file.**
273. **Figure 7.4 ELF symbol table entry.**
274. **Figure 7.5 Example program for Practice Problem 7.1.**
275. **Figure 7.6 Member object files in the libvector library.**
276. **Figure 7.7 Example program 2.**

- 277. **Figure 7.8 Linking with static libraries.**
- 278. **Figure 7.9 ELF relocation entry.**
- 279. **Figure 7.10 Relocation algorithm.**
- 280. **Figure 7.11 Code and relocation entries from main.o.**
- 281. **Figure 7.12 Relocated .text and .data sections for the executable file prog.**
- 282. **Figure 7.13 Typical ELF executable object file.**
- 283. **Figure 7.14 Program header table for the example executable prog.**
- 284. **Figure 7.15 Linux x86-64 run-time memory image.**
- 285. **Figure 7.16 Dynamic linking with shared libraries.**
- 286. **Figure 7.17 Example program 3.**
- 287. **Figure 7.18 Using the GOT to reference a global variable.**
- 288. **Figure 7.19 Using the PLT and GOT to call external functions.**
- 289. **Figure 7.20 Compile-time interpositioning with the C preprocessor.**
- 290. **Figure 7.21 Link-time interpositioning with the --wrap flag.**
- 291. **Figure 7.22 Run-time interpositioning with LD\_PRELOAD.**
- 292. **Figure 8.1 Anatomy of an exception.**
- 293. **Figure 8.2 Exception table.**
- 294. **Figure 8.3 Generating the address of an exception handler.**
- 295. **Figure 8.4 Classes of exceptions.**
- 296. **Figure 8.5 Interrupt handling.**
- 297. **Figure 8.6 Trap handling.**
- 298. **Figure 8.7 Fault handling.**
- 299. **Figure 8.8 Abort handling.**

300. **Figure 8.9** Examples of exceptions in x86-64 systems.
301. **Figure 8.10** Examples of popular system calls in Linux x86-64 systems.
302. **Figure 8.11** Implementing the hello program directly with Linux system calls.
303. **Figure 8.12** Logical control flows.
304. **Figure 8.13** Process address space.
305. **Figure 8.14** Anatomy of a process context switch.
306. **Figure 8.15** Using fork to create a new process.
307. **Figure 8.16** Process graph for the example program in Figure 8.15.
308. **Figure 8.17** Process graph for a nested fork.
309. **Figure 8.18** Using the waitpid function to reap zombie children in no particular order.
310. **Figure 8.19** Using waitpid to reap zombie children in the order they were created.
311. **Figure 8.20** Organization of an argument list.
312. **Figure 8.21** Organization of an environment variable list.
313. **Figure 8.22** Typical organization of the user stack when a new program starts.
314. **Figure 8.23** The main routine for a simple shell program.
315. **Figure 8.24** eval evaluates the shell command line.
316. **Figure 8.25** parseline parses a line of input for the shell.
317. **Figure 8.26** Linux signals.
318. **Figure 8.27** Signal handling.
319. **Figure 8.28** Foreground and background process groups.
320. **Figure 8.29** Using the kill function to send a signal to a child.

321. **Figure 8.30** A program that uses a signal handler to catch a SIGINT signal.
322. **Figure 8.31** Handlers can be interrupted by other handlers.
323. **Figure 8.32** Temporarily blocking a signal from being received.
324. **Figure 8.33** Async-signal-safe functions.
325. **Figure 8.34** The Sio (Safe I/O) package for signal handlers.
326. **Figure 8.35** A safe version of the SICINT handler from Figure 8.30.
327. **Figure 8.36** signal1. This program is flawed because it assumes that signals are queued.
328. **Figure 8.37** signal2. An improved version of Figure 8.36 that correctly accounts for the fact that signals are not queued.
329. **Figure 8.38** Signal. A wrapper for sigaction that provides portable signal handling on Posix-compliant systems.
330. **Figure 8.39** A shell program with a subtle synchronization error.
331. **Figure 8.40** Using sigprocmask to synchronize processes.
332. **Figure 8.41** Waiting for a signal with a spin loop.
333. **Figure 8.42** Waiting for a signal with sigsuspend.
334. **Figure 8.43** Nonlocal jump example.
335. **Figure 8.44** A program that uses nonlocal jumps to restart itself when the user types Ctrl+C.
336. **Figure 8.45** Counter program referenced in Problem 8.23.

- 337. **Figure 8.46** Sample shell session for Problem 8.26.
- 338. **Figure 8.47** Process graph for Practice Problem 8.2.
- 339. **Figure 8.48** Process graph for Practice Problem 8.3.
- 340. **Figure 8.49** Process graph for Practice Problem 8.4.
- 341. **Figure 9.1** A system that uses physical addressing.
- 342. **Figure 9.2** A system that uses virtual addressing.
- 343. **Figure 9.3** How a VM system uses main memory as a cache.
- 344. **Figure 9.4** Page table.
- 345. **Figure 9.5** VM page hit.
- 346. **Figure 9.6** VM page fault (before).
- 347. **Figure 9.7** VM page fault (after).
- 348. **Figure 9.8** Allocating a new virtual page.
- 349. **Figure 9.9** How VM provides processes with separate address spaces.
- 350. **Figure 9.10** Using VM to provide page-level memory protection.
- 351. **Figure 9.11** Summary of address translation symbols.
- 352. **Figure 9.12** Address translation with a page table.
- 353. **Figure 9.13** Operational view of page hits and page faults.
- 354. **Figure 9.14** Integrating VM with a physically addressed cache.
- 355. **Figure 9.15** Components of a virtual address that are used to access the TLB.
- 356. **Figure 9.16** Operational view of a TLB hit and miss.
- 357. **Figure 9.17** A two-level page table hierarchy.
- 358. **Figure 9.18** Address translation with a k-level page table.
- 359. **Figure 9.19** Addressing for small memory system.

360. **Figure 9.20** TLB, page table, and cache for small memory system.
361. **Figure 9.21** The Core i7 memory system.
362. **Figure 9.22** Summary of Core i7 address translation.
363. **Figure 9.23** Format of level 1, level 2, and level 3 page table entries.
364. **Figure 9.24** Format of level 4 page table entries.
365. **Figure 9.25** Core i7 page table translation.
366. **Figure 9.26** The virtual memory of a Linux process.
367. **Figure 9.27** How Linux organizes virtual memory.
368. **Figure 9.28** Linux page fault handling.
369. **Figure 9.29** A shared object.
370. **Figure 9.30** A private copy-on-write object.
371. **Figure 9.31** How the loader maps the areas of the user address space.
372. **Figure 9.32** Visual interpretation of mmap arguments.
373. **Figure 9.33** The heap.
374. **Figure 9.34** Allocating and freeing blocks with malloc and free.
375. **Figure 9.35** Format of a simple heap block.
376. **Figure 9.36** Organizing the heap with an implicit free list.
377. **Figure 9.37** Splitting a free block to satisfy a three-word allocation request.
378. **Figure 9.38** An example of false fragmentation.
379. **Figure 9.39** Format of heap block that uses a boundary tag.
380. **Figure 9.40** Coalescing with boundary tags.
381. **Figure 9.41** memlib. c: Memory system model.

- 382. **Figure 9.42 Invariant form of the implicit free list.**
- 383. **Figure 9.43 Basic constants and macros for manipulating the free list.**
- 384. **Figure 9.44 mm\_init creates a heap with an initial free block.**
- 385. **Figure 9.45 extend\_heap extends the heap with a new free block.**
- 386. **Figure 9.46 mm\_free frees a block and uses boundary-tag coalescing to merge it with any adjacent free blocks in constant time.**
- 387. **Figure 9.47 mm\_malloc allocates a block from the free list.**
- 388. **Figure 9.48 Format of heap blocks that use doubly linked free lists.**
- 389. **Figure 9.49 A garbage collector's view of memory as a directed graph.**
- 390. **Figure 9.50 Integrating a conservative garbage collector and a C malloc package.**
- 391. **Figure 9.51 Pseudocode for the mark and sweep functions.**
- 392. **Figure 9.52 Mark&Sweep example.**
- 393. **Figure 9.53 Left and right pointers in a balanced tree of allocated blocks.**
- 394. **Figure 10.1 Portion of the Linux directory hierarchy.**
- 395. **Figure 10.2 Access permission bits.**
- 396. **Figure 10.3 Using read and write to copy standard input to standard output 1 byte at a time.**
- 397. **Figure 10.4 The rio\_readn and rio\_writen functions.**



- 398. **Figure 10.5 Copying a text file from standard input to standard output.**
- 399. **Figure 10.6 A read buffer of type `rio_t` and the `rio_readinitb` function that initializes it.**
- 400. **Figure 10.7 The internal `rio_read` function.**
- 401. **Figure 10.8 The `rio_readlineb` and `rio_readnb` functions.**
- 402. **Figure 10.9 The `stat` structure.**
- 403. **Figure 10.10 Querying and manipulating a file's `st_mode` bits.**
- 404. **Figure 10.11 Reading the contents of a directory.**
- 405. **Figure 10.12 Typical kernel data structures for open files.**
- 406. **Figure 10.13 File sharing.**
- 407. **Figure 10.14 How a child process inherits the parent's open files.**
- 408. **Figure 10.15 Kernel data structures after redirecting standard output by calling `dup2(4, 1)`.**
- 409. **Figure 10.16 Relationship between Unix I/O, standard I/O, and Rio.**
- 410. **Figure 11.1 A client-server transaction.**
- 411. **Figure 11.2 Hardware organization of a network host.**
- 412. **Figure 11.3 Ethernet segment.**
- 413. **Figure 11.4 Bridged Ethernet segments.**
- 414. **Figure 11.5 Conceptual view of a LAN.**
- 415. **Figure 11.6 A small internet.**
- 416. **Figure 11.7 How data travel from one host to another on an internet.**
- 417. **Figure 11.8 Hardware and software organization of an Internet application.**

- 418. **Figure 11.9 IP address structure.**
- 419. **Figure 11.10 Subset of the Internet domain name hierarchy.**
- 420. **Figure 11.11 Anatomy of an Internet connection.**
- 421. **Figure 11.12 Overview of network applications based on the sockets interface.**
- 422. **Figure 11.13 Socket address structures.**
- 423. **Figure 11.14 The roles of the listening and connected descriptors.**
- 424. **Figure 11.15 Data structure returned by getaddrinfo.**
- 425. **Figure 11.16 The addrinfo structure used by getaddrinfo.**
- 426. **Figure 11.17 Hostinfo displays the mapping of a domain name to its associated IP addresses.**
- 427. **Figure 11.18 open\_clientfd: Helper function that establishes a connection with a server.**
- 428. **Figure 11.19 open\_listenfd: Helper function that opens and returns a listening descriptor.**
- 429. **Figure 11.20 Echo client main routine.**
- 430. **Figure 11.21 Iterative echo server main routine.**
- 431. **Figure 11.22 echo function that reads and echoes text lines.**
- 432. **Figure 11.23 Example MIME types.**
- 433. **Figure 11.24 Example of an HTTP transaction that serves static content.**
- 434. **Figure 11.25 Some HTTP status codes.**
- 435. **Figure 11.26 Examples of CGI environment variables.**
- 436. **Figure 11.27 CGI program that sums two integers.**

- 437. **Figure 11.28** An HTTP transaction that serves dynamic HTML content.
- 438. **Figure 11.29** The Tiny Web server.
- 439. **Figure 11.30** Tiny doit handles one HTTP transaction.
- 440. **Figure 11.31** Tiny clienterror sends an error message to the client.
- 441. **Figure 11.32** Tiny read\_requesthdrs reads and ignores request headers.
- 442. **Figure 11.33** Tiny parse\_uri parses an HTTP URI.
- 443. **Figure 11.34** Tiny serve\_static serves static content to a client.
- 444. **Figure 11.35** Tiny serve\_dynamic serves dynamic content to a client.
- 445. **Figure 12.1 Step 1:** Server accepts connection request from client.
- 446. **Figure 12.2 Step 2:** Server forks a child process to service the client.
- 447. **Figure 12.3 Step 3:** Server accepts another connection request.
- 448. **Figure 12.4 Step 4:** Server forks another child to service the new client.
- 449. **Figure 12.5** Concurrent echo server based on processes.
- 450. **Figure 12.6** An iterative echo server that uses I/O multiplexing.
- 451. **Figure 12.7** State machine for a logical flow in a concurrent event-driven echo server.
- 452. **Figure 12.8** Concurrent echo server based on I/O multiplexing.

- 453. **Figure 12.9** `init_pool` initializes the pool of active clients.
- 454. **Figure 12.10** `add_client` adds a new client connection to the pool.
- 455. **Figure 12.11** `check_clients` services ready client connections.
- 456. **Figure 12.12** Concurrent thread execution.
- 457. **Figure 12.13** `hello.c`: The Pthreads "Hello, world!" program.
- 458. **Figure 12.14** Concurrent echo server based on threads.
- 459. **Figure 12.15** Example program that illustrates different aspects of sharing.
- 460. **Figure 12.16** `badcnt.c`: An improperly synchronized counter program.
- 461. **Figure 12.17** Assembly code for the counter loop (lines 40–41) in `badcnt.c`.
- 462. **Figure 12.18** Instruction orderings for the first loop iteration in `badcnt.c`.
- 463. **Figure 12.19** Progress graph for the first loop iteration of `badcnt.c`.
- 464. **Figure 12.20** An example trajectory.
- 465. **Figure 12.21** Safe and unsafe trajectories.
- 466. **Figure 12.22** Using semaphores for mutual exclusion.
- 467. **Figure 12.23** Producer-consumer problem.
- 468. **Figure 12.24** `sbuf_t`: Bounded buffer used by the `Sbuf` package.
- 469. **Figure 12.25** `Sbuf`: A package for synchronizing concurrent access to bounded buffers.
- 470. **Figure 12.26** Solution to the first readers-writers problem.

- 471. **Figure 12.27 Organization of a prethreaded concurrent server.**
- 472. **Figure 12.28 A prethreaded concurrent echo server.**
- 473. **Figure 12.29 echo\_cnt: A version of echo that counts all bytes received from clients.**
- 474. **Figure 12.30 Relationships between the sets of sequential, concurrent, and parallel programs.**
- 475. **Figure 12.31 Main routine for psum-mutex.**
- 476. **Figure 12.32 Thread routine for psum-mutex.**
- 477. **Figure 12.33 Thread routine for psum-array.**
- 478. **Figure 12.34 Thread routine for psum-local.**
- 479. **Figure 12.35 Performance of psum-local (Figure 12.34).**
- 480. **Figure 12.36 Speedup and parallel efficiency for the execution times in Figure 12.35.**
- 481. **Figure 12.37 A thread-unsafe pseudorandom number generator.**
- 482. **Figure 12.38 Thread-safe wrapper function for the C standard library ctime function.**
- 483. **Figure 12.39 Relationships between the sets of reentrant, thread-safe, and thread-unsafe functions.**
- 484. **Figure 12.40 rand\_r: A reentrant version of the rand function from Figure 12.37.**
- 485. **Figure 12.41 Common thread-unsafe library functions.**
- 486. **Figure 12.42 program with a race.**
- 487. **Figure 12.43**
- 488. **Figure 12.44 Progress graph for a program that can deadlock.**
- 489. **Figure 12.45 Progress graph for a deadlock-free program.**

- 490. **Figure 12.46 Buggy program for Problem 12.17.**
- 491. **Figure 12.47 Driver program for Problems 12.31–12.33.**
- 492. **Figure 12.48 Progress graph for a program that deadlocks.**
- 493. **Figure 12.49 Progress graph for the corrected deadlock-free program.**
- 494. **Figure A.1 Error-reporting functions.**
- 495. **Figure A.2 Wrapper for Unix-style wait function.**
- 496. **Figure A.3 Wrapper for Unix-style kill function.**
- 497. **Figure A.4 Wrapper for Posix-style pthread\_detach function.**
- 498. **Figure A.5 Wrapper for GAI-style getaddrinfo function.**

# Landmarks

1. **Contents**
2. **Frontmatter**
3. **Start of Content**
4. **backmatter**
5. **List of Illustrations**

1. **i**
2. **ii**
3. **iii**
4. **iv**
5. **v**
6. **vi**
7. **vii**
8. **viii**
9. **ix**
10. **x**
11. **xi**
12. **xii**
13. **xiii**
14. **xiv**
15. **xv**
16. **xvi**
17. **xvii**
18. **xviii**
19. **xix**
20. **xx**
21. **xxi**
22. **xxii**
23. **xxiii**
24. **xxiv**
25. **xxv**
26. **xxvi**
27. **xxvii**
28. **xxviii**



29. **xxix**
30. **xxx**
31. **xxxi**
32. **xxxii**
33. **xxxiii**
34. **xxxiv**
35. **xxxv**
36. **xxxvi**
37. **1**
38. **2**
39. **3**
40. **4**
41. **5**
42. **6**
43. **7**
44. **8**
45. **9**
46. **10**
47. **11**
48. **12**
49. **13**
50. **14**
51. **15**
52. **16**
53. **17**
54. **18**
55. **19**
56. **20**

- 57. **21**
- 58. **22**
- 59. **23**
- 60. **24**
- 61. **25**
- 62. **26**
- 63. **27**
- 64. **28**
- 65. **29**
- 66. **30**
- 67. **31**
- 68. **32**
- 69. **33**
- 70. **34**
- 71. **35**
- 72. **36**
- 73. **37**
- 74. **38**
- 75. **39**
- 76. **40**
- 77. **41**
- 78. **42**
- 79. **43**
- 80. **44**
- 81. **45**
- 82. **46**
- 83. **47**
- 84. **48**

- 85. **49**
- 86. **50**
- 87. **51**
- 88. **52**
- 89. **53**
- 90. **54**
- 91. **55**
- 92. **56**
- 93. **57**
- 94. **58**
- 95. **59**
- 96. **60**
- 97. **61**
- 98. **62**
- 99. **63**
- 100. **64**
- 101. **65**
- 102. **66**
- 103. **67**
- 104. **68**
- 105. **69**
- 106. **70**
- 107. **71**
- 108. **72**
- 109. **73**
- 110. **74**
- 111. **75**
- 112. **76**

113. **77**  
114. **78**  
115. **79**  
116. **80**  
117. **81**  
118. **82**  
119. **83**  
120. **84**  
121. **85**  
122. **86**  
123. **87**  
124. **88**  
125. **89**  
126. **90**  
127. **91**  
128. **92**  
129. **93**  
130. **94**  
131. **95**  
132. **96**  
133. **97**  
134. **98**  
135. **99**  
136. **100**  
137. **101**  
138. **102**  
139. **103**  
140. **104**

- 141. **105**
- 142. **106**
- 143. **107**
- 144. **108**
- 145. **109**
- 146. **110**
- 147. **111**
- 148. **112**
- 149. **113**
- 150. **114**
- 151. **115**
- 152. **116**
- 153. **117**
- 154. **118**
- 155. **119**
- 156. **120**
- 157. **121**
- 158. **122**
- 159. **123**
- 160. **124**
- 161. **125**
- 162. **126**
- 163. **127**
- 164. **128**
- 165. **129**
- 166. **130**
- 167. **131**
- 168. **132**

- 169. **133**
- 170. **134**
- 171. **135**
- 172. **136**
- 173. **137**
- 174. **138**
- 175. **139**
- 176. **140**
- 177. **141**
- 178. **142**
- 179. **143**
- 180. **144**
- 181. **145**
- 182. **146**
- 183. **147**
- 184. **148**
- 185. **149**
- 186. **150**
- 187. **151**
- 188. **152**
- 189. **153**
- 190. **154**
- 191. **155**
- 192. **156**
- 193. **157**
- 194. **158**
- 195. **159**
- 196. **160**

- 197. **161**
- 198. **162**
- 199. **163**
- 200. **164**
- 201. **165**
- 202. **166**
- 203. **167**
- 204. **168**
- 205. **169**
- 206. **170**
- 207. **171**
- 208. **172**
- 209. **173**
- 210. **174**
- 211. **175**
- 212. **176**
- 213. **177**
- 214. **178**
- 215. **179**
- 216. **180**
- 217. **181**
- 218. **182**
- 219. **183**
- 220. **184**
- 221. **185**
- 222. **186**
- 223. **187**
- 224. **188**

225. **189**  
226. **190**  
227. **191**  
228. **192**  
229. **193**  
230. **194**  
231. **195**  
232. **196**  
233. **197**  
234. **198**  
235. **199**  
236. **200**  
237. **201**  
238. **202**  
239. **203**  
240. **204**  
241. **205**  
242. **206**  
243. **207**  
244. **208**  
245. **209**  
246. **210**  
247. **211**  
248. **212**  
249. **213**  
250. **214**  
251. **215**  
252. **216**



- 253. **217**
- 254. **218**
- 255. **219**
- 256. **220**
- 257. **221**
- 258. **222**
- 259. **223**
- 260. **224**
- 261. **225**
- 262. **226**
- 263. **227**
- 264. **228**
- 265. **229**
- 266. **230**
- 267. **231**
- 268. **232**
- 269. **233**
- 270. **234**
- 271. **235**
- 272. **236**
- 273. **237**
- 274. **238**
- 275. **239**
- 276. **240**
- 277. **241**
- 278. **242**
- 279. **243**
- 280. **244**

- 281. **245**
- 282. **246**
- 283. **247**
- 284. **248**
- 285. **249**
- 286. **250**
- 287. **251**
- 288. **252**
- 289. **253**
- 290. **254**
- 291. **255**
- 292. **256**
- 293. **257**
- 294. **258**
- 295. **259**
- 296. **260**
- 297. **261**
- 298. **262**
- 299. **263**
- 300. **264**
- 301. **265**
- 302. **266**
- 303. **267**
- 304. **268**
- 305. **269**
- 306. **270**
- 307. **271**
- 308. **272**

- 309. **273**
- 310. **274**
- 311. **275**
- 312. **276**
- 313. **277**
- 314. **278**
- 315. **279**
- 316. **280**
- 317. **281**
- 318. **282**
- 319. **283**
- 320. **284**
- 321. **285**
- 322. **286**
- 323. **287**
- 324. **288**
- 325. **289**
- 326. **290**
- 327. **291**
- 328. **292**
- 329. **293**
- 330. **294**
- 331. **295**
- 332. **296**
- 333. **297**
- 334. **298**
- 335. **299**
- 336. **300**

337. **301**  
338. **302**  
339. **303**  
340. **304**  
341. **305**  
342. **306**  
343. **307**  
344. **308**  
345. **309**  
346. **310**  
347. **311**  
348. **312**  
349. **313**  
350. **314**  
351. **315**  
352. **316**  
353. **317**  
354. **318**  
355. **319**  
356. **320**  
357. **321**  
358. **322**  
359. **323**  
360. **324**  
361. **325**  
362. **326**  
363. **327**  
364. **328**

- 365. **329**
- 366. **330**
- 367. **331**
- 368. **332**
- 369. **333**
- 370. **334**
- 371. **335**
- 372. **336**
- 373. **337**
- 374. **338**
- 375. **339**
- 376. **340**
- 377. **341**
- 378. **342**
- 379. **343**
- 380. **344**
- 381. **345**
- 382. **346**
- 383. **347**
- 384. **348**
- 385. **349**
- 386. **350**
- 387. **351**
- 388. **352**
- 389. **353**
- 390. **354**
- 391. **355**
- 392. **356**

393. **357**  
394. **358**  
395. **359**  
396. **360**  
397. **361**  
398. **362**  
399. **363**  
400. **364**  
401. **365**  
402. **366**  
403. **367**  
404. **368**  
405. **369**  
406. **370**  
407. **371**  
408. **372**  
409. **373**  
410. **374**  
411. **375**  
412. **376**  
413. **377**  
414. **378**  
415. **379**  
416. **380**  
417. **381**  
418. **382**  
419. **383**  
420. **384**

- 421. **385**
- 422. **386**
- 423. **387**
- 424. **388**
- 425. **389**
- 426. **390**
- 427. **391**
- 428. **392**
- 429. **393**
- 430. **394**
- 431. **395**
- 432. **396**
- 433. **397**
- 434. **398**
- 435. **399**
- 436. **400**
- 437. **401**
- 438. **402**
- 439. **403**
- 440. **404**
- 441. **405**
- 442. **406**
- 443. **407**
- 444. **408**
- 445. **409**
- 446. **410**
- 447. **411**
- 448. **412**

449. **413**  
450. **414**  
451. **415**  
452. **416**  
453. **417**  
454. **418**  
455. **419**  
456. **420**  
457. **421**  
458. **422**  
459. **423**  
460. **424**  
461. **425**  
462. **426**  
463. **427**  
464. **428**  
465. **429**  
466. **430**  
467. **431**  
468. **432**  
469. **433**  
470. **434**  
471. **435**  
472. **436**  
473. **437**  
474. **438**  
475. **439**  
476. **440**



477. **441**  
478. **442**  
479. **443**  
480. **444**  
481. **445**  
482. **446**  
483. **447**  
484. **448**  
485. **449**  
486. **450**  
487. **451**  
488. **452**  
489. **453**  
490. **454**  
491. **455**  
492. **456**  
493. **457**  
494. **458**  
495. **459**  
496. **460**  
497. **461**  
498. **462**  
499. **463**  
500. **464**  
501. **465**  
502. **466**  
503. **467**  
504. **468**

505. **469**  
506. **470**  
507. **471**  
508. **472**  
509. **473**  
510. **474**  
511. **475**  
512. **476**  
513. **477**  
514. **478**  
515. **479**  
516. **480**  
517. **481**  
518. **482**  
519. **483**  
520. **484**  
521. **485**  
522. **486**  
523. **487**  
524. **488**  
525. **489**  
526. **490**  
527. **491**  
528. **492**  
529. **493**  
530. **494**  
531. **495**  
532. **496**

533. **497**  
534. **498**  
535. **499**  
536. **500**  
537. **501**  
538. **502**  
539. **503**  
540. **504**  
541. **505**  
542. **506**  
543. **507**  
544. **508**  
545. **509**  
546. **510**  
547. **511**  
548. **512**  
549. **513**  
550. **514**  
551. **515**  
552. **516**  
553. **517**  
554. **518**  
555. **519**  
556. **520**  
557. **521**  
558. **522**  
559. **523**  
560. **524**

- 561. **525**
- 562. **526**
- 563. **527**
- 564. **528**
- 565. **529**
- 566. **530**
- 567. **531**
- 568. **532**
- 569. **533**
- 570. **534**
- 571. **535**
- 572. **536**
- 573. **537**
- 574. **538**
- 575. **539**
- 576. **540**
- 577. **541**
- 578. **542**
- 579. **543**
- 580. **544**
- 581. **545**
- 582. **546**
- 583. **547**
- 584. **548**
- 585. **549**
- 586. **550**
- 587. **551**
- 588. **552**

- 589. **553**
- 590. **554**
- 591. **555**
- 592. **556**
- 593. **557**
- 594. **558**
- 595. **559**
- 596. **560**
- 597. **561**
- 598. **562**
- 599. **563**
- 600. **564**
- 601. **565**
- 602. **566**
- 603. **567**
- 604. **568**
- 605. **569**
- 606. **570**
- 607. **571**
- 608. **572**
- 609. **573**
- 610. **574**
- 611. **575**
- 612. **576**
- 613. **577**
- 614. **578**
- 615. **579**
- 616. **580**

617. **581**  
618. **582**  
619. **583**  
620. **584**  
621. **585**  
622. **586**  
623. **587**  
624. **588**  
625. **589**  
626. **590**  
627. **591**  
628. **592**  
629. **593**  
630. **594**  
631. **595**  
632. **596**  
633. **597**  
634. **598**  
635. **599**  
636. **600**  
637. **601**  
638. **602**  
639. **603**  
640. **604**  
641. **605**  
642. **606**  
643. **607**  
644. **608**

645. **609**  
646. **610**  
647. **611**  
648. **612**  
649. **613**  
650. **614**  
651. **615**  
652. **616**  
653. **617**  
654. **618**  
655. **619**  
656. **620**  
657. **621**  
658. **622**  
659. **623**  
660. **624**  
661. **625**  
662. **626**  
663. **627**  
664. **628**  
665. **629**  
666. **630**  
667. **631**  
668. **632**  
669. **633**  
670. **634**  
671. **635**  
672. **636**

673. **637**  
674. **638**  
675. **639**  
676. **640**  
677. **641**  
678. **642**  
679. **643**  
680. **644**  
681. **645**  
682. **646**  
683. **647**  
684. **648**  
685. **649**  
686. **650**  
687. **651**  
688. **652**  
689. **653**  
690. **654**  
691. **655**  
692. **656**  
693. **657**  
694. **658**  
695. **659**  
696. **660**  
697. **661**  
698. **662**  
699. **663**  
700. **664**



701. **665**  
702. **666**  
703. **667**  
704. **668**  
705. **669**  
706. **670**  
707. **671**  
708. **672**  
709. **673**  
710. **674**  
711. **675**  
712. **676**  
713. **677**  
714. **678**  
715. **679**  
716. **680**  
717. **681**  
718. **682**  
719. **683**  
720. **684**  
721. **685**  
722. **686**  
723. **687**  
724. **688**  
725. **689**  
726. **690**  
727. **691**  
728. **692**

729. **693**  
730. **694**  
731. **695**  
732. **696**  
733. **697**  
734. **698**  
735. **699**  
736. **700**  
737. **701**  
738. **702**  
739. **703**  
740. **704**  
741. **705**  
742. **706**  
743. **707**  
744. **708**  
745. **709**  
746. **710**  
747. **711**  
748. **712**  
749. **713**  
750. **714**  
751. **715**  
752. **716**  
753. **717**  
754. **718**  
755. **719**  
756. **720**

757. **721**  
758. **722**  
759. **723**  
760. **724**  
761. **725**  
762. **726**  
763. **727**  
764. **728**  
765. **729**  
766. **730**  
767. **731**  
768. **732**  
769. **733**  
770. **734**  
771. **735**  
772. **736**  
773. **737**  
774. **738**  
775. **739**  
776. **740**  
777. **741**  
778. **742**  
779. **743**  
780. **744**  
781. **745**  
782. **746**  
783. **747**  
784. **748**

785. **749**  
786. **750**  
787. **751**  
788. **752**  
789. **753**  
790. **754**  
791. **755**  
792. **756**  
793. **757**  
794. **758**  
795. **759**  
796. **760**  
797. **761**  
798. **762**  
799. **763**  
800. **764**  
801. **765**  
802. **766**  
803. **767**  
804. **768**  
805. **769**  
806. **770**  
807. **771**  
808. **772**  
809. **773**  
810. **774**  
811. **775**  
812. **776**

813. **777**  
814. **778**  
815. **779**  
816. **780**  
817. **781**  
818. **782**  
819. **783**  
820. **784**  
821. **785**  
822. **786**  
823. **787**  
824. **788**  
825. **789**  
826. **790**  
827. **791**  
828. **792**  
829. **793**  
830. **794**  
831. **795**  
832. **796**  
833. **797**  
834. **798**  
835. **799**  
836. **800**  
837. **801**  
838. **802**  
839. **803**  
840. **804**

841. **805**  
842. **806**  
843. **807**  
844. **808**  
845. **809**  
846. **810**  
847. **811**  
848. **812**  
849. **813**  
850. **814**  
851. **815**  
852. **816**  
853. **817**  
854. **818**  
855. **819**  
856. **820**  
857. **821**  
858. **822**  
859. **823**  
860. **824**  
861. **825**  
862. **826**  
863. **827**  
864. **828**  
865. **829**  
866. **830**  
867. **831**  
868. **832**

869. **833**  
870. **834**  
871. **835**  
872. **836**  
873. **837**  
874. **838**  
875. **839**  
876. **840**  
877. **841**  
878. **842**  
879. **843**  
880. **844**  
881. **845**  
882. **846**  
883. **847**  
884. **848**  
885. **849**  
886. **850**  
887. **851**  
888. **852**  
889. **853**  
890. **854**  
891. **855**  
892. **856**  
893. **857**  
894. **858**  
895. **859**  
896. **860**

897. **861**  
898. **862**  
899. **863**  
900. **864**  
901. **865**  
902. **866**  
903. **867**  
904. **868**  
905. **869**  
906. **870**  
907. **871**  
908. **872**  
909. **873**  
910. **874**  
911. **875**  
912. **876**  
913. **877**  
914. **878**  
915. **879**  
916. **880**  
917. **881**  
918. **882**  
919. **883**  
920. **884**  
921. **885**  
922. **886**  
923. **887**  
924. **888**



925. **889**  
926. **890**  
927. **891**  
928. **892**  
929. **893**  
930. **894**  
931. **895**  
932. **896**  
933. **897**  
934. **898**  
935. **899**  
936. **900**  
937. **901**  
938. **902**  
939. **903**  
940. **904**  
941. **905**  
942. **906**  
943. **907**  
944. **908**  
945. **909**  
946. **910**  
947. **911**  
948. **912**  
949. **913**  
950. **914**  
951. **915**  
952. **916**

953. **917**  
954. **918**  
955. **919**  
956. **920**  
957. **921**  
958. **922**  
959. **923**  
960. **924**  
961. **925**  
962. **926**  
963. **927**  
964. **928**  
965. **929**  
966. **930**  
967. **931**  
968. **932**  
969. **933**  
970. **934**  
971. **935**  
972. **936**  
973. **937**  
974. **938**  
975. **939**  
976. **940**  
977. **941**  
978. **942**  
979. **943**  
980. **944**

981. **945**  
982. **946**  
983. **947**  
984. **948**  
985. **949**  
986. **950**  
987. **951**  
988. **952**  
989. **953**  
990. **954**  
991. **955**  
992. **956**  
993. **957**  
994. **958**  
995. **959**  
996. **960**  
997. **961**  
998. **962**  
999. **963**  
1000. **964**  
1001. **965**  
1002. **966**  
1003. **967**  
1004. **968**  
1005. **969**  
1006. **970**  
1007. **971**  
1008. **972**

1009. **973**  
1010. **974**  
1011. **975**  
1012. **976**  
1013. **977**  
1014. **978**  
1015. **979**  
1016. **980**  
1017. **981**  
1018. **982**  
1019. **983**  
1020. **984**  
1021. **985**  
1022. **986**  
1023. **987**  
1024. **988**  
1025. **989**  
1026. **990**  
1027. **991**  
1028. **992**  
1029. **993**  
1030. **994**  
1031. **995**  
1032. **996**  
1033. **997**  
1034. **998**  
1035. **999**  
1036. **1000**

1037. **1001**  
1038. **1002**  
1039. **1003**  
1040. **1004**  
1041. **1005**  
1042. **1006**  
1043. **1007**  
1044. **1008**  
1045. **1009**  
1046. **1010**  
1047. **1011**  
1048. **1012**  
1049. **1013**  
1050. **1014**  
1051. **1015**  
1052. **1016**  
1053. **1017**  
1054. **1018**  
1055. **1019**  
1056. **1020**  
1057. **1021**  
1058. **1022**  
1059. **1023**  
1060. **1024**  
1061. **1025**  
1062. **1026**  
1063. **1027**  
1064. **1028**

1065. **1029**  
1066. **1030**  
1067. **1031**  
1068. **1032**  
1069. **1033**  
1070. **1034**  
1071. **1035**  
1072. **1036**  
1073. **1037**  
1074. **1038**  
1075. **1039**  
1076. **1040**  
1077. **1041**  
1078. **1042**  
1079. **1043**  
1080. **1044**  
1081. **1045**  
1082. **1046**  
1083. **1047**  
1084. **1048**  
1085. **1049**  
1086. **1050**  
1087. **1051**  
1088. **1052**  
1089. **1053**  
1090. **1054**  
1091. **1055**  
1092. **1056**

1093. **1057**  
1094. **1058**  
1095. **1059**  
1096. **1060**  
1097. **1061**  
1098. **1062**  
1099. **1063**  
1100. **1064**  
1101. **1065**  
1102. **1066**  
1103. **1067**  
1104. **1068**  
1105. **1069**  
1106. **1070**  
1107. **1071**  
1108. **1072**  
1109. **1073**  
1110. **1074**  
1111. **1075**  
1112. **1076**  
1113. **1077**  
1114. **1078**  
1115. **1079**  
1116. **1080**  
1117. **1081**  
1118. **1082**  
1119. **1083**  
1120. **1084**

[OceanofPDF.com](http://OceanofPDF.com)